

Hermetic, 50 mil Pitch, Leadless Thin Film Chip Resistor, Surface Mount Network

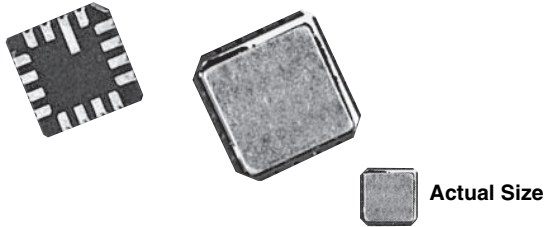

Vishay Dale Thin Film offers a wide resistance range in 16, 20, and 24 terminal hermetic leadless chip carriers. The standard circuits in the ohmic ranges listed below will utilize the outstanding wraparound terminations developed for chip resistors. Should one of the standards not fit your application, consult the applications engineering group as we may be able to meet your requirements.

FEATURES

- High purity alumina substrate for high power dissipation
- Leach resistant terminations with nickel barrier
- 16, 20, 24 terminal gold plated wraparound true hermetic packaging
- Military/aerospace
- Hermetically sealed
- Isolated/bussed circuits
- Ideal for military/aerospace applications
- Compliant to RoHS Directive 2002/95/EC
- Halogen-free according to IEC 61249-2-21 definition



RoHS*
COMPLIANT
HALOGEN
FREE

Note

- * Pb containing terminations are not RoHS compliant, exemptions may apply

TYPICAL PERFORMANCE

	ABSOLUTE	TRACKING
TCR	25	5
	ABSOLUTE	RATIO
TOL.	0.1	NA

Note

- Resistance range: Noted on schematics

SCHEMATIC

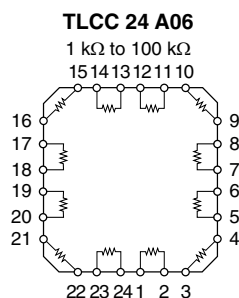
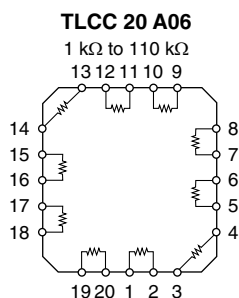
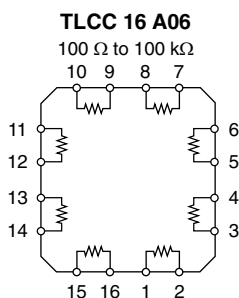
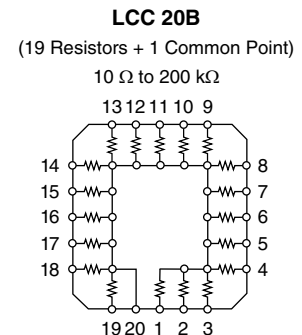
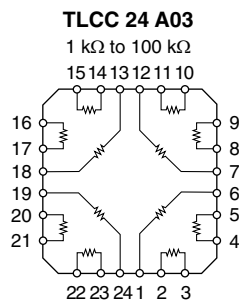
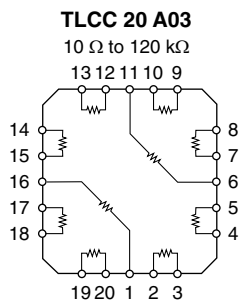
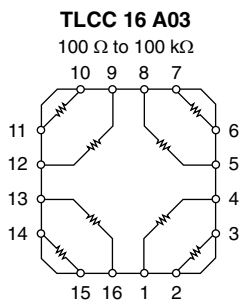
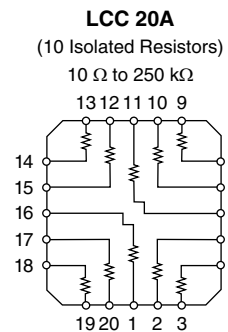
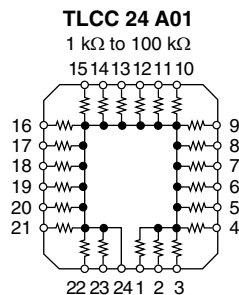
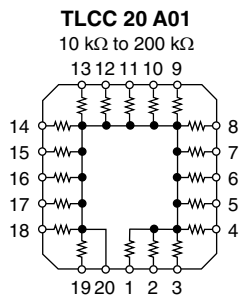
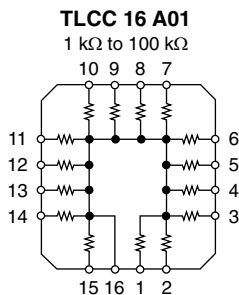

STANDARD ELECTRICAL SPECIFICATIONS		
TEST	SPECIFICATIONS	CONDITIONS
Material	Passivated nichrome	-
Pin/Lead Number	16, 20, 24	-
Resistance Range	10 Ω to 250 kΩ per resistor	-
TCR: Absolute	± 25 ppm/°C to ± 300 ppm/°C	- 55 °C to + 125 °C
TCR: Tracking	± 5 ppm/°C	- 55 °C to + 125 °C
Tolerance: Absolute	± 0.1 % to ± 1.0 %	+ 25 °C
Tolerance: Ratio	N/a	-
Power Rating: Resistor	50 mW max. = common circuits 100 mW max. = isolated circuits	Maximum at + 70 °C
Power Rating: Package	500 mW	Maximum at + 70 °C
Stability: Absolute	$\Delta R \pm 0.05 \%$	2000 h at + 70 °C
Stability: Ratio	-	-
Voltage Coefficient	< 5 ppm/V (typical)	-
Working Voltage	100 V max. not to exceed $\sqrt{P \times R}$	-
Operating Temperature Range	- 55 °C to + 125 °C	-
Storage Temperature Range	- 55 °C to + 150 °C	-
Noise	< - 30 dB	-
Thermal EMF	0.008 μV/°C	-
Shelf Life Stability: Absolute	$\Delta R \pm 0.01 \%$	1 year at + 25 °C
Shelf Life Stability: Ratio	-	-

Note

- Tantalum nitride film is custom, consult factory

DIMENSIONS in inches and millimeters						
DIMENSION	16 PINS		20 PINS		24 PINS	
	INCHES	MILLIMETERS	INCHES	MILLIMETERS	INCHES	MILLIMETERS
A	0.050	1.27	0.050	1.27	0.050	1.27
B	0.300	7.26	0.350	8.89	0.400	10.16
C	0.300	7.26	0.350	8.89	0.400	10.16
D	0.077	1.96	0.077	1.96	0.077	1.96
E	0.025	0.635	0.025	0.635	0.025	0.635
F	0.050	1.27	0.050	1.27	0.050	1.27
G	0.040	1.02	0.040	1.02	0.040	1.02
H	0.020	0.508	0.020	0.508	0.020	0.508



MECHANICAL SPECIFICATIONS	
Resistive Element	Passivated nichrome
Substrate Material	Alumina
Body	Ceramic
Terminals	Gold over nickel
Marking Resistance to Solvents	Per MIL-PRF-83401
Tin Lead Option	Sn63
Lead (Pb)-free Option	96.5 % Sn, 3.0 % Ag, 0.5 % Cu
Tin Lead and Lead (Pb)-free	Hot solder dip

GLOBAL PART NUMBER INFORMATION																	
New Global Part Numbering: TLCC20AE1002BUF																	
T	L	C	C	2	0	A	E	1	0	0	2	B	U	F			
T	L	C	C	T	1	6	A	0	1	K	1	0	0	3	K	U	F
GLOBAL MODEL (4 or 5 digits)	TERMINAL COUNT ⁽¹⁾	SCHEMATICS (4 or 5 digits)	TCR CHARACTERISTICS	RESISTANCE	TOLERANCE	PACKAGING											
LCC (Tin lead)	20	A = Isolated resistors B = Resistor to common bus	E = 25 ppm/°C H = 50 ppm/°C K = 100 ppm/°C M = 300 ppm/°C	First 3 digits are significant figures and the last digit specifies the number of zeros to follow. Example: 10R0 = 10 Ω 12R5 = 12.5 Ω 1000 = 100 Ω 1001 = 1000 Ω	B = 0.1 % D = 0.5 % F = 1 % G = 2 % J = 5 % K = 10 % S = Special	TAPE AND REEL T0 = 100 min., 100 mult T1 = 1000 min., 1000 mult T3 = 300 min., 300 mult T5 = 500 min., 500 mult TF = Full reel 2000 TS = 100 min., 1 mult UF = TUBED											
LCCT (Lead (Pb)-free) (e1)	20																
TLCC (Tin lead)	16 20 24	A01 = Resistor to common bus A03 = Isolated parallel resistor A06 = Isolated adjacent resistor															
TLCCCT (Lead (Pb)-free) (e1)	16 20 24																
Historical Part Number example: LC20BK1003J (for reference purposes only)																	
LC	20	B	K	1003	J												
SERIES	PINS	SCHEMATIC	TCR CHARACTERISTIC	RESISTANCE	TOLERANCE												

Note

⁽¹⁾ LCC or LCCT only available in 20 pin size



Disclaimer

ALL PRODUCT, PRODUCT SPECIFICATIONS AND DATA ARE SUBJECT TO CHANGE WITHOUT NOTICE TO IMPROVE RELIABILITY, FUNCTION OR DESIGN OR OTHERWISE.

Vishay Intertechnology, Inc., its affiliates, agents, and employees, and all persons acting on its or their behalf (collectively, "Vishay"), disclaim any and all liability for any errors, inaccuracies or incompleteness contained in any datasheet or in any other disclosure relating to any product.

Vishay makes no warranty, representation or guarantee regarding the suitability of the products for any particular purpose or the continuing production of any product. To the maximum extent permitted by applicable law, Vishay disclaims (i) any and all liability arising out of the application or use of any product, (ii) any and all liability, including without limitation special, consequential or incidental damages, and (iii) any and all implied warranties, including warranties of fitness for particular purpose, non-infringement and merchantability.

Statements regarding the suitability of products for certain types of applications are based on Vishay's knowledge of typical requirements that are often placed on Vishay products in generic applications. Such statements are not binding statements about the suitability of products for a particular application. It is the customer's responsibility to validate that a particular product with the properties described in the product specification is suitable for use in a particular application. Parameters provided in datasheets and/or specifications may vary in different applications and performance may vary over time. All operating parameters, including typical parameters, must be validated for each customer application by the customer's technical experts. Product specifications do not expand or otherwise modify Vishay's terms and conditions of purchase, including but not limited to the warranty expressed therein.

Except as expressly indicated in writing, Vishay products are not designed for use in medical, life-saving, or life-sustaining applications or for any other application in which the failure of the Vishay product could result in personal injury or death. Customers using or selling Vishay products not expressly indicated for use in such applications do so at their own risk. Please contact authorized Vishay personnel to obtain written terms and conditions regarding products designed for such applications.

No license, express or implied, by estoppel or otherwise, to any intellectual property rights is granted by this document or by any conduct of Vishay. Product names and markings noted herein may be trademarks of their respective owners.

Material Category Policy

Vishay Intertechnology, Inc. hereby certifies that all its products that are identified as RoHS-Compliant fulfill the definitions and restrictions defined under Directive 2011/65/EU of The European Parliament and of the Council of June 8, 2011 on the restriction of the use of certain hazardous substances in electrical and electronic equipment (EEE) - recast, unless otherwise specified as non-compliant.

Please note that some Vishay documentation may still make reference to RoHS Directive 2002/95/EC. We confirm that all the products identified as being compliant to Directive 2002/95/EC conform to Directive 2011/65/EU.

Vishay Intertechnology, Inc. hereby certifies that all its products that are identified as Halogen-Free follow Halogen-Free requirements as per JEDEC JS709A standards. Please note that some Vishay documentation may still make reference to the IEC 61249-2-21 definition. We confirm that all the products identified as being compliant to IEC 61249-2-21 conform to JEDEC JS709A standards.

Компания «Life Electronics» занимается поставками электронных компонентов импортного и отечественного производства от производителей и со складов крупных дистрибьюторов Европы, Америки и Азии.

С конца 2013 года компания активно расширяет линейку поставок компонентов по направлению коаксиальный кабель, кварцевые генераторы и конденсаторы (керамические, пленочные, электролитические), за счёт заключения дистрибьюторских договоров

Мы предлагаем:

- Конкурентоспособные цены и скидки постоянным клиентам.
- Специальные условия для постоянных клиентов.
- Подбор аналогов.
- Поставку компонентов в любых объемах, удовлетворяющих вашим потребностям.
- Приемлемые сроки поставки, возможна ускоренная поставка.
- Доставку товара в любую точку России и стран СНГ.
- Комплексную поставку.
- Работу по проектам и поставку образцов.
- Формирование склада под заказчика.
- Сертификаты соответствия на поставляемую продукцию (по желанию клиента).
- Тестирование поставляемой продукции.
- Поставку компонентов, требующих военную и космическую приемку.
- Входной контроль качества.
- Наличие сертификата ISO.

В составе нашей компании организован Конструкторский отдел, призванный помогать разработчикам, и инженерам.

Конструкторский отдел помогает осуществить:

- Регистрацию проекта у производителя компонентов.
- Техническую поддержку проекта.
- Защиту от снятия компонента с производства.
- Оценку стоимости проекта по компонентам.
- Изготовление тестовой платы монтаж и пусконаладочные работы.



Тел: +7 (812) 336 43 04 (многоканальный)
Email: org@lifeelectronics.ru