

THIS DRAWING IS UNPUBLISHED. RELEASED FOR PUBLICATION AUG ,2006.

© COPYRIGHT BY TYCO ELECTRONICS CORPORATION. ALL RIGHTS RESERVED.

LOC	DIST	REVISIONS			
P	LTR	DESCRIPTION	DATE	DWN	APVD
		E1	REVISED. ECR-12-013026	25MAR13	K.M E.T

- MATERIALS:**
HOUSING- PPA RESIN, BLACK, MOLDING COMPOUND.
CONTACTS- PHOSPHOR BRONZE PLATED WITH MINIMUM THICK (SEE TABLE) GOLD IN CONTACT AREA AND 3.8μm [.000150] MINIMUM THICK MATTE TIN ON SOLDER TINES OVER 1.27μm [.000050] MINIMUM THICK NICKEL UNDERPLATE.
RETENTION LEG- BRASS PLATED WITH 3.8μm [.000150] MINIMUM TIN-Cu OVER 1.3μm [.000051] MINIMUM NICKEL UNDERPLATE.
- G, J, AND H INDICATE NUMBER OF POSITION MARKED ON ASSEMBLY. ALSO SEE TABLE.
ALL DIMENSIONS SHOWN ARE MAXIMUM UNLESS OTHERWISE SPECIFIED.
4. 60 POSITION AS SHOWN.
RETENTION LEGS NOT PRESENT.
TOP OF RETENTION LEG MAY NOT PROTRUDE ABOVE THIS SURFACE.
HOUSING BOW UP TO 0.30 [.012] ALLOWED.
CONNECTOR WILL ACCOMMODATE MATING PRINTED CIRCUIT BOARD OF 1.6±0.07 [.063±.003] THICKNESS.
9. ALWAYS RoHS/ELV COMPLIANT.
10. WAVE SOLDER CAPABLE TO 265 C PER TE SPEC 109-202, CONDITION B.
REMOVE CONTACT POSITION FROM #11~#17 AND #36~#42.
RECOMMEND CARD EDGE DIM. (PAGE2)
GOLD FLASH OVER 0.762μm [30μ"] MIN. PALLADIUM-NICKEL PLATED.
OBSOLETE

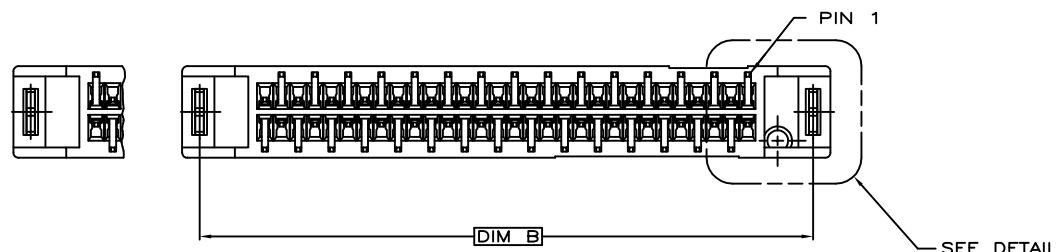
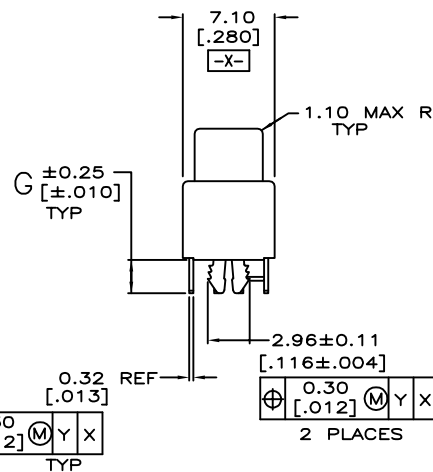
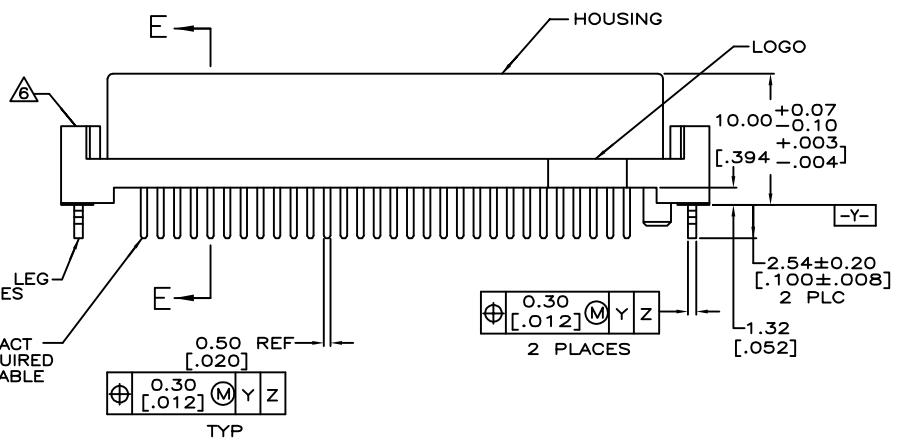
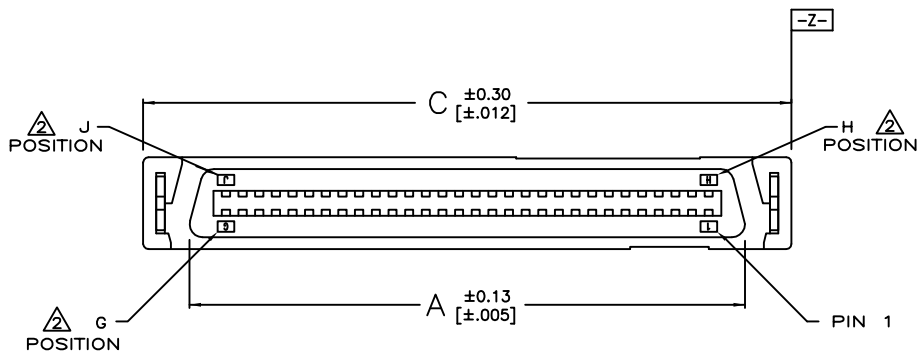
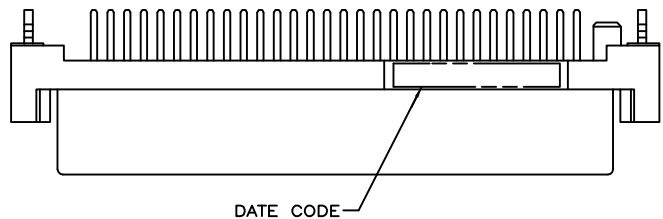

LOC	DIST	P	LTR	DESCRIPTION	DATE	DWN	APVD
E1				GOLD FLASH	5-1734101-6		
E1		2.36	3.30	127.43	138.35	135.71	131.27
E1		[.093]	[.130]	[5.017]	[5.447]	[5.343]	[5.168]
E1				0.381um[15u"]	3-1734101-6		
E1					1-1734101-6		
E1		0.8-1.6	2.54	127.43	138.35	135.71	131.27
E1		[.031-.063]	[.100]	[5.017]	[5.447]	[5.343]	[5.168]
E1				0.381um[15u"]	3-1734101-5		
E1					1-1734101-5		
E1		0.8-1.6	2.54	102.03	112.95	110.31	105.87
E1		[.031-.063]	[.100]	[4.017]	[4.447]	[4.343]	[4.168]
E1				GOLD FLASH	5-1734101-4		
E1				0.381um[15u"]	3-1734101-4		
E1					1-1734101-4		
E1		2.36	3.30	76.63	87.55	84.91	80.47
E1		[.093]	[.130]	[3.017]	[3.447]	[3.343]	[3.168]
E1				GOLD FLASH	5-1734101-3		
E1				0.381um[15u"]	3-1734101-3		
E1					1-1734101-3		
E1		0.8-1.6	2.54	76.63	87.55	84.91	80.47
E1		[.031-.063]	[.100]	[3.017]	[3.447]	[3.343]	[3.168]
E1				GOLD FLASH	5-1734101-2		
E1				0.381um[15u"]	3-1734101-2		
E1					1-1734101-2		
E1		2.36	3.30	63.93	74.85	72.21	67.77
E1		[.093]	[.130]	[2.517]	[2.947]	[2.843]	[2.668]
E1				GOLD FLASH	5-1734101-1		
E1				0.381um[15u"]	3-1734101-1		
E1					1-1734101-1		
E1		0.8-1.6	2.54	63.93	74.85	72.21	67.77
E1		[.031-.063]	[.100]	[2.517]	[2.947]	[2.843]	[2.668]
E1				GOLD FLASH	5-1734101-0		
E1				0.381um[15u"]	3-1734101-0		
E1					1-1734101-0		
E1		0.8-1.6	2.54	51.23	62.15	59.51	55.07
E1		[.031-.063]	[.100]	[2.017]	[2.447]	[2.343]	[2.168]
E1				GOLD FLASH	5-1734101-8		
E1				0.381um[15u"]	3-1734101-8		
E1					1-1734101-8		
E1		2.36	3.30	51.23	62.15	59.51	55.07
E1		[.093]	[.130]	[2.017]	[2.447]	[2.343]	[2.168]
E1				GOLD FLASH	4-1734101-9		
E1				0.381um[15u"]	6-1734101-9		
E1					1734101-9		
E1		0.8-1.6	2.54	51.23	62.15	59.51	55.07
E1		[.031-.063]	[.100]	[2.017]	[2.447]	[2.343]	[2.168]
E1				GOLD FLASH	4-1734101-8		
E1				0.381um[15u"]	6-1734101-8		
E1					1734101-8		
E1		0.8-1.6	2.54	43.61	54.53	51.89	47.45
E1		[.031-.063]	[.100]	[1.717]	[2.147]	[2.043]	[1.868]
E1				GOLD FLASH	4-1734101-7		
E1				0.381um[15u"]	6-1734101-7		
E1					1734101-7		
E1		2.36	3.40	38.53	49.45	46.81	42.37
E1		[.093]	[.134]	[1.517]	[1.947]	[1.843]	[1.668]
E1				GOLD FLASH	4-1734101-6		
E1				0.381um[15u"]	6-1734101-6		
E1					1734101-6		
E1		2.36	3.30	32.18	43.10	40.46	36.02
E1		[.093]	[.100]	[1.267]	[1.697]	[1.593]	[1.418]
E1				GOLD FLASH	5-1734101-7		
E1				0.381um[15u"]	3-1734101-7		
E1					1-1734101-7		
E1		0.8-1.6	2.54	32.18	43.10	40.46	36.02
E1		[.031-.063]	[.100]	[1.267]	[1.697]	[1.593]	[1.418]
E1				GOLD FLASH	4-1734101-5		
E1				0.381um[15u"]	6-1734101-5		
E1					1734101-5		
E1		0.8-1.6	2.54	25.83	36.75	34.11	29.67
E1		[.031-.063]	[.100]	[1.017]	[1.447]	[1.343]	[1.168]
E1				GOLD FLASH	4-1734101-4		
E1				0.381um[15u"]	6-1734101-4		
E1					1734101-4		
E1		0.8-1.6	2.54	-	30.40	27.96	23.32
E1		[.031-.063]	[.100]	-	[1.197]	[1.101]	[.918]
E1				GOLD FLASH	4-1734101-3		
E1				0.381um[15u"]	6-1734101-3		
E1					1734101-3		

THIS DRAWING IS A CONTROLLED DOCUMENT.

DIMENSIONS: MM

TOLERANCES UNLESS OTHERWISE SPECIFIED:

0 PLC	± -
1 PLC	± -
2 PLC	± -
3 PLC	± -
4 PLC	± -
ANGLES	± -

MATERIAL: SEE NOTE

FINISH: SEE NOTE

TE Connectivity

RECEPTACLE ASSEMBLY, VERTICAL, BOARD-TO-BOARD, CHAMP.050, SERIES I,

108-57876

QUALIFICATION TEST REPORT

SIZE: A3

CAGE CODE: 00779

DRAWING NO: C=1734101

RESTRICTED TO

CUSTOMER DRAWING

SCALE: -

SHEET: 1 OF 4

REV: E1

4

3

2

1

THIS DRAWING IS UNPUBLISHED. RELEASED FOR PUBLICATION AUG .2006.
 © COPYRIGHT - BY TYCO ELECTRONICS CORPORATION. ALL RIGHTS RESERVED.

LOC	DIST	REVISIONS					
DW		P	LTR	DESCRIPTION	DATE	DWN	APVD
				SEE SHEET 1.			

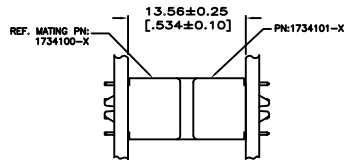
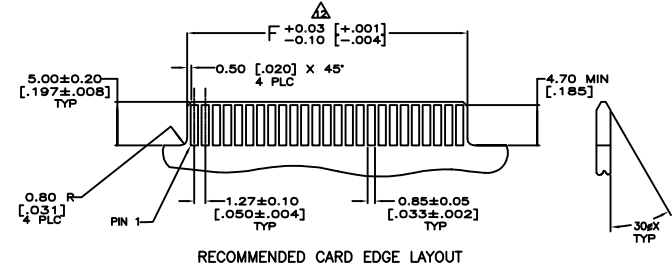
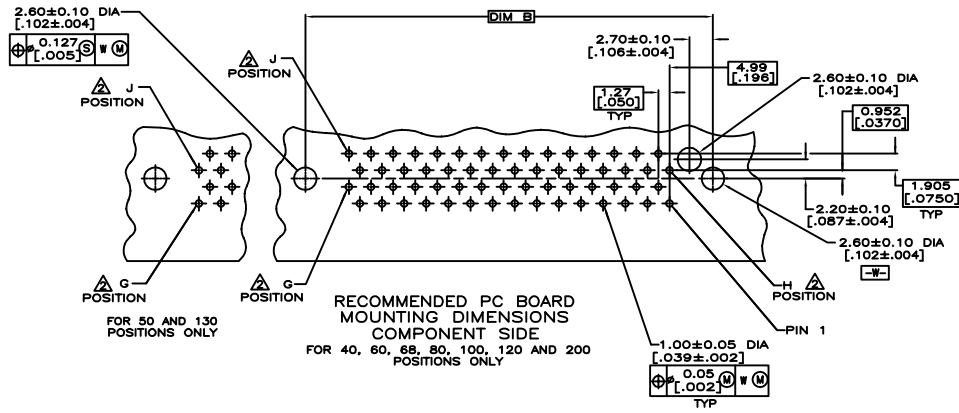

VERTICAL RECEPTACLE ASSEMBLY MATED TO VERTICAL PLUG ASSEMBLY

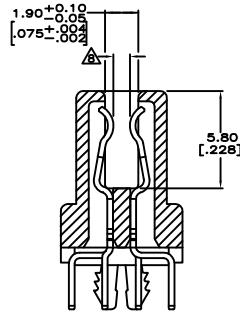

SECTION E-E SCALE 8:1

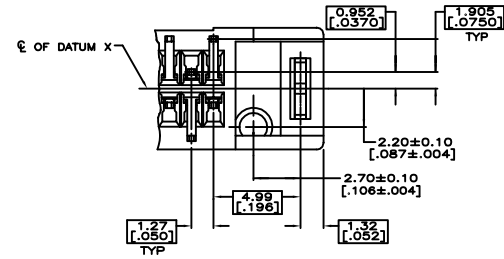

DETAIL D SCALE 8:1

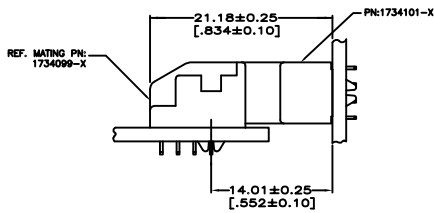

VERTICAL RECEPTACLE ASSEMBLY MATED TO VERTICAL PLUG ASSEMBLY

THIS DRAWING IS A CONTROLLED DOCUMENT.		DWN				
		CHK				
DIMENSIONS: MM		APVD	NAME			
TOLERANCES UNLESS OTHERWISE SPECIFIED: 0 PLC ± - 1 PLC ± - 2 PLC ± - 3 PLC ± - 4 PLC ± - ANGLES ± -		PRODUCT SPEC	RECEPTACLE ASSEMBLY, VERTICAL, BOARD-TO-BOARD, CHAMP.050, SERIES I,			
MATERIAL		QUALIFICATION TEST REPORT	SIZE	CAGE CODE	DRAWING NO	RESTRICTED TO
FINISH		WEIGHT	A3	00779	C=1734101	
CUSTOMER DRAWING			SCALE	SHEET	2 of 4	REV E1

4
 THIS DRAWING IS UNPUBLISHED. RELEASED FOR PUBLICATION AUG. 2006.
 © COPYRIGHT BY TYCO ELECTRONICS CORPORATION. ALL RIGHTS RESERVED.

2 1

LOC	DIST	REVISIONS			
P	LTR	DESCRIPTION	DATE	DWN	APVD
		SEE SHEET 1.			

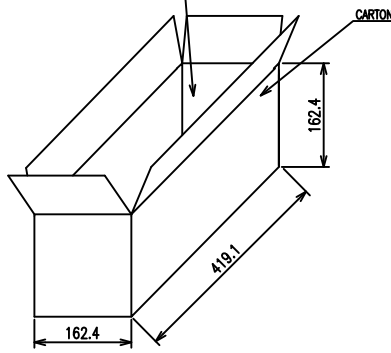
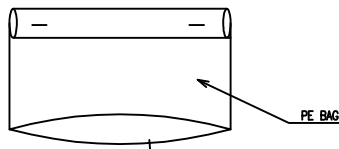
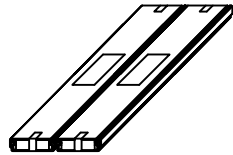
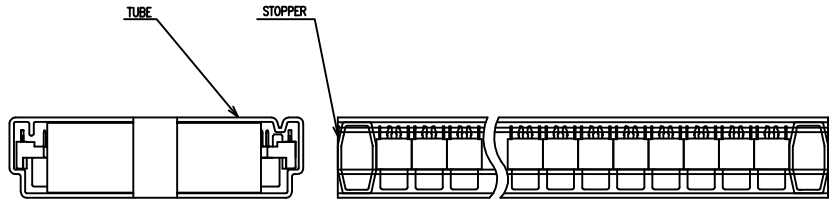

QTY	DESCRIPTION	DATE	DWN	APVD	POS.		
120	5-1734101-3 3-1734101-3 1-1734101-3 5-1734101-2 3-1734101-2 1-1734101-2						
100	6-1734101-1 3-1734101-1 1-1734101-1 5-1734101-0 3-1734101-0 1-1734101-0						
80	5-1734101-8 3-1734101-8 1-1734101-8 4-1734101-8 6-1734101-8 1734101-8						
68	4-1734101-7 6-1734101-7 1734101-7						
60	4-1734101-6 6-1734101-6 1734101-6						
50	2-1734101-7 5-1734101-7 3-1734101-7 1-1734101-7 4-1734101-5 6-1734101-5 1734101-5						
40	4-1734101-4 6-1734101-4 1734101-4						
30	4-1734101-3 6-1734101-3 1734101-3						
	G.W./CARTON (KG)	N.W./CARTON (KG)	PCS/TUBE	TUBES/CARTON	QUANTITY/CARTON (PCS)	PART NUMBER	POS.

THIS DRAWING IS A CONTROLLED DOCUMENT.		DWN		TE Connectivity	
DIMENSIONS: MM		CHK			
TOLERANCES UNLESS OTHERWISE SPECIFIED:		APVD		NAME	
0 PLC ± .1 1 PLC ± .15 2 PLC ± .2 3 PLC ± .3 4 PLC ± .5 ANGLES ± .5		PRODUCT SPEC		RECEPTACLE ASSEMBLY, VERTICAL, BOARD-TO-BOARD, CHAMP.050, SERIES I,	
MATERIAL		QUALIFICATION TEST REPORT		RESTRICTED TO	
FINISH		WEIGHT		SIZE CAGE CODE DRAWING NO	
		CUSTOMER DRAWING		A300779 C=1734101	
		SCALE		SHEET 3 OF 4 REV E1	

4

3

2

1

THIS DRAWING IS UNPUBLISHED. RELEASED FOR PUBLICATION AUG. 2006.
 © COPYRIGHT BY TYCO ELECTRONICS CORPORATION. ALL RIGHTS RESERVED.

LOC	DIST	REVISIONS			
P	LTR	DESCRIPTION	DATE	DWN	APVD
		SEE SHEET 1.			

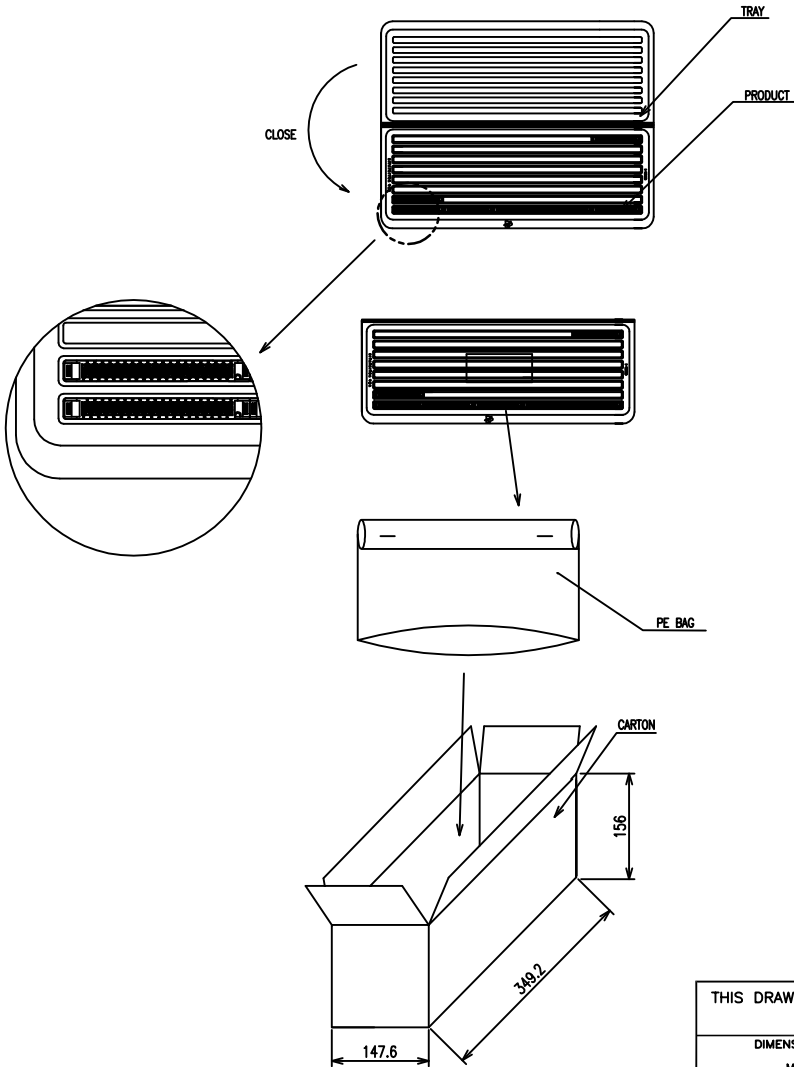

E1	OBSOLETE						5-1734101-6	200
		2.69	1.71	16	10	160	3-1734101-6	
							1-1734101-6	
							5-1734101-5	
							3-1734101-5	
E1	OBSOLETE						1-1734101-6	160
		2.37	1.39	16	10	160	5-1734101-4	
							3-1734101-4	
							1-1734101-4	
							4-1734101-9	
						6-1734101-9	80	
					1734101-9			
		G.W./CARTON (KG)	N.W./CARTON (KG)	PCS/TRAY	TRAYS/CARTON	QUANTITY/CARTON (PCS)	PART NUMBER	POS.

THIS DRAWING IS A CONTROLLED DOCUMENT.		DWN			
DIMENSIONS: MM		CHK			
TOLERANCES UNLESS OTHERWISE SPECIFIED:		APVD		NAME	
0 PLC ± - 1 PLC ± - 2 PLC ± - 3 PLC ± - 4 PLC ± - ANGLES ± -		PRODUCT SPEC		RECEPTACLE ASSEMBLY, VERTICAL, BOARD-TO-BOARD, CHAMP.050, SERIES I,	
MATERIAL		QUALIFICATION TEST REPORT		SIZE CAGE CODE DRAWING NO RESTRICTED TO	
FINISH		WEIGHT		A3 00779 C=1734101	
CUSTOMER DRAWING				SCALE	
				SHEET 4 OF 4 REV E1	

Компания «Life Electronics» занимается поставками электронных компонентов импортного и отечественного производства от производителей и со складов крупных дистрибьюторов Европы, Америки и Азии.

С конца 2013 года компания активно расширяет линейку поставок компонентов по направлению коаксиальный кабель, кварцевые генераторы и конденсаторы (керамические, пленочные, электролитические), за счёт заключения дистрибьюторских договоров

Мы предлагаем:

- Конкурентоспособные цены и скидки постоянным клиентам.
- Специальные условия для постоянных клиентов.
- Подбор аналогов.
- Поставку компонентов в любых объемах, удовлетворяющих вашим потребностям.
- Приемлемые сроки поставки, возможна ускоренная поставка.
- Доставку товара в любую точку России и стран СНГ.
- Комплексную поставку.
- Работу по проектам и поставку образцов.
- Формирование склада под заказчика.
- Сертификаты соответствия на поставляемую продукцию (по желанию клиента).
- Тестирование поставляемой продукции.
- Поставку компонентов, требующих военную и космическую приемку.
- Входной контроль качества.
- Наличие сертификата ISO.

В составе нашей компании организован Конструкторский отдел, призванный помогать разработчикам, и инженерам.

Конструкторский отдел помогает осуществить:

- Регистрацию проекта у производителя компонентов.
- Техническую поддержку проекта.
- Защиту от снятия компонента с производства.
- Оценку стоимости проекта по компонентам.
- Изготовление тестовой платы монтаж и пусконаладочные работы.



Тел: +7 (812) 336 43 04 (многоканальный)

Email: org@lifeelectronics.ru