

PFC MegaPAC-EL™ PFC MegaPAC-HPEL™ Power Factor Corrected AC-DC Switchers



Contents	Page
Overview	1
Standard Features	2
Optional Features	2
Mechanical Considerations	3
MegaPAC Dos and Don'ts	3
Technical Description	4
Configuring and Reconfiguring MegaPACs	5
ConverterPAC Functional Description	7
Part Numbering	8
ConverterPAC Output and Connector Pin Identification	10
PFC MegaPAC-EL and -HPEL Quick Install Instructions	11
PFC MegaPAC-EL and PFC MegaPAC-HPEL Mechanical Drawing	14
Interface Connections	15
Specifications	22
Output Studs	23
Output Power Derating	24
PFC MegaPAC-EL/HPEL Connector Kit (19-130040) Listing	24
Connector Kit for Dual Outputs only - MegaPAC Family 19-130042	24
Current Share Boards - Optional Feature	25
Current Share Boards - Optional Feature Diagram	27
Output Sequencing	28



Overview

The PFC MegaPAC-EL and PFC MegaPAC High Power Low Noise (HPEL) combine power factor correction (PFC) with the configurability of the MegaPAC family of power supplies. The PFC MegaPAC-EL and PFC MegaPAC-HPEL provide up to 1,600W and 2,400W of output power respectively and have power densities of 4.3W/in³ and 6.5W/in³ respectively. The chassis has eight slots and can provide as many as 16 outputs. The PFC MegaPAC-EL and PFC MegaPAC-HPEL have the same input and output connections, mounting points and the same dimensions: 3.4 x 6.0 x 15.6in [85,6 x 152,4 x 396,2mm]. Note that length of older units were 15.5in [393,6mm].

A complete power supply is configured at the factory by selecting and inserting up to eight (four – six for the PFC MegaPAC-HPEL depending on ConverterPACs used) same length slide-in output assemblies called ConverterPACs. ConverterPACs™ incorporate one or two VI-200™ / VI-J00™ and / or Maxi Vicor DC-DC converters and are available in a wide selection of output voltage and power levels. The net result is a power supply that offers the advantages of a custom supply, but is assembled from standard and modular building blocks.

Manufactured at Vicor, the entire family of MegaPAC power supplies is completely user-configurable. If output requirements change, i.e., more power or a different output voltage is needed, upgrading is easy: simply unlock a single screw and replace the slide-in ConverterPAC assembly with one that is of the same length and has the desired voltage power rating. For additional flexibility, ConverterPACs can be connected in parallel to increase output power (booster ConverterPACs), or in series for higher voltages (total output voltage should not exceed 400V). The driver is to the left of the boosters when looking at the output end of the supply. A user-friendly interface provides control and output sequencing capability (see Page 16 for more information about this capability), in addition to useful status indicators. Please consult our Applications Engineering Department if you have other special requirements.

Note: This user guide contains references to parts and products that are no longer available for new designs. They remain included for reference only.

Standard Features

- Power Factor Correction; 0.99 at 115V_{AC}, 0.95 at 230V_{AC}
- Universal Input: 85 – 264V_{AC}, 47 – 500Hz, or 100 – 380V_{DC}
- Power Outputs:
 - PFC MegaPAC-EL™:** 1,600W at 230V_{AC}
1,200W at 115V_{AC}
 - PFC MegaPAC-HPEL™:** 2,400W at 230V_{AC}
1,200W at 115V_{AC}
- Outputs:
 - PFC MegaPAC-EL and HPEL:** Up to 16 outputs
- Output ripple: 10mV_{p-p} or 0.15% whichever is greater
- Fan Cooled
- Full-power to 40°C; half power to 60°C
- Soft start for limiting inrush current
- Conducted EMI meets FCC Class A and EN55022 A specifications (some configurations meet Class B. Contact factory)
- Harmonic Distortion to EN61000-3-2
- RoHS compliant available
- Output Sequencing and General Shutdown (General Shutdown refer to Page 17. Output sequencing refer to Page 28. Consult Applications Engineering for automatic sequencing circuitry.)
- Overcurrent protection on all outputs
- Overvoltage protection on all ConverterPAC outputs (not applicable with VI-J00 modules)
- Overtemperature limiting on all ConverterPAC outputs (not applicable with VI-J00 modules)
- Size: 3.4 x 6.0 x 15.6in [85,6 x 152,4 x 396,2mm]
- Safety Agency Approvals: CE Mark, cTÜVus, UL

Optional Features

- DC OK status signal
- Current Share Boards - see Pages 25 – 27
- Output voltage adjustment range with built-in potentiometer

Mechanical Considerations

The PFC MegaPAC-EL™ and PFC MegaPAC-HPEL™ can be mounted on any of four surfaces using standard 8-32 or 4mm screws. The chassis comes with four mounting points on each surface; maximum allowable torque is 20lb-in. The maximum penetration is 0.15in [3.8 mm].

When selecting a mounting location and orientation, the unit should be positioned so air flow is not restricted. Maintain a 2in minimum clearance at both ends of the PFC MegaPAC-EL and PFC MegaPAC-HPEL and route all cables so airflow is not obstructed. The standard unit draws air in at the fan side / AC input side and exhausts air out the load side. If airflow ducting is used, use caution, as sharp turns could present back pressure to the PFC MegaPAC-EL and PFC MegaPAC-HPEL. The fan moves approximately 30CFM of air.

Avoid excessive bending of output power cables after they are connected to the PFC MegaPAC-EL and PFC MegaPAC-HPEL. For high-current outputs, use cable ties to support heavy cables in order to minimize mechanical stress on output studs. Be careful not to short-out to neighboring output studs. The PFC MegaPAC-EL and PFC MegaPAC-HPEL units are supplied with serrated, flanged hex-nuts on all output studs. Therefore, thread-locking compounds or lock washers are not required. The maximum torque recommended on flanged nuts is 45lb-in. Never loosen the inner nut on a ConverterPAC™. This nut supports the hardware inside the ConverterPAC and is factory torqued.

Avoid applications in which the unit is exposed to excessive shock or vibration levels. In such applications, a shock-absorption mounting design is required.

MegaPAC™ Dos and Don'ts

- For units without Autosense, do not leave ConverterPAC Sense lines open. Always terminate them to their respective output locally or at the load. Use twisted pair 22-24AWG wire. If ConverterPAC has Autosense, no local-sense connection is required. See Pages 11 and 12 for more information on Autosense.
- If needed, use Connector Kit # 19-130040 for the PFC MegaPAC-EL and PFC MegaPAC-HPEL.
- Always fill all output slots of the MegaPAC. If a slot is not filled with a ConverterPAC, it should be filled with an airblock. Airblocks are plastic assemblies whose main function is to fill up an empty slot. Any airflow escape from an empty slot significantly degrades thermal performance and can result in overheating and damage to the power supply.
- Always turn the power supply off before disconnecting input or output wires.
- NEVER disconnect the +Out and –Out load wires while the supply is operating, as disconnecting WILL cause damage to the power supply.
- Do not unplug ConverterPACs while input power is applied. They are not designed for hot-plug applications.
- Do not restrict airflow to the unit. The cooling fan draws air into the unit and forces it out at the output power terminals.

-
- For power expansion, use booster ConverterPACs™. Viewing the unit from the output terminal side, always insert boosters to the right side of the driver.
 - Do not use boosters as independent outputs. Disconnecting bus bars will damage booster ConverterPACs.
 - For booster arrays, do not remove bus bars.
 - Always ensure that output hex-nuts are properly torqued before applying power to supply.
 - Run the output (+/-) power cables next to each other to minimize inductance.
 - Wait five minutes after shutting off power before inserting or removing ConverterPACs.
 - The MegaPACs does not have user serviceable components. They must be returned to the factory for repairs. Contact Customer Service for a RMA number before returning the unit. Do not attempt to repair or modify the power supply in any manner other than the exchange of ConverterPACs as described in this Design Guide.
 - Insert proper fault protection at power supply input terminals (i.e., a fuse).
 - Use proper size wires to avoid overheating and excessive voltage drop.
 - Never loosen the inner nut on a ConverterPAC.
 - Verify output nuts are tight before powering up.
 - FinQPACs™ require two slots each because of the larger heat sink attached to dissipate the extra heat generated by the higher-power Maxi module. Refer to Page 8 for more information on which ConverterPACs can be used.

Technical Description

The PFC MegaPAC-EL™ and PFC MegaPAC-HPEL™ chassis consists of an offline single phase, power-factor-corrected front end, EMI filter, cooling fan, low-noise filters, customer interface and associated housekeeping circuits. Input AC mains voltage (L1, L2 and GND) is applied to a terminal block. The input current is passed through an EMI filter designed to meet conducted noise limit A specifications of FCC Part 15, VDE 0871 and EN55022 Class A. At start up, inrush current is limited by a PTC thermistor. The PTC is shunted out shortly after initial power up by a DC bus voltage Sense circuit driving a relay. After rectification, the input voltage is put through a boost converter that keeps the AC input current sinusoidal and synchronized with the AC input voltage (in compliance with EN61000). The boost converter delivers regulated high voltage DC to the hold-up capacitors and backplane. The backplane supplies power to a variety of ConverterPAC assemblies that provide the desired regulated outputs.

Voltage conversion in the output assemblies is achieved by the Vicor family of Zero-Current Switching (ZCS) DC-DC converters. These are forward converters in which the main switching element switches at zero current. This patented topology has a number of unique attributes: low-switching losses; high-frequency operation resulting in reduced size for magnetics and capacitors; excellent line- and load- regulation; wide-adjustment range for output; low EMI / RFI emissions and high efficiencies.

At initial power up, the PFC MegaPAC-EL and PFC MegaPAC-HPEL outputs are disabled to limit the inrush current and to allow the DC bus potential to settle out to the correct operating level. A low-power flyback converter operating with PWM current-mode control converts the high-voltage DC bus into regulated low voltage to power the internal housekeeping circuits and DC cooling fan. The internal housekeeping V_{CC} comes up within two seconds after the application of input power. Once the high-voltage bus is within its limits, the AC OK signal asserts to a TTL "1" indicating the input power is OK and enables the power outputs. An auxiliary V_{CC} output of $5V_{DC}$ sourcing up to 0.3A is provided for peripheral use.

An output Enable / Disable function is provided by using an optocoupler to control the Gate In pins of the ConverterPAC™ assemblies. If the Enable / Disable control pin is pulled low, the optocoupler turns on, pulling the Gate In pin low and disabling the ConverterPAC output. The nominal delay for an output to come up when measured from release of the Enable / Disable pin is 10 – 15ms. The General Shutdown function controls all outputs simultaneously and works in a similar manner.

The ride-through (hold-up) time is the amount of time the load can be supported before loss of output regulation after the loss of input power. Detecting the loss of input power takes a finite time period after which the AC Power OK signal goes from a TTL "1" to "0." This signal is available for use within 1.2s after initial power up and can be used to indicate an impending loss of power. At least 3ms of warning time is given. Following the loss of input power, the outputs are disabled when the bus voltage drops below its operating threshold.

Figure 1
PFC MegaPAC-EL™ and
PFC MegaPAC-HPEL™
low-noise architecture

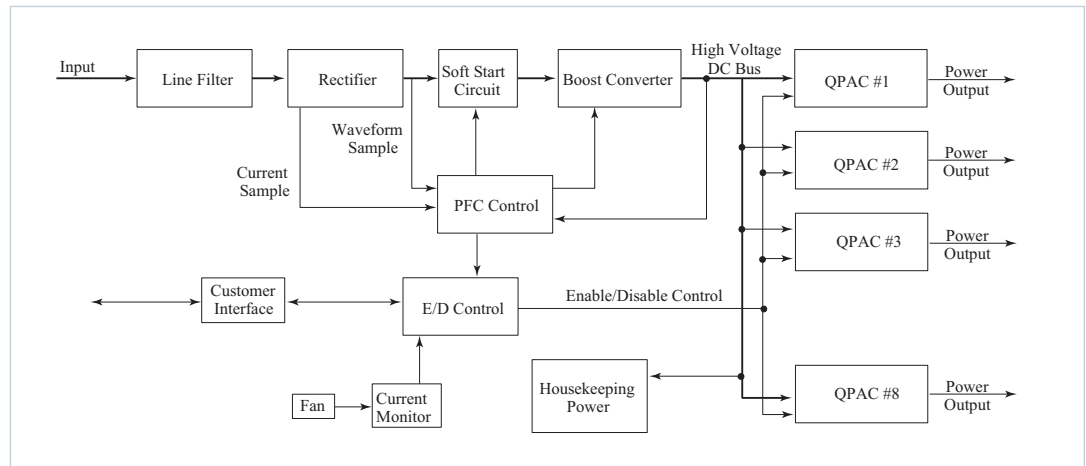

Configuring and Reconfiguring MegaPACs

Most ConverterPACs of the same length can be inserted into any available slot of a MegaPAC chassis. They can also be easily added, replaced or moved by sliding the assemblies in or out of a MegaPAC chassis. For outputs greater than 200W, a driver QPAC™ and one or more booster ConverterPACs will be used. For outputs greater than 600W, a driver FinQPAC™ and one or more booster ConverterPACs will be used. Arrays of drivers and boosters should be configured so all boosters are placed in the slots to the immediate right of the driver when looking at the output end of the MegaPAC.

Prior to removing or installing ConverterPACs, you must remove power from the MegaPAC and wait five minutes. Failure to do so can result in personal injury or damage to the supply.

Take standard ESD precautions when handling ConverterPACs.

Removing ConverterPACs

ConverterPACs can be removed by loosening the captive screw at the base. Once this screw has been loosened, the ConverterPAC will slide out of the chassis. **Once a ConverterPAC has been removed, the empty slot MUST be filled with either another ConverterPAC or an airblock.** If the slot is left empty, it will provide an airflow escape and cause failure to the power supply.

Installing ConverterPACs as Drivers

ConverterPACs™ can be installed in empty slots by simply sliding in the new ConverterPAC and securing the screw at the base. Torque the retaining screw to 0.23N·m (2lb·in); do not overtighten. Power and interface connections can be made after the ConverterPAC has been installed.

Installing Booster ConverterPACs to Increase Output Power

ConverterPACs can be paralleled for more power. Additional power to an output is obtained by connecting one or more boosters in parallel with a single driver. The driver can be placed in any open slot. All boosters should be inserted in the slots to the immediate right of the driver as viewed from the output end of the MegaPAC™. Figure 2 shows a driver placed in slots #1 and 3, boosters placed in slots #2 – 4. After inserting the driver and boosters, they are paralleled using bus bars across the positive- and negative-output studs. Drivers should not be paralleled with each other. Bus bars between a driver and booster(s) should never be disconnected. For help in identifying boosters and drivers, refer to the Part Numbering section on Page 8. Please note that total output voltage should not exceed the converter baseplate-output isolation rating of 400V. For a detailed guideline on how outputs should be placed in series, please refer to: [AN:204 Creating High-Voltage Outputs](#).

Figure 2
Paralleling ConverterPACs



ConverterPAC Functional Description

ConverterPACs™ are the family of slide-in output assemblies used in MegaPAC™ power supplies. Most ConverterPACs of the same length are interchangeable within a MegaPAC or between different AC input MegaPAC chassis. They can be added, moved or changed as necessary. **A key feature of the Extended Length ConverterPAC is the low ripple and noise output to 10mV_{p-p} or 0.15%, whichever is greater.** The following Extended-Length ConverterPACs can be used in the PFC MegaPAC/EL - Low Noise.

QPAC™ (L)

The QPAC output assembly consists of a VI-200™ DC-DC converter that converts the unregulated high-voltage bus to the desired regulated output voltage. Each QPAC (L) can provide up to 200W of output power, and booster QPACs can be added in parallel for more power. Power and slave QPACs can be added in parallel for more power. QPACs are fused with a PC-Tron, DC-rated, fast-acting fuse. An active preload ensures the DC-DC converter operates in its highest-noise performance range. As the load on the module increases, the preload removes itself from the circuit. QPACs, using the VI-200 module, have an optional DC OK TTL signal. All QPACs have overcurrent protection with automatic recovery when the overcurrent condition is removed. Overvoltage Protection (OVP) and Overtemperature Limiting (OTL) are available. **Please note that for the QPAC (L), the output voltage from either output terminal to chassis should not exceed 400V_{DC}, or peak.**



QPAC

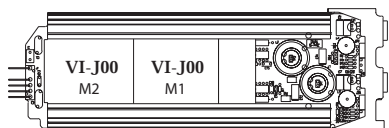

DualPAC

DualQPAC™ (LD)

The DualQPAC output assembly consists of two VI-J00 DC-DC converters that provide two isolated output voltages. DualQPACs can provide up to 100W of output power from each output. The DualQPACs are fused with a PC-Tron, DC-rated, fast-acting fuse. An active preload ensures the DC-DC converter operates in its highest noise performance range. OVP and OTL is not available. **Please note that for the QPAC (L) the output voltage from either output terminal to chassis should not exceed 400V_{DC}, or peak.** For detailed pinout description, refer to Page 10.

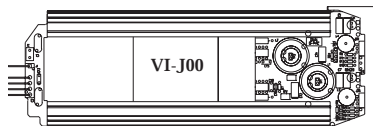

JuniorQPAC

JuniorQPAC™ (LJ)

The JuniorQPAC output assembly consists of a VI-J00 Vicor DC-DC converter that converts the unregulated high-voltage bus to the desired regulated output voltage. OVP and OTL is not available. **Please note that for the QPAC (L) the output voltage from either output terminal to chassis should not exceed 400V_{DC}, or peak.**

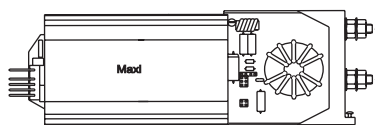

FinQPAC

FinQPAC™ (PZL)

The FinQPAC output assembly consists of a Maxi DC-DC converter that converts the unregulated high-voltage bus to the desired regulated output voltage. Each Maxi module can provide up to 600W of output power. Each FinQPAC occupies two slots because it has an extra large heat sink attached to dissipate the heat generated by this more powerful Maxi converter. It cannot be used in any other member of the MegaPAC Family. FinQPACs have overcurrent protection with automatic recovery when the overcurrent condition is removed. Overvoltage Protection (OVP) and Overtemperature Limiting (OTL) are available. **Please note that for the FinQPAC (PZL) the output voltage from either output terminal to chassis should not exceed 400V_{DC}, or peak.**

List of ConverterPACs™ used in the PFC MegaPAC-EL™ and PFC MegaPAC-HPEL™ Low Noise and their features

ConverterPAC	OVP	OCP	OTL	RS/AS*	LS/AS*	PG	TrimPot
QPAC (L)	Std	Std	Std	AS ^[a]	AS ^[a]	Opt	Opt
DualQPAC (LD)	N/A	Std	N/A	AS ^[a]	AS ^[a]	Opt	N/A
JuniorQPAC(LJ)	N/A	Std	N/A	AS ^[a]	AS ^[a]	Opt	Opt
FinQPAC(PZL)+	Std	Std	Std	AS ^[a]	AS ^[a]	Opt	Opt

OVP	Overvoltage Protection (latching)	RS	Remote Sense
OCP	Overcurrent Protection (auto-recovery)	LS	Local Sense
OTL	Overtemperature Limiting	AS	Autosense
PG	Power Good (DC OK TTL Signal)		+ Maxi OTL is non-latching

^[a] See Pages 11 and 12 for more information on Autosense.

Note: All ConverterPACs mentioned above can be paralleled EXCEPT the DualQPAC and JuniorQPAC.

Part Numbering

PFC MegaPAC-EL **MP_{x_A}-7_{x_B}_{xxxx}-_{x_C}-_{x_D}**
 eg. MP5-782560-G-EL

PFC MegaPAC-HPEL **MX_{x_A}-7_{x_B}_{xxxx}-_{x_C}-_{x_D}**
 eg. MX4-742543-2-EL

- MP** = MegaPAC™ prefix
- x_A** = number of outputs
- 7** = power factor corrected
- x_C** = optional code ex. G = RoHS
- MX** = PFC MegaPAC-HPEL prefix
- X** = PFC chassis that can use Maxi
- x_B** = Number of modules
- xxxx** = assigned by Vicor
- x_D** = optional code e.g., **EL** = Extended Length

ConverterPAC **X_{x_D}V/x_EA_{x_F}**
 eg. L15V/10A

- X** = ConverterPAC type (For RoHS, add G to current prefix)
- x_D** = Voltage out
- x_E** = Current out (rounded to one decimal point)
- x_F** = Can be multiple options (see Page 9)

ConverterPAC™ options

B	Booster module	M	Military Grade module
D	DC OK or Power Good ^[b]	R	RAM external ^[d]
F	Full 50 – 110% output adjustment ^[c]	S	Trimpot removed for external BatPAC™ adjustment
F1	50 – 107.5% output adjustment	T	90 – 110% output adjustment ^[e]
F2	50 – 105% output adjustment	T1	90 – 107.5% output adjustment
F3	50 – 102.5% output adjustment	T2	90 – 105% output adjustment
F4	50 – 100% output adjustment	T3	90 – 102.5% output adjustment
F5	60 – 110% output adjustment	T4	90 – 100% output adjustment
F6	70 – 110% output adjustment	T5	98 – 105% output adjustment
F7	80 – 110% output adjustment	T6	100 – 110% output adjustment
F8	90 – 110% output adjustment	V1	"VXI" low noise (150mV) $15V < V_{OUT} \leq 24V$ outputs ^[e]
F9	100 – 110% output adjustment	V2	"VXI" low noise (50mV) $V_{OUT} \leq 15V_{DC}$
I	Industrial Grade module	V3	"VXI" low noise (1% ripple) $V_{OUT} > 24V$
K	Custom SRF module used		
P	Preload		

^[b] **D option:** Optional for all ConverterPACs used in this power supply.

^[c] **T & F options:** Optional for all ConverterPACs used in this power supply EXCEPT the DualQPAC™.

^[d] **R option:** N/A to any ConverterPACs used in the PFC MegaPAC-EL™ / PFC MegaPAC-HPEL™.

^[e] **V options:** N/A to any ConverterPACs used in the PFC MegaPAC-EL / PFC MegaPAC-HPEL.

ConverterPAC™ Output and Connector Pin Identification

QPAC™ JuniorQPAC™



DualQPAC™



DUALQPAC - COMPONENT SIDE VIEW



Example: LD12V/8.3A-48V/2.1A

FinQPAC™



Notes:

1. All ConverterPACs except the FinPAC™ occupy one slot. The FinPAC occupies two slots.
2. New output studs were installed on the ConverterPACs and are 1/8th inch longer. Refer to Pages 14 and 23 for more information.

PFC MegaPAC-EL™ and -HPEL Quick Install Instructions

(For Mechanical Drawing, see Page 14)

Mounting the PFC MegaPAC-EL and PFC MegaPAC-HPEL™

- Mount the power supply on any of its four sides.
- Use #8-32 or 4mm mounting screws. Do not exceed a maximum penetration of 0.15in [3,8 mm]. The maximum allowable torque is 20lb-in.
- Maintain 2in [5,1cm] clearance at either end for airflow.

Input Connections

Input Power J9

- Apply input AC power to terminal block J9 using a pressure screw terminal.
- Strip length of AC power conductors to be 0.35in.
- Maximum torque is 4.4lb-in.
- Place a fuse or circuit breaker in the input line for safety reasons.
- Use a maximum wire size of 14AWG with soldered terminals.
- The connector manufacturer recommends the wires not be tinned. A ferrule (Phoenix P/N 32-00-58-0, purchased from other sources) can be used to prevent fraying.

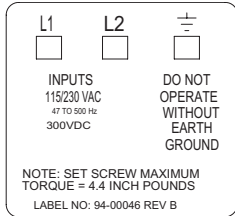

INPUT CONNECTIONS
 J9-1 EARTH GROUND
 J9-2 L2-NEUTRAL
 J9-3 L1

Input Panel Connectors



Single Output QPAC™

Output Connections

Power Connections

Installing ring lugs and / or bus bars on output studs:

- The upper stud is Positive and the lower stud is the Return.
- Newer outputs studs are 1/8th inch longer. See Pages 14 and 23 for more information.
- Remove nut.
- Place ring lug over output stud.
- Replace and tighten outer nut to a maximum torque of 45lb-in. **Do Not Over-Tighten Nuts.**
- Verify all output nuts are properly installed before turning on supply.

DualQPAC™ Output Connector

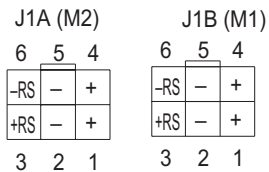

Installing power connectors on DualQPACs - J1A (M2) and J1B (M1):

- Use Molex mating receptacle #39-01-2060 with #39-00-0039 terminals provided.
- Pins 1 and 4 are Positive, while pins 2 and 5 are the Return.
- Attach terminals to 18-24AWG stranded wire using Molex tool #11-01-0197.

Sense Connections

Newer power supplies have the Autosense feature. For these units, if Remote Sense connections are not made or needed, no Local Sense selection is necessary - simply connect the output to the load and the unit will automatically operate in Local Sense. If Remote Sense connections are made, the unit will operate in a Remote Sense mode. Remote Sense terminals should be terminated to their respective output i.e., -RS to -Output and +RS to +Output. See Page 12 for more information on Autosense. **For units without Autosense, sense connections must ALWAYS be made. Not connecting sense lines to their respective output can cause failure to the unit. WARNING: NEVER disconnect the +Out and -Out load wires while the supply is operating as disconnecting WILL cause damage to the power supply.**

7	TRIM TOP
6	TRIM BOT
5	N/C
4	VCC IN
3	POWER GOOD
2	POWER GOOD INVERTED
1	SIGNAL GROUND

J2/P2 Sense Connectors

Sense Connector J2 (and P2 for the FinQPAC™):

- Sense connections do not have to be made if either the Local Sense option was ordered (older units) or if Autosense is present (see previous note on Autosense).
- Attach opposite ends of Sense lines to point where regulation is desired.
- Verify that Sense lines are not cross-connected before applying input power.
- For the QPAC™, J2-7 is the +Sense and J2-6 is the –Sense.
- For the FinQPAC, P2-7 is the +Sense and P2-6 is the –Sense.
- Use Molex mating receptacle #39-01-0073 with #39-00-0031 terminals provided.
- Attach terminals to 22-28AWG stranded wire using Molex tool #57005-5000.

Sense Connections on DualQPACs™:

- Sense connections do not have to be made either if the Local Sense option has been ordered or Autosense is present (refer to note on Autosense).
- Sense connections are available on the J2 connector (P2 for the FinQPAC) or the J1A (M2) and J1B (M1) connectors.
- If using J2 or P2 connector, see pin description on Page 10.
- On J1A and J1B, Pin 3 is the +Sense and Pin 6 is the –Sense.
- Use Molex mating receptacle #39-01-2060 with #39-00-0039 terminals provided.
- Attach terminals to 18-24AWG twisted pair wire using Molex tool #11-01-0197.
- Verify that Sense lines are not cross connected before applying input power.

J1-B (M1)		
4	1	1 AND 4 +VOUT
5	2	2 AND 5 –VOUT
6	3	3 +R/SENSE 6 –R/SENSE

J1-A (M2)		
4	1	1 AND 4 +VOUT
5	2	2 AND 5 –VOUT
6	3	3 +R/SENSE 6 –R/SENSE

DualQPAC Sense Connector

7	TRIM TOP
6	TRIM BOT
5	N/C
4	VCC IN
3	POWER GOOD
2	POWER GOOD INVERTED
1	SIGNAL GROUND

Trim Pin Connection on the J2 /P2 Connector

Trim Pin Connection J2 for QPACs (and P2 for FinQPAC)

- The Trim J2 connection should only be made if the Trim option has not been installed. (A “T” or an “F” in the ConverterPAC™ part number means the Trim option is installed; eg. M5V/40AT).
- For the QPAC™, refer to J2 Connector. J2-5 provides Trim Access.
- For the FinQPAC, refer to P2 Connector. P2-5 provides Trim Access.
- Use Molex mating receptacle #39-01-0073 with #39-00-0031 terminals provided.
- Attach terminals to 22-28AWG stranded wire using Molex tool #57005-5000.

Trim Pin Connection J2 for DualQPACs

- The Trim J2 connection should only be made if the Trim option has not been installed.
- J2-7 is Trim B and J2-6 is Trim A.
- Use Molex mating receptacle #39-01-0073 and #39-00-0031 terminals provided.
- Attach terminals to 22-28AWG twisted pair wire using Molex tool #57005-5000.

J2-PIN1

7	TRIM TOP B
6	TRIM BOT A
5	N/C
4	VCC IN
3	POWER GOOD
2	POWER GOOD INVERTED
1	SIGNAL GROUND

7	+SENSE
6	-SENSE
5	TRIM
4	VCC IN
3	POWER GOOD
2	POWER GOOD INVERTED
1	SIGNAL GROUND

**DC OK/Power Good
Connection on
the J2 /P2 Connector**
J10

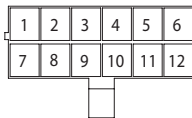

J10 INTERFACE

J10-1	E/D-1	J10-7	E/D-7
J10-2	E/D-2	J10-8	E/D-8
J10-3	E/D-3	J10-9	VCC +5V, 0.3A
J10-4	E/D-4	J10-10	SIGNAL GROUND
J10-5	E/D-5	J10-11	AC POWER OK

Interface Connections J10

DC OK (Power Good) Connection J2 (and P2 for FinQPAC™)

- DC OK is only available as an option and is not present unless requested.
- For the QPAC™, refer to the J2 connector. J2-3 is Power Good.
- For the FinQPAC, refer to the P2 connector. P2-3 is Power Good.
- Use Molex mating receptacle #39-01-0073 with #39-00-0031 terminals provided.
- Attach terminals to 22-28AWG stranded wire using Molex tool #57005-5000.

Interface Connections J10

- Use Molex mating receptacle #39-01-2120 with #39-00-0039 terminals.
- J10-1 through 8 are Enable / Disable for slots 1 – 8.
- J10-9 is VCC, J10-10 is Signal Ground, J10-11 is AC Power OK and J10-12 is General Shutdown.
- Attach terminals to 18-24AWG stranded wire using Molex tool #11-01-0122.

Interface Connections

Chassis Input Power Terminals (J9)

Input AC power is applied to terminal block J9 using a pressure screw terminal that accepts a maximum wire size of 14AWG. The insulation should be stripped 0.35in and the maximum torque applied to the screws should not exceed 4.4lb-in.

The connector manufacturer recommends the wires not be tinned. A ferrule (Phoenix P/N 32-00-58-0, purchased from other sources) can be used to prevent fraying. J9-1 (GND) is Earth Ground for safety; J9-2 (L2) and J9-3 (L1) are the other Hot connections. For Input DC power, L2 is (+) and L1 is (-).

A fault clearing device, such as a fuse or circuit breaker with a maximum 15A rating at the power supply input is required for safety agency compliance. It should be sized to handle the start-up inrush current of $25A_{PK}$ at $115V_{RMS}$ and $230V_{RMS}$.

Figure 3
Input panel connectors



Output Power Connections (+P, -P for Single Output, or J1A/J1B for Dual Outputs)

For single output ConverterPACs, these terminals are two 1/4-20 plated steel studs. The upper stud is positive with respect to the lower stud. For dual output ConverterPACs, there is a six-pin Molex connector for each output. J1A (M2) pins 1 and 4 are the +Output, and J1A pins 2 and 5 are the -Output. Pins 3 and 6 are duplicates of the Remote Sense terminals present on J2A and J2B. Use appropriate wire size rated to handle the full output current, including short-circuit levels. Avoid large current loops in output cables; run power and return cables next to one another to minimize inductive effects. All outputs are isolated and can provide positive or negative outputs.

Output +/-Sense Connections -J2 for Single Output, or J1A/J1B for Dual Outputs

Newer power supplies may have some outputs configured with the Autosense feature that automatically locally senses the output if remote sense is not used. To check if an output has the Autosense feature, measure the impedance from the + Out to +Sense and -Out to -Sense pins. If the impedance is 5Ω , then the output has Autosense and does not require local-sense jumpers.

If units do not have Autosense, sense connections must be made. When making sense connections, keep in mind that although all outputs are open-Sense protected, the +/-Sense terminals MUST be connected to their respective outputs before the PFC MegaPAC-EL™ and PFC MegaPAC-HPEL™ are powered up. (NEVER disconnect the +Out and -Out load wires while the supply is operating as disconnecting WILL cause damage to the power supply). Regardless of the output polarity configured, the +Sense should always connect to the +Power output. The -Sense connects to the -Power output. Sense connections are not required on booster ConverterPACs™ or if the Local Sense option is specified (old units). Local Sense mode means that the Remote Sense lines are not connected. Sense pins can be accessed on J1A/J1B or J2A/J2B on dual output units.

Signal Ground (J10-10)

Signal Ground (see Figure 4 and Connector Pin Identification) is an isolated ground reference for all J10 interfacing signals and can be used for ConverterPAC™ output status signals such as Power Good. This is not the same as Earth Ground on input power connector J9.

Figure 4
Interface connector



Enable/Disable (J10-1 to J10-8)

The Enable / Disable control pins allow ConverterPAC outputs to be set either on or off. J10-1 through J10-8 are the control pins for output positions 1 – 8, respectively (see Figure 5 and Connector Pin Identification above). For DualQPACs™, both outputs are set on or off by the same control pin. In parallel arrays, only the driver ConverterPAC need be controlled. The Enable / Disable pins must be pulled low to less than 0.7V with respect to Signal Ground to disable the outputs. They will sink 10mA maximum. These pins should be open circuited or allowed to exceed 4.5V when enabled. Do not apply more than 6V to these inputs at any time. If driven from an electromechanical switch or relay, a capacitor should be connected to eliminate the effects of switch bounce.

Figure 5
Enable / disable and
general shutdown



Enable / Disable control of Maxi Module Arrays

When using the Enable / Disable function on an output that consists of two or more Maxi modules, it is necessary to connect the E/D pins of the corresponding module locations together such that both modules are commanded to turn ON or OFF simultaneously.

Example:

Slots 2, 4 and 6 have been configured as a single-output parallel array (see Figure 6).

In order to disable the 48V output, E/D 2, E/D 4 and E/D 6 should be shorted together as shown in Figure 6. With E/Ds connected together, a single switch can then be used to remotely enable and disable the output.

Note: For single output power supply configurations, the simplest method of remotely enabling and disabling the output is to use the General Shutdown (GSD) function.

Figure 6
Enable / disable control
of Maxi Arrays



General Shutdown / GSD (J10-12)

The GSD control pin on J10-12 allows simultaneous shutdown of all ConverterPAC™ outputs (see Connector Pin Identification on Page 16, Figure 4). This pin must be pulled down to less than 0.7V and will sink 13mA maximum to shut down all outputs. The GSD pin should be open circuited or allowed to exceed 4.5V when not in use or when the outputs are to be enabled. Do not apply more than 6V to this input at any time. Normal open circuit voltage is 1.5 – 3V with respect to Signal Ground. If driven from an electromechanical switch or relay, a capacitor should be connected to eliminate the effects of switch bounce.

AC OK / Power Fail (J10-11)

This is an active high TTL compatible signal and provides a status indication of the AC input power (see Figure 7 and Connector Pin Identification on Page 16, Figure 4). It is capable of sourcing 0.5mA at >3.2V and sink 16mA at <0.5V. This signal switches to a TTL "1" when the high-voltage bus exceeds low-line condition during turn-on and switches to a TTL "0" 3ms (minimum) before loss of output regulation due to the loss of input AC power. This signal can be used to warn external control circuits of an impending loss of power.

Figure 7
AC OK Power Fail



Auxiliary VCC +5V / 0.3A (J10-9)

The VCC on J10-9 is an auxiliary 5V regulated power source (see Figure 8 and Connector Pin Identification on Page 16). It is $+5V_{DC} \pm 5\%$ with respect to Signal Ground and can supply 300mA maximum. It is short-circuit-proof, but if shorted all outputs will shut down through the Enable / Disable circuitry. The Auxiliary VCC typically powers user circuitry or is used with the Power Good circuitry to provide a pull-up reference for the outputs of the DC Power Good circuit on a ConverterPAC™. If used for this purpose, the Signal Ground on J10-10 must also be connected to the J3-1 Signal Ground pin of the ConverterPAC.

Figure 8
Auxiliary VCC



Power Good (J2-3 / P2-3)

The optional Power Good signal on J2-3 / P2-3 is referenced to Signal Ground on J2-1 / P2-1 and indicates the status of the output voltage. This signal is asserted a TTL "1" when the output voltage is above 95% of nominal. It is a TTL "0" when the output voltage is below 85% of nominal. If the Trim option is also used, the Power Good trip points DO NOT track with the trimmed voltage. It is possible to trim the output below the fixed set points of the Power Good circuit and cause a negative Power Good signal.

Figure 9
Power Good and VCC



Power Good Inverted (J2-2 / P2-2)

This is the inverse of the Power Good signal and is referenced to Signal Ground on J2-1 / P2-1.

Signal Ground (J1-1 / P2-1)

Signal Ground on J2-1/P2-1 is an isolated secondary ground reference for J2/P2 status signals. It is used to provide a reference point for the Power Good circuitry and is not the same as Earth Ground on input power connector J9.

VCC IN (J2-4 / P2-4)

The VCC IN on J2-4/P2-4 is an input that requires +5V either from the J10 Auxiliary VCC, or from another source. Input current to this pin is limited by an internal resistor to 3mA. If the J10 Auxiliary VCC is connected to VCC IN on J2-4/P2-4, then the J10 Signal Ground must be connected to Signal Ground on J2-1/P2-1.

+Sense / -Sense - J2-6 and J2-7 (See Pages 11 and 12 for information on Autosense)

The +Sense on J2-7 should be connected to the +Power Out, and the -Sense on J2-7 to the -Power Out terminal. Do not reverse or leave the Sense pins open. Sense pins can be terminated locally at the output of the power supply, in which case the power supply will provide regulation at the output terminals. The voltage appearing at the load may drop slightly due to voltage drop in the power cables. If it is necessary to compensate for voltage drop along the output power cables, this termination should be made close to the output load. Compensation of up to 0.5V (0.25V per lead) can be obtained. Use twisted pair 22-24AWG wire for this purpose.

For DualQPACs™, the +Sense pins are available on connectors designated as J2A-2 and J2B-2 for outputs A and B, respectively. -Sense pins are on J1A-3 and J1B-3, respectively. These pins are also duplicated on the power connectors J1A and J1B.

Reminder: Only units with Autosense will automatically operate in Local Sense mode if no Sense connections are made. It will operate in Remote Sense mode if Remote Sense connections are made. Units without Autosense MUST have sense connections (Local or Remote) terminated to their respective output for the unit to operate properly. Further, NEVER disconnect the +Out and -Out load wires while the supply is operating as disconnecting WILL cause damage to the power supply.

Figure 10
Sense Leads



External Trim (J2-5/P2-5)

Output voltage can be trimmed using an optional factory-installed Trim potentiometer or with the Trim pin (see Figure 11). The Trim potentiometer is located on the ConverterPAC™. If the Trim potentiometer has not been ordered, the Trim pin must be used. When using the Trim pin, the Trim limits are determined by the DC-DC converter used on the ConverterPAC. Maximum Trim ranges are 10% above the nominal converter voltage and 50% below the nominal converter voltage (except 10, 12 and 15V outputs which are 10% below nominal) as measured from the output studs or output connector of the power supply.

Note: The combined effects of module trim up, remote sense and dynamic-load step may cause the module to trip OVP. (Tripping OVP will require cycling input power to the supply off, then on).

The Trim pin on J2/P2 can be used to control the output voltage. It is referenced to the –Sense pin on J2 and can be controlled by either a resistor network or an external voltage source. To increase an output voltage above its nominal, it is necessary to increase the voltage at the Trim pin above the internal reference voltage (V_{REF}). The reverse is true to decrease an output voltage.

Note: Converters are sometimes pretrimmed at the factory if a nonstandard output voltage is requested. If using a nonstandard voltage or if a ConverterPAC is ordered with a Trim option, the resistor calculations will differ from those on Page 21. Please consult the factory for assistance.

Table 1
Module internal
reference voltages and
Thevenin resistances

Output Module	V_{REF}	R_{TH}
VI-200™ / VI-J00™ $\geq 3.3V$	2.50V	10.0kW
VI-200 / VI-J00 $< 3.3V$	0.97V	3.88kW
Maxi (Pre-Defined)	1.23V	1.0kW
Maxi (User-Defined)	1.23V	Consult Factory

Figure 11
External trim



Example:

±10% Trim adjust on a 12V nominal output.

Figure 11 shows a typical variable Trim circuit. Using a 10kΩ trimpot (R7), the resistor values for R6 and R8 can be calculated as follows:

$$V_1 = V_{REF} + 10\% = 2.75V$$

Given: $V_{REF} = 2.5V$ (see Table 1)

$$I_{R5} = (2.75V - V_{REF})/R_{TH} = (2.75V - 2.5V)/10k\Omega = 25mA$$

Setting the bottom limit:

$$V_{R6} = 2.5V - 10\% = 2.25V$$

And since $I_{R5} = I_{R6} = 25mA$,

$$R6 = V_{R6} / I_{R6} = 2.25V / 25mA = 90k\Omega$$

$$V_2 = V_1 + V_{R6} = 2.75V + 2.25V = 5V$$

$$I_{R7} = V_2 / R7 = 5V / 10k\Omega = 500\mu A$$

$$I_{R8} = I_{R7} + I_{R6} = 525\mu A$$

$$V_{R8} = (V_{NOM} + 10\%) - V_2 = 13.2V - 5V = 8.2V$$

Given: $V_{NOM} = 12V$

$$R8 = V_{R8} / I_{R8} = 8.2V / 525\mu A = 15.62k\Omega$$

Using the above resistor combination, a 12V output can be trimmed externally up to 13.2V and down to 10.8V. For further information on external trimming, refer to Chapter 5 of the VI-200™ / VI-J00 Design Guide and Applications Manual or consult the factory for assistance.

CONSULT APPLICATIONS ENGINEERING WHEN TRIMMING OUTPUTS BELOW 5V.

Specifications

Input Characteristics		
Input Voltage	85 – 264V _{AC} , 47 – 500Hz 100 – 380V _{DC}	
Power Factor	0.99 at 115V _{AC} ; 0.95 at 230V _{AC}	
Inrush Current	25A _{PK} at 115V _{AC} and 230V _{AC}	
Ride-Through Time	>20ms at nominal line, full load	
Power Fail	>3ms warning	
Conducted EMI	EN55022 Class A; FCC Class A (Certain configurations meet B. Contact factory)	
Surge Immunity	EN 61000-4-5 Installation Class 3, Performance Criteria B (Temporary loss of output power may occur which is self recoverable)	
Dielectric Withstand	Primary to Chassis GND = 2,121V _{DC} Primary to Secondary = 4,242V _{DC} Secondary to Chassis GND = 750V _{DC}	
Output Characteristics		
Line/Load Regulation	VI-200™ / VI-J00™: ±0.2% max.10% to full load ±0.5% max. No load to 10% load	
Line Regulation ^[f]	Maxi: ±0.20% max. to 0.3% max LL to HL, Full Load	
Load Regulation ^[f]	Maxi: ±0.1% No load to full load	
VI-200/VI-J00 Set Point Accuracy ^[f]	1% for standard voltages; 2% for special or adjustable voltages	
Maxi Setpoint Accuracy	1% for standard voltages; 2% for special, adjustable voltages and 48V _{DC} outputs	
Ripple and Noise	0.15% or 10mV _{P-P} whichever is greater, 75% min. load	
Output Trim Range	10 – 110% of nominal voltage Maxi modules 50 – 110% of nominal voltage VI-200 / VI-J00 modules 90 – 110% of nominal voltage VI-200 / VI-J00 modules 10 – 15V	
Overcurrent Trip Point	105 – 125% of full load capability of VI-200 / VI-J00 modules 115% typical of full load capability of Maxi modules	
Overvoltage Protection	115 – 135% on VI-200 on QPAC™ and FinQPAC™	
Efficiency	80% typical	
Output Power	PFC MegaPAC-EL™	PFC MegaPAC-HPEL™
	1,600W at 230V _{AC}	2,400W at 230V _{AC}
	1,200W at 115V _{AC} ^[f]	1,200W at 115V _{AC} ^[f]

^[f] Not to exceed an input current of 15A.

Environmental Characteristics		
Storage Temperature	-40 to 85°C	
Altitude	De-rate 2.6% total output power for each 1,000ft to a maximum operating altitude of 15,000ft. Non-operating storage maximum altitude is 40,000ft.	
Operating Temperature ^[9]	-20 to 40°C full power; -20 to 60°C half power	
Humidity	0 – 95% non-condensing	
Safety Agency Approvals	cURus – UL 60950-1, CSA 60950-1 cTUVus – EN 60950-1, UL 60950-1, CSA 60950-1 CE Mark – Low Voltage Directive, 73/23/EEC amended by 93/68/EEC	
Product Weights (fully configured)	PFC MegaPAC-EL™	PFC MegaPAC-HPEL™
	12.8lbs [5,8 kgs]	13.1lbs [6 kgs]
Warranty	2 years limited warranty. See www.vicorpower.com for complete warranty statement.	

See Vicor module specifications. A preload may be necessary for modules trimmed down below 90% of normal output voltage.

^[9] The maximum operating temperature is 40°C. If using a VI-200 with output voltage less than 12V and more than 150W, the operating temperature decreases to 35°C. This also applies when using a FinQPAC™ with output voltage less than 24V and more than 500W.

Output Studs

New, more robust output studs (with a 3:1 safety margin at 45lbs-in) were installed in ConverterPACs™, the slide-in assemblies used in the MegaPAC™ Family. These new outputs studs are 1/8" longer to allow for multiple lugs. They are fully compatible with the original flanged nut ConverterPACs for use in parallel arrays.

Other advantages include:

- Inner nut (that might become loose) replaced by a brass insert
- Stronger connection to the PCB
- Improved conductivity (less voltage drop and heating)
- Both the stud and panel are less likely to break due to over torquing

Shown below are the original and redesigned studs.

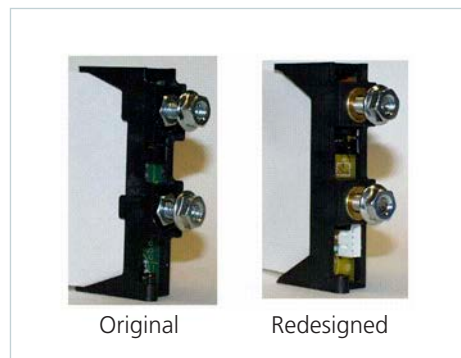

Refer to Page 14 for dimensional data.

Output Power De-Rating



PFC MegaPAC-EL™ and -HPEL Connector Kit (19-130040) Listing

Item	Qty	Description	Vendor #1	Part #
1	1	HOUSING 12 POS.165 CTR W/LATCH	MOLEX	39-01-2120
2	12	TERMINAL FEM CRIMP 18-24AWG TIN	MOLEX	39-00-0039
**		CRIMP TOOL FOR ITEM 2	MOLEX	11-01-0197
3	8	HOUSING 7 POS.098 CTR L/PROFILE	MOLEX	39-01-0073
4	8	HOUSING 4 POS.098 CTR L/PROFILE	MOLEX	39-01-0043
5	94	TERMINAL FEM CRIMP 22 – 18AWG PH/BRNZ	MOLEX	39-01-0031
**		CRIMP TOOL FOR ITEMS 3 & 4	MOLEX	00-01-0197
6	8	HOUSING 3 POS.1 CTRS W/LATCH	MOLEX	50-57-9403
7	27	TERMINAL FEM CRIMP 22-24AWG SEL/GLD	MOLEX	16-02-0103
**		CRIMP TOOL FOR ITEM 7	MOLEX	11-01-0118

** ITEMS FOR REFERENCE ONLY (NOT INCLUDED IN KIT)

Connector Kit for Dual Outputs only - MegaPAC™ Family 19-130042

Item	Qty	Description	Vendor #1	Part #
1	1	HOUSING 3 POS.100 CTR W/LATCH	MOLEX	50-57-9403
2	6	TERMINAL FEM CRIMP 22-24AWG SEL GOLD	MOLEX	16-02-0103
**		CRIMP TOOL FOR ITEM 2	MOLEX	11-01-0118
3	2	HOUSING 6 POS.165 CTR W/LATCH	MOLEX	39-01-2060
4	12	TERMINAL FEM CRIMP 18-24AWG TIN	MOLEX	39-01-0039
**		CRIMP TOOL FOR ITEM 4	MOLEX	11-01-0197

** ITEMS FOR REFERENCE ONLY (NOT INCLUDED IN KIT)

Current Share Boards - Optional Feature

"Current Sharing" also known as Load Sharing, is the ability to divide the output current evenly across all active power supplies. This greatly reduces stresses on each power supply and allows them to run cooler, resulting in higher reliability. Standard "current sharing" techniques typically utilize shunt resistors or Hall-Effect devices to measure the current from each power supply. Power shunt resistors continually dissipate power and require cooling especially when dealing with high-output currents of >100A. Hall-Effect devices measure magnetic fields generated by current flowing through a conductor and although they dissipate no power, they tend to be large and expensive.

First developed by Vicor Engineering for paralleling MegaPAC™ supplies, the box-to-Box Current Share Board or CSB allows two or more Vicor power supplies to current share by utilizing the inherent voltage drop produced in the negative output return cable. This eliminates the need for additional shunt resistors or expensive Hall-Effect devices and provides a simple five-wire connection method to achieve a $\pm 1\text{mV}$ accuracy between the Negative Output power rails. This accuracy translates to a 1% current sharing if there is a total of 100mV conduction voltage drop in the negative return path.

Constructed as a current source to drive the Trim pin of a Vicor module, the design uses an accurate comparator circuit to monitor the power returns. In addition, the circuit is unidirectional and can only trim an output voltage up. The benefit is that only the supply that is supporting less current is adjusted up. This action balances the currents to the load by matching the output voltages of the supplies. In the case of one supply failing, the circuit will attempt to trim the failed supply only. This will leave the remaining functional supply alone to provide power to the load at its nominal voltage. Thus the circuit also offers simple redundancy. In addition, because CSB functions as a current source, the Trim outputs (T1 and T2) of the CSB can be placed in parallel to create a summing node. This allows current sharing between more than two supplies by paralleling the T2 output of one CSB circuit with the T1 output of the next CSB.

Please note: The CSB is not intended for use in hot-swap Applications.

Figure 12
CSB interconnect example



(Requirements on Page 26).

Requirements:

1. For proper operation, the power supplies being paralleled should be enabled at the same time.
2. –Out conductors must be of equal length and wire gauge.
Separate –Out conductors must be used from each supply to the load or the use of a "Y" connection to a common point must be used as shown in Figure 12. Each leg of the "Y" must have a minimum of a few millivolts of drop in order for proper operation. 50 – 100mV of drop will provide from 5 to 1% accuracy.
3. –V1 and –V2 for all box-to-box circuits must be connected directly at the negative output power studs or terminals to achieve accurate current sharing.
4. D* can be added if redundancy is needed. If redundancy is not required, D* can be replaced with direct wire connections.
5. When using D*, the Power input should be connected on the cathode side of the paralleling diodes as shown in Figure 12.
6. Terminate Sense Leads either locally or remotely as shown in Figure 12.
7. For paralleling more than two supplies consult factory for assistance.

Current Share Boards - Optional Feature Diagram

Figure 13
Mechanical drawing



Figure 14
Cable drawing



Specifications:

1. Power: 2 – 50V_{DC} at 5mA maximum.
2. Accuracy: $\pm 1\text{mV}$ between -VOUT connections.
3. Output current when not trimming up: $\pm 1\mu\text{A}$ (VI-200 / J00), $\pm 5\mu\text{A}$ (Maxi).
4. Use four, non-plated through holes with standoffs for mounting.
5. CSB01 MUST be used for current sharing VI-200™ / VI-J00™ converters (VI-200 / J00).
6. CSB02 MUST be used for current sharing Maxi converters (Maxi, Mini and Micros).

PLEASE NOTE, THE CSB IS NOT INTENDED FOR HOTSWAP APPLICATIONS

Contact your Regional Applications Engineer at: apps@vicorpower.com for additional information.

Output Sequencing

Using the MegaPAC's™ standard Input Interface Connector (J10) along with the ConverterPAC's™ optional DC OK Option, it is possible to implement unique output voltage power-up and power-down sequences. Below is an example showing how this may be done.

Requirement: 5V must start before the 3.3V output. If the 5V output is lost, the 3.3V output must turn off.

The first step in meeting this requirement is to configure the 5V QPAC™ with the DC OK Option, which is indicated by a "D" designator in the QPAC's part number, located on the top surface of each QPAC above the $+V_{OUT}$. Any QPAC that has the DC OK option will also have the four-Pin J3 DC OK connector installed. To order a QPAC with the DC OK option, please contact the Vicor customer service department for assistance. The DC OK option monitors the output voltage of a given ConverterPAC and provides a TTL logic signal depending on its output voltage.

Figure 17 shows the correct wiring connections between the Power Good Connector (J3) of a 5V QPAC and the Input Interface Connector (J10) of a typical PFC MegaPAC-EL configuration. In this example, the 3.3V QPAC is located in the slot #7 and the 5V QPAC (with the DC OK option) is located in slot #8. In order for the Power Good option to properly function, it requires a 5V source to provide the necessary VCC pull up. This 5V source is conveniently available using the +5V aux source from the Input Interface Connector (J10-9 and J10-10). With a VCC voltage properly applied to the 5V QPAC's Power Good Connector (J3-1 and J3-4), the Power Good signal (J3-3) can now be connected to the Enable / Disable control pin for slot #7 (J10-7). The 5V QPAC's Power Good signal will remain low until its output has reached approximately 95% of its nominal output voltage. This will keep the 3.3V output in disabled mode, allowing the 5V output to reach regulation first. In addition, should the 5V output drop below 85% the Power Good signal will drop low and disable the 3.3V output. Figures 18 and 19 show the startup and shutdown waveforms for the circuit shown in Figure 17.

Figure 15
QPAC pinout



Figure 16
J3 DC OK connector



Figure 17
Output sequencing
wire interconnect



- Channel #1: 5V Output
- Channel #2: 3.3V Output
- Channel #3: 5V DC OK signal

Figure 18
Start-up waveforms



Figure 19
Shut-down waveforms



For more information about this or other Vicor products, or for assistance with component-based power system design, contact the Vicor office nearest you. The Vicor comprehensive line of power solutions includes modular, high-density DC-DC converters and accessory components, configurable power supplies and custom power systems. Vicor designs and builds configurable power supplies incorporating its high-density DC-DC converters and accessory components.

This product line includes:

LoPAC™ FAMILY:

- PFC MicroS
- PFC Micro
- PFC Mini

MegaPAC™ FAMILY:

- PFC MegaPAC™
- 4kW MegaPAC
- PFC MegaPAC (High Power)
- PFC MegaPAC (Low Noise/High Power)
- PFC MegaPAC-EL™ (Low Noise)
- Mini MegaPAC™
- ConverterPACs™

OTHERS:

- FlatPAC-EN™

Rugged COTS versions (MI) are available for the PFC Micro, PFC MicroS, PFC Mini and PFC MegaPAC.

Limitation of Warranties

Information in this document is believed to be accurate and reliable. HOWEVER, THIS INFORMATION IS PROVIDED "AS IS" AND WITHOUT ANY WARRANTIES, EXPRESSED OR IMPLIED, AS TO THE ACCURACY OR COMPLETENESS OF SUCH INFORMATION. VICOR SHALL HAVE NO LIABILITY FOR THE CONSEQUENCES OF USE OF SUCH INFORMATION. IN NO EVENT SHALL VICOR BE LIABLE FOR ANY INDIRECT, INCIDENTAL, PUNITIVE, SPECIAL OR CONSEQUENTIAL DAMAGES (INCLUDING, WITHOUT LIMITATION, LOST PROFITS OR SAVINGS, BUSINESS INTERRUPTION, COSTS RELATED TO THE REMOVAL OR REPLACEMENT OF ANY PRODUCTS OR REWORK CHARGES).

Vicor reserves the right to make changes to information published in this document, at any time and without notice. You should verify that this document and information is current. This document supersedes and replaces all prior versions of this publication.

All guidance and content herein are for illustrative purposes only. Vicor makes no representation or warranty that the products and/or services described herein will be suitable for the specified use without further testing or modification. You are responsible for the design and operation of your applications and products using Vicor products, and Vicor accepts no liability for any assistance with applications or customer product design. It is your sole responsibility to determine whether the Vicor product is suitable and fit for your applications and products, and to implement adequate design, testing and operating safeguards for your planned application(s) and use(s).

VICOR PRODUCTS ARE NOT DESIGNED, AUTHORIZED OR WARRANTED FOR USE IN LIFE SUPPORT, LIFE-CRITICAL OR SAFETY-CRITICAL SYSTEMS OR EQUIPMENT. VICOR PRODUCTS ARE NOT CERTIFIED TO MEET ISO 13485 FOR USE IN MEDICAL EQUIPMENT NOR ISO/TS16949 FOR USE IN AUTOMOTIVE APPLICATIONS OR OTHER SIMILAR MEDICAL AND AUTOMOTIVE STANDARDS. VICOR DISCLAIMS ANY AND ALL LIABILITY FOR INCLUSION AND/OR USE OF VICOR PRODUCTS IN SUCH EQUIPMENT OR APPLICATIONS AND THEREFORE SUCH INCLUSION AND/OR USE IS AT YOUR OWN RISK.

Terms of Sale

The purchase and sale of Vicor products is subject to the Vicor Corporation Terms and Conditions of Sale which are available at: (<http://www.vicorpower.com/termsconditionswarranty>)

Export Control

This document as well as the item(s) described herein may be subject to export control regulations. Export may require a prior authorization from U.S. export authorities.

Contact Us: <http://www.vicorpower.com/contact-us>

Vicor Corporation

25 Frontage Road
Andover, MA, USA 01810
Tel: 800-735-6200
Fax: 978-475-6715
www.vicorpower.com

email

Customer Service: custserv@vicorpower.com
Technical Support: apps@vicorpower.com

©2018 Vicor Corporation. All rights reserved. The Vicor name is a registered trademark of Vicor Corporation. All other trademarks, product names, logos and brands are property of their respective owners.

Mouser Electronics

Authorized Distributor

Click to View Pricing, Inventory, Delivery & Lifecycle Information:

Vicor:

[MX4-7617373-2](#) [M6V_20A](#) [M5V2V_28A8AIT2](#) [M5V2V_19A2AIV2](#) [MP1-783196](#) [MP1-787515](#) [MX4-777501-G](#)
[MX7-7813297-2](#) [MP7-7732](#) [MX2-7715792-2](#) [MP1-777814](#) [MX7-71010498-2-EL](#) [MX4-7411884-2](#) [WX2-748377-G](#)
[MX1-7717105-MC](#) [MP4-775952](#) [MX6-7612830-2](#) [MX1-7412604-2](#) [WX8-799911-G](#) [WX5-41013237-2](#) [WX1-7312854-](#)
[G](#) [MP5-77566](#) [WP6-76612](#) [MX3-7412645-G-EL](#) [WP9-79512](#) [WM4-1465](#) [MX1-7414883-2](#) [MP1-739560](#) [MP1-](#)
[787300-G](#) [MX4-746347-2](#) [WX1-7412474-G](#) [MX6-7716938-MC](#) [MP2-74516](#) [MX4-7816959-MI](#) [MX1-7114050-2](#) [MX5-](#)
[7513967-2](#) [MX1-7314716-G](#) [MX1-7411697-MC](#) [MX8-7815286-2](#) [MX7-7911589-2](#) [WP3-77544](#) [MX6-7611191-G-EL](#)
[MX4-7512624-2-EL](#) [MX1-7111981-2](#) [MX2-7411032-MI](#) [MX6-7712520-2](#) [WP6-76594](#) [WP8-793747-EL](#) [MX7-](#)
[7411888-G](#) [MP13-7132437-EL](#) [MX2-749656-G](#) [MX16-71615972-2](#) [WP4-7810305-EL](#) [MX2-7815201-MC](#) [WM4-](#)
[14654](#) [MP1-725343](#) [MX3-7413659-MC](#) [WP2-78532](#) [MX3-7415359-2-EL](#) [MP1-719049](#) [WX1-4613216-2](#) [WM4-](#)
[1414042-G](#) [WX1-7314715-2](#) [MX1-7317381-G](#) [WP1-434122-2](#) [WX3-7515925-2](#) [MP2-78540](#) [MP4-76543](#) [WX5-](#)
[4915968-2](#) [MP6-78576](#) [MP2-753427](#) [MP5-749201](#) [WP4-746127](#) [MP2-761071-EL](#) [WM5-15632](#) [MP5-78537](#) [MP1-](#)
[766746](#) [MX1-7415876-MI](#) [MX8-7916819-MC](#) [MP8-78569](#) [MP1-784420](#) [MX3-7517236-2](#) [MP14-7143200-2-EL](#) [WP1-](#)
[756944-G-EL](#) [WX7-41114805-2](#) [MP4-7710003-G](#) [MP4-78614](#) [MP10-711502](#) [WP7-78566](#) [WX1-4108946-2](#) [WX1-](#)
[7411652-2](#) [MX5-7813460-2](#) [MX3-7314590-G-EL](#) [MX8-7811704-2](#) [WP3-769117-EL](#) [WX2-7414627-G](#) [WX6-7611314-](#)
[2-EL](#) [WX7-782874-EL](#) [WX5-7613482-2](#) [WX3-4105827-2](#)

Компания «Life Electronics» занимается поставками электронных компонентов импортного и отечественного производства от производителей и со складов крупных дистрибьюторов Европы, Америки и Азии.

С конца 2013 года компания активно расширяет линейку поставок компонентов по направлению коаксиальный кабель, кварцевые генераторы и конденсаторы (керамические, пленочные, электролитические), за счёт заключения дистрибьюторских договоров

Мы предлагаем:

- Конкуренспособные цены и скидки постоянным клиентам.
- Специальные условия для постоянных клиентов.
- Подбор аналогов.
- Поставку компонентов в любых объемах, удовлетворяющих вашим потребностям.
- Приемлемые сроки поставки, возможна ускоренная поставка.
- Доставку товара в любую точку России и стран СНГ.
- Комплексную поставку.
- Работу по проектам и поставку образцов.
- Формирование склада под заказчика.
- Сертификаты соответствия на поставляемую продукцию (по желанию клиента).
- Тестирование поставляемой продукции.
- Поставку компонентов, требующих военную и космическую приемку.
- Входной контроль качества.
- Наличие сертификата ISO.

В составе нашей компании организован Конструкторский отдел, призванный помогать разработчикам, и инженерам.

Конструкторский отдел помогает осуществить:

- Регистрацию проекта у производителя компонентов.
- Техническую поддержку проекта.
- Защиту от снятия компонента с производства.
- Оценку стоимости проекта по компонентам.
- Изготовление тестовой платы монтаж и пусконаладочные работы.



Тел: +7 (812) 336 43 04 (многоканальный)

Email: org@lifeelectronics.ru