

SJxx10xSx & SJxx10xx Series

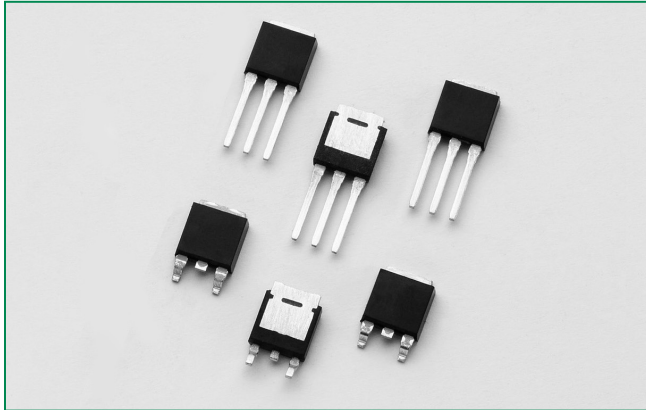

Main Features

Symbol	Value	Unit
$I_{T(RMS)}$	10	A
V_{DRM}/V_{RRM}	400 or 600	V
I_{GT}	0.2 to 15	mA

Schematic Symbol

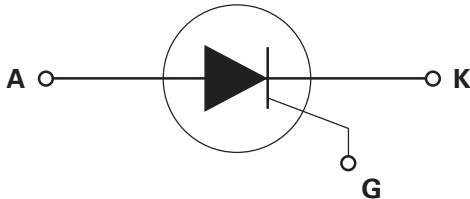

Description

This SJxx10xx high temperature SCR series is ideal for uni-directional switch applications such as phase control, heating, motor speed controls, converters/rectifiers and capacitive discharge ignitions.

These SCRs have a low gate current trigger level of 6mA or 15mA maximum at approximately 1.5V, with a sensitive version of this series having a gate trigger current less than 200 μ A. The sensitive gate SCR version is easily triggered by sense coils, proximity switches, and microprocessors.

Features & Benefits

- Voltage capability up to 600 V
- Surge capability up to 100 A at 60 Hz half cycle
- 150 °C maximum junction temperature
- Halogen free and RoHS compliant

Applications

Typical applications includes capacitive discharge system for motorcycle engine CDI, portable generator engine ignition, strobe lights and nailers, as well as generic rectifiers, battery voltage regulators and converters. Also controls for power tools, home/brown goods and white goods appliances.

Absolute Maximum Ratings – Sensitive SCRs

Symbol	Parameter	Test Conditions	Value	Unit
$I_{T(RMS)}$	RMS on-state current	$T_c = 120\text{ }^\circ\text{C}$	10	A
$I_{T(AV)}$	Average on-state current	$T_c = 120\text{ }^\circ\text{C}$	6.4	A
I_{TSM}	Peak non-repetitive surge current	single half cycle; $f = 50\text{ Hz}$; $T_J(\text{initial}) = 25\text{ }^\circ\text{C}$	83	A
		single half cycle; $f = 60\text{ Hz}$; $T_J(\text{initial}) = 25\text{ }^\circ\text{C}$	100	
I^2t	I^2t Value for fusing	$t_p = 8.3\text{ ms}$	41	A^2s
di/dt	Critical rate of rise of on-state current	$f = 60\text{ Hz}, T_J = 150\text{ }^\circ\text{C}$	100	$\text{A}/\mu\text{s}$
I_{GM}	Peak gate current	$P_w = 20\text{ }\mu\text{s}, T_J = 150\text{ }^\circ\text{C}$	0.5	A
$P_{G(AV)}$	Average gate power dissipation	$T_J = 150\text{ }^\circ\text{C}$	0.1	W
T_{stg}	Storage temperature range		-40 to 150	$^\circ\text{C}$
T_J	Operating junction temperature range		-40 to 150	$^\circ\text{C}$
V_{DSM}/V_{RSM}	Peak non-repetitive blocking voltage	$P_w = 100\text{ }\mu\text{s}$	$V_{DRM}/V_{RRM} + 100$	V

Absolute Maximum Ratings – Standard SCRs

Symbol	Parameter	Test Conditions	Value	Unit
$I_{T(RMS)}$	RMS on-state current	$T_C = 125\text{ }^\circ\text{C}$	10	A
$I_{T(AV)}$	Average on-state current	$T_C = 125\text{ }^\circ\text{C}$	6.4	A
I_{TSM}	Peak non-repetitive surge current	single half cycle; $f = 50\text{ Hz}$; T_J (initial) = $25\text{ }^\circ\text{C}$	83	A
		single half cycle; $f = 60\text{ Hz}$; T_J (initial) = $25\text{ }^\circ\text{C}$	100	
I^2t	I^2t Value for fusing	$t_p = 8.3\text{ ms}$	41	A^2s
di/dt	Critical rate-of-rise of on-state current	$f = 60\text{ Hz}$; $T_J = 150\text{ }^\circ\text{C}$	100	$\text{A}/\mu\text{s}$
I_{GM}	Peak gate current	$Pw=20\text{ }\mu\text{s}$, $T_J = 150\text{ }^\circ\text{C}$	0.5	A
$P_{G(AV)}$	Average gate power dissipation	$T_J = 150\text{ }^\circ\text{C}$	0.1	W
T_{stg}	Storage temperature range		-40 to 150	$^\circ\text{C}$
T_J	Operating junction temperature range		-40 to 150	$^\circ\text{C}$
V_{DSM}/V_{RSM}	Peak non-repetitive blocking voltage	$Pw=100\text{ }\mu\text{s}$	$V_{DRM}/V_{RRM} + 100$	V

Electrical Characteristics ($T_J = 25\text{ }^\circ\text{C}$, unless otherwise specified) – Sensitive SCRs

Symbol	Test Conditions		Value	Unit
			SJxx10xS2	
I_{GT}	$V_D = 6\text{ V}$, $R_L = 100\text{ }\Omega$	MIN.	20	μA
		MAX.	200	μA
V_{GT}		MAX.	0.8	V
dv/dt	$V_D = V_{DRM}$; $R_{GK} = 220\text{ }\Omega$; $T_J = 125\text{ }^\circ\text{C}$	MIN.	15	$\text{V}/\mu\text{s}$
V_{GD}	$V_D = V_{DRM}$; $R_L = 3.3\text{ k}\Omega$; $T_J = 125\text{ }^\circ\text{C}$	MIN.	0.2	V
	$V_D = V_{DRM}$; $R_L = 3.3\text{ k}\Omega$; $T_J = 150\text{ }^\circ\text{C}$	MIN.	0.1	V
V_{GRM}	$I_{GR} = 10\text{ }\mu\text{A}$	MIN.	6	V
I_H	$I_T = 20\text{ mA}$ (initial)	MAX.	6	mA
t_q	$t_p=50\text{ }\mu\text{s}$; $dv/dt=5\text{ V}/\mu\text{s}$; $di/dt=-30\text{ A}/\mu\text{s}$	MAX.	130	μs
t_{gt}	$I_G = 2 \times I_{GT}$; $PW = 15\text{ }\mu\text{s}$; $I_T = 10\text{ A}$	TYP.	6	μs

NOTE: xx = voltage

Electrical Characteristics ($T_J = 25\text{ }^\circ\text{C}$, unless otherwise specified) – Standard SCRs

Symbol	Test Conditions		Value		Unit
			SJxx10x1	SJxx10x	
I_{GT}	$V_D = 12\text{ V}$, $R_L = 60\text{ }\Omega$	MAX.	6	15	mA
V_{GT}		MAX.	1.5	1.5	V
dv/dt	$V_D = V_{DRM}$; gate open; $T_J = 125\text{ }^\circ\text{C}$	MIN.	100	200	$\text{V}/\mu\text{s}$
	$V_D = V_{DRM}$; gate open; $T_J = 150\text{ }^\circ\text{C}$		50	120	
V_{GD}	$V_D = V_{DRM}$; $R_L = 3.3\text{ k}\Omega$; $T_J = 125\text{ }^\circ\text{C}$	MIN.	0.2	0.2	V
	$V_D = V_{DRM}$; $R_L = 3.3\text{ k}\Omega$; $T_J = 150\text{ }^\circ\text{C}$	MIN.	0.1	0.1	
I_H	$I_T = 200\text{ mA}$ (initial)	MAX.	20	30	mA
t_q	$I_T=0.5\text{ A}$; $t_p=50\text{ }\mu\text{s}$; $dv/dt=5\text{ V}/\mu\text{s}$; $di/dt=-30\text{ A}/\mu\text{s}$	MAX.	30	35	μs
t_{gt}	$I_G = 2 \times I_{GT}$; $PW = 15\text{ }\mu\text{s}$; $I_T = 10\text{ A}$	TYP.	0.5	2	μs

NOTE: xx = voltage

Static Characteristics

Symbol	Test Conditions		Value	Unit		
V_{TM}	$I_T = 20A; t_p = 380 \mu s$		MAX.	1.6	V	
I_{DRM} / I_{RRM}	@ V_{DRM} / V_{RRM}	SJxx10xS2	MAX.	$T_J = 25^\circ C$	5	μA
				$T_J = 125^\circ C, R_{GK} = 220 \Omega$	1000	
				$T_J = 150^\circ C, R_{GK} = 220 \Omega$	3000	
		SJxx10xx	$T_J = 25^\circ C$	10		
			$T_J = 125^\circ C$	1000		
			$T_J = 150^\circ C$	3000		

Thermal Resistances

Symbol	Parameter	Value	Unit
$R_{\theta(J-C)}$	Junction to case (AC)	SJxx10xS2	1.2
		SJxx10xx	1.2

Note: xx = voltage

Figure 1: Normalized DC Gate Trigger Current vs. Junction Temperature (Sensitive SCR)

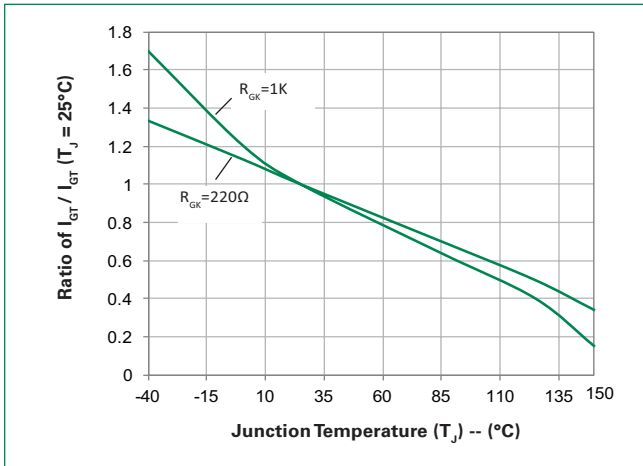

Figure 2: Normalized DC Gate Trigger Current vs. Junction Temperature (Standard SCR)

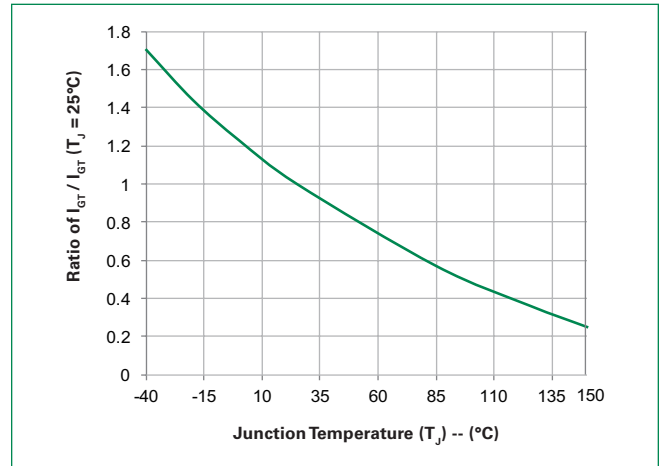

Figure 3: Normalized DC Gate Trigger Voltage vs. Junction Temperature



Figure 4: Normalized DC Holding Current vs. Junction Temperature

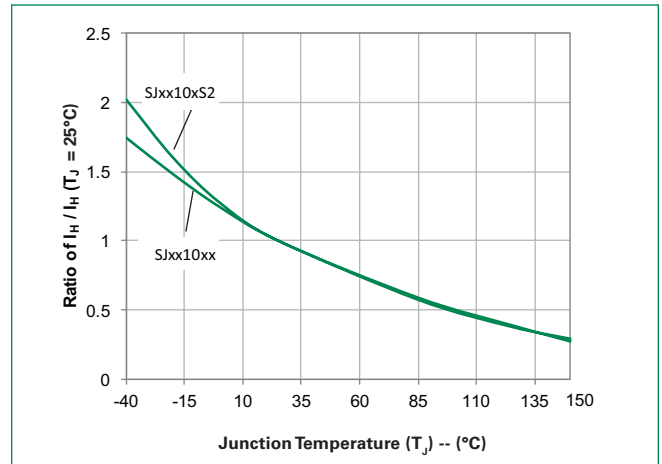

Figure 5: On-State Current vs. On-State Voltage (Typical)

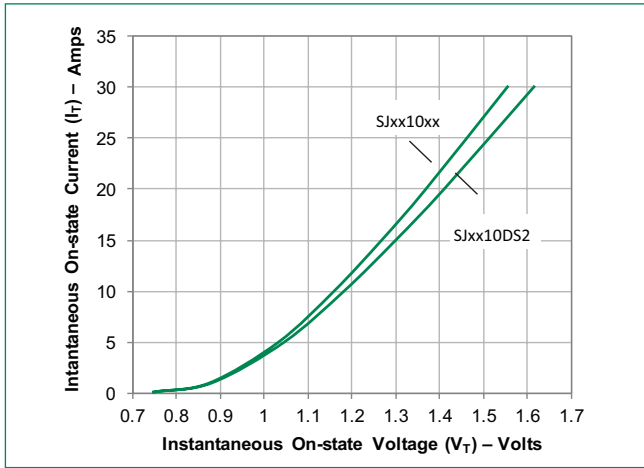

Figure 6: Power Dissipation (Typical) vs. RMS On-State Current

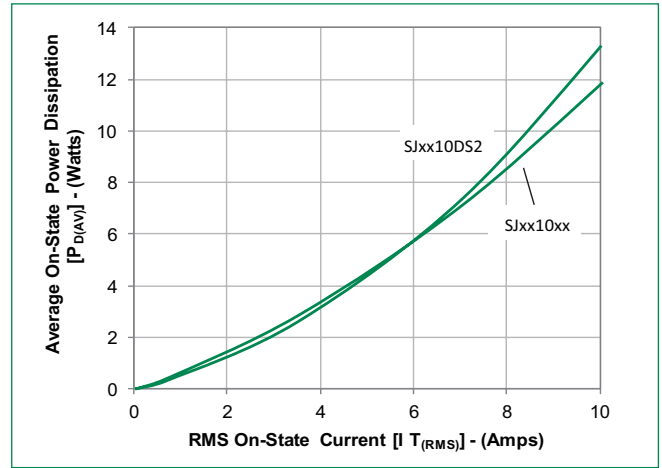

Figure 7: Maximum Allowable Case Temperature vs. RMS On-State Current

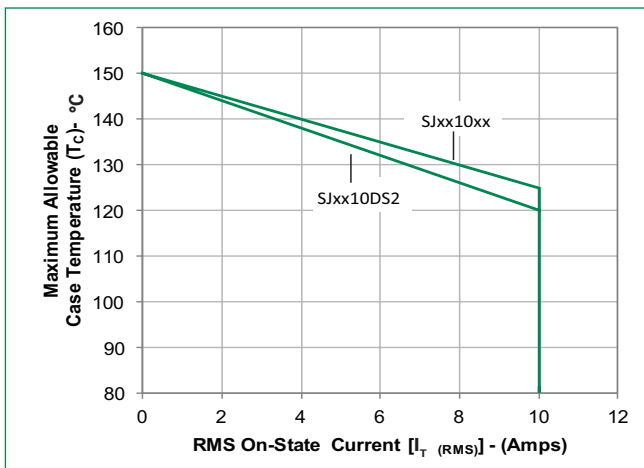

Figure 8: Maximum Allowable Case Temperature vs. Average On-State Current

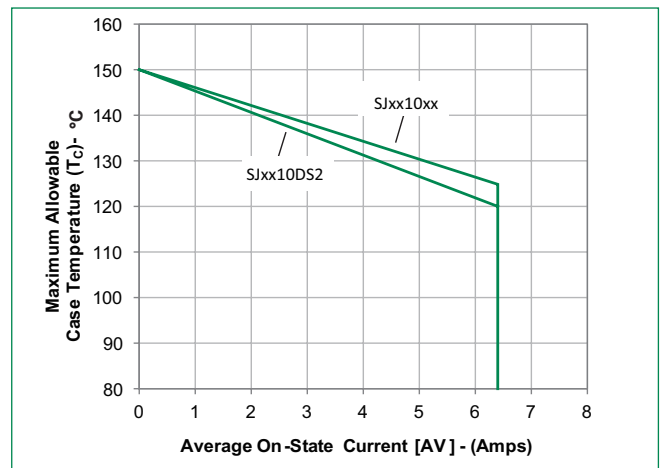

Figure 9: Peak Capacitor Discharge Current

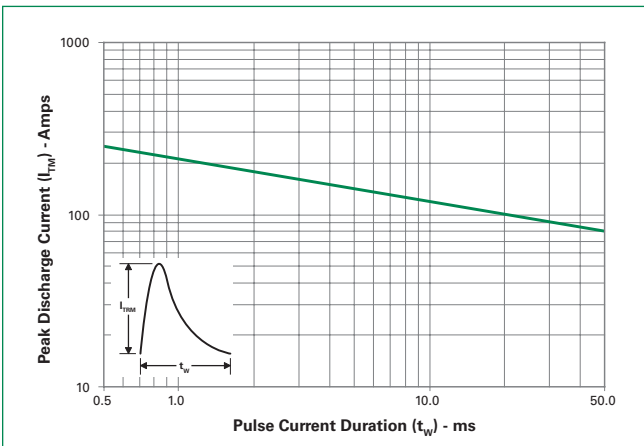

Figure 10: Surge Peak On-State Current vs. Number of Cycles

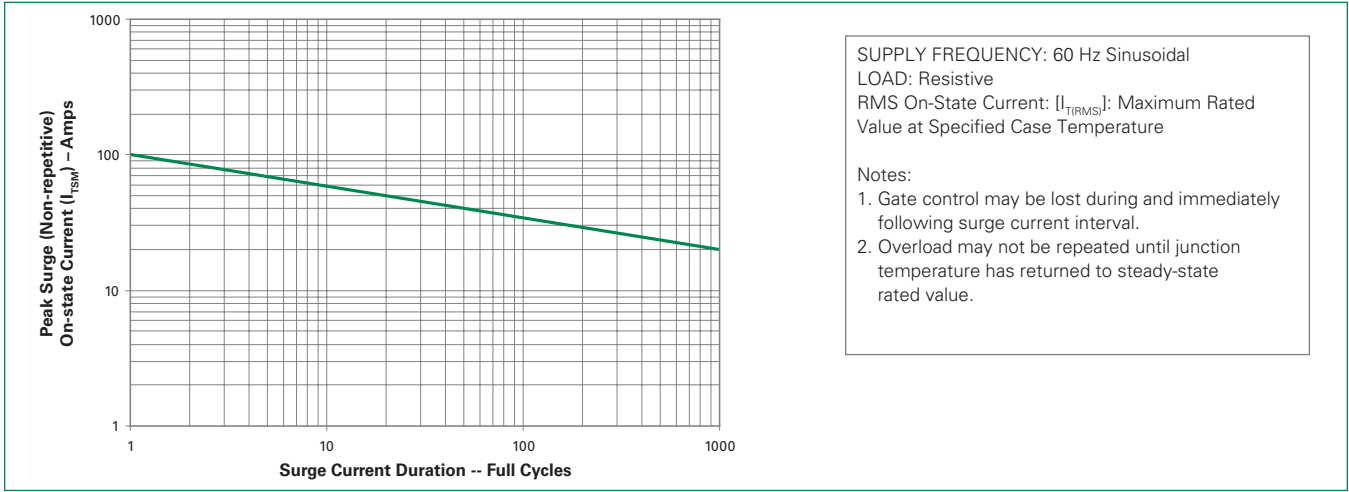

Figure 11: Typical DC Gate Trigger Current with R_{GK} vs. Junction Temperature (Sensitive SCR)



Figure 12: Typical DC Holding Current with R_{GK} vs. Junction Temperature (Sensitive SCR)

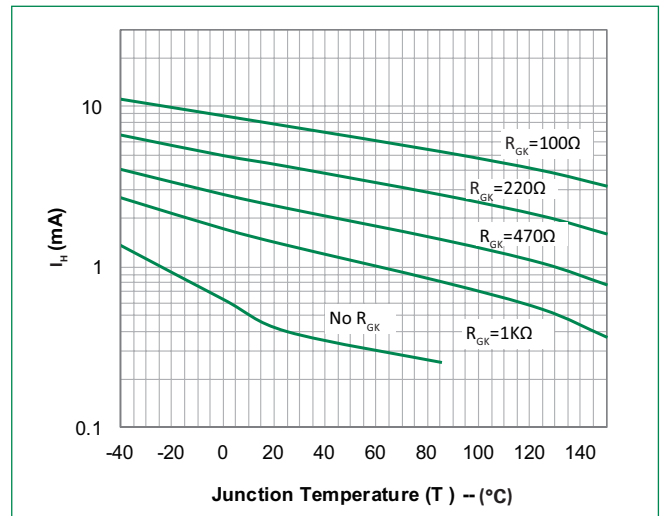
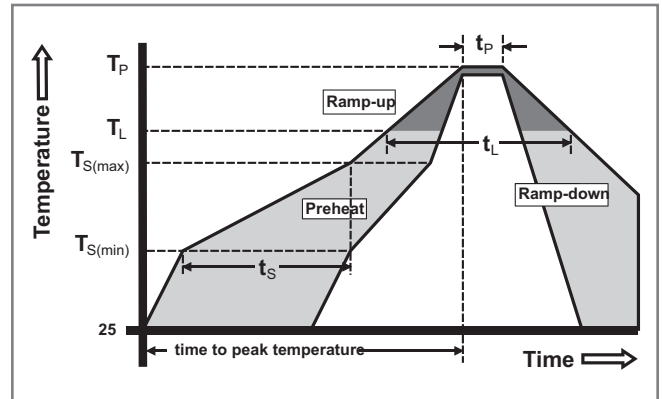

Figure 13: Typical Static dv/dt with R_{GK} vs. Junction Temperature (Sensitive SCR)



Soldering Parameters

Reflow Condition		Pb – Free assembly
Pre Heat	- Temperature Min ($T_{s(min)}$)	150°C
	- Temperature Max ($T_{s(max)}$)	200°C
	- Time (min to max) (t_s)	60 – 180 secs
Average ramp up rate (Liquidus Temp) (T_L) to peak		5°C/second max
$T_{s(max)}$ to T_L - Ramp-up Rate		5°C/second max
Reflow	- Temperature (T_L) (Liquidus)	217°C
	- Time (t_L)	60 – 150 seconds
Peak Temperature (T_p)		260 ^{+0/-5} °C
Time within 5°C of actual peak Temperature (t_p)		20 – 40 seconds
Ramp-down Rate		5°C/second max
Time 25°C to peak Temperature (T_p)		8 minutes Max.
Do not exceed		280°C



Physical Specifications

Terminal Finish	100% Matte Tin-plated
Body Material	UL Recognized epoxy meeting flammability rating V-0
Lead Material	Copper Alloy

Design Considerations

Careful selection of the correct component for the application's operating parameters and environment will go a long way toward extending the operating life of the Thyristor. Good design practice should limit the maximum continuous current through the main terminals to 75% of the component rating. Other ways to ensure long life for a power discrete semiconductor are proper heat sinking and selection of voltage ratings for worst case conditions. Overheating, overvoltage (including dv/dt), and surge currents are the main killers of semiconductors. Correct mounting, soldering, and forming of the leads also help protect against component damage.

Environmental Specifications

Test	Specifications and Conditions
AC Blocking	MIL-STD-750, M-1040, Cond A Applied Peak AC voltage for 1008 hours
Temperature Cycling	MIL-STD-750, M-1051, 100 cycles; -40°C to +150°C; 15-min dwell-time
Temperature/Humidity	EIA / JEDEC, JESD22-A101 1008 hours; 160V - DC: 85°C; 85% rel humidity
High Temp Storage	MIL-STD-750, M-1031, 1008 hours; 150°C
Low-Temp Storage	1008 hours; -40°C
Resistance to Solder Heat	MIL-STD-750 Method 2031
Solderability	ANSI/J-STD-002, category 3, Test A
Lead Bend	MIL-STD-750, M-2036 Cond E
Moisture Sensitivity Level	Level 1, JEDEC-J-STD-020

Part Numbering System



Part Marking System

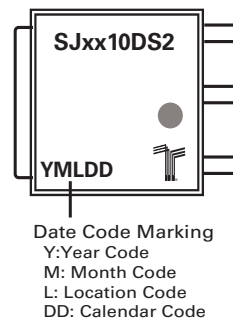

Dimensions — TO-251AA (V/I-Package) — V/I-PAK Through Hole

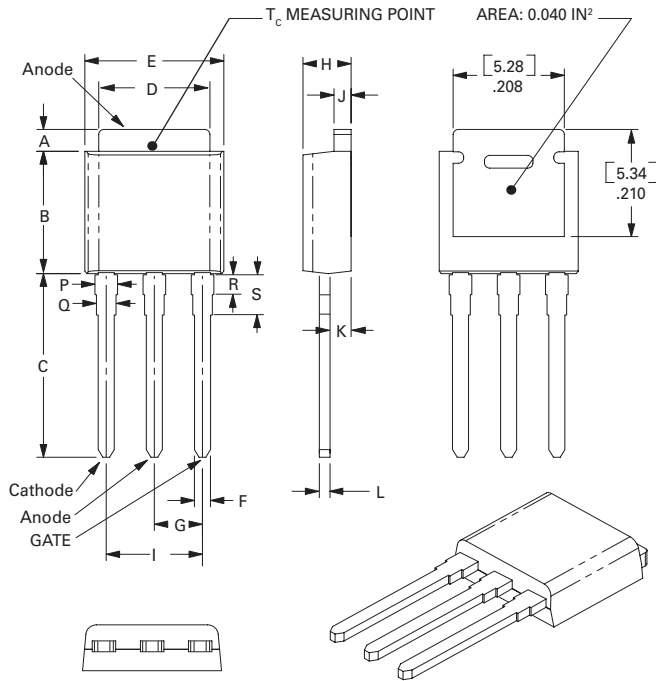

Dimension	Inches			Millimeters		
	Min	Typ	Max	Min	Typ	Max
A	0.037	0.040	0.043	0.94	1.01	1.09
B	0.235	0.242	0.245	5.97	6.15	6.22
C	0.350	0.361	0.375	8.89	9.18	9.53
D	0.205	0.208	0.213	5.21	5.29	5.41
E	0.255	0.262	0.265	6.48	6.66	6.73
F	0.027	0.031	0.033	0.69	0.80	0.84
G	0.087	0.090	0.093	2.21	2.28	2.36
H	0.085	0.092	0.095	2.16	2.34	2.41
I	0.176	0.180	0.184	4.47	4.57	4.67
J	0.018	0.020	0.023	0.46	0.51	0.58
K	0.035	0.037	0.039	0.90	0.95	1.00
L	0.018	0.020	0.023	0.46	0.52	0.58
P	0.042	0.047	0.052	1.06	1.20	1.32
Q	0.034	0.039	0.044	0.86	1.00	1.11
R	0.034	0.039	0.044	0.86	1.00	1.11
S	0.074	0.079	0.084	1.86	2.00	2.11

Dimensions — TO-252AA (D-Package) — D-PAK Surface Mount

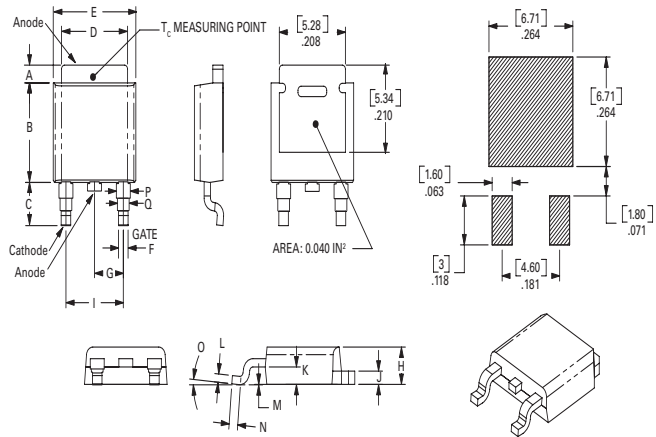

Dimension	Inches			Millimeters		
	Min	Typ	Max	Min	Typ	Max
A	0.037	0.040	0.043	0.94	1.01	1.09
B	0.235	0.243	0.245	5.97	6.16	6.22
C	0.106	0.108	0.113	2.69	2.74	2.87
D	0.205	0.208	0.213	5.21	5.29	5.41
E	0.255	0.262	0.265	6.48	6.65	6.73
F	0.027	0.031	0.033	0.69	0.80	0.84
G	0.087	0.090	0.093	2.21	2.28	2.36
H	0.085	0.092	0.095	2.16	2.33	2.41
I	0.176	0.179	0.184	4.47	4.55	4.67
J	0.018	0.020	0.023	0.46	0.51	0.58
K	0.035	0.037	0.039	0.90	0.95	1.00
L	0.018	0.020	0.023	0.46	0.51	0.58
M	0.000	0.000	0.004	0.00	0.00	0.10
N	0.021	0.026	0.027	0.53	0.67	0.69
O	0°	0°	5°	0°	0°	5°
P	0.042	0.047	0.052	1.06	1.20	1.32
Q	0.034	0.039	0.044	0.86	1.00	1.11

TO-252 Embossed Carrier Reel Pack (RP) Specifications

Meets all EIA-481-2 Standards

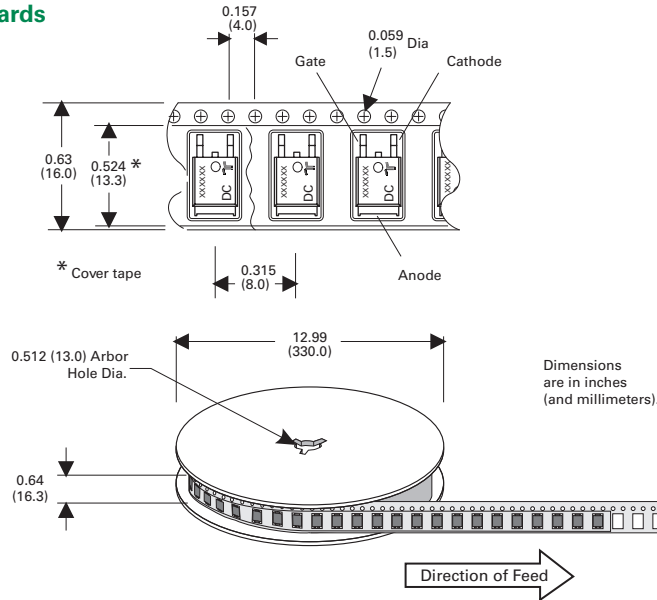

Product Selector

Part Number	Voltage		Gate Sensitivity	Type	Package
	400V	600V			
SJxx10VS2	X	X	0.2mA	Sensitive SCR	TO-251
SJxx10DS2	X	X	0.2mA	Sensitive SCR	TO-252
SJxx10V	X	X	15mA	Standard SCR	TO-251
SJxx10D	X	X	15mA	Standard SCR	TO-252
SJxx10V1	X	X	6mA	Standard SCR	TO-251
SJxx10D1	X	X	6mA	Standard SCR	TO-252

Note: xx = Voltage

Packing Options

Part Number	Marking	Weight	Packing Mode	Base Quantity
SJxx10DS2TP	SJxx10DS2	0.3 g	Tube	750 (75 per tube)
SJxx10DS2RP	SJxx10DS2	0.3 g	Embossed Carrier	2500
SJxx10VS2TP	SJxx10VS2	0.4 g	Tube	750 (75 per tube)
SJxx10DTP	SJxx10D	0.3 g	Tube	750 (75 per tube)
SJxx10DRP	SJxx10D	0.3 g	Embossed Carrier	2500
SJxx10VTP	SJxx10V	0.4 g	Tube	750 (75 per tube)
SJxx10D1TP	SJxx10D1	0.3 g	Tube	750 (75 per tube)
SJxx10D1RP	SJxx10D1	0.3 g	Embossed Carrier	2500
SJxx10V1TP	SJxx10V1	0.4 g	Tube	750 (75 per tube)

Note: xx = Voltage

Disclaimer Notice - Information furnished is believed to be accurate and reliable. However, users should independently evaluate the suitability of and test each product selected for their own applications. Littelfuse products are not designed for, and may not be used in, all applications. Read complete Disclaimer Notice at www.littelfuse.com/disclaimer-electronics.

Компания «Life Electronics» занимается поставками электронных компонентов импортного и отечественного производства от производителей и со складов крупных дистрибьюторов Европы, Америки и Азии.

С конца 2013 года компания активно расширяет линейку поставок компонентов по направлению коаксиальный кабель, кварцевые генераторы и конденсаторы (керамические, пленочные, электролитические), за счёт заключения дистрибьюторских договоров

Мы предлагаем:

- Конкурентоспособные цены и скидки постоянным клиентам.
- Специальные условия для постоянных клиентов.
- Подбор аналогов.
- Поставку компонентов в любых объемах, удовлетворяющих вашим потребностям.
- Приемлемые сроки поставки, возможна ускоренная поставка.
- Доставку товара в любую точку России и стран СНГ.
- Комплексную поставку.
- Работу по проектам и поставку образцов.
- Формирование склада под заказчика.
- Сертификаты соответствия на поставляемую продукцию (по желанию клиента).
- Тестирование поставляемой продукции.
- Поставку компонентов, требующих военную и космическую приемку.
- Входной контроль качества.
- Наличие сертификата ISO.

В составе нашей компании организован Конструкторский отдел, призванный помогать разработчикам, и инженерам.

Конструкторский отдел помогает осуществить:

- Регистрацию проекта у производителя компонентов.
- Техническую поддержку проекта.
- Защиту от снятия компонента с производства.
- Оценку стоимости проекта по компонентам.
- Изготовление тестовой платы монтаж и пусконаладочные работы.



Тел: +7 (812) 336 43 04 (многоканальный)

Email: org@lifeelectronics.ru