



Main

| | |
|---------------------------------------|--|
| Range of product | Preventa Safety detection |
| Product or component type | Safety light curtain type 4 |
| Device short name | XUSL4E |
| Output type | 2 safety outputs OSSD solid-state PNP (integrated arc suppression) |
| Product specific application | For hand protection |
| Minimum object diameter for detection | 1.18 in (30 mm) |
| [Sn] nominal sensing distance | 0...12 m by cabling 0...4 m by cabling |
| Height protected | 18.11 in (460 mm) |
| Number of beams | 23 |
| Type of start | Automatic Manual |
| Control type | Selected by wiring |

Complementary

| | |
|--------------------------------|--|
| Detection system | Transmitter-receiver system |
| Response time | 7.5 ms |
| Kit composition | Adjustable mounting bracket(s) 1 receiver(s) 1 transmitter(s) 1 user guide with certificate of conformity on CD-ROM |
| [EAA] effective aperture angle | +/- 2.5 ° at 3 m |
| Emission | IR LED ($\lambda = 950$ nm) |
| [Us] rated supply voltage | 24 V DC (+/- 20 %) |
| Supply | Power supply must meet requirements of IEC 61496-1 Power supply must meet requirements of IEC 60204-1 |
| [Ie] rated operational current | 2 A |
| Current consumption | 42 mA no-load (transmitter) 83 mA no-load (receiver) 42 mA (transmitter) 900 mA with maximum load (receiver) |
| Output current limits | 0.4 A for safety outputs OSSD |
| Output voltage | 24 V |
| Output circuit type | DC |
| Voltage drop | ≤ 0.5 V |
| Local signalling | 1 multi-colour LED (transmitter) 2 dual colour LEDs (receiver) |
| Electrical connection | 1 male connector M12 5 pins (transmitter) 1 male connector M12 8 pins (receiver) |
| Function available | Test Muting through external safety module XPSLCMUT1160 LED display of operating modes and faults |
| Marking | CE |
| Material | Casing : aluminium Front panel: polycarbonate End caps: polypropylene |
| Housing colour | RAL 3000: red |
| Fixing mode | By fixing brackets |
| Product weight | 2.2 lb(US) (1 kg) |

Environment

| | |
|---------------------------------------|--|
| directives | 89/336/EEC - electromagnetic compatibility 2002/96/EC - WEEE directive 2002/95/EC - RoHS directive 98/37/EEC - machinery 89/655/EEC - work equipment |
| product certifications | CE CULus TÜV |
| safety level | SIL 3 conforming to IEC 61508 Type 4 conforming to IEC 61496-1 SILCL 3 conforming to IEC 62061 Category 4 conforming to EN/ISO 13849-1 PL = e conforming to EN/ISO 13849-1 |
| environmental characteristic | Resistance to light disturbance conforming to EN/IEC 61496-2 |
| service life | 20 yr |
| safety reliability data | PFHd = 9.47E-9 1/h conforming to IEC 61508 |
| ambient air temperature for operation | -22...131 °F (-30...55 °C) 14...131 °F |
| ambient air temperature for storage | -31...158 °F (-35...70 °C) -13...158 °F |
| relative humidity | 0...95 % without condensation |
| IP degree of protection | IP65 IP67 |
| shock resistance | 10 gn 16 ms conforming to IEC 61496-1 |
| vibration resistance | 0.35 +/- 0.05 mm (f = 10...55 Hz) conforming to IEC 61496-1 |

Offer Sustainability

| | |
|--|--|
| Green Premium product | Green Premium product |
| Compliant - since 1425 - Schneider Electric declaration of conformity | Compliant - since 1425 - Schneider Electric declaration of conformity |
| Reference not containing SVHC above the threshold | Reference not containing SVHC above the threshold |
| Available | Available |
| Available | Available |
| WARNING: This product can expose you to chemicals including: | WARNING: This product can expose you to chemicals including: |
| Diisononyl phthalate (DINP), which is known to the State of California to cause cancer, and | Diisononyl phthalate (DINP), which is known to the State of California to cause cancer, and |
| Di-isodecyl phthalate (DIDP), which is known to the State of California to cause birth defects or other reproductive harm. | Di-isodecyl phthalate (DIDP), which is known to the State of California to cause birth defects or other reproductive harm. |
| For more information go to www.p65warnings.ca.gov | For more information go to www.p65warnings.ca.gov |

Dimensions

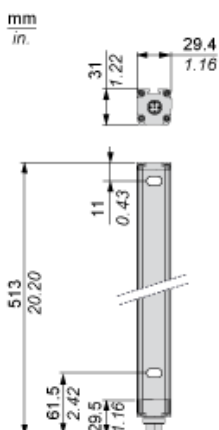

Brackets Dimensions



Mounting and Clearance

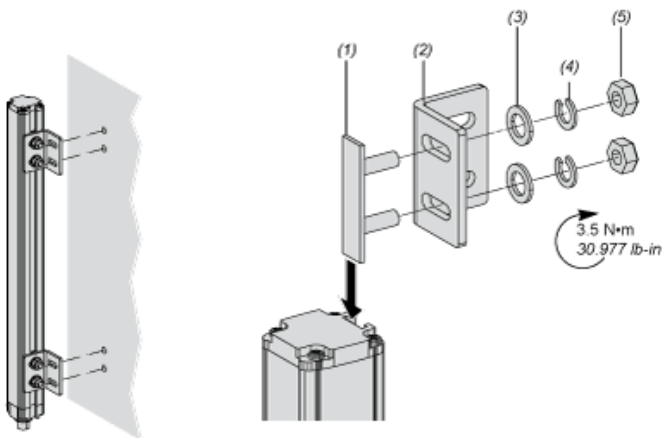

- (1) Insert
- (2) Bracket
- (3) Washer
- (4) Spring washer
- (5) Nut

Wiring Diagrams

Transmitter Connections



- (1) +24 Vdc
- (2) Configuration_0
- (3) 0 Vdc
- (4) Configuration_1
- (5) FE

Transmitter configurations and operating modes

| | High range option | Low range option | Transmitter in Test state | Forbidden wiring |
|-------------------------|-------------------|------------------|---------------------------|------------------|
| Pin 4 : Configuration_1 | 24 V | 0 V | 0 V | 24 V |
| Pin 2 : Configuration_0 | 0 V | 24 V | 0 V | 24 V |

Receiver Connections



- (1) OSSD1
- (2) + 24 V
- (3) OSSD2
- (4) Configuration_A
- (5) K1_K2 Feedback/Restart
- (6) Configuration_B
- (7) 0 Vdc
- (8) FE

Receiver Configurations and Operating Modes

Automatic Start/Restart

Without External Device Monitoring (EDM) feedback loop



With External Device Monitoring (EDM) feedback loop



Manual Start/Restart

Without External Device Monitoring (EDM) feedback loop



- (1) Restart

With External Device Monitoring (EDM) feedback loop



(1) Restart

Connecting to a Safety Interface

1 : Click on Download & Documents

2 : Click on Application solutions

To have all connection schematics concerning our safety module, select "download and document" and download the file "Safety light curtains association with safety interfaces"

Компания «Life Electronics» занимается поставками электронных компонентов импортного и отечественного производства от производителей и со складов крупных дистрибьюторов Европы, Америки и Азии.

С конца 2013 года компания активно расширяет линейку поставок компонентов по направлению коаксиальный кабель, кварцевые генераторы и конденсаторы (керамические, пленочные, электролитические), за счёт заключения дистрибьюторских договоров

Мы предлагаем:

- Конкурентоспособные цены и скидки постоянным клиентам.
- Специальные условия для постоянных клиентов.
- Подбор аналогов.
- Поставку компонентов в любых объемах, удовлетворяющих вашим потребностям.
- Приемлемые сроки поставки, возможна ускоренная поставка.
- Доставку товара в любую точку России и стран СНГ.
- Комплексную поставку.
- Работу по проектам и поставку образцов.
- Формирование склада под заказчика.
- Сертификаты соответствия на поставляемую продукцию (по желанию клиента).
- Тестирование поставляемой продукции.
- Поставку компонентов, требующих военную и космическую приемку.
- Входной контроль качества.
- Наличие сертификата ISO.

В составе нашей компании организован Конструкторский отдел, призванный помогать разработчикам, и инженерам.

Конструкторский отдел помогает осуществить:

- Регистрацию проекта у производителя компонентов.
- Техническую поддержку проекта.
- Защиту от снятия компонента с производства.
- Оценку стоимости проекта по компонентам.
- Изготовление тестовой платы монтаж и пусконаладочные работы.



Тел: +7 (812) 336 43 04 (многоканальный)

Email: org@lifeelectronics.ru