

Coupled Inductors MSD1514

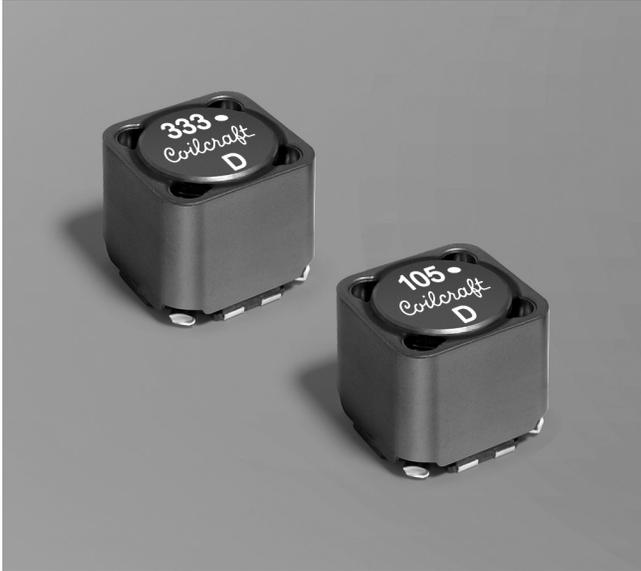

Core material Ferrite

Core and winding loss [Go to online calculator](#)

Environmental RoHS compliant, halogen free

Terminations RoHS compliant matte tin over nickel over phos bronze. Other terminations available at additional cost.

Weight: 9.0 – 11.8 g

Ambient temperature -40°C to $+85^{\circ}\text{C}$ with (40°C rise) Irms current.

Maximum part temperature $+125^{\circ}\text{C}$ (ambient + temp rise).

Storage temperature Component: -40°C to $+125^{\circ}\text{C}$.

Tape and reel packaging: -40°C to $+80^{\circ}\text{C}$

Winding-to-winding isolation 500 Vrms, one minute

Resistance to soldering heat Max three 40 second reflows at $+260^{\circ}\text{C}$, parts cooled to room temperature between cycles

Moisture Sensitivity Level (MSL) 1 (unlimited floor life at $<30^{\circ}\text{C}$ / 85% relative humidity)

Failures in Time (FIT) / Mean Time Between Failures (MTBF)

38 per billion hours / 26,315,789 hours, calculated per Telcordia SR-332

Packaging 175/13" reel; Plastic tape: 32 mm wide, 0.5 mm thick, 24 mm pocket spacing, 14.3 mm pocket depth

PCB washing Tested with pure water or alcohol only. For other solvents, see [Doc787_PCB_Washing.pdf](#).

- Excellent coupling coefficient ($k \geq 0.97$)
- Ideal for use in a variety of circuits including flyback, multi-output buck, SEPIC, Zeta, and Ćuk.
- High inductance, high efficiency and excellent current handling.
- In SEPIC topologies, the required inductance for each winding is half the value needed for two separate inductors, allowing selection of a part with lower DCR and higher current handling.

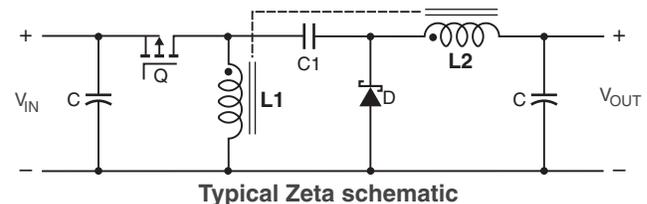
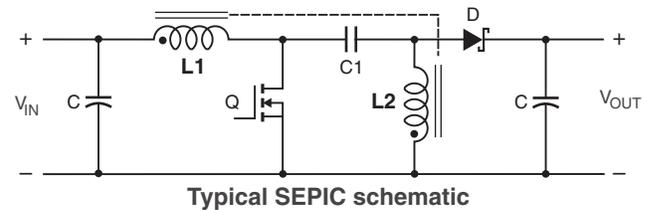
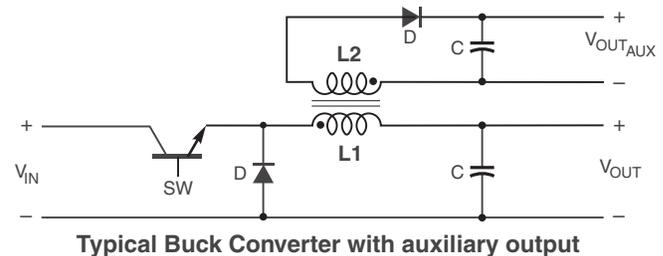
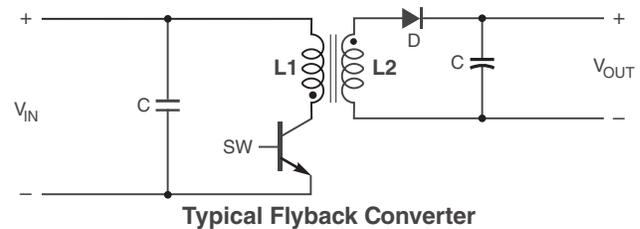



MSD1514 Coupled Inductors

Part number ¹	Inductance ² (μ H)	DCR (Ohms) ³		SRF typ ⁴ (MHz)	Coupling coefficient typ	Leakage inductance typ (μ H)	Isat (A) ⁵			Irms (A)	
		typ	max				10% drop	20% drop	30% drop	both windings ⁶	one winding ⁷
MSD1514-252ME_	2.5 \pm 20%	0.010	0.012	34.0	0.97	0.20	25.0	28.0	30.5	5.1	7.8
MSD1514-472ME_	4.7 \pm 20%	0.012	0.014	25.0	0.98	0.20	19.5	21.8	23.7	4.5	7.6
MSD1514-103ME_	10 \pm 20%	0.015	0.018	16.5	0.99	0.40	13.4	15.0	16.2	4.0	6.8
MSD1514-123ME_	12 \pm 20%	0.018	0.022	14.5	0.99	0.40	12.2	13.7	14.8	3.7	6.6
MSD1514-153ME_	15 \pm 20%	0.024	0.028	11.0	>0.99	0.42	10.9	12.2	13.3	3.4	5.8
MSD1514-223ME_	22 \pm 20%	0.031	0.036	10.0	>0.99	0.45	9.00	10.1	11.0	3.0	5.1
MSD1514-273ME_	27 \pm 20%	0.034	0.039	8.50	>0.99	0.45	8.14	9.13	9.90	2.95	4.7
MSD1514-333ME_	33 \pm 20%	0.045	0.052	7.20	>0.99	0.45	7.40	8.20	9.00	2.55	3.9
MSD1514-473ME_	47 \pm 20%	0.065	0.075	5.60	>0.99	0.55	6.20	6.90	7.50	2.20	3.45
MSD1514-683ME_	68 \pm 20%	0.078	0.090	5.20	>0.99	0.55	5.10	5.70	6.20	2.00	3.20
MSD1514-104KE_	100 \pm 10%	0.115	0.126	3.80	>0.99	0.55	4.20	4.75	5.15	1.65	2.50
MSD1514-224KE_	220 \pm 10%	0.261	0.287	2.30	>0.99	0.70	2.85	3.20	3.50	1.10	1.70
MSD1514-334KE_	330 \pm 10%	0.334	0.367	2.10	>0.99	0.80	2.33	2.61	2.83	0.98	1.55
MSD1514-474KE_	470 \pm 10%	0.500	0.550	1.65	>0.99	1.2	1.95	2.20	2.40	0.77	1.30
MSD1514-105KE_	1000 \pm 10%	1.12	1.25	1.10	>0.99	2.0	1.34	1.50	1.63	0.55	0.77

1. When ordering, please specify **termination** and **packaging** codes:

MSD1514-105KED

Termination: E = RoHS compliant matte tin over nickel over phos bronze.
Special order: Q = RoHS tin-silver-copper (95.5/4/0.5)
or P = non-RoHS tin-lead (63/37).

Packaging: D = 13" machine-ready reel. EIA-481 embossed plastic tape (175 parts per full reel).

B = Less than full reel. In tape, but not machine ready.
To have a leader and trailer added (\$25 charge),
use code letter D instead.

- Inductance shown for each winding, measured at 100 kHz, 0.1 Vrms, 0 Adc on an Agilent/HP 4284A LCR meter or equivalent. When leads are connected in parallel, inductance is the same value. When leads are connected in series, inductance is four times the value.
- DCR is for each winding. When leads are connected in parallel, DCR is half the value. When leads are connected in series, DCR is twice the value.
- SRF measured using an Agilent/HP 4191A or equivalent. When leads are connected in parallel, SRF is the same value.
- DC current at which the inductance drops the specified amount from its value without current. It is the sum of the current flowing in both windings.
- Equal current when applied to each winding simultaneously that causes a 40°C temperature rise from 25°C ambient.
[Click for temperature derating information.](#)
- Maximum current when applied to one winding that causes a 40°C temperature rise from 25°C ambient. This information is for reference only and does not represent absolute maximum ratings.
[Click for temperature derating information.](#)
- Electrical specifications at 25°C.
Refer to Doc 639 "Selecting Coupled Inductors for SEPIC Applications."
Refer to Doc 362 "Soldering Surface Mount Components" before soldering.

Coupled Inductor Core and Winding Loss Calculator

This web-based utility allows you to enter frequency, peak-to-peak (ripple) current, and Irms current to predict temperature rise and overall losses, including core loss. [Go to online calculator.](#)



MSD1514 Coupled Inductors

Typical L vs Current

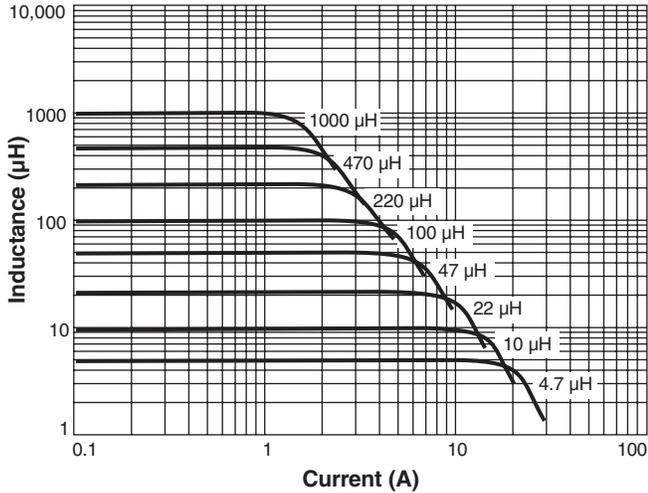

Typical L vs Frequency

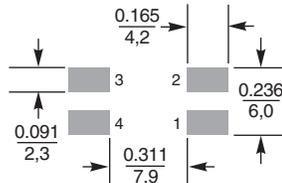
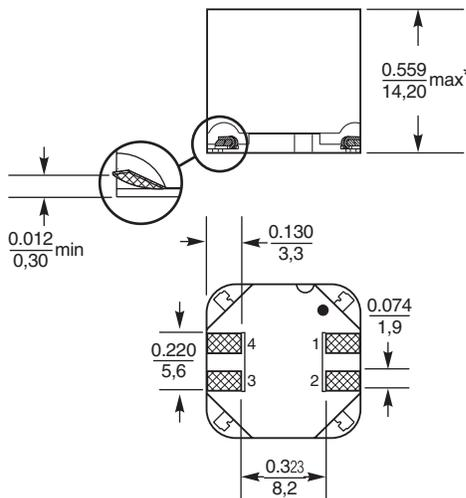
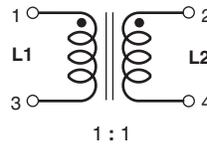
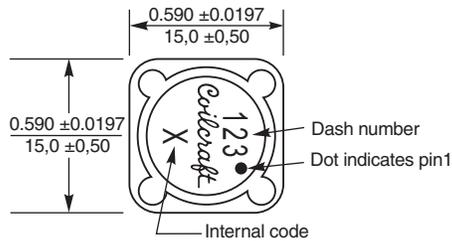
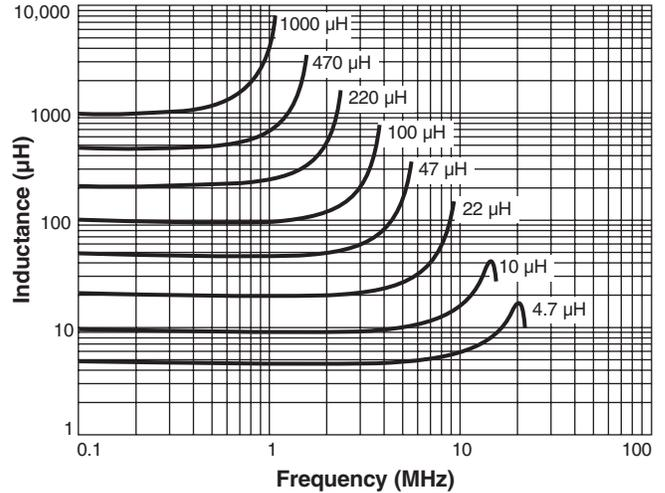

Recommended Land Pattern

* For optional tin-lead and tin-silver-copper terminations, dimensions are for the mounted part. Dimensions before mounting can be an additional 0.012 inch (0,3 mm).

Dimensions are in $\frac{\text{inches}}{\text{mm}}$



US +1-847-639-6400 sales@coilcraft.com
UK +44-1236-730595 sales@coilcraft-europe.com
Taiwan +886-2-2264 3646 sales@coilcraft.com.tw
China +86-21-6218 8074 sales@coilcraft.com.cn
Singapore + 65-6484 8412 sales@coilcraft.com.sg

Document 1308-3 Revised 05/06/16
 © Coilcraft Inc. 2018
 This product may not be used in medical or high risk applications without prior Coilcraft approval. Specification subject to change without notice. Please check web site for latest information.

Компания «Life Electronics» занимается поставками электронных компонентов импортного и отечественного производства от производителей и со складов крупных дистрибьюторов Европы, Америки и Азии.

С конца 2013 года компания активно расширяет линейку поставок компонентов по направлению коаксиальный кабель, кварцевые генераторы и конденсаторы (керамические, пленочные, электролитические), за счёт заключения дистрибьюторских договоров

Мы предлагаем:

- Конкуренспособные цены и скидки постоянным клиентам.
- Специальные условия для постоянных клиентов.
- Подбор аналогов.
- Поставку компонентов в любых объемах, удовлетворяющих вашим потребностям.
- Приемлемые сроки поставки, возможна ускоренная поставка.
- Доставку товара в любую точку России и стран СНГ.
- Комплексную поставку.
- Работу по проектам и поставку образцов.
- Формирование склада под заказчика.
- Сертификаты соответствия на поставляемую продукцию (по желанию клиента).
- Тестирование поставляемой продукции.
- Поставку компонентов, требующих военную и космическую приемку.
- Входной контроль качества.
- Наличие сертификата ISO.

В составе нашей компании организован Конструкторский отдел, призванный помогать разработчикам, и инженерам.

Конструкторский отдел помогает осуществить:

- Регистрацию проекта у производителя компонентов.
- Техническую поддержку проекта.
- Защиту от снятия компонента с производства.
- Оценку стоимости проекта по компонентам.
- Изготовление тестовой платы монтаж и пусконаладочные работы.



Тел: +7 (812) 336 43 04 (многоканальный)

Email: org@lifeelectronics.ru