

## CODE 88 - TINEL-LOCK BACKSHELL



**TXR88AB00-0905AI-**

SERIES \_\_\_\_\_  
 TXR: RING INCLUDED  
 (SEE RING OPTION)  
 TX: RING NOT INCLUDED  
 CONNECTOR INTERFACE \_\_\_\_\_  
 MATERIAL \_\_\_\_\_  
 REFER TO CH00-0250-008  
 FINISH \_\_\_\_\_  
 REFER TO CH00-0250-008  
 ANGLE \_\_\_\_\_  
 DASH NUMBER (TABLE 1) \_\_\_\_\_  
 ENTRY SIZE (TABLE 2) \_\_\_\_\_  
 RING OPTION \_\_\_\_\_  
 AI - TO SUIT SINGLE BRAID  
 BI - TO SUIT DOUBLE BRAID  
 FOR TX, LEAVE BLANK  
 MODIFICATION CODE \_\_\_\_\_  
 REFER TO CH00-0250-008 ②

### NOTES:

- THIS PRODUCT IS DESIGNED TO TERMINATE A BRAIDED CABLE SHIELD AND A HEAT SHRINKABLE LIPPED BOOT TO A CONNECTOR.
- ② FOR ADDITIONAL DIMENSIONS, ORDERING INFORMATION AND MODIFICATIONS, SEE CH00-0250-008.
- ③ SEE DRAWING TR FOR DETAIL ON TINEL-LOCK RING, RINGS ARE DESIGNED TO BE HEATED ELECTRICALLY, ALL RINGS ARE MARKED WITH THERMOCHROMIC PAINT WHICH CHANGES COLOUR WHEN INSTALLATION TEMPERATURE IS REACHED.
- BACKSHELL TO BE PERMANENTLY MARKED/BAGGED AND LABELLED WITH CODE IDENTIFICATION NUMBER AND PART NUMBER LESS RING DESIGNATOR. (e.g. 06090-TXR88AB00-0905). RING SHALL BEAR NO MARKING.
- BACKSHELL MATES TO: GLENAIR SERIES 800, 801, 803, 804 & 805 CONNECTORS.

If this document is printed it becomes uncontrolled. Check for the latest revision

DRAWN	K.WINCZURA	DATE 25/02/2015	 3RD ANGLE PROJECTION NOT TO SCALE	TITLE:	TINEL-LOCK BACKSHELL	 Polanco 
CHECKED		25/02/2015				
APPROVED	K.SHEPPARD	26/03/2015		UNLESS OTHERWISE SPECIFIED ALL DIMENSIONS IN MILLIMETRES GENERAL TOL LINEAR +/-0.25MM ANGULAR +/- 1°		
APPROVED	K.SMITH	20/08/2015				
REVISIONS						
LTR	DESCRIPTION	DATE	APPROVED			
D	REVISED PER ECO-12-021276	05/12/2012	SH			
E	REVISED PER ECO-15-011999	20/08/2015	K.SMITH			
TE CAGE CODE: 06090 POLAMCO/TE CAGE CODE: U5792				TE CONNECTIVITY - POLAMCO LTD RESERVES THE RIGHT TO AMEND THIS DRAWING AND THE INFORMATION SET FORTH HEREON AT ANY TIME. USERS SHOULD INDEPENDENTLY EVALUATE THE SUITABILITY OF THE PRODUCT FOR THEIR APPLICATION.		DRAWING NO: <b>TXR88</b>
				DRAWING REV:		<b>E</b>
				SHT		<b>1</b>

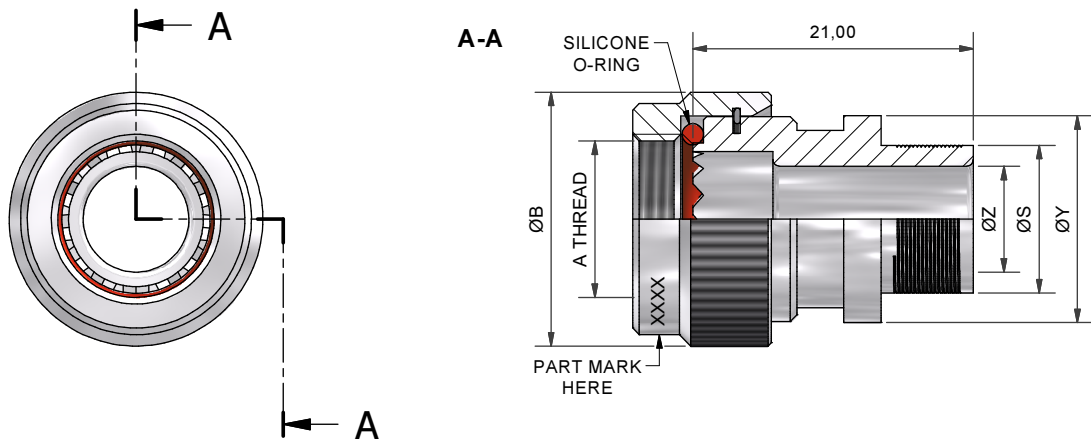





TABLE 1

ORDER NUMBER	SERIES 800	SERIES 801	SERIES 802	SERIES 803 & 804	SERIES 805	MAX ENTRY	A THREAD	ØB MAX
05	05	05	05	05	-	03	1/4-32UNEF	13,0
06	06	06	06	06	-	04	5/16-32UNEF	14,7
07	07	07	07	07	09	04	7-16-28UNEF	18,0
08	-	-	-	-	08	04	3/8-32UNEF	15,7
09	08	08	08	08	10	06	1/2-28UNEF	19,0
10	09	09	09	09	11	06	9/16-24UNEF	21,2
11	10	10	10	10	12	08	5/8-24UNEF	22,0
12	12	13	12	12	-	08	11/16-24UNEF	25,5
13	-	-	-	-	15	08	3/4-20UNEF	25,5
14	-	-	14	-	-	10	7/8-20UNEF	28,0
15	-	16-17	15	14-15	18-19	12	15/16-20UNEF	34,3

TABLE 2

ENTRY SIZE	ØZ +0,13/-0	ØS	ØY +/-0,3
03	4,75	7,36 +/-0,03	10,60
04	6,35	9,49 +/-0,04	14,00
05	7,92	11,06 +/-0,04	15,50
06	9,53	12,66 +/-0,04	17,10
07	11,10	14,21 +/-0,07	18,70
08	12,70	15,81 +/-0,07	20,30
10	15,88	18,96 +/-0,08	23,50
12	19,05	22,14 +/-0,08	26,70

If this document is printed it becomes uncontrolled. Check for the latest revision

DRAWN	K.WINCZURA	DATE 25/02/2015	 3RD ANGLE PROJECTION NOT TO SCALE	<b>TITLE:</b>  <b>TINEL-LOCK BACKSHELL</b>	 <b>Polamco</b> 											
CHECKED		25/02/2015	UNLESS OTHERWISE SPECIFIED ALL DIMENSIONS IN MILLIMETRES GENERAL TOL LINEAR +/-0,25MM ANGULAR +/- 1°	<b>ASSY USED ON:</b>  <b>MIGHTY MOUSE 800-805 SERIES</b>												
APPROVED	K.SHEPPARD	26/03/2015		<b>REVISIONS</b>												
APPROVED	K.SMITH	20/08/2015	<table border="1" style="width: 100%; border-collapse: collapse;"> <thead> <tr> <th>LTR</th> <th>DESCRIPTION</th> <th>DATE</th> <th>APPROVED</th> </tr> </thead> <tbody> <tr> <td>D</td> <td>REVISED PER ECO-12-021276</td> <td>05/12/2012</td> <td>SH</td> </tr> <tr> <td>E</td> <td>REVISED PER ECO-15-011999</td> <td>20/08/2015</td> <td>K.SMITH</td> </tr> </tbody> </table>	LTR	DESCRIPTION	DATE	APPROVED	D	REVISED PER ECO-12-021276	05/12/2012	SH	E	REVISED PER ECO-15-011999	20/08/2015	K.SMITH	
LTR	DESCRIPTION	DATE	APPROVED													
D	REVISED PER ECO-12-021276	05/12/2012	SH													
E	REVISED PER ECO-15-011999	20/08/2015	K.SMITH													
TE CAGE CODE: 06090 POLAMCO/TE CAGE CODE: U5792				TE CONNECTIVITY - POLAMCO LTD RESERVES THE RIGHT TO AMEND THIS DRAWING AND THE INFORMATION SET FORTH HEREON AT ANY TIME. USERS SHOULD INDEPENDENTLY EVALUATE THE SUITABILITY OF THE PRODUCT FOR THEIR APPLICATION.	DRAWING NO: <b>TXR88</b>											
				DRAWING REV: <b>E</b>	SHT <b>2</b>											

Компания «Life Electronics» занимается поставками электронных компонентов импортного и отечественного производства от производителей и со складов крупных дистрибьюторов Европы, Америки и Азии.

С конца 2013 года компания активно расширяет линейку поставок компонентов по направлению коаксиальный кабель, кварцевые генераторы и конденсаторы (керамические, пленочные, электролитические), за счёт заключения дистрибьюторских договоров

Мы предлагаем:

- Конкуренспособные цены и скидки постоянным клиентам.
- Специальные условия для постоянных клиентов.
- Подбор аналогов.
- Поставку компонентов в любых объемах, удовлетворяющих вашим потребностям.
- Приемлемые сроки поставки, возможна ускоренная поставка.
- Доставку товара в любую точку России и стран СНГ.
- Комплексную поставку.
- Работу по проектам и поставку образцов.
- Формирование склада под заказчика.
- Сертификаты соответствия на поставляемую продукцию (по желанию клиента).
- Тестирование поставляемой продукции.
- Поставку компонентов, требующих военную и космическую приемку.
- Входной контроль качества.
- Наличие сертификата ISO.

В составе нашей компании организован Конструкторский отдел, призванный помогать разработчикам, и инженерам.

Конструкторский отдел помогает осуществить:

- Регистрацию проекта у производителя компонентов.
- Техническую поддержку проекта.
- Защиту от снятия компонента с производства.
- Оценку стоимости проекта по компонентам.
- Изготовление тестовой платы монтаж и пусконаладочные работы.



Тел: +7 (812) 336 43 04 (многоканальный)

Email: [org@lifeelectronics.ru](mailto:org@lifeelectronics.ru)