

# PTFB091507FH

## Thermally-Enhanced High Power RF LDMOS FET 160 W, 28 V, 920 – 960 MHz

### Description

The PTFB091507FH is an LDMOS FET intended for use in multi-standard cellular power amplifier applications in the 920 to 960 MHz frequency band. Features include input and output matching, high gain and thermally-enhanced package with earless flange. Manufactured with Wolfspeed's advanced LDMOS process, this device provides excellent thermal performance and superior reliability.

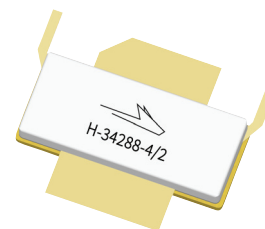

PTFB091507FH  
Package H-34288-4/2

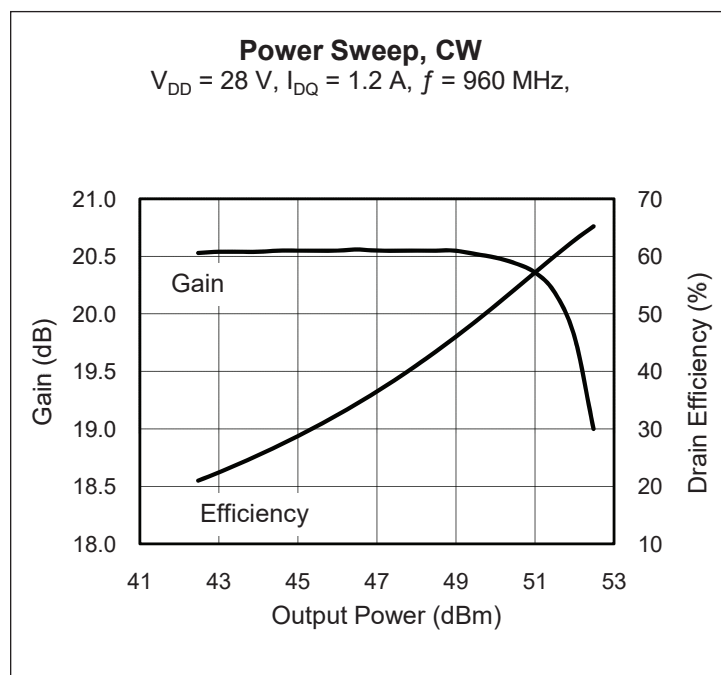

### Features

- Broadband internal matching
- Wide video bandwidth
- Typical CW performance, 960 MHz, 28 V
  - Average output power = 160 W
  - Gain = 19.5 dB
  - Efficiency = 60%
- Integrated ESD protection
- Low thermal resistance
- Thermally enhanced package is Pb-free and RoHS compliant
- Capable of handling 10:1 VSWR @ 28 V, 160 W (CW) output power

### RF Characteristics

**Single-carrier WCDMA Specifications** (not subject to production test; verified by design/characterization in Wolfspeed test fixture)

$V_{DD} = 28\text{ V}$ ,  $I_{DQ} = 1.2\text{ A}$ ,  $P_{OUT} = 50\text{ W}$  average

$f = 960\text{ MHz}$ , 3GPP signal, channel bandwidth = 3.84 MHz, PAR = 7.5 dB @ 0.01% CCDF probability

Characteristic	Symbol	Min	Typ	Max	Unit
Gain	Gps	—	20	—	dB
Drain Efficiency	$\eta_D$	—	38	—	%
Adjacent Channel Power Ratio	ACPR	—	-36	—	dBc

All published data at  $T_{CASE} = 25^\circ\text{C}$  unless otherwise indicated

ESD: Electrostatic discharge sensitive device—observe handling precautions!

**RF Characteristics** (cont.)**Two-tone Measurements** (tested in WolfSpeed test fixture)
 $V_{DD} = 28\text{ V}$ ,  $I_{DQ} = 1.2\text{ A}$ ,  $P_{OUT} = 70\text{ W avg}$ ,  $f = 960\text{ MHz}$ , tone spacing = 1 MHz

Characteristic	Symbol	Min	Typ	Max	Unit
Gain	Gps	19.5	20	—	dB
Drain Efficiency	$\eta_D$	43.5	45	—	%
Intermodulation Distortion	IMD	—	-30	-28	dBc

**DC Characteristics**

Characteristic	Conditions	Symbol	Min	Typ	Max	Unit
Drain-Source Breakdown Voltage	$V_{GS} = 0\text{ V}$ , $I_{DS} = 10\text{ mA}$	$V_{(BR)DSS}$	65	—	—	V
Drain Leakage Current	$V_{DS} = 28\text{ V}$ , $V_{GS} = 0\text{ V}$	$I_{DSS}$	—	—	1.0	$\mu\text{A}$
	$V_{DS} = 63\text{ V}$ , $V_{GS} = 0\text{ V}$		—	—	1.0	$\mu\text{A}$
On-State Resistance	$V_{GS} = 10\text{ V}$ , $V_{DS} = 0.1\text{ V}$	$R_{DS(on)}$	—	0.05	—	$\Omega$
Operating Gate Voltage	$V_{DS} = 28\text{ V}$ , $I_{DQ} = 1.2\text{ A}$	$V_{GS}$	2.5	3.9	4.5	V
Gate Leakage Current	$V_{GS} = 10\text{ V}$ , $V_{DS} = 0\text{ V}$	$I_{GSS}$	—	—	1.0	$\mu\text{A}$

**Maximum Ratings**

Parameter	Symbol	Value	Unit
Drain-Source Voltage	$V_{DSS}$	65	V
Gate-Source Voltage	$V_{GS}$	-6 to +10	V
Junction Temperature	$T_J$	200	$^{\circ}\text{C}$
Storage Temperature Range	$T_{STG}$	-40 to +150	$^{\circ}\text{C}$
Thermal Resistance ( $T_{CASE} = 70^{\circ}\text{C}$ )	$R_{\theta JC}$	0.31	$^{\circ}\text{C/W}$

**Ordering Information**

Type and Version	Order Code	Package Description	Shipping
PTFB091507FH V1 R0	PTFB091507FH-V1-R0	H-34288-4/2, earless flange	Tape & Reel, 50 pcs
PTFB091507FH V1 R250	PTFB091507FH-V1-R250	H-34288-4/2, earless flange	Tape & Reel, 250 pcs

**Typical Performance** (data taken in Wolfspeed test fixture)

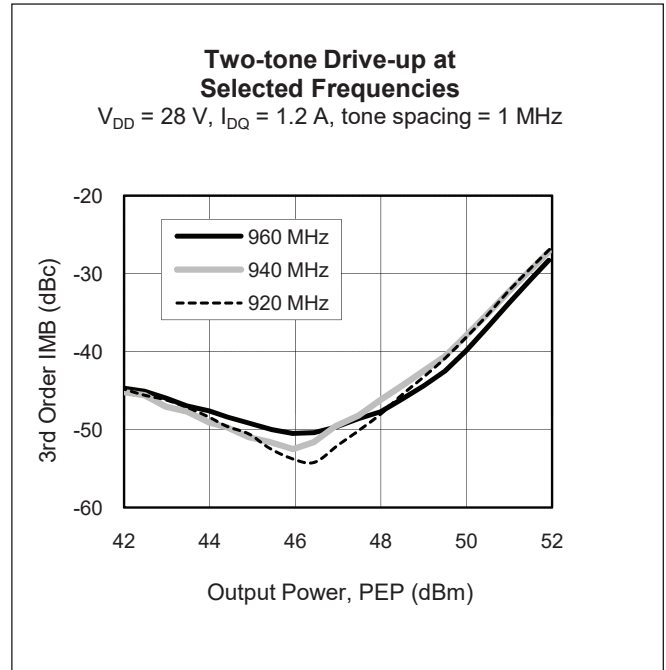
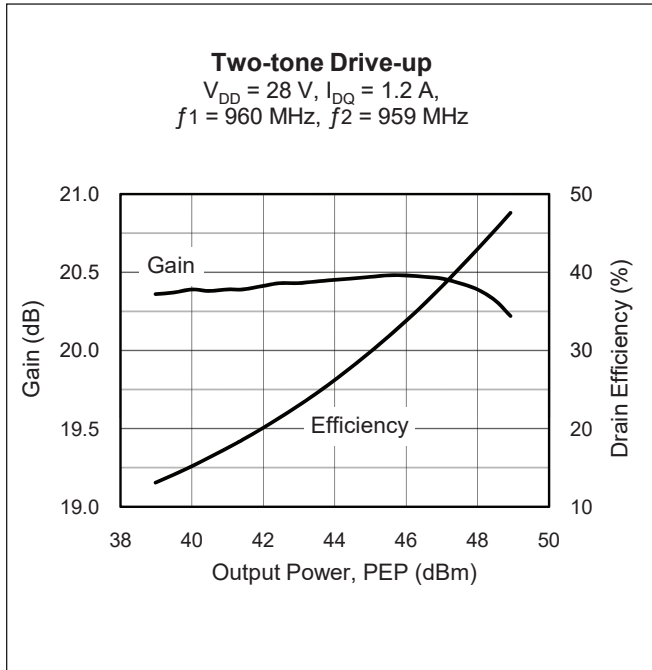
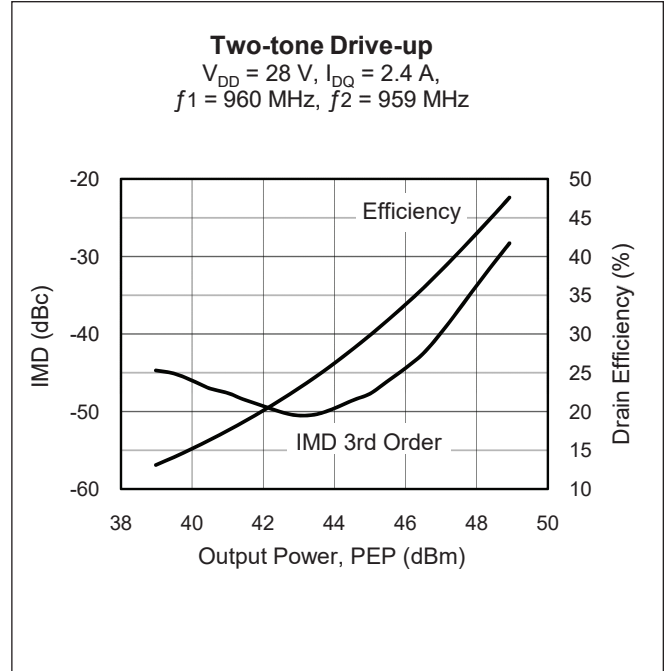
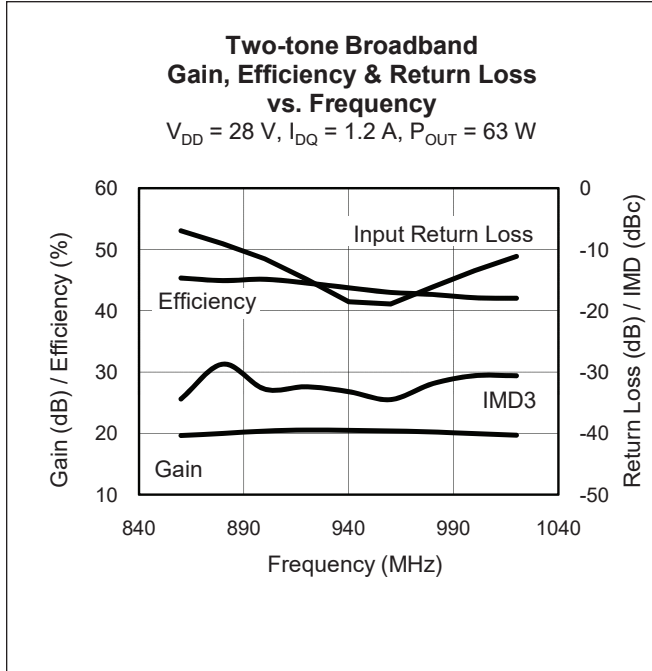



**Typical Performance (cont.)**

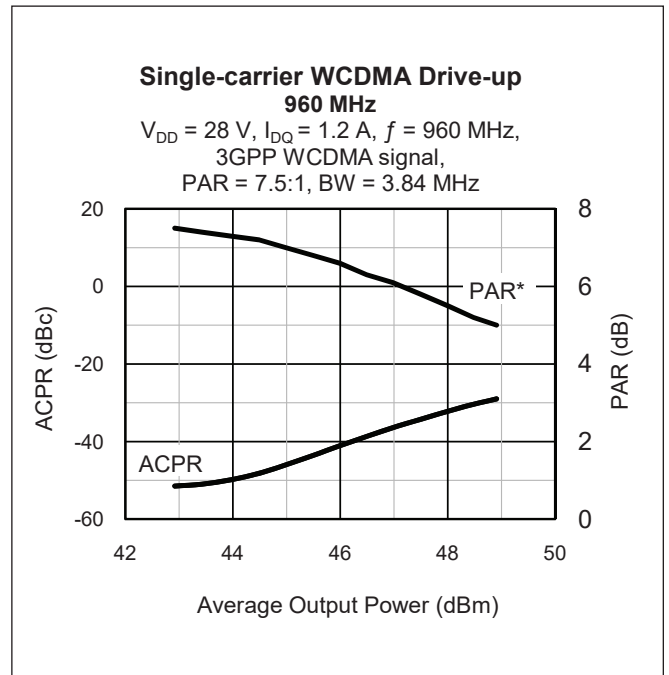
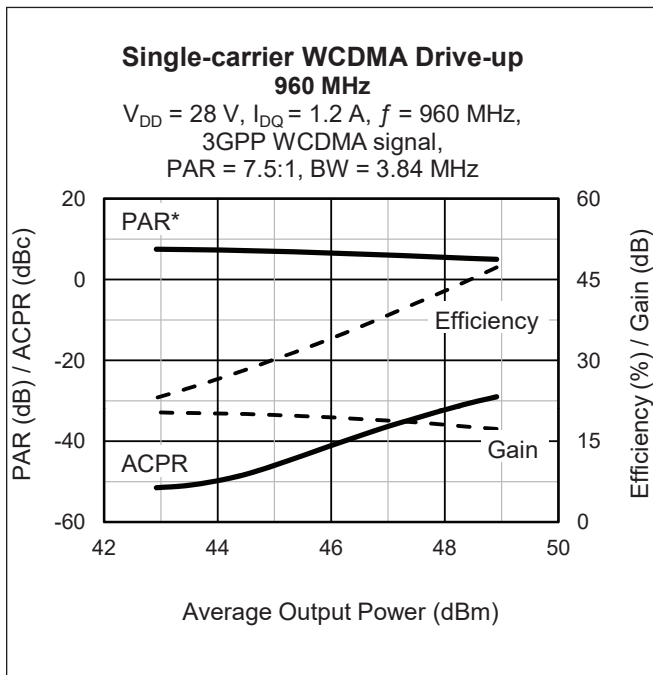
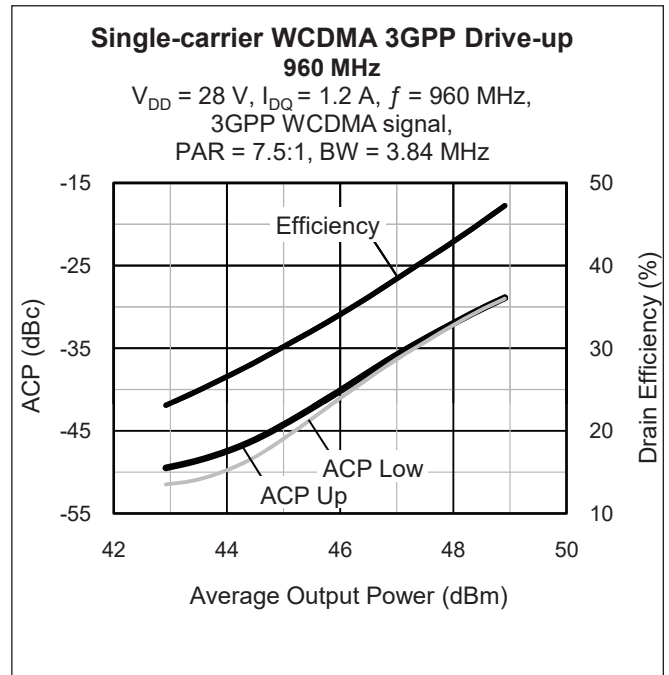
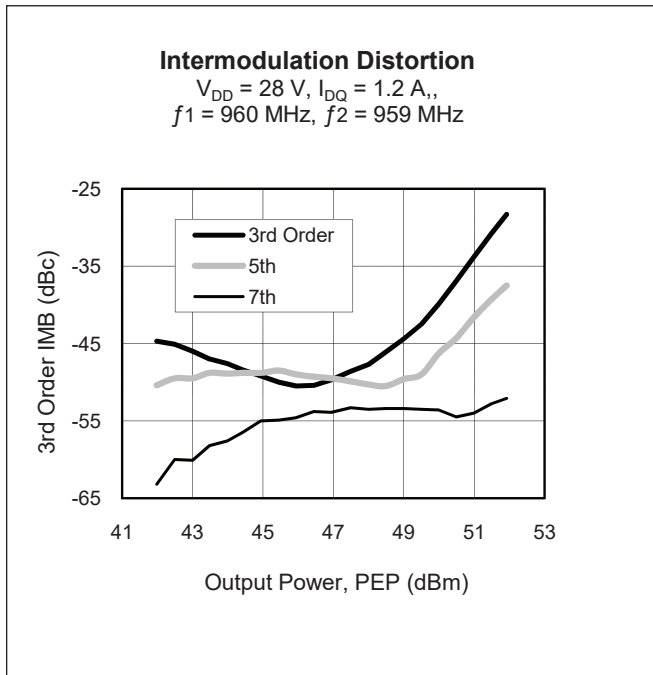

\*Peak-to-average ratio (PAR) compression at 0.01% probability on CCDF curve

Typical Performance (cont.)

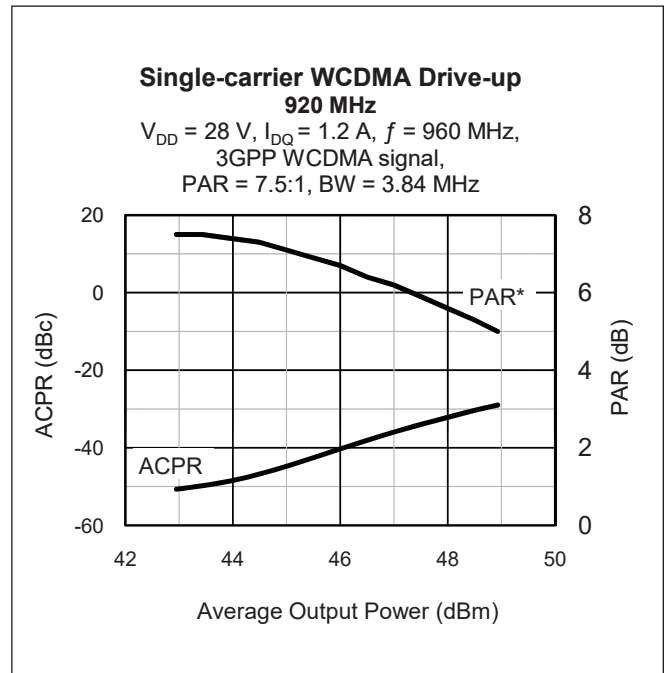
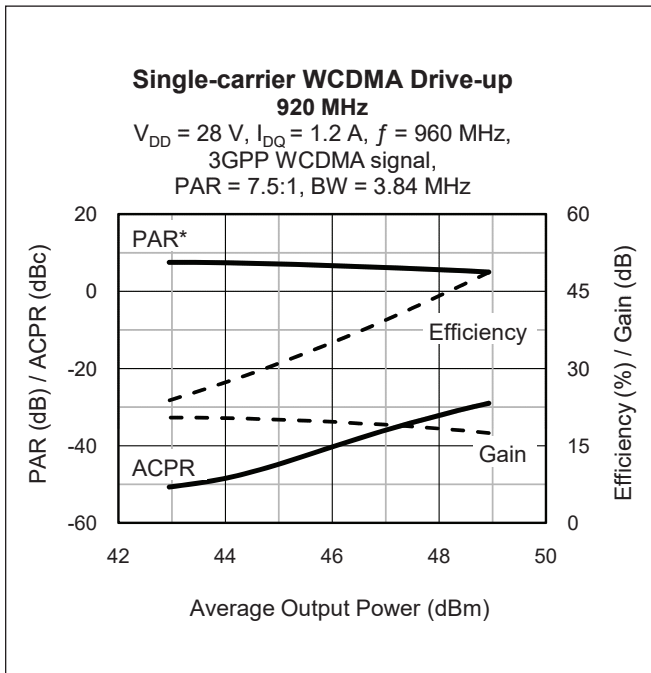
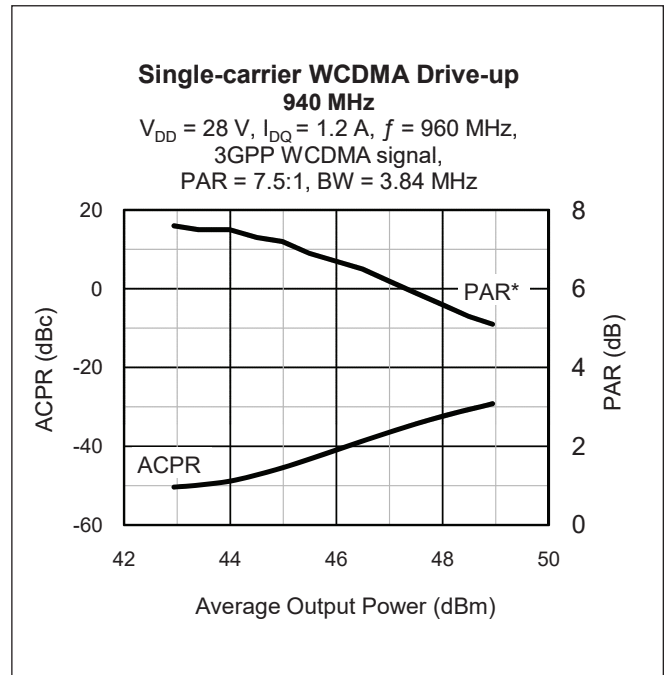
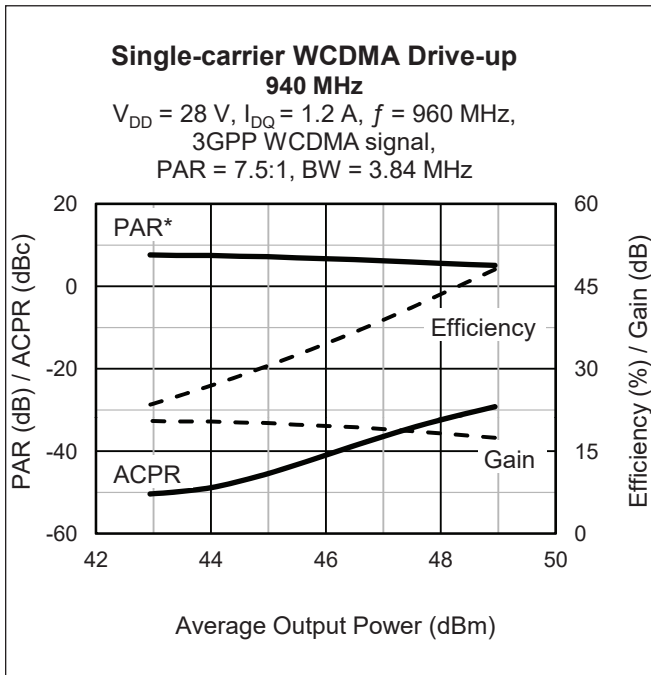

\*Peak-to-average ratio (PAR) compression at 0.01% probability on CCDF curve

## Broadband Circuit Impedance

Frequency MHz	Z source (W)		Z Load (W)	
	R	jX	R	jX
910	2.23	-3.12	1.53	-0.87
920	2.23	-3.03	1.52	-0.84
930	2.23	-2.95	1.50	-0.81
940	2.24	-2.87	1.49	-0.77
950	2.25	-2.80	1.46	-0.74
960	2.26	-2.73	1.44	-0.71
970	2.27	-2.65	1.42	-0.67

See next page for Reference Circuit information

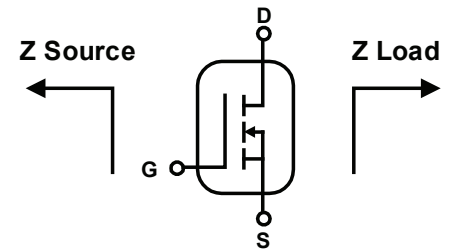

Reference Circuit

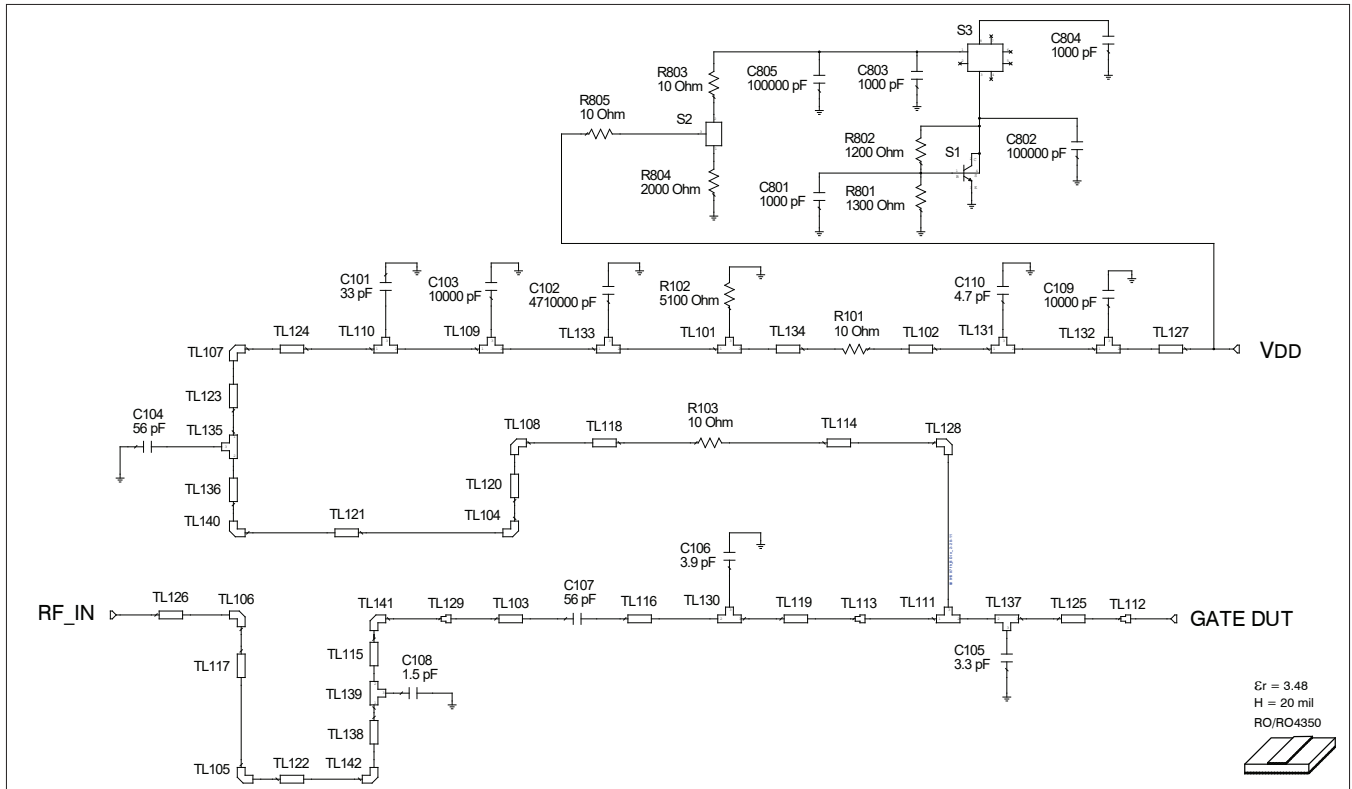

Reference circuit input schematic for  $f = 960$  MHz

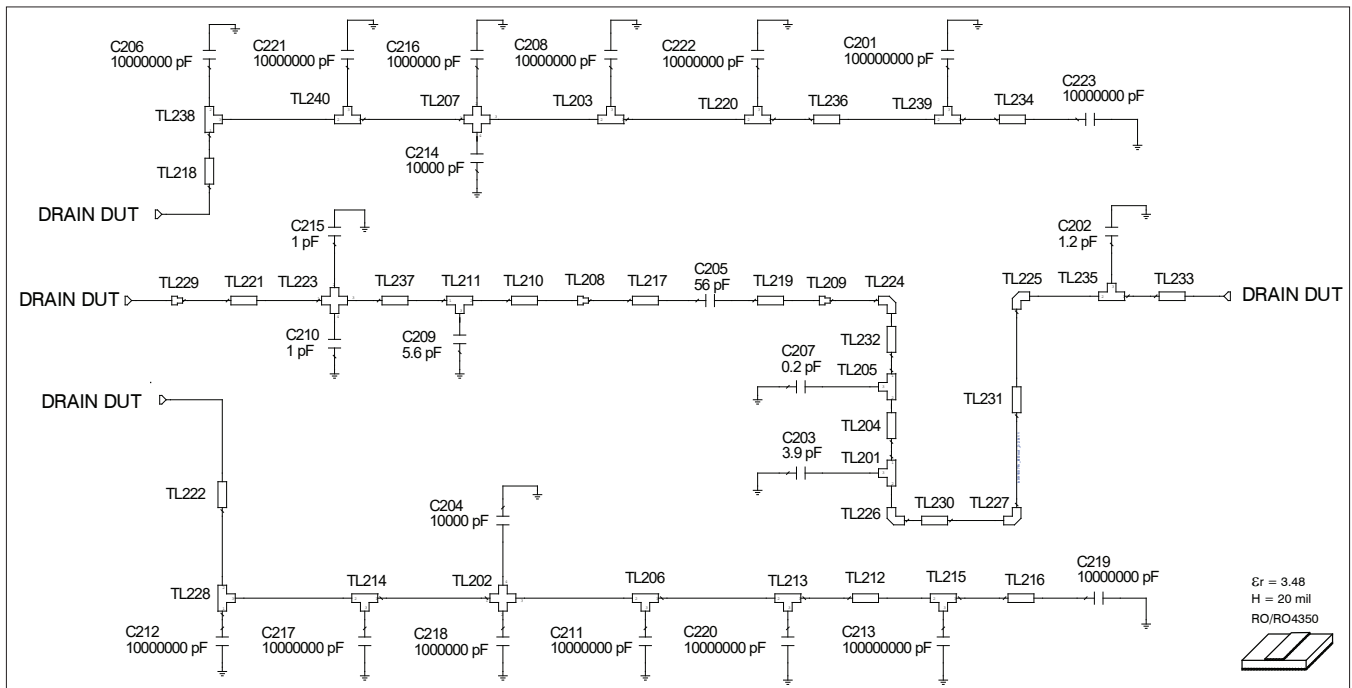

Reference circuit output schematic for  $f = 960$  MHz

**Reference Circuit** (cont.)

DUT	PTFB091507FH
Test Fixture Part No.	LTN/PTFB091507FH
PCB	Rogers RO4350, 0.508 mm [0.020"] thick, 2 oz. copper, $\epsilon_r = 3.48$
Gerber Files	Find Gerber files for this test fixture on the Wolfspeed Web site at <a href="http://www.wolfspeed.com/RF">www.wolfspeed.com/RF</a>

**ELectrical Characteristics at 960 MHz**

Microstrip	Characteristics	Dimensions: mm	Dimensions: mils
TL102	0.004 $\lambda$ , 26.8 $\Omega$	W = 2.79, L = 0.76	W = 110, L = 30
TL103	0.007 $\lambda$ , 39.1 $\Omega$	W = 1.68, L = 1.27	W = 66, L = 50
TL111	0.004 $\lambda$ , 5.3 $\Omega$	W1 = 17.78, W2 = 17.78, W3 = 0.76	W1 = 700, W2 = 700, W3 = 30
TL114	0.003 $\lambda$ , 63.9 $\Omega$	W = 0.76, L = 0.51	W = 30, L = 20
TL115	0.026 $\lambda$ , 51.5 $\Omega$	W = 1.10, L = 4.88	W = 44, L = 192
TL116	0.036 $\lambda$ , 39.1 $\Omega$	W = 1.68, L = 6.74	W = 66, L = 266
TL117	0.042 $\lambda$ , 51.5 $\Omega$	W = 1.10, L = 8.00	W = 44, L = 315
TL118	0.007 $\lambda$ , 63.9 $\Omega$	W = 0.76, L = 1.27	W = 30, L = 50
TL119	0.035 $\lambda$ , 39.1 $\Omega$	W = 1.68, L = 6.49	W = 66, L = 256
TL120	0.015 $\lambda$ , 63.9 $\Omega$	W = 0.76, L = 2.92	W = 30, L = 115
TL121	0.100 $\lambda$ , 63.9 $\Omega$	W = 0.76, L = 19.05	W = 30, L = 750
TL122	0.005 $\lambda$ , 51.5 $\Omega$	W = 1.10, L = 1.02	W = 44, L = 40
TL123	0.008 $\lambda$ , 63.9 $\Omega$	W = 0.76, L = 1.52	W = 30, L = 60
TL124	0.006 $\lambda$ , 26.8 $\Omega$	W = 2.79, L = 1.04	W = 110, L = 41
TL125	0.102 $\lambda$ , 5.3 $\Omega$	W = 17.78, L = 17.55	W = 700, L = 691
TL126	0.040 $\lambda$ , 51.5 $\Omega$	W = 1.10, L = 7.57	W = 44, L = 298
TL127	0.004 $\lambda$ , 26.8 $\Omega$	W = 2.79, L = 0.76	W = 110, L = 30
TL130	0.011 $\lambda$ , 39.1 $\Omega$	W1 = 1.68, W2 = 1.68, W3 = 2.03	W1 = 66, W2 = 66, W3 = 80
TL134	0.007 $\lambda$ , 26.8 $\Omega$	W = 2.79, L = 1.19	W = 110, L = 47
TL136	0.008 $\lambda$ , 63.9 $\Omega$	W = 0.76, L = 1.52	W = 30, L = 60
TL137	0.016 $\lambda$ , 5.3 $\Omega$	W1 = 17.78, W2 = 17.78, W3 = 2.79	W1 = 700, W2 = 700, W3 = 110
TL138	0.002 $\lambda$ , 51.5 $\Omega$	W = 1.10, L = 0.33	W = 44, L = 13
TL139	0.015 $\lambda$ , 51.5 $\Omega$	W1 = 1.10, W2 = 1.10, W3 = 2.79	W1 = 44, W2 = 44, W3 = 110
TL201	0.004 $\lambda$ , 51.5 $\Omega$	W1 = 1.10, W2 = 1.10, W3 = 0.76	W1 = 44, W2 = 44, W3 = 30
TL202, 207	0.010 $\lambda$ , 20.9 $\Omega$	W1 = 3.81, W2 = 1.83, W3 = 3.81, W4 = 1.83	W1 = 150, W2 = 72, W3 = 150, W4 = 72
TL203	0.016 $\lambda$ , 20.9 $\Omega$	W1 = 3.81, W2 = 3.81, W3 = 2.79	W1 = 150, W2 = 150, W3 = 110
TL204	0.014 $\lambda$ , 51.5 $\Omega$	W = 1.10, L = 2.67	W = 44, L = 105
TL205	0.015 $\lambda$ , 51.5 $\Omega$	W1 = 1.10, W2 = 1.10, W3 = 2.79	W1 = 44, W2 = 44, W3 = 110
TL206	0.016 $\lambda$ , 20.9 $\Omega$	W1 = 3.81, W2 = 3.81, W3 = 2.79	W1 = 150, W2 = 150, W3 = 110
TL210	0.109 $\lambda$ , 5.7 $\Omega$	W = 16.51, L = 18.62	W = 650, L = 733
TL211	0.016 $\lambda$ , 5.7 $\Omega$	W1 = 16.51, W2 = 16.51, W3 = 2.79	W1 = 650, W2 = 650, W3 = 110
TL212	0.014 $\lambda$ , 20.9 $\Omega$	W = 3.81, L = 2.51	W = 150, L = 99
TL213	0.016 $\lambda$ , 20.9 $\Omega$	W1 = 3.81, W2 = 3.81, W3 = 2.79	W1 = 150, W2 = 150, W3 = 110
TL214	0.007 $\lambda$ , 20.9 $\Omega$	W1 = 3.81, W2 = 3.81, W3 = 1.27	W1 = 150, W2 = 150, W3 = 50

*table continued on next page*



**Reference Circuit** (cont.)

Microstrip	Characteristics	Dimensions: mm	Dimensions: mils
TL215	0.021 $\lambda$ , 20.9 $\Omega$	W1 = 3.81, W2 = 3.81, W3 = 3.81	W1 = 150, W2 = 150, W3 = 150
TL216	0.041 $\lambda$ , 20.9 $\Omega$	W = 3.81, L = 7.29	W = 150, L = 287
TL217	0.008 $\lambda$ , 39.1 $\Omega$	W = 1.68, L = 1.52	W = 66, L = 60
TL218	0.016 $\lambda$ , 16.5 $\Omega$	W = 5.08, L = 2.90	W = 200, L = 114
TL219	0.011 $\lambda$ , 39.1 $\Omega$	W = 1.68, L = 2.03	W = 66, L = 80
TL220	0.016 $\lambda$ , 20.9 $\Omega$	W1 = 3.81, W2 = 3.81, W3 = 2.79	W1 = 150, W2 = 150, W3 = 110
TL221	0.037 $\lambda$ , 5.7 $\Omega$	W = 16.51, L = 6.38	W = 650, L = 251
TL222	0.016 $\lambda$ , 16.5 $\Omega$	W = 5.08, L = 2.89	W = 200, L = 114
TL223	0.011 $\lambda$ , 5.7 $\Omega$	W1 = 16.51, W2 = 1.83, W3 = 16.51, W4 = 1.83	W1 = W1, W2 = 72, W3 = 650, W4 = 72
TL228	0.021 $\lambda$ , 16.5 $\Omega$	W1 = 5.08, W2 = 5.08, W3 = 3.81	W1 = 200, W2 = 200, W3 = 150
TL230	0.006 $\lambda$ , 51.5 $\Omega$	W = 1.10, L = 1.14	W = 44, L = 45
TL231	0.060 $\lambda$ , 51.5 $\Omega$	W = 1.10, L = 11.3	W = 44, L = 445
TL232	0.027 $\lambda$ , 51.5 $\Omega$	W = 1.10, L = 5.08	W = 44, L = 200
TL233	0.006 $\lambda$ , 51.5 $\Omega$	W = 1.10, L = 1.12	W = 44, L = 44
TL234	0.041 $\lambda$ , 20.9 $\Omega$	W = 3.81, L = 7.29	W = 150, L = 287
TL235	0.010 $\lambda$ , 51.5 $\Omega$	W1 = 1.10, W2 = 1.10, W3 = 1.91	W1 = 44, W2 = 44, W3 = 75
TL236	0.014 $\lambda$ , 20.9 $\Omega$	W = 3.81, L = 2.51	W = 150, L = 99
TL237	0.052 $\lambda$ , 5.7 $\Omega$	W = 16.51, L = 8.89	W = 650, L = 350
TL238	0.021 $\lambda$ , 16.5 $\Omega$	W1 = 5.08, W2 = 5.08, W3 = 3.81	W1 = 200, W2 = 200, W3 = 150
TL239	0.021 $\lambda$ , 20.9 $\Omega$	W1 = 3.81, W2 = 3.81, W3 = 3.81	W1 = 150, W2 = 150, W3 = 150
TL240	0.007 l, 20.9 W	W1 = 3.81, W2 = 3.81, W3 = 1.27	W1 = 150, W2 = 150, W3 = 50

Reference Circuit (cont.)

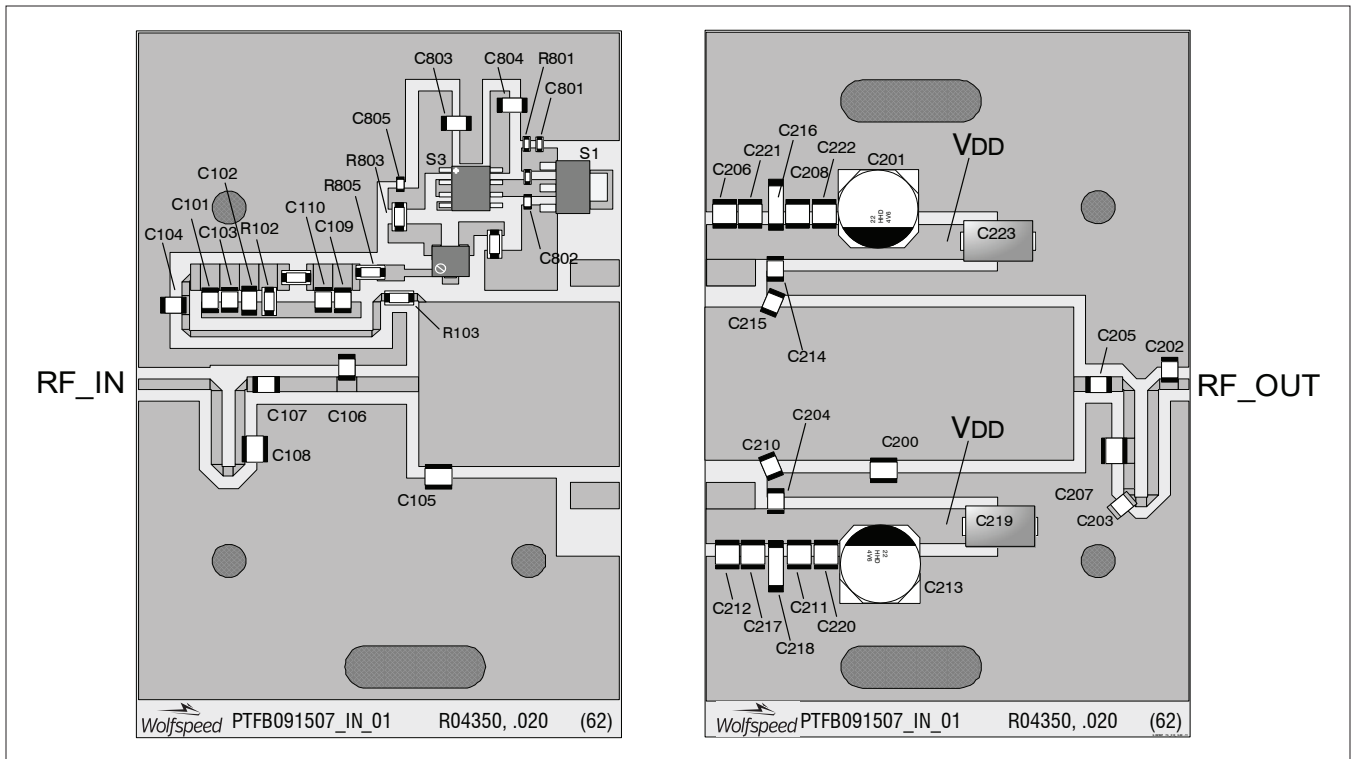

Reference circuit board layout (not to scale)

Component	Description	Suggested Supplier	P/N or Comment
C101	Chip capacitor, 33 pF	ATC	ATC100B330JW500XB
C102	Chip capacitor, 4.71 $\mu$ F	Digi-Key	493-2372-2-ND
C103	Capacitor, 10 nF	ATC	ATC200B103MW50XC
C104, C107	Chip capacitor, 56 pF	ATC	ATC100B560JW500XB
C105	Chip capacitor, 3.3 pF	ATC	ATC100B3R3CW500XB
C106, C203	Chip capacitor, 3.9 pF	ATC	ATC100B3R9CW500XB
C108	Chip capacitor, 1.5 pF	ATC	ATC100B1R5CW500XB
C109	Capacitor, 10 nF	ATC	ATC200B103MW50XC
C110	Chip capacitor, 4.7 pF	ATC	ATC100B4R7CW500XB
C201, C213	Electrolytic cap., 100 $\mu$ F, 50 V	Digi-Key	PCE4442TR-ND
C202	Chip capacitor, 1.2 pF	ATC	ATC100B1R2CW500XB
C204	Capacitor, 10 nF	ATC	ATC200B103MW50XC
C205	Chip capacitor, 56 pF	ATC	ATC100B560JW500XB
C206, C208, C211, C212, C217, C220, C221, C222	Capacitor, 10 $\mu$ F	Digi-Key	587-1818-2-ND
C207	Chip capacitor, 0.2 pF	ATC	ATC100B0R2CW500XB
C209	Chip capacitor, 5.6 pF	ATC	ATC100B5R6CW500XB
C210	Chip capacitor, 1 pF	ATC	ATC100B1R0CW500XB

table continued on next page

**Reference Circuit** (cont.)

<b>Component</b>	<b>Description</b>	<b>Suggested Supplier</b>	<b>P/N or Comment</b>
C214	Capacitor, 10 nF	ATC	ATC200B103MW50XC
C215	Chip capacitor, 1 pF	ATC	ATC100B1R0CW500XB
C216, C218	Chip capacitor, 1 $\mu$ F	Digi-Key	478-3993-2-ND
C219, C223	Tantalum capacitor, 10 $\mu$ F, 35 V	Garrett Electronics	281M5002106K
C801, C803, C804	Chip capacitor, 1 nF	Digi-Key	PCC1772CT-ND
C802, 805	Chip capacitor, 100 nF	Digi-Key	PCC104BCT-ND
R101	Resistor, 10 $\Omega$	Digi-Key	P10ECT-ND
R102	Resistor, 5.1 $\Omega$	Digi-Key	P5.1KECT-ND
R103	Resistor, 10 $\Omega$	Digi-Key	P10ECT-ND
R801	Resistor, 1.3k $\Omega$	Digi-Key	P1.3KGCT-ND
R802	Resistor, 1.2k $\Omega$	Digi-Key	P1.2KGCT-ND
R803, R805	Resistor, 10 $\Omega$	Digi-Key	P10ECT-ND
R804	Resistor, 2k $\Omega$	Digi-Key	P2.0KECT-ND
S1	Transistor	Digi-Key	BCP5616-ND
S2	Potentiometer, 2k $\Omega$	Digi-Key	3224W-202ECT-ND
S3	Voltage regulator	Digi-Key	LM78L05ACM-ND

**See package outline specifications on next page**

## Package Outline Specifications

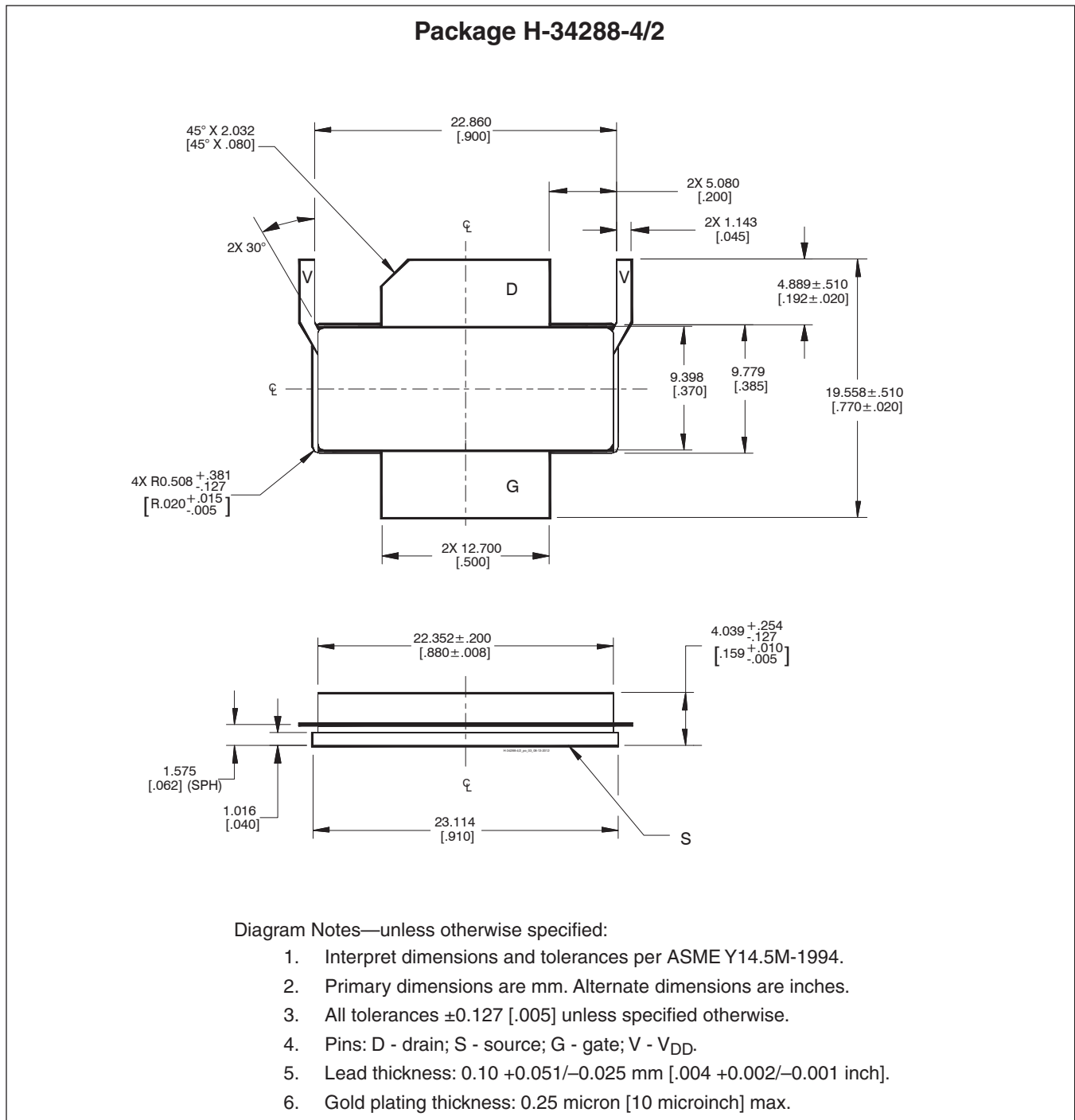

## Revision History

Revision	Date	Data Sheet Type	Page	Subjects (major changes at each revision)
03.1	2016-06-09	Production	2	Updated ordering code to R0
04	2018-06-22	Production	All	Converted to Wolfspeed Data Sheet

For more information, please contact:

4600 Silicon Drive  
 Durham, North Carolina, USA 27703  
[www.wolfspeed.com/RF](http://www.wolfspeed.com/RF)

Sales Contact  
[RFSales@wolfspeed.com](mailto:RFSales@wolfspeed.com)

RF Product Marketing Contact  
[RFMarketing@wolfspeed.com](mailto:RFMarketing@wolfspeed.com)  
 919.407.7816

## Notes

---

### Disclaimer

Specifications are subject to change without notice. Cree, Inc. believes the information contained within this data sheet to be accurate and reliable. However, no responsibility is assumed by Cree for any infringement of patents or other rights of third parties which may result from its use. No license is granted by implication or otherwise under any patent or patent rights of Cree. Cree makes no warranty, representation or guarantee regarding the suitability of its products for any particular purpose. "Typical" parameters are the average values expected by Cree in large quantities and are provided for information purposes only. These values can and do vary in different applications and actual performance can vary over time. All operating parameters should be validated by customer's technical experts for each application. Cree products are not designed, intended or authorized for use as components in applications intended for surgical implant into the body or to support or sustain life, in applications in which the failure of the Cree product could result in personal injury or death or in applications for planning, construction, maintenance or direct operation of a nuclear facility.

Компания «Life Electronics» занимается поставками электронных компонентов импортного и отечественного производства от производителей и со складов крупных дистрибьюторов Европы, Америки и Азии.

С конца 2013 года компания активно расширяет линейку поставок компонентов по направлению коаксиальный кабель, кварцевые генераторы и конденсаторы (керамические, пленочные, электролитические), за счёт заключения дистрибьюторских договоров

Мы предлагаем:

- Конкурентоспособные цены и скидки постоянным клиентам.
- Специальные условия для постоянных клиентов.
- Подбор аналогов.
- Поставку компонентов в любых объемах, удовлетворяющих вашим потребностям.
- Приемлемые сроки поставки, возможна ускоренная поставка.
- Доставку товара в любую точку России и стран СНГ.
- Комплексную поставку.
- Работу по проектам и поставку образцов.
- Формирование склада под заказчика.
- Сертификаты соответствия на поставляемую продукцию (по желанию клиента).
- Тестирование поставляемой продукции.
- Поставку компонентов, требующих военную и космическую приемку.
- Входной контроль качества.
- Наличие сертификата ISO.

В составе нашей компании организован Конструкторский отдел, призванный помогать разработчикам, и инженерам.

Конструкторский отдел помогает осуществить:

- Регистрацию проекта у производителя компонентов.
- Техническую поддержку проекта.
- Защиту от снятия компонента с производства.
- Оценку стоимости проекта по компонентам.
- Изготовление тестовой платы монтаж и пусконаладочные работы.



Тел: +7 (812) 336 43 04 (многоканальный)  
Email: [org@lifeelectronics.ru](mailto:org@lifeelectronics.ru)