



Features/Benefits

- Compact design
- Low actuation force
- Detect mechanical movement
- Left and right options
- Right angle options

Typical Applications

- Computer peripherals
- Office equipment
- Consumer electronics
- Appliances
- Audio and visual equipment

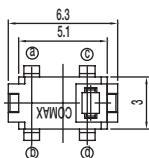

PART NUMBER	PACKAGING	SCHEMATIC
DS-02005	1,000 pieces	1P-1T

Specifications

CONTACT ARRANGEMENT: SPST, NO
 CONTACT RATING: 100mA @ 30 VDC
 OPERATING LIFE: 50,000 cycles
 OPERATING FORCE: 50 gf max.
 PRE-TRAVEL: 0.7 mm
 TOTAL TRAVEL: 2.6 mm
 INITIAL CONTACT RESISTANCE: 1 Ω max.
 INSULATION RESISTANCE: 100 M Ω min. @ 100 VDC 60 sec.
 DIELECTRIC STRENGTH: 100 V AC (50-60Hz) 60 sec.
 OPERATING TEMPERATURE: -40°C to +85°C.

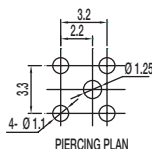
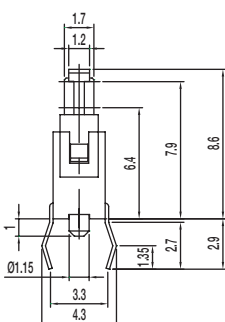
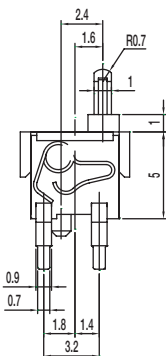

Materials

KNOB: PA
 COVER: PA
 SPRING: Gold plated, copper alloy
 HOUSING: PA
 TERMINAL: Silver plated, copper alloy

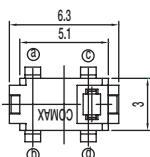

PART NUMBER	PACKAGING	SCHEMATIC
DS-02005 (30)	1,000 pieces	1P-1T

Specifications

CONTACT ARRANGEMENT: SPST, NO
 CONTACT RATING: 100mA @ 30 VDC
 OPERATING LIFE: 50,000 cycles
 OPERATING FORCE: 30 gf max.
 PRE-TRAVEL: 0.7 mm
 TOTAL TRAVEL: 2.2 mm
 INITIAL CONTACT RESISTANCE: 1 Ω max.
 INSULATION RESISTANCE: 100 M Ω min. @ 100 VDC 60 sec.
 DIELECTRIC STRENGTH: 100 V AC (50-60Hz) 60 sec.
 OPERATING TEMPERATURE: -40°C to +85°C.

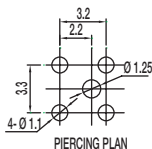
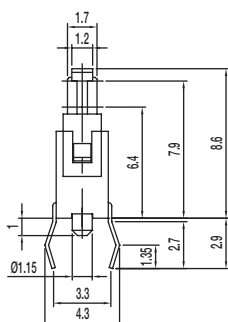
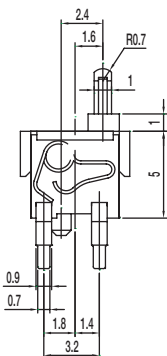

Materials

KNOB: PA
 COVER: PA
 SPRING: Gold plated, copper alloy
 HOUSING: PA
 TERMINAL: Silver plated, copper alloy

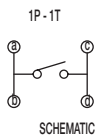

DS Series Detect Switch



PART NUMBER	PACKAGING	SCHEMATIC
DS-02005-A	1,000 pieces	1P-1T N.O.

Specifications

CONTACT ARRANGEMENT: SPST, NO
 CONTACT RATING: 100mA @ 30 VDC
 OPERATING LIFE: 50,000 cycles
 OPERATING FORCE: 50 gf max.
 PRE-TRAVEL: 0.7 mm
 TOTAL TRAVEL: 2.6 mm
 INITIAL CONTACT RESISTANCE: 1 Ω max.
 INSULATION RESISTANCE: 100 M Ω min. @ 100 VDC 60 sec.
 DIELECTRIC STRENGTH: 100 V AC (50-60Hz) 60 sec.
 OPERATING TEMPERATURE: -40°C to +85°C.

Materials

KNOB: PA
 COVER: PA
 SPRING: Gold plated, copper alloy
 HOUSING: PA
 TERMINAL: Silver plated, copper alloy



PART NUMBER	PACKAGING	SCHEMATIC
DS-21805	2,500 pieces	 N.O.

Specifications

CONTACT ARRANGEMENT: SPDT
 CONTACT RATING: 5mA @ 5 VDC
 OPERATING LIFE: 100,000 cycles
 OPERATING FORCE: 36 gf
 TOTAL TRAVEL: 2.20 mm
 INITIAL CONTACT RESISTANCE: 1 Ω max.
 INSULATION RESISTANCE: 100 M Ω min. @ 100 VDC 60 sec.
 DIELECTRIC STRENGTH: 100 V AC (50-60Hz) 60 sec.
 OPERATING TEMPERATURE: -20°C to +70°C.

Materials

KNOB: POM
 COVER: PA46
 SPRING: Silver plated
 HOUSING: PPS
 TERMINAL: Silver plated

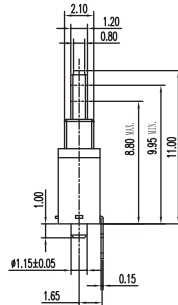
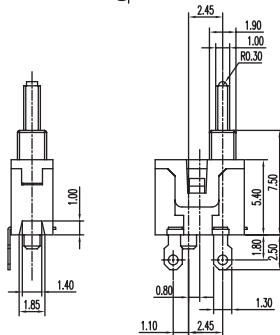
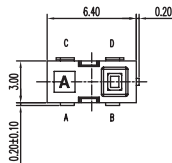

D

Detect



PART NUMBER	PACKAGING	SCHEMATIC
DS-09005-02 BK	500 pieces	

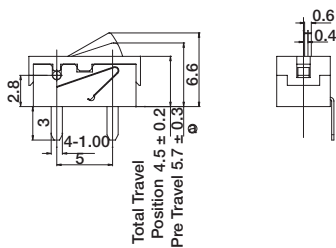

Specifications

CONTACT ARRANGEMENT: SPST
 CONTACT RATING: 1mA @ 5 VDC
 OPERATING LIFE: 100,000 cycles
 OPERATING FORCE: 50 gf max.
 TOTAL TRAVEL: 4.5±0.2 mm
 INITIAL CONTACT RESISTANCE: 500 m Ω max.
 INSULATION RESISTANCE: 100 M Ω min. @ 500 VDC 60 sec.
 DIELECTRIC STRENGTH: 500 V AC (50-60Hz) 60 sec.
 OPERATING TEMPERATURE: -20°C to +70°C.

Materials

LEVER: POM
 COVER: PA
 HOUSING: PA
 TERMINAL: Silver plated



PART NUMBER	PACKAGING	SCHEMATIC
DS-09005-02 RP	500 pieces	

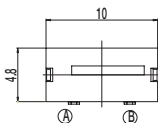

Specifications

CONTACT ARRANGEMENT: SPST
 CONTACT RATING: 1mA @ 5 VDC
 OPERATING LIFE: 100,000 cycles
 OPERATING FORCE: 50 gf max.
 TOTAL TRAVEL: 4.5±0.2 mm
 INITIAL CONTACT RESISTANCE: 500 m Ω max.
 INSULATION RESISTANCE: 100 M Ω min. @ 500 VDC 60 sec.
 DIELECTRIC STRENGTH: 500 V AC (50-60Hz) 60 sec.
 OPERATING TEMPERATURE: -20°C to +70°C.

Materials

LEVER: POM
 COVER: PA
 HOUSING: PA
 TERMINAL: Silver plated



Detect

Компания «Life Electronics» занимается поставками электронных компонентов импортного и отечественного производства от производителей и со складов крупных дистрибьюторов Европы, Америки и Азии.

С конца 2013 года компания активно расширяет линейку поставок компонентов по направлению коаксиальный кабель, кварцевые генераторы и конденсаторы (керамические, пленочные, электролитические), за счёт заключения дистрибьюторских договоров

Мы предлагаем:

- Конкурентоспособные цены и скидки постоянным клиентам.
- Специальные условия для постоянных клиентов.
- Подбор аналогов.
- Поставку компонентов в любых объемах, удовлетворяющих вашим потребностям.
- Приемлемые сроки поставки, возможна ускоренная поставка.
- Доставку товара в любую точку России и стран СНГ.
- Комплексную поставку.
- Работу по проектам и поставку образцов.
- Формирование склада под заказчика.
- Сертификаты соответствия на поставляемую продукцию (по желанию клиента).
- Тестирование поставляемой продукции.
- Поставку компонентов, требующих военную и космическую приемку.
- Входной контроль качества.
- Наличие сертификата ISO.

В составе нашей компании организован Конструкторский отдел, призванный помогать разработчикам, и инженерам.

Конструкторский отдел помогает осуществить:

- Регистрацию проекта у производителя компонентов.
- Техническую поддержку проекта.
- Защиту от снятия компонента с производства.
- Оценку стоимости проекта по компонентам.
- Изготовление тестовой платы монтаж и пусконаладочные работы.



Тел: +7 (812) 336 43 04 (многоканальный)

Email: org@lifeelectronics.ru