

CIRCUIT DESCRIPTION

In a typical pulse oximetry application, an LED is pulsed from a high level of current (for example, 3/4 scale) to a lower level of current (for example, 1/4 scale). The on-time of these pulses is typically in the order of several hundred microseconds. Peak-to-peak 1/f noise superimposed on the LED brightness levels during the on-time affects the accuracy of the overall measurement and must be minimized.

Figure 1 shows the single-supply signal chain that consists of a voltage reference, a DAC, a DAC output buffer, and a current source.

The DAC is the [AD5542A](#) 16-bit, serial input, voltage output segmented R-2R CMOS DAC. The output voltage of the DAC is dependent on the reference voltage, as shown in the following equation:

$$V_{OUT} = \frac{V_{REF} \times D}{2^N}$$

where:

D is the decimal data word loaded in the DAC register.

N is the number of bits.

For a reference of 2.5 V and $N = 16$, the equation simplifies to the following:

$$V_{OUT} = \frac{2.5 \times D}{2^{16}} = \frac{2.5 \times D}{65,536}$$

This gives a V_{OUT} of 1.25 V at mid scale, and 2.5 V at full scale.

The LSB size is $2.5 \text{ V}/65,536 = 38.1 \text{ } \mu\text{V}$.

One LSB at 16 bits is also 0.0015% of full scale or 15 ppm full scale.

The DAC reference pin is driven by an 2.5 V [ADR4525](#) voltage reference buffered with the [ADA4500-2](#). The [ADR4525](#) voltage reference provides a high precision, low noise (1.25 μV p-p, 0.1 Hz to 10 Hz), and stable reference to the DAC. The [ADR4525](#) uses an innovative core topology to achieve high accuracy while offering industry-leading temperature stability and noise performance. The low output voltage temperature coefficient (2 ppm/°C maximum) and low long-term output voltage drift of the device also improve system accuracy over time and temperature variations. The initial room temperature error of the [ADR4525B](#) is $\pm 0.02\%$ maximum, which is approximately 13 LSBs at 16 bits.

The dual [ADA4500-2](#) is selected as the DAC output buffer as well as the voltage reference buffer. The [ADA4500-2](#) is a high precision amplifier with maximum offset voltage of 120 μV , offset drift of less than 5.5 $\mu\text{V}/^\circ\text{C}$, 0.1 Hz to 10 Hz noise of 2 μV p-p, and maximum input bias current of 2 pA. Its innovative rail-to-rail input structure eliminates crossover distortion and therefore makes it an excellent choice as a DAC buffer.

A typical rail-to-rail input amplifier uses two differential pairs (PNP and NPN, or PMOS and NMOS) to achieve rail-to-rail input swing (see the [MT-035 Tutorial](#)). One differential pair is active at the low range of the input common-mode voltage, and the other pair is active at the high end. This classic complementary dual differential pair topology introduces crossover distortion during the transition between one differential pair to the other. The change in offset voltage causes nonlinearity when the amplifier is used as a DAC buffer.

The [ADA4500-2](#) uses an integrated charge pump in its input structure to achieve rail-to-rail input swing without the need for a second differential pair. Therefore, it does not exhibit crossover distortion. Using a zero crossover distortion amplifier in this single-supply system provides wide dynamic output range while maintaining linearity over the entire input common-mode range. Details of the operation of the [ADA4500-2](#) can be found in the [ADA4500-2](#) data sheet.

The output impedance of the DAC is constant (typically 6.25 k Ω) and code independent. The output buffer must therefore have a high input impedance and low input bias current to minimize errors. The [ADA4500-2](#) is a suitable candidate with high input impedance and 2 pA maximum of input bias current at room temperature, and 190 pA maximum of input bias current over temperature. This results in 1.2 μV worst-case error due to input bias current flowing through the 6.25 k Ω DAC impedance, which is significantly less than 1 LSB.

The output of the DAC is buffered and used to drive the power MOSFET (IRLMS2002TRPBF). The MOSFET converts the DAC output voltage into current that drives the LED. The MOSFET in the circuit is able to handle currents up to 6.5 A; however, the current is limited to 20 mA, which is the maximum rated current of the LED supplied on the [EVAL-CN0370-SDPZ](#) board. The board has provisions to easily change the full-scale current to the LED by changing the R_{LIMIT} resistor. The maximum current can be calculated by

$$I_{MAX} = 2.5 \text{ V}/R_{LIMIT}$$

Jumper options allow the LED to be connected to either the PMOD voltage (VPMOD) or an external voltage (VEXT).

The VEXT option is required to provide sufficient headroom for the MOSFET when operating with $V_{PMOD} = 3.3 \text{ V}$. For example, if $V_{OUT} = 2.5 \text{ V}$, $V_{DS} = 0.7 \text{ V}$, and $V_{LED} = 0.7 \text{ V}$, then VEXT must be greater than $2.5 \text{ V} + 0.7 \text{ V} + 0.7 \text{ V} = 3.9 \text{ V}$.

An alternative that allows 3.3 V supply operation is to limit the full-scale output voltage to approximately 1.9 V and only use 76% of the DAC output range. The R_{LIMIT} resistor must be changed to approximately 95 Ω to maintain 20 mA full-scale output current at 1.9 V output.

The [AD5542A](#) is available in a 10-lead MSOP or 10-lead LFCSP. The [ADR4525](#) is available in an 8-lead SOIC, and the [ADA4500-2](#) is available in an 8-lead MSOP or 8-lead LFCSP.

Integral Nonlinearity (INL) and Differential Nonlinearity (DNL) Measurements

INL is the deviation in LSB of the actual DAC transfer function from an idealized transfer function. DNL is the difference between an actual step size and the ideal value of 1 LSB. This system solution provides a 16-bit resolution with ± 1 LSB DNL and INL. Figure 2 and Figure 3 show the DNL and INL performance of the circuit.

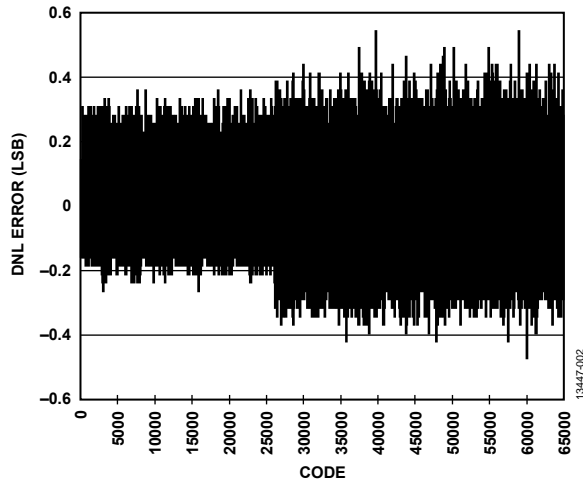

Figure 2. Differential Nonlinearity (DNL)

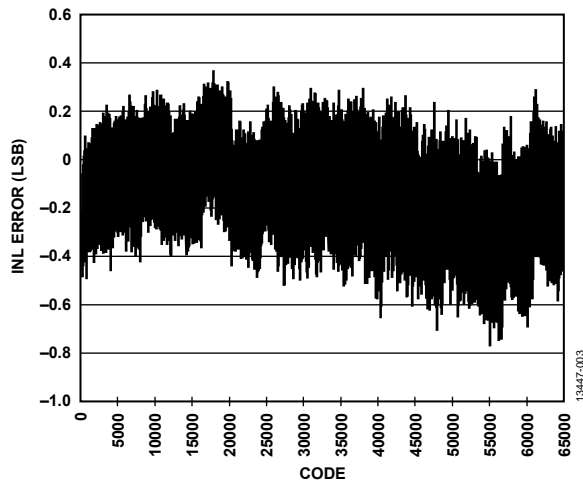

Figure 3. Integral Nonlinearity (INL)

Note that the DNL and INL measurements exclude the 100 codes (approximately 4 mV) from the lower end of the range. This is because the MOSFET leakage current causes the output voltage to become nonlinear in this region.

Figure 4 shows the nonlinearity introduced using an op amp with a traditional rail-to-rail input stage. This plot shows the crossover distortion when the active differential pair changes from the PNP pair to the NPN pair. The error swings from +4 LSB to -15 LSB in this region.

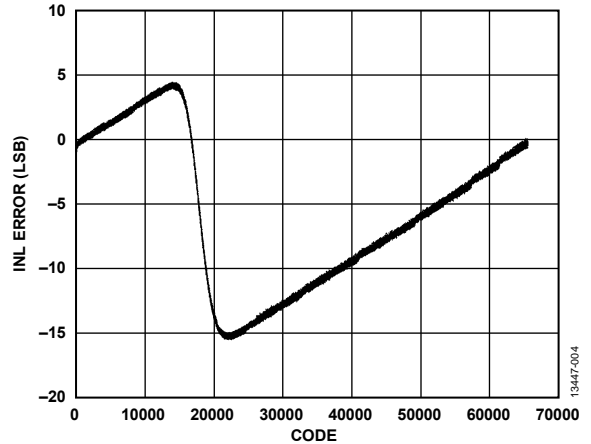

Figure 4. DAC Nonlinearity when Using Op Amp Buffer with Traditional Rail-to-Rail Input Stage

Noise Measurements

The targeted 0.1 Hz to 10 Hz noise for the complete system was less than 14 μ V p-p measured at V_{OUT} . The noise of the three components can be combined in a root-sum-squares (RSS) manner to estimate the total system noise. The 0.1 Hz to 10 Hz values are

- AD5542A: 0.134 μ V p-p
- ADR4525: 1.25 μ V p-p
- ADA4500-2 (reference buffer): 2 μ V p-p
- ADA4500-2 (DAC buffer): 2 μ V p-p

The RSS value of the above contributors is 3.1 μ V p-p.

The true noise of the circuit is measured by using a noise measuring box with a gain of 10,000 combined with a 0.1 Hz to 10 Hz filter. Figure 5 shows the noise test setup.

The EVAL-SDP-CB1Z System Development Platform (SDP) and SDP-PMD-IB1Z interposer boards were removed from the setup, and the supply was taken from a 4.5 V battery.

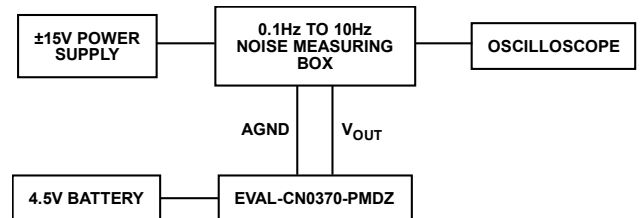

Figure 5. Test Setup for Measuring 0.1 Hz to 10 Hz Noise with Gain of 10,000

The noise output of the box with the input shorted and the noise with the circuit connected were measured and were 7.81 μ V p-p and 9.6 μ V p-p, respectively, as shown in Figure 6 and Figure 7. The noise of the two systems is uncorrelated and therefore combines in an RSS manner, and the system noise is calculated as follows:

$$\text{System Noise} = \sqrt{(9.6)^2 - (7.81)^2} = 5.58 \mu\text{V p-p}$$

The corresponding noise current driving the LED is 5.58 μ V \div 124 Ω = 45 nA for a full-scale current of 20 mA.

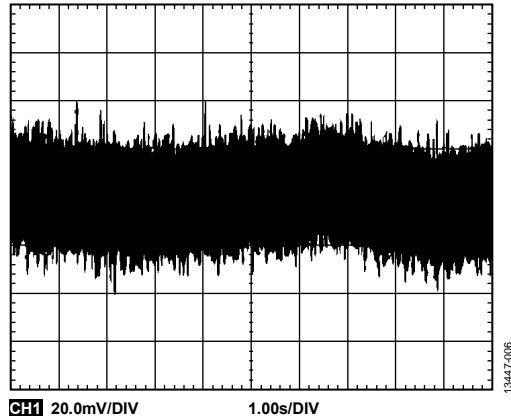

Figure 6. Output Noise with Input to Noise Measuring Box Shorted Measures 78.1 mV p-p (7.81 μ V p-p Referenced to Input)

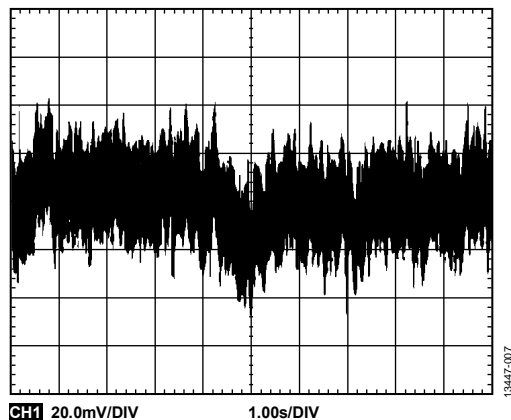

Figure 7. Output Noise with EVAL-CN0370-PMDZ Connected Measures 96 mV p-p (9.6 μ V p-p Referenced to Input)

Board Layout Considerations

It is important to carefully consider the power supply and ground return layout on the board. The printed circuit board must have separate analog and digital sections. If the circuit is used in a system where multiple devices require an analog ground to digital ground connection, make the connection at only one point. Power supplies to all components must be bypassed with at least 0.1 μ F capacitors. These bypass capacitors must be as physically close as possible to the device, with the capacitor ideally right up against the device. Choose the 0.1 μ F capacitor to have low effective series resistance (ESR) and low effective series inductance (ESL), such as ceramic capacitors. This 0.1 μ F capacitor provides a low impedance path to ground for transient currents. The power supply line must also have as large a trace as possible to provide a low impedance supply path. Use proper layout, grounding, and decoupling techniques to achieve optimum performance (see the [MT-031 Tutorial, Grounding Data Converters and Solving the Mystery of AGND and DGND](#) and the [MT-101 Tutorial, Decoupling Techniques](#)).

A complete design support package including layout files, schematics, and bill of materials, is available at www.analog.com/CN0370-DesignSupport.

COMMON VARIATIONS

For a lower power consumption solution (at lower speed), use the [ADA4505-1/ADA4505-2/ADA4505-4](#) as the output buffer. The [ADA4505-1/ADA4505-2/ADA4505-4](#) are micropower, zero crossover distortion amplifiers with low input bias current. The [ADR441](#) and [ADR421](#) are suitable candidates to provide the 2.5 V reference. They feature high accuracy, low noise and accept input voltages up to 18 V.

The [AD5063](#) is a 16-bit, unbuffered voltage output DAC that allows bipolar mode operation in a dual-supply application.

CIRCUIT EVALUATION AND TEST

This circuit uses the [EVAL-CN0370-PMDZ](#) circuit board and the [EVAL-SDP-CB1Z](#) SDP board with the [SDP-PMD-IB1Z](#) interposer board. The SDP board and the interposer boards have 120-pin mating connectors, allowing quick setup and evaluation of the circuit performance. The [EVAL-CN0370-PMDZ](#) board is connected via the PMOD connector J3. The [EVAL-CN0370-PMDZ](#) contains the circuit to be evaluated, as described in this circuit note. The SDP board and the interposer board are used with the [CN-0370 evaluation software](#) to capture the data from the [EVAL-CN0370-PMDZ](#) circuit board. The software user guide is available at www.analog.com/wiki-CN0370.

Equipment Needed

The following equipment is needed:

- PC with a USB port and Windows® XP, Windows Vista (32-bit), or Windows 7 (32-bit)
- [EVAL-CN0370-PMDZ](#) circuit evaluation board
- [EVAL-SDP-CB1Z](#) SDP board
- [SDP-PMD-IB1Z](#) interposer board
- [CN-0370 evaluation software](#) (download from <ftp://ftp.analog.com/pub/cftl/CN0370/>)
- Power supply: 6 V wall wart or [EVAL-CFTL-6V-PWRZ](#)
- Agilent 34401A multimeter or equivalent
- GPIB to USB cable (required only when making linearity measurements on the circuit)

Getting Started

Download the [CN-0370 evaluation software](#) and install it on the PC.

Functional Block Diagram

Figure 8 shows the functional block diagram of the test setup.

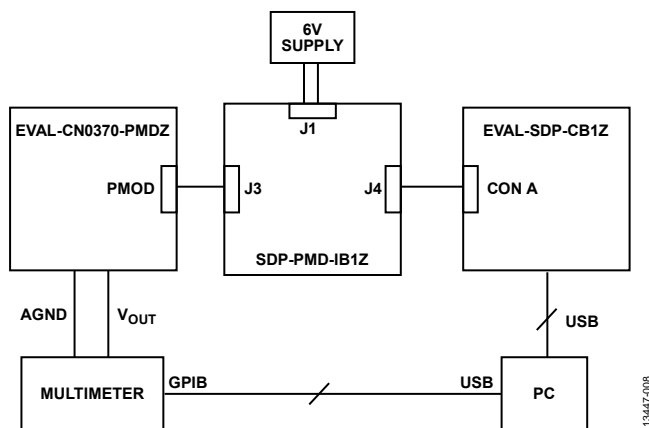

Figure 8. Test Setup Functional Block Diagram

Setup

Connect the 120-pin connector on the [SDP-PMD-IB1Z](#) interposer board to the connector marked CON A on the [EVAL-SDP-CB1Z](#) SDP board. Use nylon hardware to secure the two boards firmly, using the holes provided at the ends of the 120-pin connectors. Connect the [EVAL-CN0370-PMDZ](#) to the J3 PMOD connector.

With power to the supply off, connect a 6 V wall wart power supply to the J1 connector. Connect the USB cable supplied with the SDP board to the USB port on the PC. Do not connect the USB cable to the mini USB connector on the SDP board at this time.

Test

Apply power to the interposer board then connect the USB cable from the PC to the USB mini connector on the SDP board and launch the evaluation software. The software communicates with the [EVAL-CN0370-PMDZ](#) if the [EVAL-SDP-CB1Z](#) System Development Platform is listed in Windows **Device Manager**.

After USB communications are established, the SDP board can be used to write data to the [EVAL-CN0370-PMDZ](#) circuit evaluation board.

Figure 9 shows a photograph of the [EVAL-CN0370-PMDZ](#) circuit evaluation board.

Information and details regarding test setup and how to use the evaluation software for data capture can be found in the [CN-0370 Software User Guide](#).

Information regarding the SDP board is available in the [SDP User Guide \(UG-277\)](#).



Figure 9. [EVAL-CN0370-PMDZ](#) Circuit Evaluation Board

LEARN MORE

CN-0370 Design Support Package:

www.analog.com/CN0370-DesignSupport

Kester, Walt. *The Data Conversion Handbook*, Chapter 3 and Chapter 7. Analog Devices, 2005.

AN-1212 Application Note. *Single-Supply Low Noise LED Current Source Driver Using a Current Output DAC in the Reverse Mode*. Analog Devices.

Circuit Note CN-0348. *16-Bit Single-Supply Buffered Voltage Output Digital-to-Analog Conversion with Less Than ± 1 LSB and Differential Nonlinearity*. Analog Devices.

MT-015 Tutorial. *Basic DAC Architectures II: Binary DACs*. Analog Devices.

MT-016 Tutorial. *Basic DAC Architectures III: Segmented DACs*. Analog Devices.

MT-031 Tutorial. *Grounding Data Converters and Solving the Mystery of AGND and DGND*. Analog Devices.

MT-035 Tutorial. *Op Amp Inputs, Outputs, Single-Supply, and Rail-to-Rail Issues*. Analog Devices.

MT-101 Tutorial. *Decoupling Techniques*. Analog Devices.

Data Sheets and Evaluation Boards

[AD5542A Data Sheet](#)

[ADA4500-2 Data Sheet](#)

[ADR4525 Data Sheet](#)

REVISION HISTORY

9/15—Revision 0: Initial Version

(Continued from first page) Circuits from the Lab reference designs are intended only for use with Analog Devices products and are the intellectual property of Analog Devices or its licensors. While you may use the Circuits from the Lab reference designs in the design of your product, no other license is granted by implication or otherwise under any patents or other intellectual property by application or use of the Circuits from the Lab reference designs. Information furnished by Analog Devices is believed to be accurate and reliable. However, Circuits from the Lab reference designs are supplied "as is" and without warranties of any kind, express, implied, or statutory including, but not limited to, any implied warranty of merchantability, noninfringement or fitness for a particular purpose and no responsibility is assumed by Analog Devices for their use, nor for any infringements of patents or other rights of third parties that may result from their use. Analog Devices reserves the right to change any Circuits from the Lab reference designs at any time without notice but is under no obligation to do so.

Компания «Life Electronics» занимается поставками электронных компонентов импортного и отечественного производства от производителей и со складов крупных дистрибьюторов Европы, Америки и Азии.

С конца 2013 года компания активно расширяет линейку поставок компонентов по направлению коаксиальный кабель, кварцевые генераторы и конденсаторы (керамические, пленочные, электролитические), за счёт заключения дистрибьюторских договоров

Мы предлагаем:

- Конкурентоспособные цены и скидки постоянным клиентам.
- Специальные условия для постоянных клиентов.
- Подбор аналогов.
- Поставку компонентов в любых объемах, удовлетворяющих вашим потребностям.
- Приемлемые сроки поставки, возможна ускоренная поставка.
- Доставку товара в любую точку России и стран СНГ.
- Комплексную поставку.
- Работу по проектам и поставку образцов.
- Формирование склада под заказчика.
- Сертификаты соответствия на поставляемую продукцию (по желанию клиента).
- Тестирование поставляемой продукции.
- Поставку компонентов, требующих военную и космическую приемку.
- Входной контроль качества.
- Наличие сертификата ISO.

В составе нашей компании организован Конструкторский отдел, призванный помогать разработчикам, и инженерам.

Конструкторский отдел помогает осуществить:

- Регистрацию проекта у производителя компонентов.
- Техническую поддержку проекта.
- Защиту от снятия компонента с производства.
- Оценку стоимости проекта по компонентам.
- Изготовление тестовой платы монтаж и пусконаладочные работы.



Тел: +7 (812) 336 43 04 (многоканальный)

Email: org@lifeelectronics.ru