

### FEATURES

- 1.8 V to 5.5 V single supply
- 2  $\Omega$  (typ) on resistance
- Low on resistance flatness
- 3 dB bandwidth >200 MHz
- Rail-to-rail operation
- 6-lead and 5-lead SC70 packages
- Fast switching times
  - t<sub>ON</sub> 18 ns
  - t<sub>OFF</sub> 12 ns
- Typical power consumption (<0.01  $\mu$ W)
- TTL-/CMOS-compatible

### APPLICATIONS

- Battery-powered systems
- Communication systems
- Sample-and-hold systems
- Audio signal routing
- Video switching
- Mechanical reed relay replacement

### GENERAL DESCRIPTION

The ADG741/ADG742 are monolithic CMOS SPST switches. These switches are designed using an advanced submicron process that provides low power dissipation, yet offers high switching speed, low on resistance, and low leakage currents. In addition, -3 dB bandwidths of greater than 200 MHz can be achieved.

The ADG741/ADG742 can operate from a single 1.8 V to 5.5 V supply, making them ideal for use in battery-powered instruments and with Analog Devices' new generation of DACs and ADCs.

As shown in the Functional Block Diagrams, with a logic input of 1 the switch of the ADG741 is closed, while that of the ADG742 is open. Each switch conducts equally well in both directions when on.

The ADG741/ADG742 are available in 6-lead and 5-lead SC70 packages.

#### Rev. A

Information furnished by Analog Devices is believed to be accurate and reliable. However, no responsibility is assumed by Analog Devices for its use, nor for any infringements of patents or other rights of third parties that may result from its use. Specifications subject to change without notice. No license is granted by implication or otherwise under any patent or patent rights of Analog Devices. Trademarks and registered trademarks are the property of their respective owners.

### FUNCTIONAL BLOCK DIAGRAMS

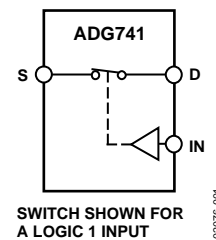

Figure 1.

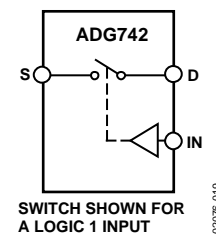

Figure 2.

### PRODUCT HIGHLIGHTS

1. 1.8 V to 5.5 V Single-Supply Operation.  
The ADG741/ADG742 offer high performance, including low on resistance and fast switching times. They are fully specified and guaranteed with 3 V and 5 V supply rails.
2. Very Low R<sub>ON</sub> (3  $\Omega$  max at 5 V, 5  $\Omega$  max at 3 V).  
At 1.8 V operation, R<sub>ON</sub> is typically 40  $\Omega$  over the temperature range.
3. On Resistance Flatness R<sub>FLAT(ON)</sub> (1  $\Omega$  max).
4. -3 dB Bandwidth >200 MHz.
5. Low Power Dissipation.  
CMOS construction ensures low power dissipation.
6. Fast t<sub>ON</sub>/t<sub>OFF</sub>.
7. Tiny 6-Lead and 5-Lead SC70 Packages.

**TABLE OF CONTENTS**

Specifications.....	3	Applications Information .....	10
Absolute Maximum Ratings.....	5	Supply Voltages.....	10
ESD Caution.....	5	On Response vs. Frequency .....	10
Pin Configurations and Function Descriptions .....	6	Off Isolation .....	10
Typical Performance Characteristics .....	7	Outline Dimensions .....	11
Terminology .....	8	Ordering Guide .....	11
Test Circuits.....	9		

**REVISION HISTORY**

**3/05—Rev. 0 to Rev. A**

Added 5-Lead Package.....	Universal
Change to Absolute Maximum Ratings.....	5
Inserted New Figure 4.....	6
Added Terminology Section .....	8
Replaced Figure 11, Figure 12, and Figure 13.....	9
Updated Outline Dimensions .....	12
Changes to Ordering Guide .....	12

**10/00—Revision 0: Initial Version**

## SPECIFICATIONS

$V_{DD} = 5\text{ V} \pm 10\%$ ,  $GND = 0\text{ V}$ . All specifications  $-40^{\circ}\text{C}$  to  $+85^{\circ}\text{C}$ , unless otherwise noted.

**Table 1.**

Parameter	B Version		Unit	Test Conditions/Comments
	25°C	-40°C to +85°C		
<b>ANALOG SWITCH</b>				
Analog Signal Range	0 V to $V_{DD}$		V	
On Resistance ( $R_{ON}$ )	2		$\Omega$ typ	$V_S = 0\text{ V}$ to $V_{DD}$ , $I_S = -10\text{ mA}$ ; Figure 11
On Resistance Flatness ( $R_{FLAT(ON)}$ )	3	4	$\Omega$ max	
	0.5	1.0	$\Omega$ typ $\Omega$ max	$V_S = 0\text{ V}$ to $V_{DD}$ , $I_S = -10\text{ mA}$
<b>LEAKAGE CURRENTS<sup>1</sup></b>				
Source OFF Leakage $I_S$ (OFF)	$\pm 0.01$		nA typ	$V_{DD} = 5.5\text{ V}$ $V_S = 4.5\text{ V}/1\text{ V}$ , $V_D = 1\text{ V}/4.5\text{ V}$ ; Figure 12
Drain OFF Leakage $I_D$ (OFF)	$\pm 0.25$	$\pm 0.35$	nA max	
	$\pm 0.01$		nA typ	$V_S = 4.5\text{ V}/1\text{ V}$ , $V_D = 1\text{ V}/4.5\text{ V}$ ; Figure 12
Channel ON Leakage $I_D$ , $I_S$ (ON)	$\pm 0.25$	$\pm 0.35$	nA max	
	$\pm 0.01$		nA typ	$V_S = V_D = 1\text{ V}$ , or $4.5\text{ V}$ ; Figure 13
<b>DIGITAL INPUTS</b>				
Input High Voltage, $V_{INH}$	2.4		V min	
Input Low Voltage, $V_{INL}$	0.8		V max	
Input Current				
$I_{INL}$ or $I_{INH}$	0.005		$\mu\text{A}$ typ $\mu\text{A}$ max	$V_{IN} = V_{INL}$ or $V_{INH}$
		$\pm 0.1$		
<b>DYNAMIC CHARACTERISTICS<sup>1</sup></b>				
$t_{ON}$	12		ns typ	$R_L = 300\ \Omega$ , $C_L = 35\text{ pF}$ $V_S = 3\text{ V}$ ; Figure 14
$t_{OFF}$	8	18	ns max	
		12	ns typ	$R_L = 300\ \Omega$ , $C_L = 35\text{ pF}$ $V_S = 3\text{ V}$ ; Figure 14
Charge Injection	5		pC typ	$V_S = 2\text{ V}$ , $R_S = 0\ \Omega$ , $C_L = 1\text{ nF}$ ; Figure 15
Off Isolation	-55		dB typ	$R_L = 50\ \Omega$ , $C_L = 5\text{ pF}$ , $f = 10\text{ MHz}$
Bandwidth -3 dB	-75		dB typ	$R_L = 50\ \Omega$ , $C_L = 5\text{ pF}$ , $f = 1\text{ MHz}$ ; Figure 16
	200		MHz typ	$R_L = 50\ \Omega$ , $C_L = 5\text{ pF}$ ; Figure 17
$C_S$ (OFF)	17		pF typ	
$C_D$ (OFF)	17		pF typ	
$C_D$ , $C_S$ (ON)	38		pF typ	
<b>POWER REQUIREMENTS</b>				
$I_{DD}$	0.001		$\mu\text{A}$ typ $\mu\text{A}$ max	$V_{DD} = 5.5\text{ V}$ Digital Inputs = 0 V or 5 V
		1.0		

<sup>1</sup> Guaranteed by design; not subject to production test.

# ADG741/ADG742

$V_{DD} = 3\text{ V} \pm 10\%$ ,  $GND = 0\text{ V}$ . All specifications  $-40^{\circ}\text{C}$  to  $+85^{\circ}\text{C}$ , unless otherwise noted.

**Table 2.**

Parameter	B Version		Unit	Test Conditions/Comments
	25°C	-40°C to +85°C		
<b>ANALOG SWITCH</b>				
Analogue Signal Range		0 V to $V_{DD}$	V	
On Resistance ( $R_{ON}$ )	3.5		$\Omega$ typ	$V_S = 0\text{ V}$ to $V_{DD}$ , $I_S = -10\text{ mA}$ ; Figure 11
	5	6	$\Omega$ max	
On Resistance Flatness ( $R_{FLAT(ON)}$ )	1.5		$\Omega$ typ	$V_S = 0\text{ V}$ to $V_{DD}$ , $I_S = -10\text{ mA}$
<b>LEAKAGE CURRENTS<sup>1</sup></b>				
Source OFF Leakage $I_S$ (OFF)	$\pm 0.01$		nA typ	$V_{DD} = 3.3\text{ V}$ $V_S = 3\text{ V}/1\text{ V}$ , $V_D = 1\text{ V}/3\text{ V}$ ; Figure 12
	$\pm 0.25$	$\pm 0.35$	nA max	
Drain OFF Leakage $I_D$ (OFF)	$\pm 0.01$		nA typ	$V_S = 3\text{ V}/1\text{ V}$ , $V_D = 1\text{ V}/3\text{ V}$ ; Figure 12
	$\pm 0.25$	$\pm 0.35$	nA max	
Channel ON Leakage $I_D, I_S$ (ON)	$\pm 0.01$		nA typ	$V_S = V_D = 1\text{ V}$ , or $3\text{ V}$ ; Figure 13
	$\pm 0.25$	$\pm 0.35$	nA max	
<b>DIGITAL INPUTS</b>				
Input High Voltage, $V_{INH}$		2.0	V min	
Input Low Voltage, $V_{INL}$		0.4	V max	
Input Current $I_{INL}$ or $I_{INH}$	0.005		$\mu\text{A}$ typ	$V_{IN} = V_{INL}$ or $V_{INH}$
		$\pm 0.1$	$\mu\text{A}$ max	
<b>DYNAMIC CHARACTERISTICS<sup>1</sup></b>				
$t_{ON}$	14		ns typ	$R_L = 300\ \Omega$ , $C_L = 35\text{ pF}$ $V_S = 2\text{ V}$ , Figure 14
		20	ns max	
$t_{OFF}$	8		ns typ	$R_L = 300\ \Omega$ , $C_L = 35\text{ pF}$ $V_S = 2\text{ V}$ , Figure 14
		13	ns max	
Charge Injection	4		pC typ	$V_S = 1.5\text{ V}$ , $R_S = 0\ \Omega$ , $C_L = 1\text{ nF}$ ; Figure 15
Off Isolation	-55		dB typ	$R_L = 50\ \Omega$ , $C_L = 5\text{ pF}$ , $f = 10\text{ MHz}$
	-75		dB typ	$R_L = 50\ \Omega$ , $C_L = 5\text{ pF}$ , $f = 1\text{ MHz}$ ; Figure 16
Bandwidth -3 dB	200		MHz typ	$R_L = 50\ \Omega$ , $C_L = 5\text{ pF}$ ; Figure 17
$C_S$ (OFF)	17		pF typ	
$C_D$ (OFF)	17		pF typ	
$C_D, C_S$ (ON)	38		pF typ	
<b>POWER REQUIREMENTS</b>				
$I_{DD}$	0.001		$\mu\text{A}$ typ	$V_{DD} = 3.3\text{ V}$ Digital Inputs = 0 V or 3 V
		1.0	$\mu\text{A}$ max	

<sup>1</sup> Guaranteed by design; not subject to production test.

## ABSOLUTE MAXIMUM RATINGS

$T_A = 25^\circ\text{C}$ , unless otherwise noted.

**Table 3.**

Parameters	Ratings
$V_{DD}$ to GND	-0.3 V to +7 V
Analog, Digital Inputs <sup>1</sup>	-0.3 V to $V_{DD} + 0.3$ V or 30 mA, Whichever Occurs First
Continuous Current, S or D	30 mA
Peak Current, S or D (Pulsed at 1ms, 10% Duty Cycle Max)	100 mA
Operating Temperature Range	
Industrial (B Version)	-40°C to +85°C
Storage Temperature Range	-65°C to +150°C
Junction Temperature	150°C
SC70 Package	
$\theta_{JA}$ Thermal Impedance	494.8°C/W
$\theta_{JC}$ Thermal Impedance	120°C/W
Lead Temperature, Soldering	
Vapor Phase (60 sec)	215°C
Infrared (15 sec)	220°C
ESD	1.5 kV

<sup>1</sup> Overvoltages at IN, S, or D will be clamped by internal diodes. Current should be limited to the maximum ratings given.

Stresses above those listed under Absolute Maximum Ratings may cause permanent damage to the device. This is a stress rating only; functional operation of the device at these or any other conditions above those listed in the operational sections of this specification is not implied. Exposure to absolute maximum rating conditions for extended periods may affect device reliability. Only one absolute maximum rating may be applied at any one time.

**Table 4. Truth Table**

ADG741 In	ADG742 In	Switch Condition
0	1	OFF
1	0	ON

### ESD CAUTION

ESD (electrostatic discharge) sensitive device. Electrostatic charges as high as 4000 V readily accumulate on the human body and test equipment and can discharge without detection. Although this product features proprietary ESD protection circuitry, permanent damage may occur on devices subjected to high energy electrostatic discharges. Therefore, proper ESD precautions are recommended to avoid performance degradation or loss of functionality.



# ADG741/ADG742

## PIN CONFIGURATIONS AND FUNCTION DESCRIPTIONS



Figure 3. 6-Lead Pin Configuration



Figure 4. 5-Lead Pin Configuration

Table 5. Pin Function Descriptions

Pin No. (6-Lead)	Pin No. (5-Lead)	Mnemonic	Description
1	1	D	Drain Terminal. May be an input or output.
2	2	S	Source Terminal. May be an input or output.
3	3	GND	Ground (0 V) Reference.
4	4	IN	Logic Control Input.
5	-	NC	No Connect.
6	5	V <sub>DD</sub>	Most Positive Power Supply Potential.

# TYPICAL PERFORMANCE CHARACTERISTICS

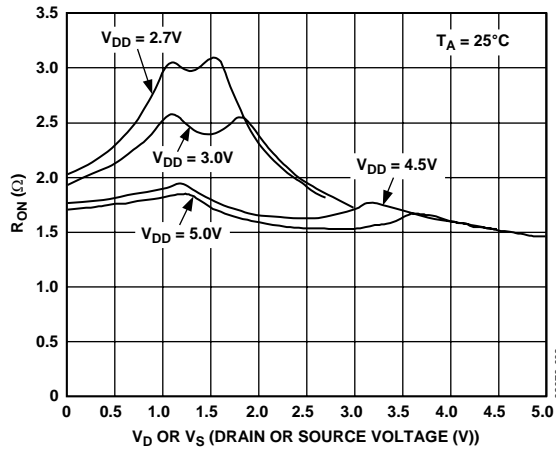

Figure 5. On Resistance as a Function of  $V_D$  ( $V_S$ ) Single Supplies

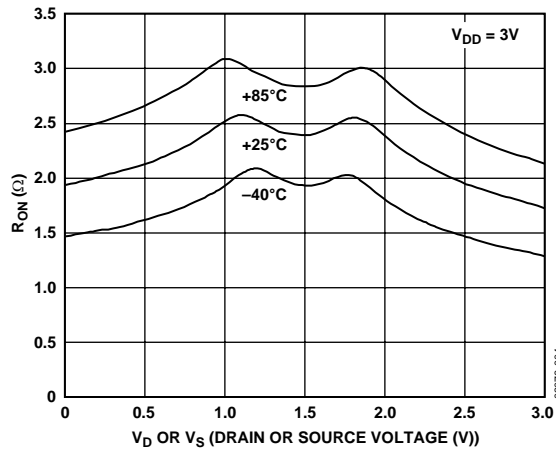

Figure 6. On Resistance as a Function of  $V_D$  ( $V_S$ ) for Different Temperatures  $V_{DD} = 3V$

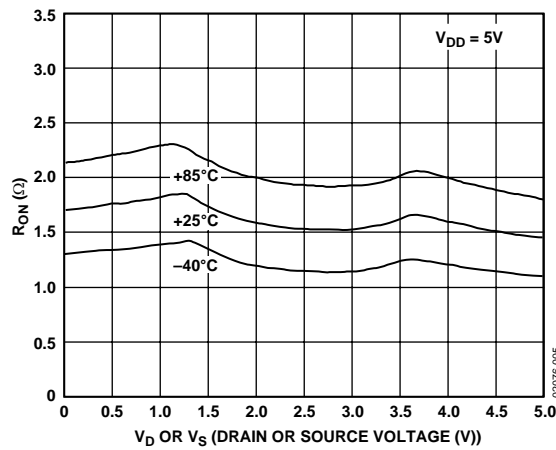

Figure 7. On Resistance as a Function of  $V_D$  ( $V_S$ ) for Different Temperatures  $V_{DD} = 5V$

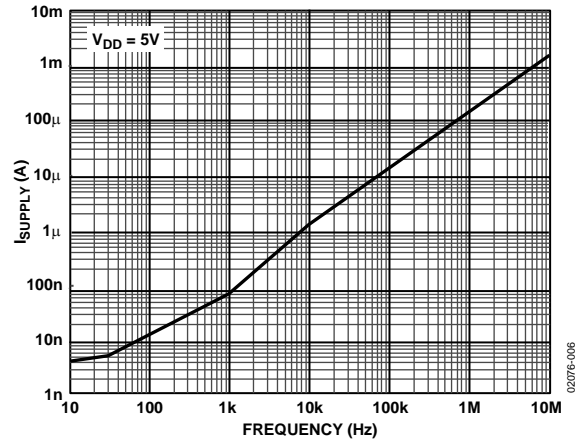

Figure 8. Supply Current vs. Input Switching Frequency

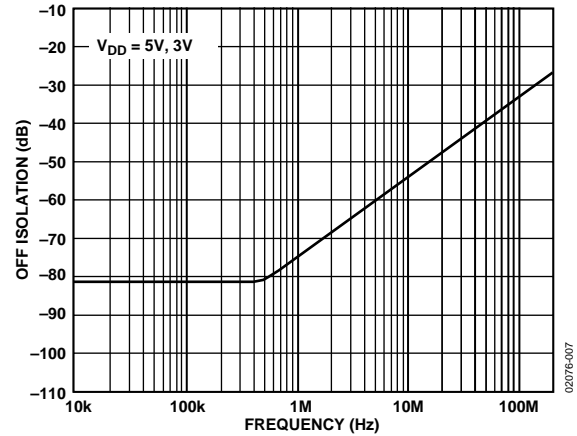

Figure 9. Off Isolation vs. Frequency

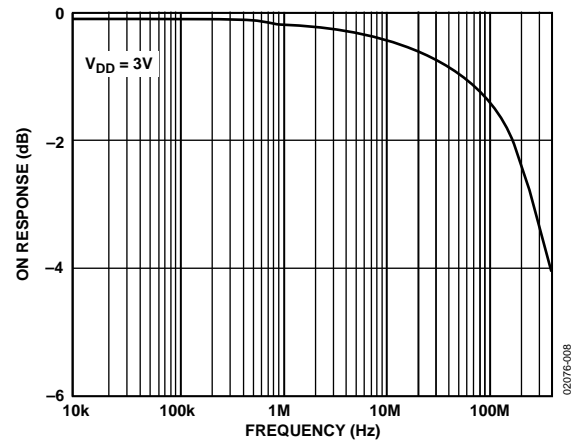

Figure 10. On Response vs. Frequency

## TERMINOLOGY

### **R<sub>ON</sub>**

Ohmic resistance between D and S.

### **R<sub>FLAT (ON)</sub>**

Flatness is defined as the difference between the maximum and minimum value of on resistance as measured.

### **I<sub>S (OFF)</sub>**

Source leakage current with the switch off.

### **I<sub>D (OFF)</sub>**

Drain leakage current with the switch off.

### **I<sub>D</sub>, I<sub>S (ON)</sub>**

Channel leakage current with the switch on.

### **V<sub>D (V<sub>S</sub>)</sub>**

Analog voltage on Terminal D and Terminal S.

### **C<sub>S (OFF)</sub>**

Off switch source capacitance. Measured with reference to ground.

### **C<sub>D (OFF)</sub>**

Off switch drain capacitance. Measured with reference to ground.

### **C<sub>D</sub>, C<sub>S (ON)</sub>**

On switch capacitance. Measured with reference to ground.

### **t<sub>ON</sub>**

Delay time between the 50% and the 90% points of the digital input and switch on condition. See Figure 14.

### **t<sub>OFF</sub>**

Delay time between the 50% and the 90% points of the digital input and switch off condition.

### **Off Isolation**

A measure of unwanted signal coupling through an off switch.

### **Charge Injection**

A measure of the glitch impulse transferred from the digital input to the analog output during on-off switching.

### **Bandwidth**

The frequency at which the output is attenuated by -3 dB.

### **On Response**

The frequency response of the on switch.

### **On Loss**

The voltage drop across the on switch as how many dBs the signal is away from 0 dB at very low frequencies. See Figure 10.



TEST CIRCUITS

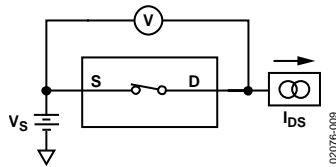

Figure 11. On Resistance

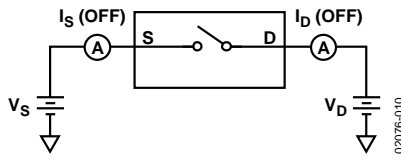

Figure 12. Off Leakage



Figure 13. On Leakage

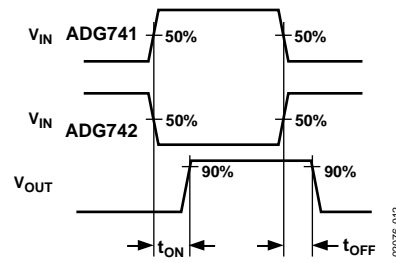

Figure 14. Switching Times

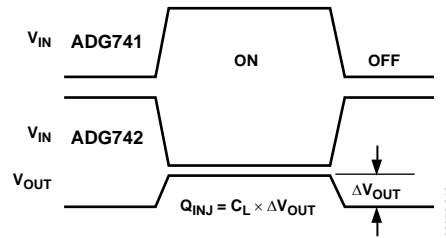
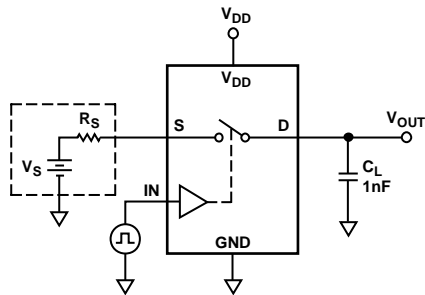

Figure 15. Charge Injection

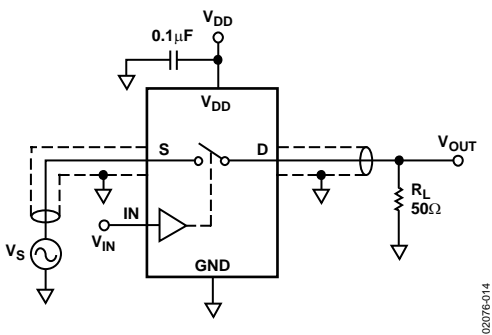

Figure 16. Off Isolation

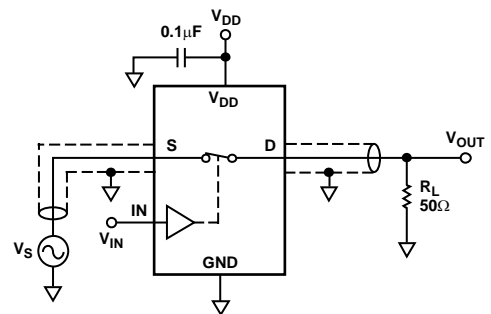

Figure 17. Bandwidth

## APPLICATIONS INFORMATION

The ADG741/ADG742 belong to Analog Devices' family of CMOS switches. This series of general-purpose switches offers improved switching times, lower on resistance, higher bandwidth, low power consumption, and low leakage currents.

### SUPPLY VOLTAGES

Functionality of the ADG741/ADG742 extends from 1.8 V to 5.5 V single supply, which makes them ideal for battery-powered instruments where important design parameters are power, efficiency, and performance.

It is important to note that the supply voltage affects the input signal range, the on resistance, and the switching times of the part. By looking at the typical performance characteristics and the specifications, the effects of the power supplies can be clearly seen.

For  $V_{DD} = 1.8$  V operation,  $R_{ON}$  is typically 40  $\Omega$  over the temperature range.

### ON RESPONSE VS. FREQUENCY

Figure 18 illustrates the parasitic components that affect the ac performance of CMOS switches (the switch is shown surrounded by a box). Additional external capacitances will further degrade some performance. These capacitances affect feedthrough, crosstalk, and system bandwidth.



Figure 18. Switch Represented by Equivalent Parasitic Components

The transfer function that describes the equivalent diagram of the switch (Figure 18) is of the form  $A(s)$ , as shown below.

$$A(s) = R_T \left[ \frac{s(R_{ON} C_{DS}) + 1}{s(R_{ON} C_T R_T) + 1} \right]$$

where:

$$C_T = C_{LOAD} + C_D + C_{DS}$$

$$R_T = R_{LOAD} / (R_{LOAD} + R_{ON})$$

The signal transfer characteristic is dependent on the switch channel capacitance,  $C_{DS}$ . This capacitance creates a frequency zero in the numerator of the transfer function  $A(s)$ . Because the switch on resistance is small, this zero usually occurs at high frequencies. The bandwidth is a function of the switch output capacitance combined with  $C_{DS}$  and the load capacitance. The frequency pole corresponding to these capacitances appears in the denominator of  $A(s)$ .

The dominant effect of the output capacitance,  $C_D$ , causes the pole breakpoint frequency to occur first. To maximize bandwidth, a switch must have a low input and output capacitance and low on resistance. The on response vs. frequency is shown in Figure 10.

### OFF ISOLATION

Off isolation is a measure of the input signal coupled through an off switch to the switch output. The capacitance,  $C_{DS}$ , couples the input signal to the output load when the switch is off, as shown in Figure 19.

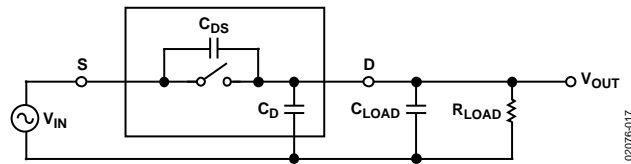

Figure 19. Off Isolation Affected by External Load Resistance and Capacitance

The larger the value of  $C_{DS}$ , the larger the value of feedthrough that will be produced. The typical performance characteristic graph of Figure 9 illustrates the drop in off isolation as a function of frequency. From dc to roughly 1 MHz, the switch shows better than -75 dB isolation. Up to frequencies of 10 MHz, the off isolation remains better than -55 dB. As the frequency increases, more and more of the input signal is coupled through to the output. Off isolation can be maximized by choosing a switch with the smallest  $C_{DS}$  possible. The values of load resistance and capacitance affect off isolation also, as they contribute to the coefficients of the poles and zeros in the transfer function of the switch when open.

$$A(s) = \left[ \frac{s(R_{LOAD} C_{DS})}{s(R_{LOAD})(C_T) + 1} \right]$$

## OUTLINE DIMENSIONS



COMPLIANT TO JEDEC STANDARDS MO-203-AB

Figure 20. 6-Lead Thin Shrink Small Outline Transistor Package [SC70] (KS-6)  
Dimensions shown in millimeters



COMPLIANT TO JEDEC STANDARDS MO-203AA

Figure 21. 5-Lead Thin Shrink Small Outline Transistor Package [SC70] (KS-5)  
Dimensions shown in millimeters

## ORDERING GUIDE

Model	Temperature Range	Brand <sup>1</sup>	Package Description	Package Option
ADG741BKS-R2	-40°C to +85°C	SFB	6-lead SC70	KS-6
ADG741BKS-REEL	-40°C to +85°C	SFB	6-lead SC70	KS-6
ADG741BKS-REEL7	-40°C to +85°C	SFB	6-lead SC70	KS-6
ADG741BKSZ-REEL <sup>2</sup>	-40°C to +85°C	S00	6-lead SC70	KS-6
ADG741BKSZ5-REEL <sup>2</sup>	-40°C to +85°C	S00	5-lead SC70	KS-5
ADG741BKSZ5-REEL7 <sup>2</sup>	-40°C to +85°C	S00	5-lead SC70	KS-5
ADG742BKS-R2	-40°C to +85°C	SGB	6-lead SC70	KS-6
ADG742BKS-REEL	-40°C to +85°C	SGB	6-lead SC70	KS-6
ADG742BKS-REEL7	-40°C to +85°C	SGB	6-lead SC70	KS-6
ADG742BKSZ-R2 <sup>2</sup>	-40°C to +85°C	S01	6-lead SC70	KS-6
ADG742BKSZ-REEL <sup>2</sup>	-40°C to +85°C	S01	6-lead SC70	KS-6
ADG742BKSZ-REEL7 <sup>2</sup>	-40°C to +85°C	S01	6-lead SC70	KS-6
ADG742BKSZ5-REEL <sup>2</sup>	-40°C to +85°C	S01	5-lead SC70	KS-5
ADG742BKSZ5-REEL7 <sup>2</sup>	-40°C to +85°C	S01	5-lead SC70	KS-5

<sup>1</sup> Brand on these packages is limited to three characters due to space constraints.

<sup>2</sup> Z = Pb-free part.

**NOTES**

Компания «Life Electronics» занимается поставками электронных компонентов импортного и отечественного производства от производителей и со складов крупных дистрибьюторов Европы, Америки и Азии.

С конца 2013 года компания активно расширяет линейку поставок компонентов по направлению коаксиальный кабель, кварцевые генераторы и конденсаторы (керамические, пленочные, электролитические), за счёт заключения дистрибьюторских договоров

Мы предлагаем:

- Конкурентоспособные цены и скидки постоянным клиентам.
- Специальные условия для постоянных клиентов.
- Подбор аналогов.
- Поставку компонентов в любых объемах, удовлетворяющих вашим потребностям.
- Приемлемые сроки поставки, возможна ускоренная поставка.
- Доставку товара в любую точку России и стран СНГ.
- Комплексную поставку.
- Работу по проектам и поставку образцов.
- Формирование склада под заказчика.
- Сертификаты соответствия на поставляемую продукцию (по желанию клиента).
- Тестирование поставляемой продукции.
- Поставку компонентов, требующих военную и космическую приемку.
- Входной контроль качества.
- Наличие сертификата ISO.

В составе нашей компании организован Конструкторский отдел, призванный помогать разработчикам, и инженерам.

Конструкторский отдел помогает осуществить:

- Регистрацию проекта у производителя компонентов.
- Техническую поддержку проекта.
- Защиту от снятия компонента с производства.
- Оценку стоимости проекта по компонентам.
- Изготовление тестовой платы монтаж и пусконаладочные работы.



Тел: +7 (812) 336 43 04 (многоканальный)

Email: [org@lifeelectronics.ru](mailto:org@lifeelectronics.ru)