

Table of Contents



The Pulse Electronics 0402 - 1806 series ranges of Miniature Ferrite beads contains the very latest in multi layer ferrite beads technology, thus providing the ultimate in performance demanded by today's high Speed EMI noise filtering products. The ferrite beads are in an industry standard size and footprint.

Ferrite beads	2
Parts number Legend	2
Competitor Cross	3
Reliability and Test Condition	3-5
Derating Curve	5
Product Specifications	
Soldering	5
Lead Free Solder re-flow	6
Solder Iron	6
Solder Volume	6
Packaging Information	7
Reel Dimension	7
Qty/reel	7
Tearing Off Force	7
Application Notes	8
Ferrite Bead EMI Suppressor	
Single Type - 0402FB, 0603FB & 0805FB Series	9-10
Single GHz Type - 00402HFB & 0603HFB Series	11-12
Power Type - 0603PFB, 0805PFB, 1206PFB, & 1806PFB Series	13-14

CHIP FERRITE BEADS

1.0 Ferrite Beads

It is known as absorptive beads, is more lossy and make good power filter networks because they are designed to absorb high-frequency noise currents and dissipate it as heat. These beads have high impedance over wide high-frequency bands, making them ideal as low-pass noise filters.

Structure



Equivalent Circuit

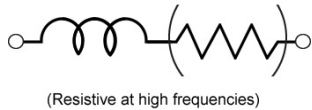

FREQUENCY (MHz)
 Z = Impedance (ohm)
 R = Real Part (resistance)
 X = imaginary Part (inductance)

Application



2.0 Parts Number Legend

PE-0201	FB	121	S	T	A
PACKAGE STYLE	CORE MATERIAL	Impedance (Ω)	TOLERANCE *	PACKAGE	Enhanced
0402, 0603, 0805, 1206 1806	FB = Ferrite Bead HFB = High Frequency Ferrite Bead PFB = High Current Ferrite Bead	121=120 Ω	J = $\pm 5\%$ S = $\pm 25\%$ X = not apply	T = Tape & Reel	A = Alternative

* There is no tolerance option for these products.

CHIP FERRITE BEADS

3.0 Competitor Cross

ITEM	Pulse	TAIYO YUDEN	TDK	MURATA
Ferrite Bead Single	FB Series	BK & FBM Series	MMZ Series	BLMxxAG Series BLMxxBD Series BLMxxAX Series
GHz Ferrite Beads Single	HFB Series	FBMH Series	MMZ1005-E Series	BLMxxH Series
Power Ferrite Bead Single	PFB Series			BLMxxPG Series

4.0 Reliability and Test Condition

Item	Performance	Test Condition
Series No.	PE-0402FB/0603FB/0805FB/0402HFB/0603HFB/	
Operating Temperature	-40 ~+105°C (Including self-temperature rise)	
Transportation Storage Temperature	-40 ~+125°C	
Impedance (Z)	Refer to standard electrical characteristics list	Agilent4291
Inductance (Ls)		AgilentE4991
Q Factor		Agilent4287
DC Resistance		Agilent16192
Rated Current		Agilent4338 DC Power Supply Over Rated Current requirements
Temperature Rise Test	Rated Current < 1A ΔT 20°C Max Rated Current \geq 1A ΔT 20°C Max	1. Applied the allowed DC current 2. Temperature measured by digital surface thermometer
Resistance to Soldering Heat	Appearance: No damage Impedance: Within $\pm 15\%$ of initial value Inductance: Within $\pm 10\%$ of initial value Q: Shall not exceed the specification value. RDC: Shall not exceed the specification value.	Preheat: 150°C, 60sec Solder: Sn99.5%-Cu0.5% Solder temperature: 260 \pm 5°C Flux for lead free: Rosin.9.5% Temperature ramp/immersion and immersion rate: 25 \pm 6 mm/s Dip time: 10 \pm 1sec. Depth: completely cover the termination.

CHIP FERRITE BEADS

4.0 Reliability and Test Condition

Item	Performance	Test Condition															
Solderability	<p>More than 95% of the terminal electrode should be covered with solder</p> 	<p>Preheat: 150°C, 60sec</p> <p>Solder: Sn99.5%-Cu0.5%</p> <p>Solder temperature: 245±5°C</p> <p>Flux for lead free: Rosin.9.5%</p> <p>Depth: completely cover the termination.</p> <p>Dip time: 4±1sec.</p>															
Terminal strength	<p>Appearance: No damage.</p> <p>Impedance: within ±15% of initial value</p> <p>Inductance: within ±10% of initial value</p> <p>Q: Shall not exceed the specification value.</p> <p>RDC: Shall not exceed the specification value.</p> 	<p>Preconditioning: Run through IR reflow for 2 times. (IPC/JEDEC J-STD-020E Classification Reflow Profiles)</p> <p>Component mounted on a PCB apply a force (>0805:1kg<=0805:0.5kg) to the side of a device being tested. This force shall be applied for 60 +1 seconds. Also the force shall be applied gradually as not to shock the component being tested.</p>															
Bending	<p>Appearance: No damage.</p> <p>Impedance: within ±10% of initial value</p> <p>Inductance: within ±10% of initial value</p> <p>Q: Shall not exceed the specification value</p> <p>RDC: Shall not exceed the specification value</p>	<p>Shall be mounted on a FR4 substrate of the following dimensions: >=0805:40x100x1.2mm <0805:40x100x0.8mm</p> <p>Bending depth: >=0805:1.2mm</p> <p>Duration of 10 sec for a min.</p>															
Vibration Test	<p>Appearance: No damage.</p> <p>Impedance: within ±15% of initial value</p> <p>Inductance: within ±10% of initial value</p> <p>Q: Shall not exceed the specification value</p> <p>RDC: within ±15% of initial value and shall not exceed the specification value</p>	<p>Preconditioning: Run through IR reflow for 2 times. (IPC/JEDEC J-STD-020E Classification Reflow Profiles)</p> <p>Oscillation Frequency: 10 2K 10Hz for 20 minutes</p> <p>Equipment: Vibration checker</p> <p>Total Amplitude: 1.52mm ±10%</p> <p>Testing Time: 12 hours (20 minutes 12 cycles each of 3 orientations).</p>															
Shock	<p>Appearance: No damage.</p> <p>Impedance: within ±15% of initial value</p> <p>Inductance: within ±10% of initial value</p> <p>Q: Shall not exceed the specification value</p> <p>RDC: within ±15% of initial value and shall not exceed the specification value</p>	<p>Test condition:</p> <table border="1" data-bbox="1062 1650 1500 1860"> <thead> <tr> <th>Type</th> <th>Peak Value (g's)</th> <th>Normal duration (D) (ms)</th> <th>Wave form</th> <th>Velocity change (Vi)ft/sec</th> </tr> </thead> <tbody> <tr> <td>SMD</td> <td>1,500</td> <td>0.5</td> <td>Half-sine</td> <td>15.4</td> </tr> <tr> <td>Lead</td> <td>100</td> <td>6</td> <td>Half-sine</td> <td>12.3</td> </tr> </tbody> </table>	Type	Peak Value (g's)	Normal duration (D) (ms)	Wave form	Velocity change (Vi)ft/sec	SMD	1,500	0.5	Half-sine	15.4	Lead	100	6	Half-sine	12.3
Type	Peak Value (g's)	Normal duration (D) (ms)	Wave form	Velocity change (Vi)ft/sec													
SMD	1,500	0.5	Half-sine	15.4													
Lead	100	6	Half-sine	12.3													

CHIP FERRITE BEADS

Life Test	Appearance: No damage. Impedance: within $\pm 15\%$ of initial value Inductance: within $\pm 10\%$ of initial value Q: Shall not exceed the specification value RDC: within $\pm 15\%$ of initial value and shall not exceed the specification value	Preconditioning: Run through IR reflow for 2 times. (IPC/JEDEC J-STD-020E Classification Reflow Profiles) Temperature: $125 \pm 2^\circ\text{C}$ (bead), $85 \pm 2^\circ\text{C}$ (inductor) Applied current: rated current Duration: 1000 ± 12 hrs. Measured at room temperature after placing for 24 ± 2 hrs.
Load Humidity		Preconditioning: Run through IR reflow for 2 times. (IPC/JEDEC J-STD-020E Classification Reflow Profiles) Humidity: $85 \pm 2\%$ R.H. Temperature: $85 \pm 2^\circ\text{C}$ Duration: 1000hrs Min. with 100% rated current. Measured at room temperature after placing for 24 ± 2 hrs.
Thermal Shock	Appearance: no damage Impedance: within $\pm 15\%$ of initial value Inductance: within $\pm 10\%$ of initial value Q: Shall not exceed the specification value RDC: Shall not exceed the specification value	Preconditioning: Run through IR reflow for 2 times. (IPC/JEDEC J-STD-020E Classification Reflow Profiles) Condition for 1 cycle Step1: $-40 \pm 2^\circ\text{C}$ 30 ± 5 min. Step2: $25 \pm 2^\circ\text{C} \leq 30 \pm 0.5$ min. Step3: $+105 \pm 2^\circ\text{C}$ 30 ± 5 min. Number of cycles: 500 Measured at room temperature after placing for 24 ± 2 hrs.
Insulation Resistance	$IR > 1G\Omega$	Chip Inductor Only Test Voltage: $100 \pm 10\%$ V for 30Sec

5. **Derating Curve

For the ferrite chip bead which withstanding current over 1.5A, as operating temperature over 85°C , the derating current information is necessary to consider. For the detail derating of current, please refer to the Derated Current vs. perating Temperature curve.



6. Soldering

Mildly activated rosin fluxes are preferred. The termination are suitable for re-flow soldering systems. If hand soldering cannot be avoided, the preferred technique is the utilization of hot air soldering tools. Note. If wave soldering is used, there will be some risk. Re-flow soldering temperatures below 240 degrees, there will be non-wetting risk.

CHIP FERRITE BEADS

6.1 Lead Free Solder re-flow

Recommended temperature profiles for lead free re-flow soldering in Figure 1. Reflow times: 3 times max



Figure 1

6.2 Solder Iron



Figure 2 (1 time max)

Products attachment with a soldering iron is discouraged due to the inherent process control limitations. If a soldering iron must be employed the following precautions are recommended. For Iron Soldering in Figure 2.

- Preheat circuit and products to 150°C
- 350°C tip temperature (max)
- Never contact the ceramic with the iron flip
- 1.00mm tip diameter (max)
- Use a 20 watt soldering iron with tip diameter of 1.0mm
- Limited soldering time to 4-5sec

6.3 Solder Volume

Accordingly increasing the solder volume, the mechanical stress to product is also increased. Exceeding solder volume may cause the failure of mechanical or electrical performance. Solder shall be used not to be exceed as shown in the right side:

Minimum fillet height = soldering thickness + 25% product height



CHIP FERRITE BEADS

7. Packaging Information

7.1 Reel Dimension

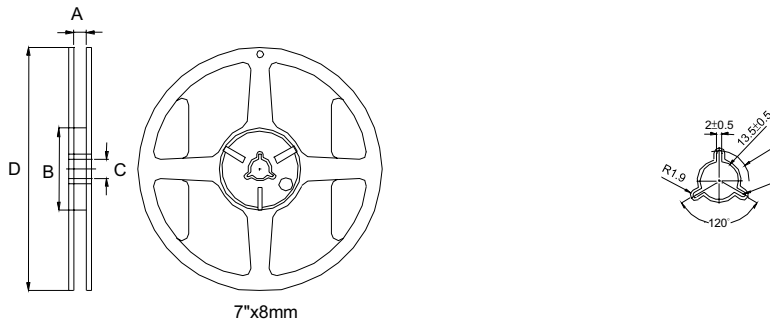

Type	A(mm)	B(mm)	C(mm)	D(mm)
7"x8mm	10.0±1.5	50 or more	13±0.2	178±2

7.2 Qty/reel

Chip Size	Chip/Reel	Reel Diameter
PE-0402HFB	10000	178 x 8mm
PE-0402FB	10000	178 x 8mm
PE-0603FB	4000	178 x 8mm
PE-0603HFB	4000	178 x 8mm
PE-0603PFB	4000	178 x 8mm
PE-0805FB	4000	178 x 8mm
PE-0805PFB	4000	178 x 8mm
PE-1206PFB	3000	178 x 8mm
PE-1806PFB	3000	178 x 8mm

7.3 Tearing Off Force



The force for tearing off cover tape is 15 to 60 grams in the arrow direction under the following conditions.

Room Temp. (C)	Room Humidity (%)	Room atm (hPa)	Tearing Speed mm/min
5~35	45~85	860~1060	300

CHIP FERRITE BEADS

Application Notice

*Storage Conditions

To maintain the solder ability of terminal electrodes:

1. Products meet IPC/JEDEC J-STD-020E standard-MSL, level 1.
2. Temperature and humidity conditions: Less than 40 °C and 60% RH.
3. Recommended products should be used within 12 months from the time of delivery.
4. The packaging material should be kept where no chlorine or sulfur exists in the air.

* Transportation

1. Products should be handled with care to avoid damage or contamination from perspiration and skin oils.
2. The use of tweezers or vacuum pick up is strongly recommended for individual components.
3. Bulk handling should ensure that abrasion and mechanical shock are minimized.

FERRITE BEAD EMI SUPPRESSOR SINGLE TYPE - FB SERIES FOR GENERAL SIGNAL LINE



- Ⓜ Signal Line EMI Suppression
- Ⓜ Monolithic inorganic material construction
- Ⓜ Various impedance and frequency application
- Ⓜ Industry Standard package

Electrical Specifications @ 25°C

Part Number	Impedance (Ω)	Tolerance	Test Frequency (MHz)	DC Resistance (Ω) max.	Rated Current (mA) max.
PE-0402FB100XT	0 ~ 15	-	100	0.03	1000
PE-0402FB121ST	120	±25%	100	0.2	550
PE-0402FB601ST	600	±25%	100	0.55	300
PE-0402FB102ST	1000	±25%	100	0.58	300
PE-0603FB121ST	120	±25%	100	0.18	500
PE-0603FB221ST	220	±25%	100	0.25	500
PE-0603FB601ST	600	±25%	100	0.38	500
PE-0603FB102ST	1000	±25%	100	0.5	400
PE-0805FB121ST	120	±25%	100	0.15	800
PE-0805FB601ST	600	±25%	100	0.3	500
PE-0805FB102ST	1000	±25%	100	0.4	500

Mechanicals

Application

PE-0402/0805FB

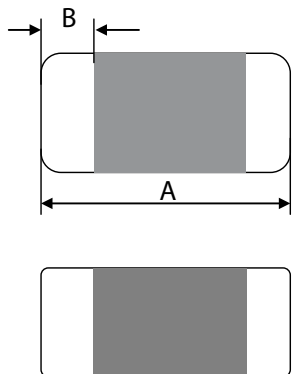

Unit: mm

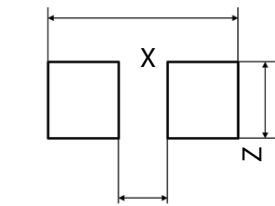
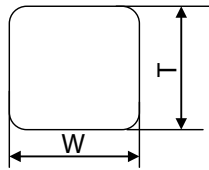

SUGGESTED LAND PATTERN

Dimension:

Imperial Size	A	B	W	T	X	Y	Z
0402	1.0±0.15	0.25±0.1	0.5±0.15	0.5±0.15	1.25 ~ 1.55	0.45 ~ 0.55	0.4~0.6
0603	1.6±0.15	0.3±0.2	0.8±0.15	0.8±0.15	1.8 ~ 2.4	0.6 ~ 0.8	0.6 ~ 0.8
0805	2.0(+0.3, -0.1)	0.5±0.3	1.25±0.2	0.85±0.2	2.4 ~ 3.6	0.8 ~ 1.2	0.9 ~ 1.6

All units in mm

FERRITE BEAD EMI SUPPRESSOR SINGLE TYPE - FB SERIES FOR GENERAL SIGNAL LINE

Impedance Frequency Characteristics (Typical)

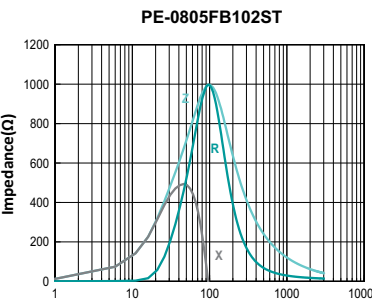
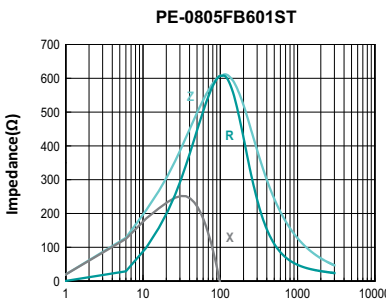
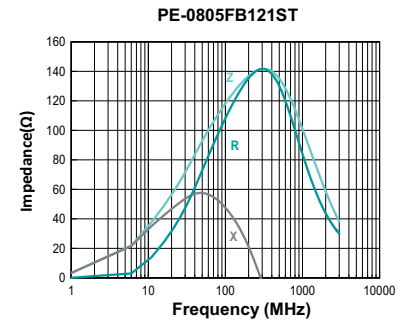
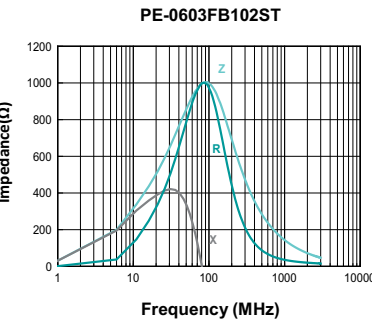
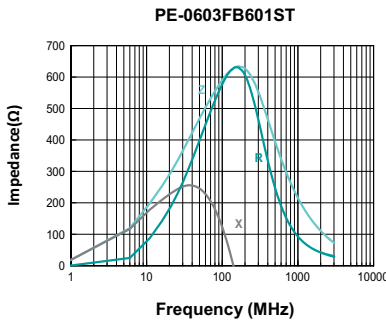
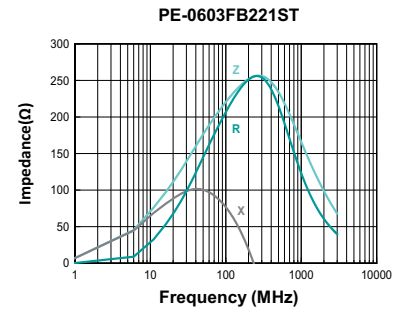
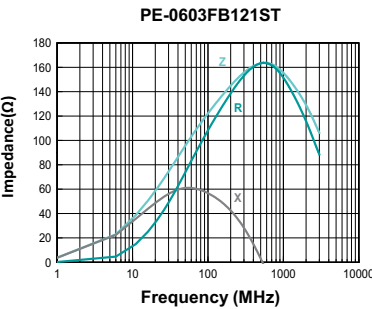
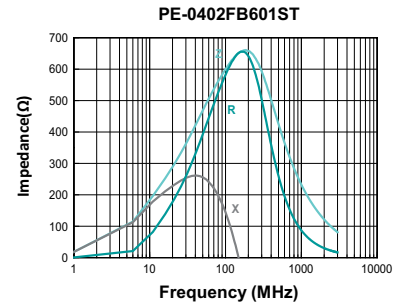
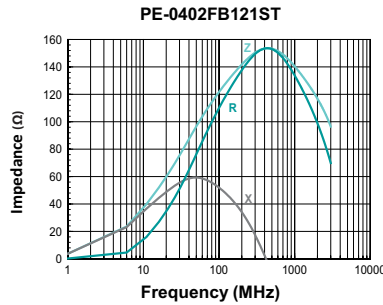
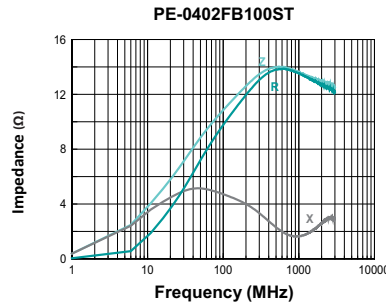

FERRITE BEAD EMI SUPPRESSOR SINGLE TYPE FOR HIGH FREQUENCY APPLICATION



- Ⓟ Signal Line EMI Suppression
- Ⓟ Monolithic inorganic material construction
- Ⓟ Various impedance and frequency application
- Ⓟ High Frequency Giga Hz Application
- Ⓟ Industry Standard package

Electrical Specifications @ 25°C						
Part Number	Impedance (Ω)	Tolerance	Test Frequency (MHz)	Impedance (Ω) 1GHz mini	DC Resistance (Ω) max.	Rated Current (mA) max.
PE-0402HFB221ST	220	±25%	100	250	0.25	700
PE-0402HFB601ST	600	±25%	100	840	0.85	300
PE-0402HFB102ST	1000	±25%	100	1200	1.25	250
PE-0402HFB102STA	1000	±25%	100	900	1.1	250
PE-0402HFB152ST	1500	±25%	100	-	1.50	200
PE-0402HFB182ST	1800	±25%	100	-	2.0	200
PE-0603HFB601ST	600	±25%	100	450	0.35	500
PE-0603HFB102ST	1000	±25%	100	750	1.6	100
		±25%	100	750	1.6	100

Mechanical

PE-XXXXHFB



Unit: mm

PCB LAYOUT



SUGGESTED LAND PATTERN

Dimension:

Imperial Size	A	B	W	T	X	Y	Z
0402	1.0±0.15	0.25±0.1	0.5±0.15	0.5±0.15	1.25~1.55	0.45~0.55	0.45~0.55
0603	1.6±0.15	0.3±0.2	0.8±0.15	0.85±0.2	1.8~2.4	0.6~0.8	0.6~0.8

All units in mm

FERRITE BEAD EMI SUPPRESSOR SINGLE TYPE FOR HIGH FREQUENCY APPLICATION

Impedance Frequency Characteristics (Typical)



FERRITE BEAD EMI SUPPRESSOR SINGLE TYPE FOR POWER LINE APPLICATION



- Ⓢ Power Line EMI Suppression
- Ⓢ Monolithic inorganic material construction
- Ⓢ Various impedance and frequency application
- Ⓢ Industry Standard package

Electrical Specifications @ 25°C

Part Number	Impedance (Ω)	Tolerance	Test Frequency (MHz)	DC Resistance (Ω) max.	Rated Current (mA) max.
PE-0603PFB121ST	120	±25%	100	0.05	2000
PE-0603PFB181ST	180	±25%	100	0.09	1500
PE-0603PFB221ST	220	±25%	100	0.05	2200
PE-0603PFB471ST	470	±25%	100	0.2	1000
PE-0603PFB600ST	60	±25%	100	0.04	3000
PE-0603PFB300ST	30	±25%	100	0.02	5000
PE-0603PFB260ST	26	±25%	100	0.01	6000
PE-0805PFB121ST	120	±25%	100	0.03	3000
PE-0805PFB221ST	220	±25%	100	0.07	2000
PE-0805PFB331ST	330	±25%	100	0.1	1500
PE-0805PFB600ST	60	±25%	100	0.025	3000
PE-1206PFB121ST	120	±25%	100	0.03	3000
PE-1206PFB500ST	50	±25%	100	0.03	3000
PE-1206PFB601ST	600	±25%	100	0.1	2000
PE-1806PFB600ST	60	±25%	100	0.01	6000
PE-1806PFB720ST	72	±25%	100	0.04	6000

Mechanical

PE-XXXXPFB



Unit: mm

PCB LAYOUT

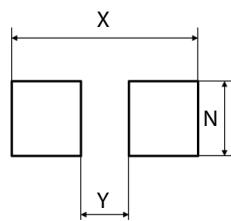

SUGGESTED LAND PATTERN

Imperial Size	A	B	W	T	X	Y	Z
0603	1.6±0.15	0.3±0.2	0.8±0.15	0.85±0.2	1.8~2.4	0.6~0.8	0.6~0.8
0805	2.0 (+0.3, -0.1)	0.5±0.3	1.25±0.2	0.85±0.2	2.4~3.6	0.8~1.2	0.9~1.6
1206	3.2±0.2	0.5±0.3	1.6±0.2	0.85±0.2	3.8~5.5	1.8~2.5	1.2~2.0
1806	4.5±0.2	0.5±0.3	1.6±0.2	1.6±0.2	5.3~6.7	2.4~3.2	0.9~1.6

All units in mm

FERRITE BEAD EMI SUPPRESSOR SINGLE TYPE FOR POWER LINE APPLICATION

Impedance Frequency Characteristics (Typical)

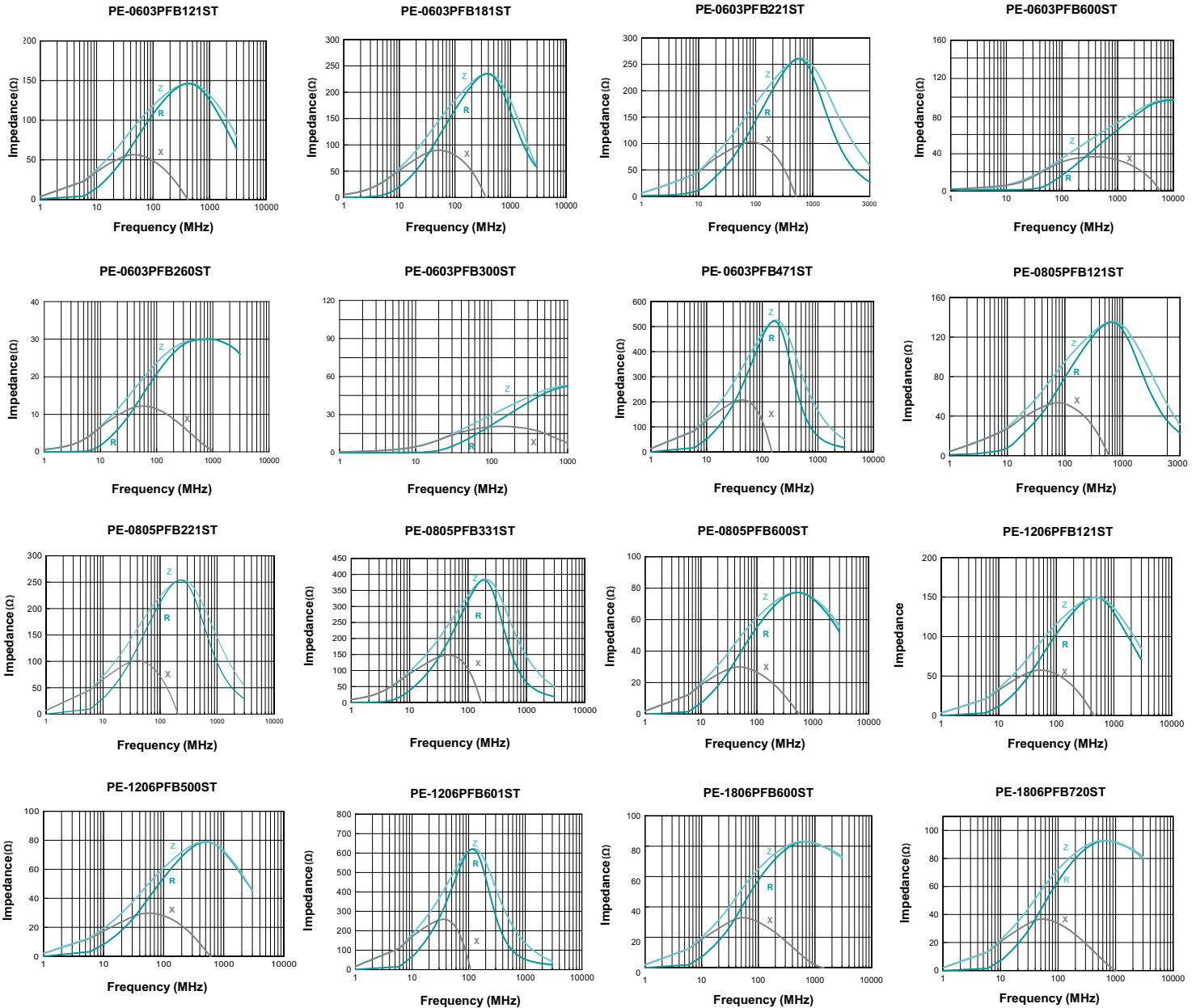

For More Information

Americas - prodinfonetworkamericas@pulseelectronics.com | Europe - comms-Apps-Europe@pulseelectronics.com | Asia - prodinfonetworkapac@pulseelectronics.com

Performance warranty of products offered on this data sheet is limited to the parameters specified. Data is subject to change without notice. Other brand and product names mentioned herein may be trademarks or registered trademarks of their respective owners. © Copyright, 2020, Pulse Electronics, Inc. All rights reserved.

Компания «Life Electronics» занимается поставками электронных компонентов импортного и отечественного производства от производителей и со складов крупных дистрибьюторов Европы, Америки и Азии.

С конца 2013 года компания активно расширяет линейку поставок компонентов по направлению коаксиальный кабель, кварцевые генераторы и конденсаторы (керамические, пленочные, электролитические), за счёт заключения дистрибьюторских договоров

Мы предлагаем:

- Конкурентоспособные цены и скидки постоянным клиентам.
- Специальные условия для постоянных клиентов.
- Подбор аналогов.
- Поставку компонентов в любых объемах, удовлетворяющих вашим потребностям.
- Приемлемые сроки поставки, возможна ускоренная поставка.
- Доставку товара в любую точку России и стран СНГ.
- Комплексную поставку.
- Работу по проектам и поставку образцов.
- Формирование склада под заказчика.
- Сертификаты соответствия на поставляемую продукцию (по желанию клиента).
- Тестирование поставляемой продукции.
- Поставку компонентов, требующих военную и космическую приемку.
- Входной контроль качества.
- Наличие сертификата ISO.

В составе нашей компании организован Конструкторский отдел, призванный помогать разработчикам, и инженерам.

Конструкторский отдел помогает осуществить:

- Регистрацию проекта у производителя компонентов.
- Техническую поддержку проекта.
- Защиту от снятия компонента с производства.
- Оценку стоимости проекта по компонентам.
- Изготовление тестовой платы монтаж и пусконаладочные работы.



Тел: +7 (812) 336 43 04 (многоканальный)
Email: org@lifeelectronics.ru