

AC/DC to Logic Interface Hermetically Sealed Optocouplers

Data Sheet

Description

These devices are single-channel, hermetically sealed, voltage/current threshold detection optocouplers. The products are capable of operation and storage over the full military temperature range and can be purchased as either commercial product, or with full MIL-PRF-38534 Class Level H or K testing, or from the DLA Standard Microcircuit Drawing (SMD) 5962-89477. All devices are manufactured and tested on a MIL-PRF-38534 certified line, and Class H and K devices are included in the DLA Qualified Manufacturers List, QML-38534 for Hybrid Microcircuits.

Each unit contains a light emitting diode (LED), a threshold sensing input buffer IC, and a high gain photon detector to provide an optocoupler that permits adjustable external threshold levels. The input buffer circuit has a nominal turn on threshold of 2.5 mA (I_{TH+}) and 3.6 volts (V_{TH+}). The addition of one or more external attenuation resistors permits the use of this device over a wide range of input voltages and currents. Threshold sensing prior to the LED and detector elements minimizes effects of any variation in optical coupling. Hysteresis is also provided in the buffer for extra noise immunity and switching stability.

The buffer circuit is designed with internal clamping diodes to protect the circuitry and LED from a wide range of overvoltage and overcurrent transients while the diode bridge enables easy use with ac voltage input.

CAUTION It is advised that normal static precautions be taken in handling and assembly of this component to prevent damage and/or degradation which may be induced by ESD.

Features

- Dual marked with device part number and DLA Standard Microcircuit Drawing (SMD)
- Manufactured and tested on a MIL-PRF-38534 certified line
- QML-38534, Class H and K
- Hermetically sealed 8-pin dual in-line packages
- Performance guaranteed over -55°C to $+125^{\circ}\text{C}$
- AC or DC input
- Programmable sense voltage
- Hysteresis
- HCPL-3700 operating compatibility
- Logic compatible output
- 1500 Vdc withstand test voltage
- Thresholds guaranteed over temperature
- Thresholds independent of LED characteristics

Applications

- Military and space
- High reliability systems
- Transportation, medical, and life critical systems
- Limit switch sensing
- Low voltage detector
- AC/DC voltage sensing
- Relay contact monitor
- Relay coil voltage monitor
- Current sensing
- Microprocessor interface
- Telephone ring detection
- Harsh industrial environments

1. See [Selection Guide — Package Styles and Lead Configuration Options](#) for available extensions.

These units combine several unique functions in a single package, providing the user with an ideal component for computer input boards and other applications where a predetermined input threshold optocoupler level is desirable.

The high gain output stage features an open collector output providing both TTL compatible saturation voltages and CMOS compatible breakdown voltages.

This is an 8-pin DIP which may be purchased with a variety of lead bend and plating options. See Selection Guide Table for details. Standard Microcircuit Drawing (SMD) parts are available for each lead style.

Schematic



Note: D₁ and D₂ are Schottky diodes; D₃ and D₄ are zener diodes.

Functional Diagram



Truth Table

Input	Output
H ($V_{TH+} < V_{dc}$) (on)	L
L ($V_{dc} < V_{TH-}$) (off)	H

NOTE The connection of a 0.1- μ F bypass capacitor between pins 8 and 5 is recommended.

Selection Guide — Package Styles and Lead Configuration Options

Part Number and Options	
Commercial	HCPL-5760
MIL-PRF-38534 Class H	HCPL-5761
MIL-PRF-38534 Class K	HCPL-576K
Standard Lead Finish ^a	Gold
Solder Dipped ^b	Option #200
Butt Joint/Gold Plate ^a	Option #100
Gull Wing/Soldered ^b	Option #300
Crew Cut/Gold Plate ^a	Option #600
Class H SMD Part Number	
Prescript for all below	5962-
Gold Plate ^a	8947701PC
Solder Dipped ^b	8947701PA
Butt Joint/Gold Plate ^a	8947701YC
Butt Joint/Soldered ^b	8947701YA
Gull Wing/Soldered ^b	8947701XA
Crew Cut/Gold Plate ^a	Available
Crew Cut/Soldered ^b	Available
Class K SMD Part Number	
Prescript for all below	5962-
Gold Plate ^a	8947702KPC
Solder Dipped ^b	8947702KPA
Butt Joint/Gold Plate ^a	8947702KYC
Butt Joint/Soldered ^b	8947702KYA
Gull Wing/Soldered ^b	8947702KXA
Crew Cut/Gold Plate ^a	Available
Crew Cut/Soldered ^b	Available

- a. Gold Plate lead finish: Maximum gold thickness of leads is <100 micro inches. Typical is 60 to 90 micro inches.
- b. Solder lead finish: Sn63/Pb37.

Absolute Maximum Ratings

Parameter	Symbol	Min	Max	Unit	Notes
Storage Temperature Range	T_S	-65	+150	°C	
Operating Temperature	T_A	-55	+125	°C	
Lead Solder Temperature		—	260 for 10 sec	°C	
Average Input Current	I_{IN}	—	15	mA	a
Surge Input Current	$I_{IN,SG}$	—	140	mA	a, b
Peak Transient Input Current	$I_{IN,PK}$	—	500	mA	a, b
Input Power Dissipation	P_{IN}	—	195	mW	c
Total Package Power Dissipation	P_d	—	260	mW	
Output Power Dissipation	P_O	—	65	mW	
Average Output Current	I_O	—	40	mA	
Supply Voltage (Pins 8 to 5)	V_{CC}	-0.5	20V	min.	
Output Voltage (Pins 6 to 5)	V_O	-0.5	20V	min.	

- a. Current into or out of any single lead.
- b. Surge input current duration is 3 ms at 120 Hz pulse repetition rate. Transient input current duration is 10 μ s at 120-Hz pulse repetition rate. Note that maximum input power, P_{IN} , must be observed.
- c. Derate linearly above 100°C free-air temperature at a rate of 4.26 mW/°C. Maximum input power dissipation of 195 mW allows an input IC junction temperature of 150°C at an ambient temperature of $T_A = 125^\circ\text{C}$ with a typical thermal resistance from junction to ambient of $\theta_{JAi} = 235^\circ\text{C/W}$. The typical thermal resistance from junction to case is equal to 170°C/W. Excessive P_{IN} and T_J can result in device degradation.

ESD Classification

MIL-STD-883, Method 3015	▲▲, Class 2
--------------------------	-------------

Recommended Operating Conditions

Parameter	Symbol	Min	Max	Unit
Power Supply	V_{CC}	3.0	18	V
Operating Frequency ^a	f	0	10	KHz

- a. Maximum operating frequency is defined when output waveform (Pin 6) attains only 90% of V_{CC} with $R_L = 1.8\text{ k}\Omega$, $C_L = 15\text{ pF}$ using a 5V square wave input signal

Outline Drawing

8-Pin DIP Through Hole



Note: Dimensions in millimeters (inches).

Device Marking

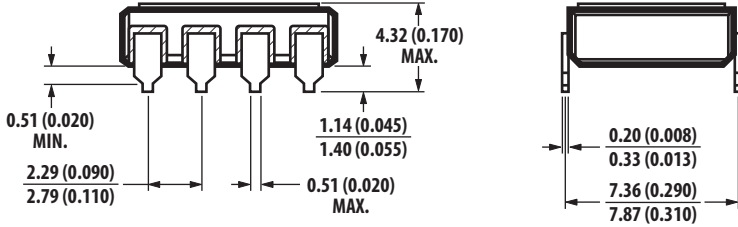
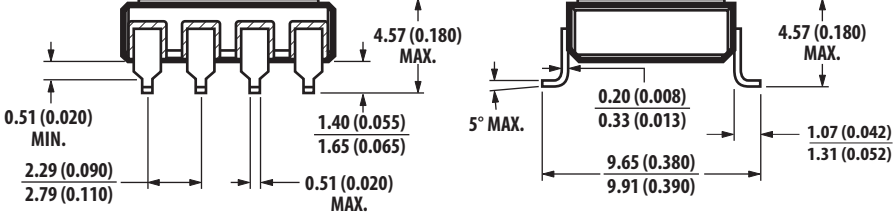
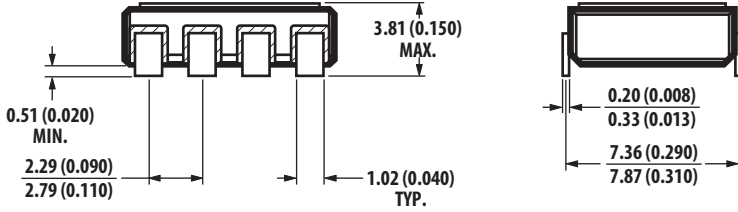

Hermetic Optocoupler Options

Option	Description
100	<p>Surface-mountable hermetic optocoupler with leads trimmed for butt joint assembly. This option is available on Commercial, Class H and Class K product.</p> 
200	<p>Lead finish is solder dipped rather than gold plated. This option is available on Commercial, Class H and Class K product. DLA Drawing (SMD) part numbers contain provisions for lead finish.</p>
300	<p>Surface-mountable hermetic optocoupler with leads cut and bent for gull wing assembly. This option is available on Commercial, Class H and Class K product. This option has solder-dipped leads.</p> 
600	<p>Surface-mountable hermetic optocoupler with leads trimmed for butt joint assembly. This option is available on Commercial, Class H and Class K product. Contact factory for the availability of this option on DLA part types.</p> 

Note: Dimensions in millimeters (inches).

Electrical Characteristics

T_A = -55°C to +125°C, unless otherwise specified.

Parameter	Symbol	Conditions	Group A ^a Subgroup	Min	Typ ^b	Max	Unit	Fig.	Notes
Input Threshold Current	I _{TH+}	V _{IN} = V _{TH+} ; V _{CC} = 4.5V; V _O = 0.4V; I _O ≥ 2.6 mA	1, 2, 3	1.75	2.5	3.20	mA	1, 2	c
	I _{TH-}	V _{IN} = V _{TH-} ; V _{CC} = 4.5V; V _O = 2.4V; I _{OH} ≤ 250 μA	1, 2, 3	0.93	1.3	1.62	mA		
Input Threshold Voltage, DC (Pins 2, 3)	V _{TH+}	V _{IN} = V ₂ - V ₃ ; Pins 1, 4 Open V _{CC} = 4.5V; V _O = 0.4V; I _O ≥ 2.6 mA	1, 2, 3	3.18	3.6	4.10	V		
	V _{TH-}	V _{IN} = V ₂ - V ₃ ; Pins 1, 4 Open V _{CC} = 4.5V; V _O = 2.4V; I _O ≤ 250 μA	1, 2, 3	1.90	2.5	3.00	V		
Input Threshold Voltage, AC (Pins 1, 4)	V _{TH+}	V _{IN} = V ₁ - V ₄ ; Pins 2, 3 Open V _{CC} = 4.5V; V _O = 0.4V; I _O ≥ 2.6 mA	1, 2, 3	3.79	5.0	5.62	V		c, d
	V _{TH-}	V _{IN} = V ₁ - V ₄ ; Pins 2, 3 Open V _{CC} = 4.5V; V _O = 2.4V; I _O ≤ 250 μA	1, 2, 3	2.57	3.7	4.52	V		
Input Clamp Voltage	V _{IHC1}	V _{IHC1} = V ₂ - V ₃ ; V ₃ = GND; I _{IN} = 10 mA; Pin 1, 4 Connected to Pin 3	1, 2, 3	5.3	5.9	7.5	V	3	e
	V _{IHC2}	V _{IHC2} = V ₁ - V ₄ ; I _{IN} = 10 mA; Pins 2, 3 Open	1, 2, 3	6.0	6.6	8.0	V		
	V _{IHC3}	V _{IHC3} = V ₂ - V ₃ ; V ₃ = GND; I _{IN} = 13.5 mA; Pins 1, 4 Open	1, 2, 3	—	12.0	14.0	V		
Input Current	I _{IN}	V _{IN} = V ₂ - V ₃ = 5.0V; Pins 1, 4 Open	1, 2, 3	3.0	3.9	4.5	mA	4	
Logic Low Output Voltage	V _{OL}	V _{CC} = 4.5V; I _{OL} = 2.6 mA	1, 2, 3	—	0.05	0.4	V	4	c
Logic High Output Current	I _{OH}	V _{OH} = V _{CC} = 18V	1, 2, 3	—	—	250	μA		
Logic Low Supply Current	I _{CCL}	V ₂ - V ₃ = 5.0V; V _O = Open; V _{CC} = 18V	1, 2, 3	—	0.8	3.0	mA	5	
Logic High Supply Current	I _{CCH}	V _{CC} = 18V; V _O = Open 45% RH, t = 5s;	1, 2, 3	—	0.001	20	mA		
Input-Output Insulation	I _{I-O}	V _{I-O} = 1500 Vdc; T _A = 25°C	1	—	—	1	μA		f, g
Propagation Delay Time to Logic Low Output Level	t _{PHL}	R _L = 1.8 kΩ, C _L = 15 pF	9, 10, 11	—	4	20	μs	6, 7	h, i
Propagation Delay Time to Logic High Output Level	t _{PLH}	R _L = 1.8 kΩ, C _L = 15 pF	9, 10, 11	—	8	40	μs		h, j
Logic High Common Mode Transient Immunity	CM _H	V _{CM} = 50V, T _A = 25°C, I _{IN} = 0 mA	9	1000	≥10,000	—	V/μs	8	k, l, m
		V _{CM} = 450V, T _A = 25°C, I _{IN} = 0 mA		—	≥10,000	—			
Logic Low Common Mode Transient Immunity	CM _L	V _{CM} = 50V, T _A = 25°C, I _{IN} = 4 mA	9	1000	≥5,000	—	V/μs		
		V _{CM} = 250V, T _A = 25°C, I _{IN} = 4 mA		—	≥5,000	—			

a. Commercial parts receive 100% testing at 25°C (Subgroups 1 and 9). SMD, Class H and Class K parts receive 100% testing at 25°C, 125°C, and -55°C (Subgroups 1 and 9, 2 and 10, 3 and 11, respectively).

b. All typical values are at T_A = 25°C, V_{CC} = 5V unless otherwise noted.

c. Logic low output level at Pin 6 occurs under the conditions of V_{IN} ≥ V_{TH+} as well as the range of V_{IN} > V_{TH-} once V_{IN} has exceeded V_{TH+}. Logic high output level at Pin 6 occurs under the conditions of V_{IN} ≤ V_{TH-} as well as the range of V_{IN} < V_{TH+} once V_{IN} has decreased below V_{TH-}.

d. The AC voltage is instantaneous voltage.

- e. D_1 and D_2 are Schottky diodes; D_3 and D_4 are zener diodes.
- f. Device considered a two-terminal device: Pins 1, 2, 3, 4 connected together, Pins 5, 6, 7, 8 connected together.
- g. This is a momentary withstand test, not an operating condition.
- h. The 1.8-k Ω load represents 1 TTL unit load of 1.6 mA and the 4.7-k Ω pull-up resistor.
- i. The t_{PHL} propagation delay is measured from the 2.5V level of the leading edge of a 5.0V input pulse (1 μ s rise time) to the 1.5V level on the leading edge of the output pulse (see Figure 7).
- j. The t_{PLH} propagation delay is measured from the 2.5V level of the trailing edge of a 5.0V input pulse (1 μ s fall time) to the 1.5V level on the trailing edge of the output pulse (see Figure 7).
- k. Common mode transient immunity in Logic High level is the maximum tolerable dV_{CM}/dt of the common mode voltage, V_{CM} , to ensure that the output remains in a Logic High state (i.e., $V_O > 2.0V$). Common mode transient immunity in Logic Low level is the maximum tolerable dV_{CM}/dt of the common mode voltage, V_{CM} , to ensure that the output remains in a Logic Low state (i.e., $V_O < 0.8V$). See Figure 8.
- l. In applications where dV_{CM}/dt might exceed 50,000 V/ μ s (such as static discharge), a series resistor, R_{CC} , should be included to protect the detector IC from destructively high surge currents. The recommended value for R_{CC} is 240 Ω per volt of allowable drop in V_{CC} (between Pin 8 and V_{CC}) with a minimum value of 240 Ω .
- m. Parameters shall be tested as part of device initial characterization and after process changes. Parameters shall be guaranteed to the limits specified for all lots not specifically tested.

Typical Characteristics

Parameter	Symbol	Typ ^a	Unit	Test Conditions	Fig.	Notes
Hysteresis	I_{HYS}	1.2	mA	$I_{HYS} = I_{TH+} - I_{TH-}$	1	
	V_{HYS}	1.1	V	$V_{HYS} = V_{TH+} - V_{TH-}$		
Input Clamp Voltage	V_{ILC}	-0.76	V	$V_{ILC} = V_2 - V_3; V_3 = GND; I_{IN} = -10$ mA		
Bridge Diode Forward Voltage	$V_{D1,2}$	0.62		$I_{IN} = 3$ mA (see Schematic)		
	$V_{D3,4}$	0.73				
Input-Output Resistance	R_{I-O}	10^{12}	Ω	$V_{I-O} = 500$ Vdc		b
Input-Output Capacitance	C_{I-O}	2.0	pF	$f = 1$ MHz, $V_{I-O} = 0$ Vdc		
Input Capacitance	C_{IN}	50	pF	$f = 1$ MHz; $V_{IN} = 0V$, Pins 2, 3; Pins 1, 4 Open		
Output Rise Time (10% to 90%)	t_r	10	μ s		7	
Output Fall Time (90% to 10%)	t_f	0.5	μ s		7	

- a. All typical values are at $T_A = 25^\circ C$, $V_{CC} = 5V$ unless otherwise noted.
- b. Device considered a two terminal device: Pins 1, 2, 3, 4 connected together, Pins 5, 6, 7, 8 connected together.

Figure 1 Typical Transfer Characteristics



Figure 2 Typical dc Threshold Levels vs. Temperature



Figure 3 Typical Input Characteristics, I_{IN} vs. V_{IN} (AC Voltage Is Instantaneous Value)

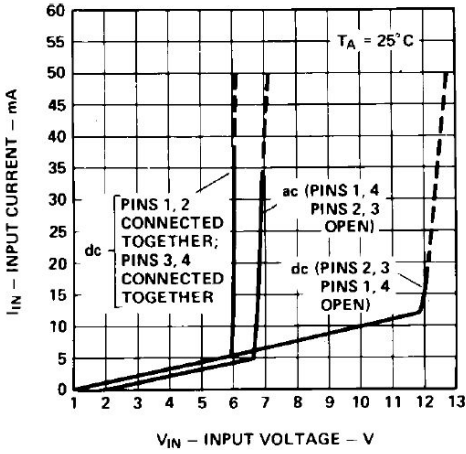

Figure 4 Typical Input Current, I_{IN} , and Low Level Output Voltage, V_{OL} , vs. Temperature



Figure 5 Typical High Level Supply Current, I_{CCH} vs. Temperature



Figure 6 Typical Propagation Delay vs. Temperature



Figure 7 Switching Test Circuit

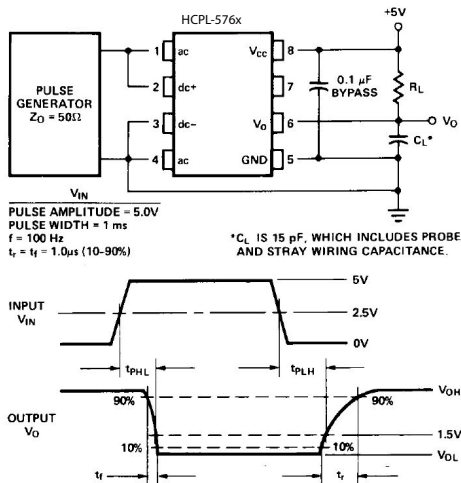
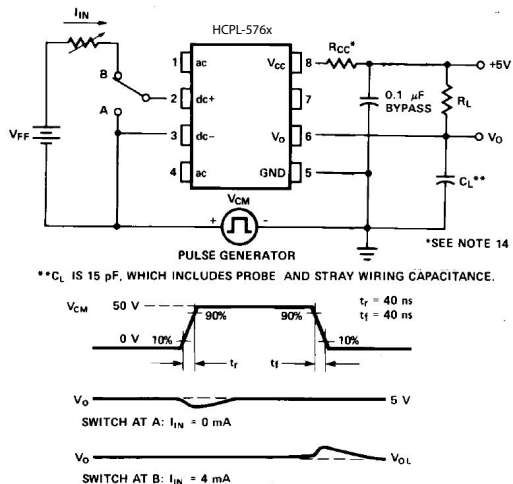

Figure 8 Test Circuit for Common Mode Transient Immunity and Typical Waveforms



Electrical Considerations

The HCPL-5760, HCPL-5761, HCPL-576K, or 5962-89477 optocoupler has internal temperature-compensated, predictable voltage and current threshold points that allow selection of an external resistor, R_x , to determine larger external threshold voltage levels. For a desired external threshold voltage, V_{\pm} , a corresponding typical value of R_x can be obtained from Figure 10. Specific calculation of R_x can be obtained from Equation 1 of Figure 11. Specification of both V_+ and V_- voltage threshold levels simultaneously can be obtained by the use of R_x and R_p as shown in Figure 11 and determined by Equations 2 and 3.

R_x can provide overcurrent transient protection by limiting input current during a transient condition. For monitoring contacts with a relay or switch, the HCPL-5760/1/K, or 5962-89477 combination with R_x and R_p can be used to allow a specific current to be conducted through the contacts for cleaning purposes (wetting current).

The choice of which input voltage clamp level to choose depends upon the application of this device (see Figure 3). It is recommended that the low clamp condition be used when possible to lower the input power dissipation as well as the LED current, which minimizes LED degradation over time.

In applications where dV_{CM}/dt might be extremely large (such as static discharge), a series resistor, R_{CC} , should be connected in series with V_{CC} and Pin 8 to protect the detector IC from destructively high surge currents.¹ In addition, it is recommended that a ceramic disc bypass capacitor of 0.01 μF to 0.1 μF be placed between Pins 8 and 5 to reduce the effect of power supply noise.

For interfacing ac signals to TTL systems, output low-pass filtering can be performed with a pull-up resistor of 1.5 k Ω and 20 μF capacitor. This application requires a Schmitt trigger gate to avoid slow rise time chatter problems. For ac input applications, a filter capacitor can be placed across the dc input terminals for either signal or transient filtering.

Either AC (Pins 1, 4) or DC (Pins 2, 3) input can be used to determine external threshold levels.

For one specifically selected external threshold voltage level V_+ or V_- , R_x can be determined without use of R_p via the following equation.

Equation 1

$$R_x = \frac{V_{+(-)} - V_{TH+(-)}}{I_{TH+(-)}}$$

For two specifically selected external threshold voltage levels, V_+ and V_- , the use of R_x and R_p will permit this selection via equations 2, 3 provided the following conditions are met:

$$\frac{V_+}{V_-} \geq \frac{V_{TH+}}{V_{TH-}} \text{ and } \frac{V_+ - V_{TH+}}{V_- - V_{TH-}} < \frac{I_{TH+}}{I_{TH-}}$$

Equation 2

$$R_x = \frac{V_{TH+}(V_+) - V_{TH+}(V_-)}{I_{TH+}(V_{TH-}) - I_{TH-}(V_{TH+})}$$

Equation 3

$$R_p = \frac{V_{TH+}(V_+) - V_{TH+}(V_-)}{I_{TH+}(V_- - V_{TH-}) - I_{TH-}(V_{TH+} - V_+)}$$

See Application Note 1004 for more information.

1. In applications where dV_{CM}/dt might exceed 50,000 V/ μs (such as static discharge), a series resistor, R_{CC} , should be included to protect the detector IC from destructively high surge currents. The recommended value for R_{CC} is 240 Ω per volt of allowable drop in V_{CC} (between Pin 8 and V_{CC}) with a minimum value of 240 Ω .

Figure 9 Operating Circuit for Burn-in and Steady State Life Tests



Figure 10 Typical External Threshold Characteristic, V_{\pm} vs. R_x



Figure 11 External Threshold Voltage Level Selection

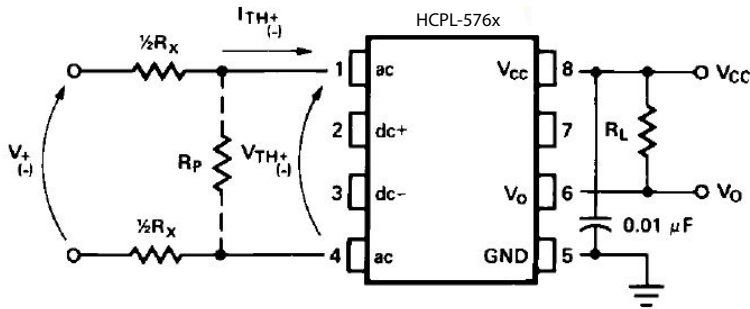

For product information and a complete list of distributors, please go to our web site: www.broadcom.com.

Broadcom, the pulse logo, Connecting everything, Avago Technologies, Avago, and the A logo are among the trademarks of Broadcom in the United States, certain other countries and/or the EU.

Copyright © 2005-2017 Broadcom. All Rights Reserved.

The term "Broadcom" refers to Broadcom Limited and/or its subsidiaries. For more information, please visit www.broadcom.com.

Broadcom reserves the right to make changes without further notice to any products or data herein to improve reliability, function, or design.

Information furnished by Broadcom is believed to be accurate and reliable. However, Broadcom does not assume any liability arising out of the application or use of this information, nor the application or use of any product or circuit described herein, neither does it convey any license under its patent rights nor the rights of others.

AV02-3836EN – February 17, 2017



Компания «Life Electronics» занимается поставками электронных компонентов импортного и отечественного производства от производителей и со складов крупных дистрибьюторов Европы, Америки и Азии.

С конца 2013 года компания активно расширяет линейку поставок компонентов по направлению коаксиальный кабель, кварцевые генераторы и конденсаторы (керамические, пленочные, электролитические), за счёт заключения дистрибьюторских договоров

Мы предлагаем:

- Конкурентоспособные цены и скидки постоянным клиентам.
- Специальные условия для постоянных клиентов.
- Подбор аналогов.
- Поставку компонентов в любых объемах, удовлетворяющих вашим потребностям.
- Приемлемые сроки поставки, возможна ускоренная поставка.
- Доставку товара в любую точку России и стран СНГ.
- Комплексную поставку.
- Работу по проектам и поставку образцов.
- Формирование склада под заказчика.
- Сертификаты соответствия на поставляемую продукцию (по желанию клиента).
- Тестирование поставляемой продукции.
- Поставку компонентов, требующих военную и космическую приемку.
- Входной контроль качества.
- Наличие сертификата ISO.

В составе нашей компании организован Конструкторский отдел, призванный помогать разработчикам, и инженерам.

Конструкторский отдел помогает осуществить:

- Регистрацию проекта у производителя компонентов.
- Техническую поддержку проекта.
- Защиту от снятия компонента с производства.
- Оценку стоимости проекта по компонентам.
- Изготовление тестовой платы монтаж и пусконаладочные работы.



Тел: +7 (812) 336 43 04 (многоканальный)

Email: org@lifeelectronics.ru