



## Main

Range of product	Preventa Safety automation
Product or component type	Safety controller with pre-defined function
Safety module name	XPSMP
Safety module application	2 independent functions
Safety use category	Category 4 maximum conforming to EN/IEC 60954-1
Type of start	Automatic or unmonitored (configuration 1) Automatic or unmonitored (configuration 10) Automatic or unmonitored (configuration 11) Automatic or unmonitored (configuration 14) Automatic or unmonitored (configuration 3) Automatic or unmonitored (configuration 5) Automatic or unmonitored (configuration 7) Monitored (configuration 12) Monitored (configuration 13) Monitored (configuration 15) Monitored (configuration 2) Monitored (configuration 4) Monitored (configuration 6) Monitored (configuration 8) Monitored (configuration 9)
Checks	Configuration (configuration 10) Configuration (configuration 13) Configuration (configuration 3) Configuration (configuration 4) Configuration (configuration 5) Configuration (configuration 6) Configuration (configuration 9)
Standards	DIN V VDE 801 + A1 EN/IEC 60204-1 EN/IEC 60947-1 + A11 EN/IEC 60947-5-1
Product certifications	BIA CSA UL
[Us] rated supply voltage	24 V DC (- 20...20 %)
Connections - terminals	Captive screw clamp terminals: 0.14...0.75 mm <sup>2</sup> , 2 wires flexible without cable end Captive screw clamp terminals: 0.14...0.75 mm <sup>2</sup> , 2 wires solid without cable end Captive screw clamp terminals: 0.14...2.5 mm <sup>2</sup> , 1 wire flexible without cable end Captive screw clamp terminals: 0.14...2.5 mm <sup>2</sup> , 1 wire solid without cable end Captive screw clamp terminals: 0.25...1 mm <sup>2</sup> , 2 wires flexible with cable end, without bezel Captive screw clamp terminals: 0.25...1.5 mm <sup>2</sup> , 1 wire flexible with cable end, with bezel Captive screw clamp terminals: 0.25...2.5 mm <sup>2</sup> , 1 wire flexible with cable end, without bezel Captive screw clamp terminals: 0.5...1.5 mm <sup>2</sup> , 2 wires flexible with cable end, with double bezel
Safety level	Can reach SIL 3 conforming to EN/IEC 62061 Can reach PL e/category 4 conforming to EN/ISO 13849-1

## Complementary

Function of module	Configuration 0: functions disabled (factory setting) Configuration 1: emergency stop monitoring 1-channel wiring, category 2 Configuration 10: enabling grip switch monitoring (3-position switch), category 4 Configuration 11: sensing mat and edges monitoring, category 3 Configuration 12: sensing mat and edges monitoring, category 3 Configuration 13: relay output safety light curtain monitoring, category 4
--------------------	---

The information provided in this documentation contains general descriptions and/or technical characteristics of the performance of the products contained herein. This documentation is not intended as a substitute for and is not to be used for determining suitability or reliability of these products for specific user applications. It is the duty of any such user or integrator to perform the appropriate and complete risk analysis, evaluation and testing of the products with respect to the relevant specific application or use thereof. Neither Schneider Electric Industries SAS nor any of its affiliates or subsidiaries shall be responsible or liable for misuse of the information contained herein.

Configuration 14: coded magnetic switch monitoring, category 4  
 Configuration 15: coded magnetic switch monitoring, category 4  
 Configuration 2: emergency stop monitoring 1-channel wiring, category 2  
 Configuration 3: emergency stop monitoring 2-channel wiring, or guard monitoring, category 4  
 Configuration 4: emergency stop monitoring 2-channel wiring, or guard monitoring, category 4  
 Configuration 5: emergency stop monitoring 2-channel wiring, or guard monitoring, category 4  
 Configuration 6: emergency stop monitoring 2-channel wiring, or guard monitoring, category 4  
 Configuration 7: emergency stop monitoring 2-channel wiring, or guard monitoring, category 4  
 Configuration 8: emergency stop monitoring 2-channel wiring, or guard monitoring, category 4  
 Configuration 9: guard monitoring for injection presses and blowing machines, category 4

Synchronisation time between inputs	0.5 s (configuration 13) 1.5 s (configuration 14) 1.5 s (configuration 15) 1.5 s (configuration 5) 1.5 s (configuration 6) 1.5 s (configuration 9) Unlimited (configuration 3) Unlimited (configuration 4) Unlimited (configuration 7) Unlimited (configuration 8)
Power consumption in W	<= 5 W
Input protection type	Internal, electronic
[Uc] control circuit voltage	24 V
Line resistance	100 Ohm 2000 m
Number of safety circuits	3 NO relays per function (6 NO total), volt-free
Number of additional circuits	3 solid state outputs
Breaking capacity	C300: holding 180 VA AC-15 relay output C300: inrush 1800 VA AC-15 relay output
Breaking capacity	20 mA/24 V for static output circuit 1.5 A/24 V - L/R = 50 ms, DC-13 relay output
Output thermal current	2 A for 1 output and 4 A for the other 2 outputs relay 3.3 A for all 3 outputs relay simultaneously 6 A for 1 output and 2 A for the other 2 outputs relay
[Ith] conventional free air thermal current	<= 20 A
Associated fuse rating	4 A gG relay output conforming to EN/IEC 60947-5-1, DIN VDE 0660 part 200 6 A fast blow relay output conforming to EN/IEC 60947-5-1, DIN VDE 0660 part 200
Minimum output current	10 mA relay output
Minimum output voltage	17 V relay output
Response time on input open	< 30 ms
[Ui] rated insulation voltage	300 V, degree of pollution 2 conforming to EN/IEC 60947-5-1, DIN VDE 0110 parts 1 & 2
[Uimp] rated impulse withstand voltage	4 kV overvoltage category III conforming to EN/IEC 60947-5-1, DIN VDE 0110 parts 1 & 2
Local signalling	12 LEDs
Mounting support	35 mm symmetrical DIN rail
Depth	4.49 in (114 mm)
Height	3.9 in (99 mm)
Width	1.77 in (45 mm)
Product weight	0.71 lb(US) (0.32 kg)

## Environment

IP degree of protection	IP20 (terminals) IP40 (enclosure)
ambient air temperature for operation	14...131 °F (-10...55 °C)
ambient air temperature for storage	-13...185 °F (-25...85 °C)

## Offer Sustainability

WARNING: This product can expose you to chemicals      WARNING: This product can expose you to chemicals including:

including:

Lead and lead compounds, which is known to the State of California to cause cancer and birth defects or other reproductive harm.

For more information go to [www.p65warnings.ca.gov](http://www.p65warnings.ca.gov)

### Contractual warranty

Warranty period 18 months

### Dimensions

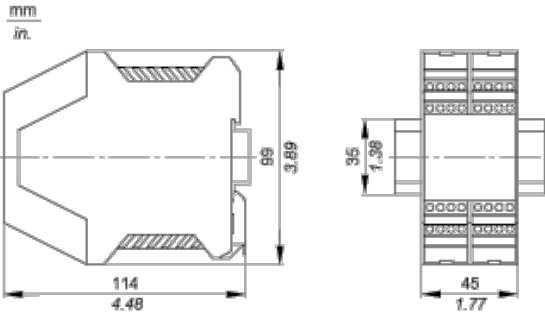

### Wiring Diagrams

#### Refer to the Instruction Sheet

To download the instruction sheet, follow below procedure:



**XPSAC5121**  
module XPSAC - Emergency stop - 24 V AC DC  
[Download XPSAC5121 product datasheet](#)

Discover XPSAC5121 by

- Characteristics
- Dimensions Drawings
- Connections and Schema
- Technical Description
- Download & Documents**

Download & Documents 1 to 3 of 3 (Total: -1)

Instruction sheet		
XPSAC... Safety module for emergency stop and switch monitoring	English 2012-07-04	pdf (29)
Image of product		
Emergency stop and switch monitoring	2010-11-10	[Select]
Certificate		
Russian certificate	English 2010-07-07	pdf (60)



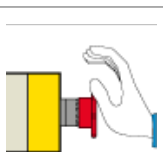

① ②

- 1 Click on **Download & Documents**.
- 2 Click on **Instruction sheet**.

### Safety Functions

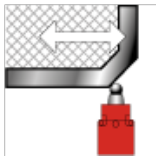

- Emergency stop monitoring, 1 channel wiring:
  - 1 channel Emergency stop, automatic or unmonitored start.
  - 1 channel Emergency stop, monitored start.
- Emergency stop monitoring, 2 channel wiring:
  - 2 channel Emergency stop, automatic or unmonitored start.
  - 2 channel Emergency stop, monitored start.

	<ul style="list-style-type: none"> <li>  Coded magnetic switch monitoring: <ul style="list-style-type: none"> <li>  Automatic or unmonitored start, synchronization time = 1,5 s.</li> <li>  Monitored start, synchronization time = 1,5 s.</li> </ul> </li> </ul>
	<ul style="list-style-type: none"> <li>  Guard monitoring with start test: <ul style="list-style-type: none"> <li>  Locking of guard with start test, automatic or unmonitored start.</li> <li>  Locking of guard with start test, monitored start.</li> </ul> </li> <li>  Guard monitoring with start test and synchronization time = 1,5 ms: <ul style="list-style-type: none"> <li>  Locking of guard with start test, automatic or unmonitored start.</li> <li>  Locking of guard with start test, monitored start.</li> </ul> </li> <li>  Guard monitoring for injection press or blowing machine.</li> </ul>
	<ul style="list-style-type: none"> <li>  Enabling switch monitoring, safety mat monitoring: <ul style="list-style-type: none"> <li>  Enabling switch monitoring, with or without start-up preparation.</li> <li>  Safety mat monitoring, automatic or unmonitored start.</li> </ul> </li> </ul>
	<ul style="list-style-type: none"> <li>  Sensing mat monitoring, monitored start.</li> </ul>
	<ul style="list-style-type: none"> <li>  Light curtain monitoring, monitored start, synchronization time = 0,5 s.</li> </ul>

Компания «Life Electronics» занимается поставками электронных компонентов импортного и отечественного производства от производителей и со складов крупных дистрибьюторов Европы, Америки и Азии.

С конца 2013 года компания активно расширяет линейку поставок компонентов по направлению коаксиальный кабель, кварцевые генераторы и конденсаторы (керамические, пленочные, электролитические), за счёт заключения дистрибьюторских договоров

Мы предлагаем:

- Конкурентоспособные цены и скидки постоянным клиентам.
- Специальные условия для постоянных клиентов.
- Подбор аналогов.
- Поставку компонентов в любых объемах, удовлетворяющих вашим потребностям.
- Приемлемые сроки поставки, возможна ускоренная поставка.
- Доставку товара в любую точку России и стран СНГ.
- Комплексную поставку.
- Работу по проектам и поставку образцов.
- Формирование склада под заказчика.
- Сертификаты соответствия на поставляемую продукцию (по желанию клиента).
- Тестирование поставляемой продукции.
- Поставку компонентов, требующих военную и космическую приемку.
- Входной контроль качества.
- Наличие сертификата ISO.

В составе нашей компании организован Конструкторский отдел, призванный помогать разработчикам, и инженерам.

Конструкторский отдел помогает осуществить:

- Регистрацию проекта у производителя компонентов.
- Техническую поддержку проекта.
- Защиту от снятия компонента с производства.
- Оценку стоимости проекта по компонентам.
- Изготовление тестовой платы монтаж и пусконаладочные работы.



Тел: +7 (812) 336 43 04 (многоканальный)

Email: [org@lifeelectronics.ru](mailto:org@lifeelectronics.ru)