

Product Overview

The QPD1019 is a 500 W (P_{3dB}) internally matched discrete GaN on SiC HEMT which operates from 2.9 to 3.3 GHz on a 50V supply rail. The device is GaN IMFET fully matched to 50 Ω in an industry standard air cavity package and is ideally suited for military radar.

RoHS compliant

Evaluation boards are available upon request.



17.40 x 24.00 x 4.31 mm

Functional Block Diagram

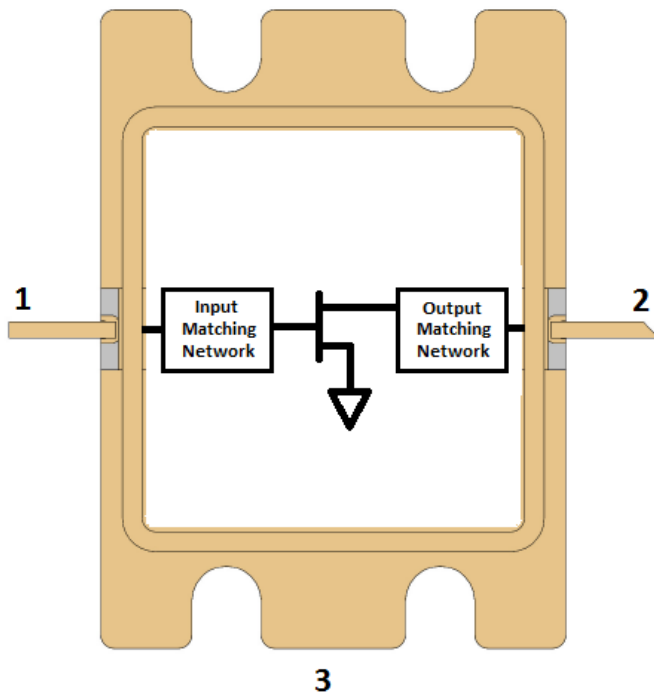

- Frequency: 2.9 to 3.3 GHz
- Output Power (P_{3dB})¹: 590 W
- Linear Gain¹: 15.5 dB
- Typical $DEFF_{3dB}$ ¹: 69%
- Operating Voltage: 50 V
- Low thermal resistance package
- Pulse capable

Note 1: @ 3.1 GHz

Applications

- Military radar
- Civilian radar
- Test instrumentation

Ordering

Part No.	Description
QPD1019	Tray of 18 QPD1019
QPD1019S2	Pack of 2 QPD1019
QPD1019EVB01	2.9 – 3.3 GHz EVB



QPD1019

500W, 50V, 2.9 – 3.3 GHz, GaN RF IMFET

Absolute Maximum Ratings¹

Parameter	Rating	Units
Breakdown Voltage, BV_{DG}	+150	V
Gate Voltage Range, V_G	-7 to +2	V
Drain Current	20	A
Gate Current Range, I_G	See page 4.	mA
Power Dissipation, 10% DC 100 uS PW, P_D , $T = 85^\circ\text{C}$	522	W
RF Input Power, 10% DC 100 uS PW, 3.1 GHz, $T = 25^\circ\text{C}$	+49	dBm
Mounting Temperature (30 Seconds)	320	$^\circ\text{C}$
Storage Temperature	-65 to +150	$^\circ\text{C}$

Notes:

1. Operation of this device outside the parameter ranges given above may cause permanent damage.

Recommended Operating Conditions¹

Parameter	Min	Typ	Max	Units
Operating Temp. Range	-40	+25	+85	$^\circ\text{C}$
Drain Voltage Range, V_D	+28	+50	+55	V
Drain Bias Current, I_{DQ}	-	750	-	mA
Drain Current, I_D^3	-	15	-	A
Gate Voltage, V_G^4	-	-2.8	-	V
Power Dissipation, Pulsed (P_D) ^{2, 3}	-	-	469	W

Notes:

1. Electrical performance is measured under conditions noted in the electrical specifications table. Specifications are not guaranteed over all recommended operating conditions.
2. Package base at 85°C
3. Pulse Width = 100 uS, Duty Cycle = 10%
4. To be adjusted to desired I_{DQ}

Pulsed Characterization – Load-Pull Performance – Power Tuned¹

Parameters	Typical Values			Unit
Frequency, F	2.9	3.1	3.3	GHz
Linear Gain, G_{LIN}	15.5	15.5	15.8	dB
Output Power at 3dB compression point, P_{3dB}	57.7	57.7	57.5	dBm
Drain Efficiency at 3dB compression point, $DEFF_{3dB}$	62.3	60.5	60.0	%
Gain at 3dB compression point	12.5	13.5	12.8	dB

Notes:

1. Test conditions unless otherwise noted: $V_D = +50\text{ V}$, $I_{DQ} = 750\text{ mA}$, $\text{Temp} = 25^\circ\text{C}$, 100 uS PW, 10% DC

Pulsed Characterization – Load-Pull Performance – Efficiency Tuned¹

Parameters	Typical Values			Unit
Frequency, F	3.1	3.3	3.3	GHz
Linear Gain, G_{LIN}	16.1	17.5	16.7	dB
Output Power at 3dB compression point, P_{3dB}	56.4	55.9	56.1	dBm
Drain Efficiency at 3dB compression point, $DEFF_{3dB}$	69.5	69.3	66.0	%
Gain at 3dB compression point, G_{3dB}	13.1	14.5	13.7	dB

Notes:

1. Test conditions unless otherwise noted: $V_D = +50\text{ V}$, $I_{DQ} = 750\text{ mA}$, $\text{Temp} = 25^\circ\text{C}$, 100 uS PW, 10% DC

RF Characterization – 2.9 – 3.3 GHz EVB Performance At 2.9 GHz¹

Parameter	Min	Typ	Max	Units
Linear Gain, G_{LIN}	–	15.5	–	dB
Output Power at 3dB compression point, P_{3dB}	–	57.0	–	dBm
Drain Efficiency at 3dB compression point, $DEFF_{3dB}$	–	65.8	–	%
Gain at 3dB compression point, G_{3dB}	–	12.5	–	dB

Notes:

1. $V_D = +50\text{ V}$, $I_{DQ} = 750\text{ mA}$, Temp = 25°C, 100 uS PW, 10% DC

RF Characterization – 2.9 – 3.3 GHz EVB Performance At 3.1 GHz¹

Parameter	Min	Typ	Max	Units
Linear Gain, G_{LIN}	–	16.3	–	dB
Output Power at 3dB compression point, P_{3dB}	–	57.0	–	dBm
Drain Efficiency at 3dB compression point, $DEFF_{3dB}$	–	62.3	–	%
Gain at 3dB compression point, G_{3dB}	–	13.3	–	dB

Notes:

1. $V_D = +50\text{ V}$, $I_{DQ} = 750\text{ mA}$, Temp = 25°C, 100 uS PW, 10% DC

RF Characterization – 2.9 – 3.3 GHz EVB Performance At 3.3 GHz¹

Parameter	Min	Typ	Max	Units
Linear Gain, G_{LIN}	–	16.3	–	dB
Output Power at 3dB compression point, P_{3dB}	–	56.4	–	dBm
Drain Efficiency at 3dB compression point, $DEFF_{3dB}$	–	65.1	–	%
Gain at 3dB compression point, G_{3dB}	–	13.3	–	dB

Notes:

1. $V_D = +50\text{ V}$, $I_{DQ} = 750\text{ mA}$, Temp = 25°C, 100 uS PW, 10% DC

RF Characterization – Mismatch Ruggedness at 2.9, 3.1 & 3.3 GHz¹

Symbol	Parameter	dB Compression	Typical
VSWR	Impedance Mismatch Ruggedness	3	10:1

Notes:

1. Test conditions unless otherwise noted: $T_A = 25^\circ\text{C}$, $V_D = 50\text{ V}$, $I_{DQ} = 750\text{ mA}$, 100 uS PW, 10% DC.
2. Driving input power is determined at pulsed compression under matched condition at EVB output connector.
3. No spur detected down to the noise floor of Spectrum Analyzer from 0.01 – 8GHz at $T_A = -40^\circ\text{C}$.

Maximum Gate Current

Maximum Gate Current Vs. Peak IR Surface Temperature

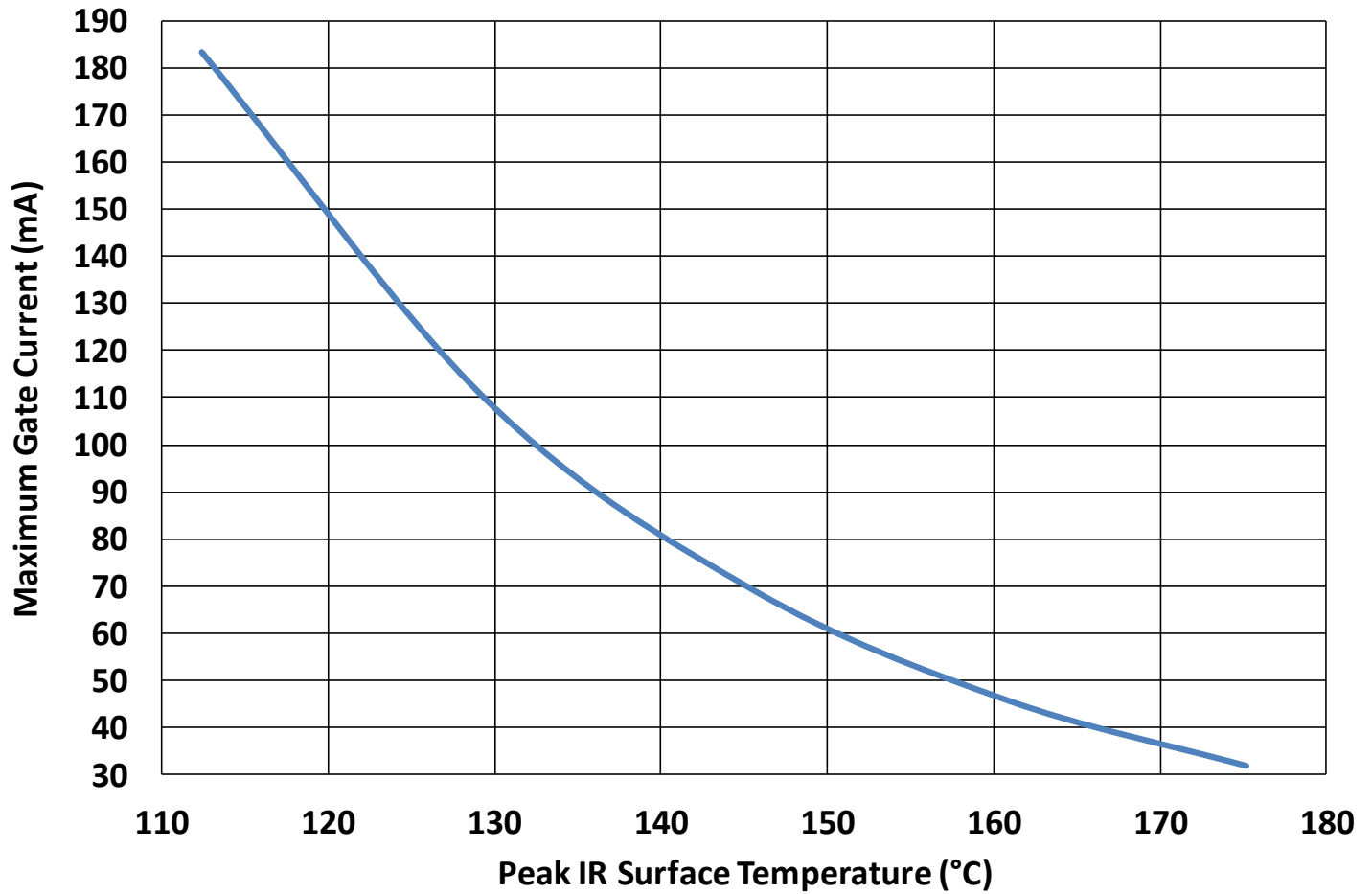

Thermal and Reliability Information – Pulsed

Peak IR Surface Temperature vs. Pulse Width
 Package Base Fixed at 85 °C

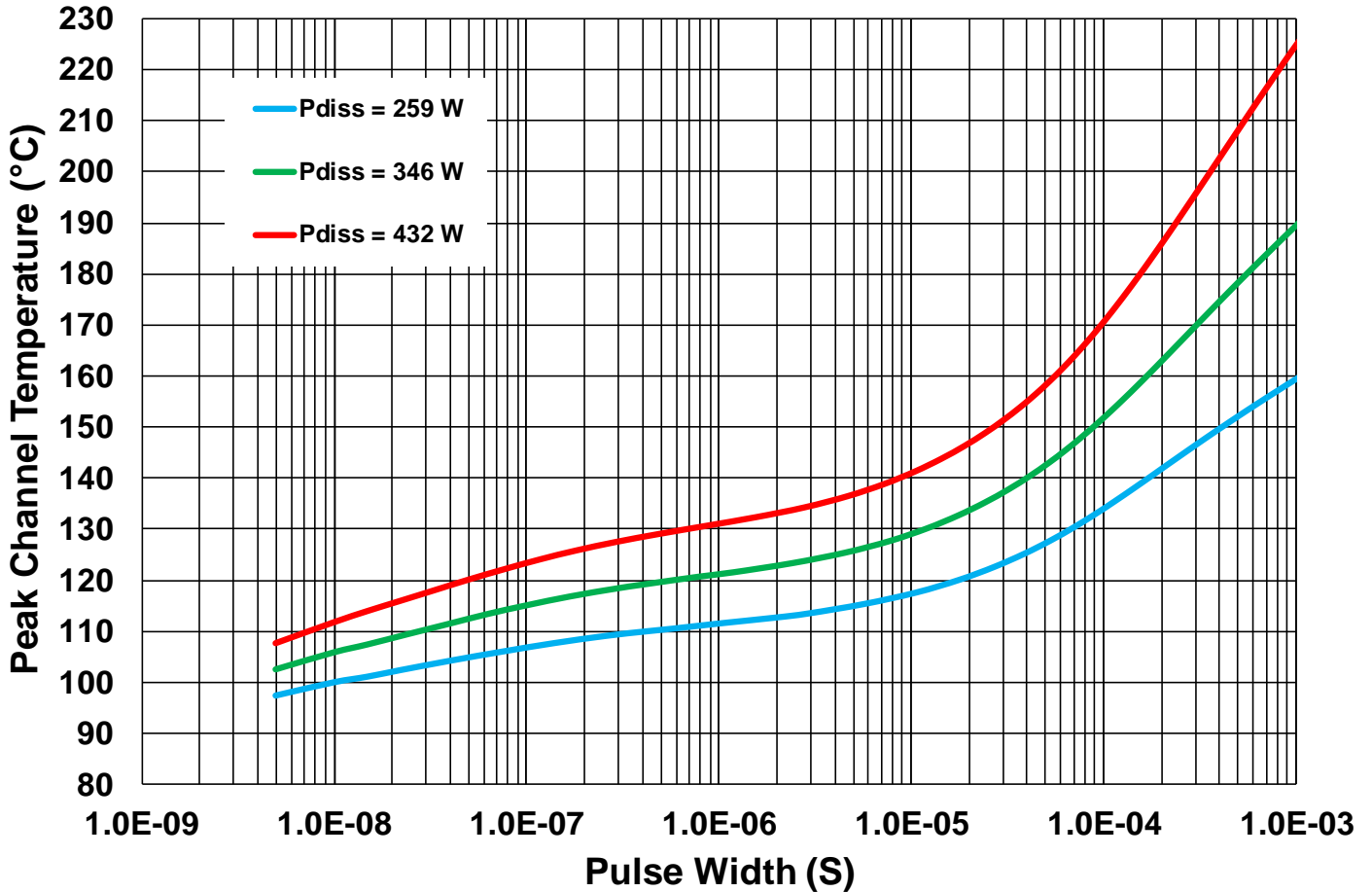

Parameter	Conditions	Values	Units
Thermal Resistance, IR ¹ (θ_{JC})	85°C back side temperature	0.19	°C/W
Peak IR Surface Temperature ¹ (T_{CH})	259 W Pdiss, 100 uS PW, 10% DC	134	°C
Thermal Resistance, IR ¹ (θ_{JC})	85°C back side temperature	0.19	°C/W
Peak IR Surface Temperature ¹ (T_{CH})	346 W Pdiss, 100 uS PW, 10% DC	152	°C
Thermal Resistance, IR ¹ (θ_{JC})	85°C back side temperature	0.20	°C/W
Peak IR Surface Temperature ¹ (T_{CH})	432 W Pdiss, 100 uS PW, 10% DC	170	°C

¹Refer to the following document [GaN Device Channel Temperature, Thermal Resistance, and Reliability Estimates](#)

Load-Pull Smith Charts^{1,2}

Notes:

1. $V_D = 50\text{ V}$, $I_{DQ} = 750\text{ mA}$, $100\text{ }\mu\text{S PW}$, 10% DC pulsed. Performance is at 3dB gain compression referenced to peak gain.
2. See page 13 for load-pull and source-pull reference planes. $50\text{-}\Omega$ load-pull TRL fixtures are built with 20-mil RO4350B material.

2.9GHz, Load-pull

$Z_s(1f_0) = 50\Omega$
 $Z_s(2f_0) = 49.96+24i\Omega$
 $Z_s(3f_0) = 16.7+0.11i\Omega$

- Max Power is 57.7dBm at $Z = 43.526-11.413i\Omega$
 $\Gamma = -0.0535-0.1286i$
- Max Gain is 13.6dB at $Z = 72.284+38.391i\Omega$
 $\Gamma = 0.2556+0.2337i$
- Max DEff is 69.5% at $Z = 38.299+18.634i\Omega$
 $\Gamma = -0.0842+0.2288i$

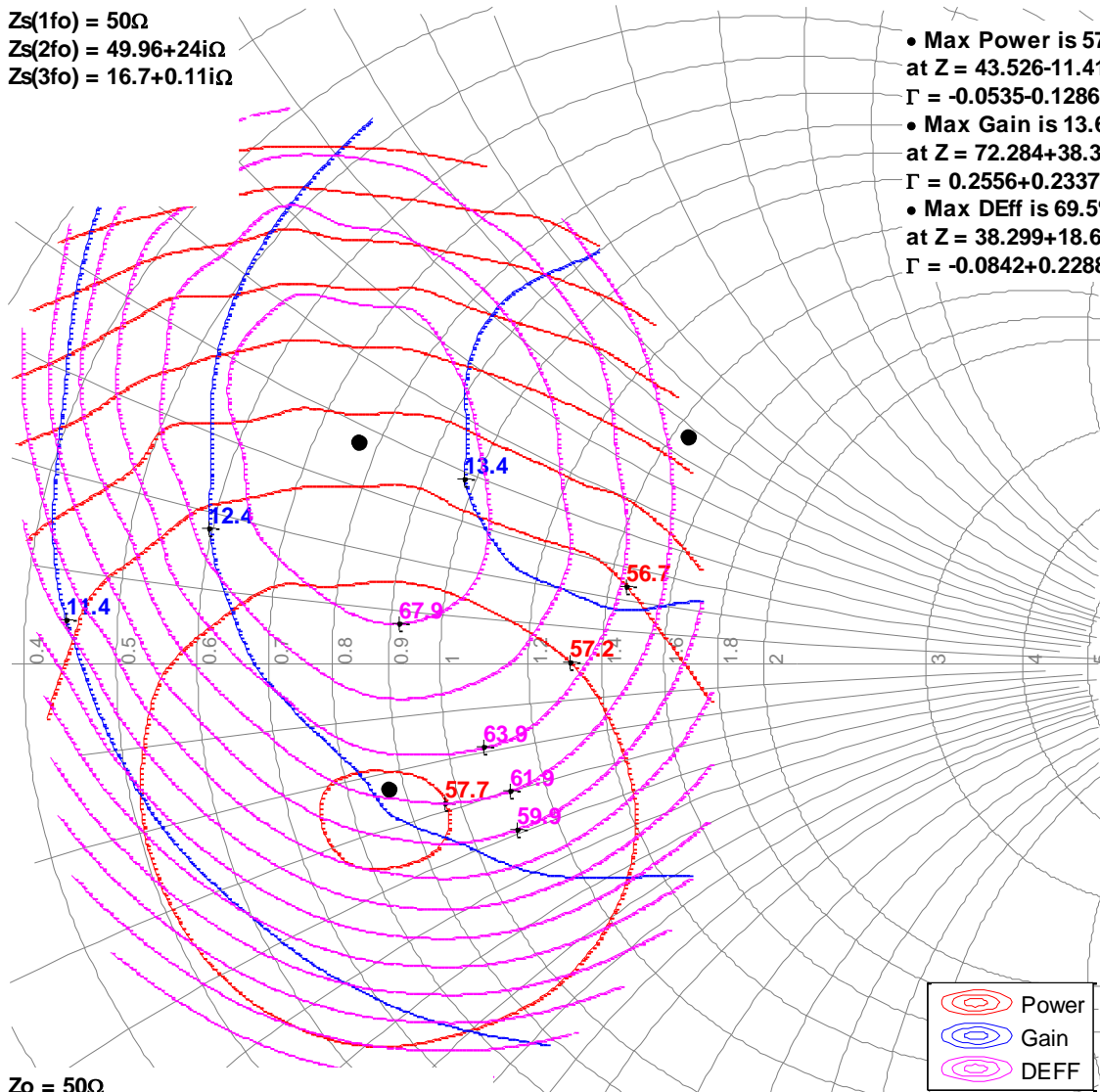

$Z_0 = 50\Omega$
 3dB Compression Referenced to Peak Gain

Load-Pull Smith Charts^{1, 2}

Notes:

1. $V_D = 50\text{ V}$, $I_{DQ} = 750\text{ mA}$, $100\text{ }\mu\text{s PW}$, 10% DC pulsed. Performance is at 3dB gain compression referenced to peak gain.
2. See page 13 for load-pull and source-pull reference planes. $50\text{-}\Omega$ load-pull TRL fixtures are built with 20-mil RO4350B material.

3.1GHz, Load-pull

$Z_s(1fo) = 50.01 - 0.01i\Omega$
 $Z_s(2fo) = 70.27 - 11.24i\Omega$
 $Z_s(3fo) = 239.74 - 129.83i\Omega$
 $Z_l(3fo) = 70.51 + 73.61i\Omega$

- Max Power is 57.7dBm at $Z = 45.594 - 24.684i\Omega$
 $\Gamma = 0.0193 - 0.2532i$
- Max Gain is 14.8dB at $Z = 29.914 + 12.772i\Omega$
 $\Gamma = -0.2202 + 0.195i$
- Max DEff is 69.3% at $Z = 25.975 - 0.01i\Omega$
 $\Gamma = -0.3162 - 0.0002i$

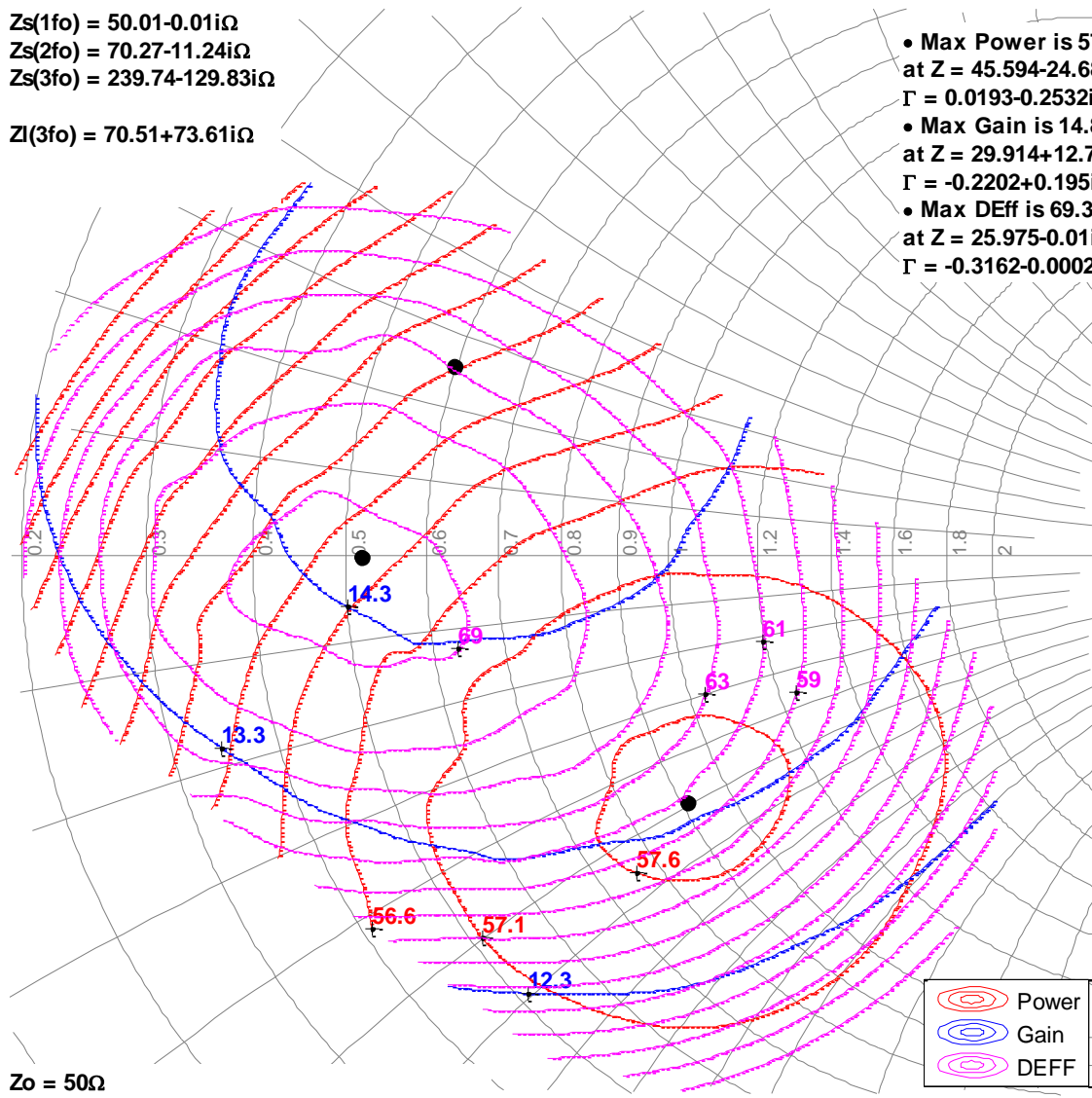

$Z_0 = 50\Omega$
 3dB Compression Referenced to Peak Gain

Load-Pull Smith Charts^{1, 2, 3}

Notes:

1. $V_D = 50\text{ V}$, $I_{DQ} = 750\text{ mA}$, $100\text{ }\mu\text{s PW}$, 10% DC pulsed. Performance is at 3dB gain compression referenced to peak gain.
2. See page 13 for load-pull and source-pull reference planes. $50\text{-}\Omega$ load-pull TRL fixtures are built with 20-mil RO4350B material.

3.3GHz, Load-pull

$Z_s(1fo) = 50.02 + 0.07i\Omega$
 $Z_s(2fo) = 47.87 - 14.87i\Omega$
 $Z_s(3fo) = 20.98 - 24.59i\Omega$
 $Z_l(3fo) = 37.52 - 21.65i\Omega$

- Max Power is 57.5dBm at $Z = 72.195 - 22.276i\Omega$
 $\Gamma = 0.208 - 0.1444i$
- Max Gain is 13.8dB at $Z = 30.218 - 6.755i\Omega$
 $\Gamma = -0.2378 - 0.1042i$
- Max DEff is 66% at $Z = 35.517 - 22.265i\Omega$
 $\Gamma = -0.0951 - 0.2851i$

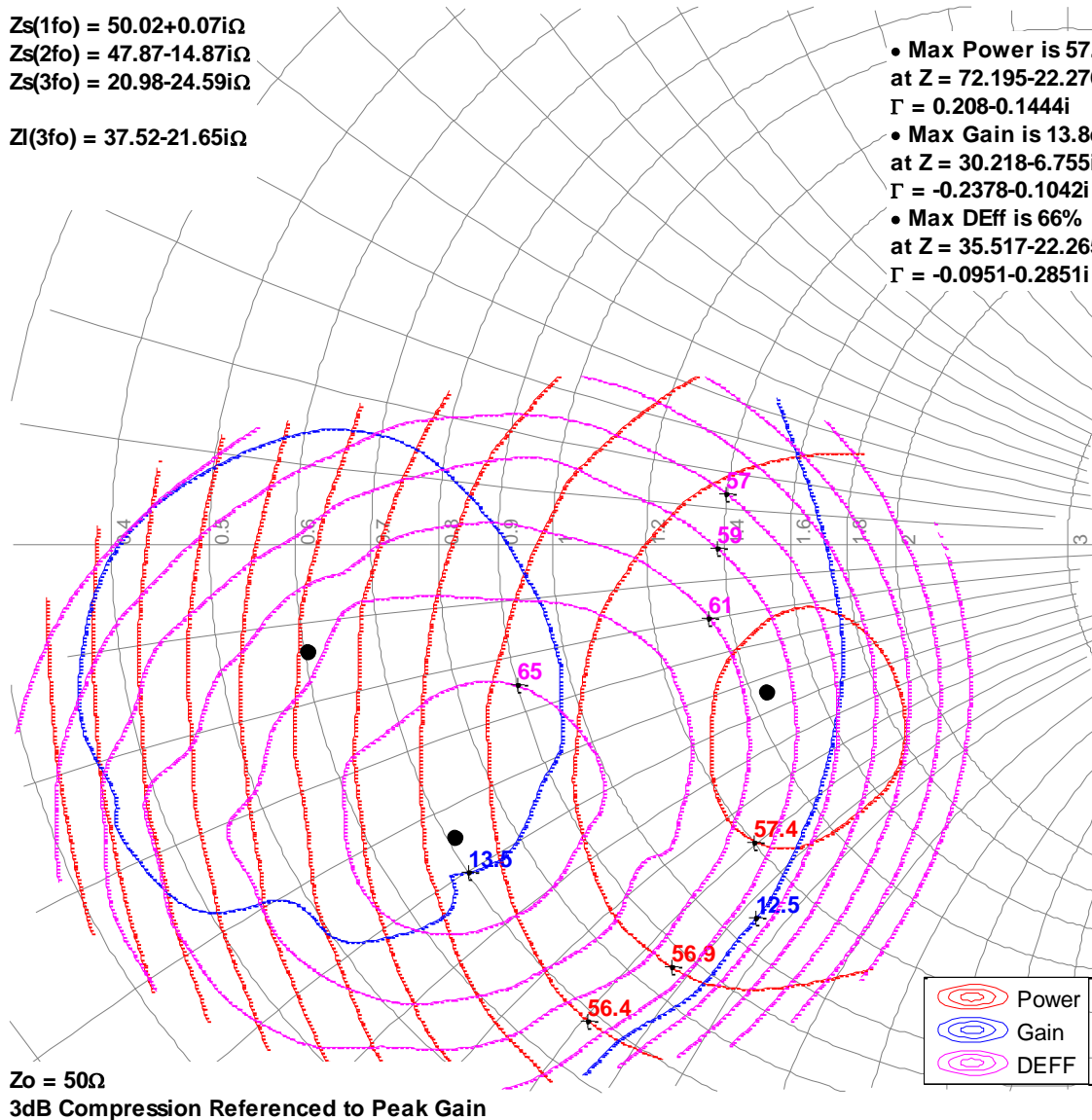

Typical Performance – Load-Pull Drive-up^{1,2}

Notes:

1. 100 uS PW, 10% DC pulsed signal, $V_D = 50\text{ V}$, $I_{DQ} = 750\text{ mA}$, $T_A = 25^\circ\text{C}$.
2. See page 13 for load-pull and source-pull reference planes where the performance was measured.

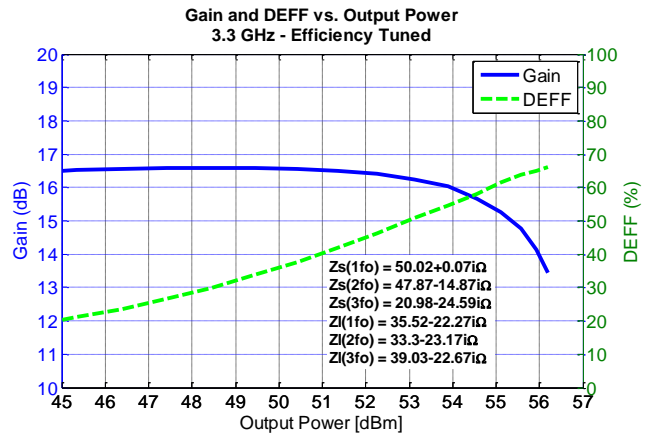
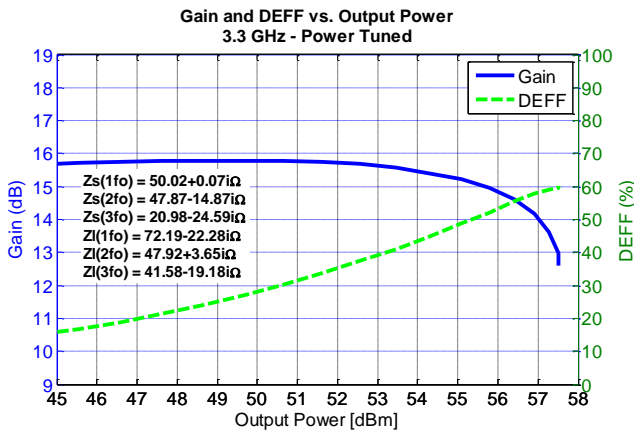
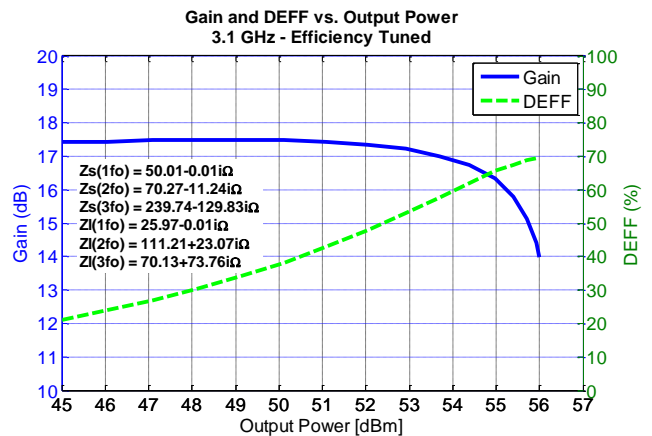
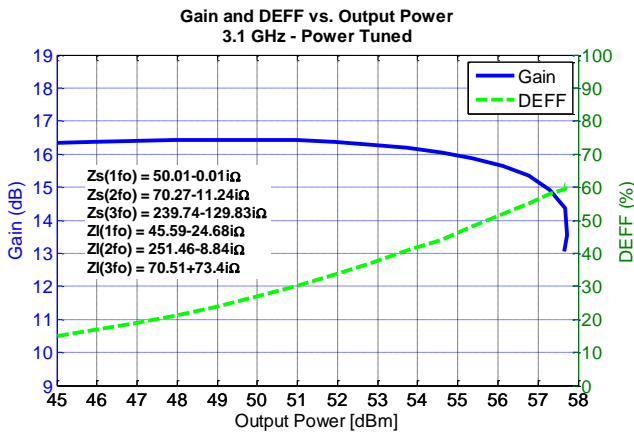
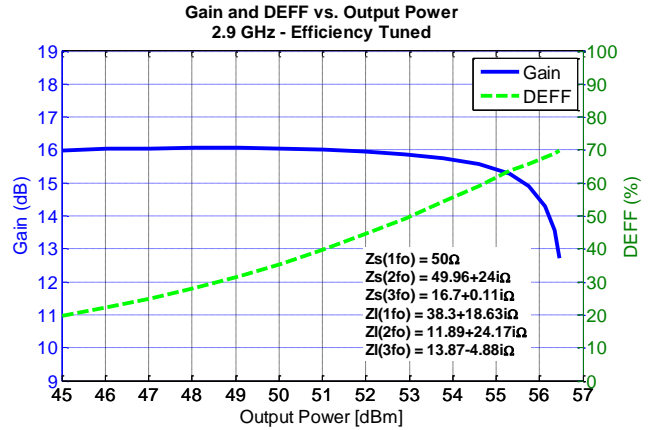
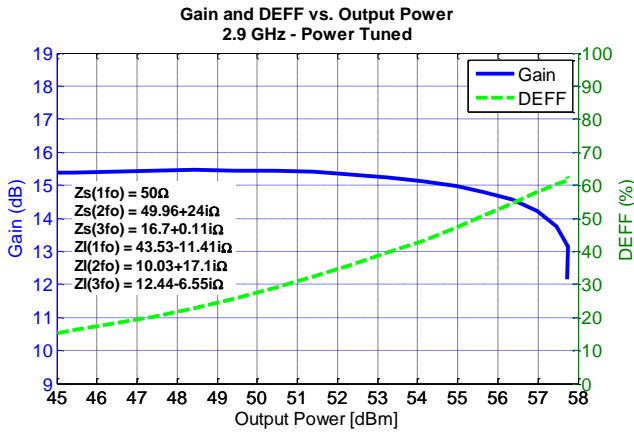

Power Drive-up Performance Over Temperatures Of 2.9 – 3.3 GHz EVB^{1, 2}

Notes:

1. $V_D = 50\text{ V}$, $I_{DQ} = 750\text{ mA}$, $100\text{ }\mu\text{S PW}$, $10\%\text{ DC}$.
2. Performance shown is at EVB connectors reference plane.

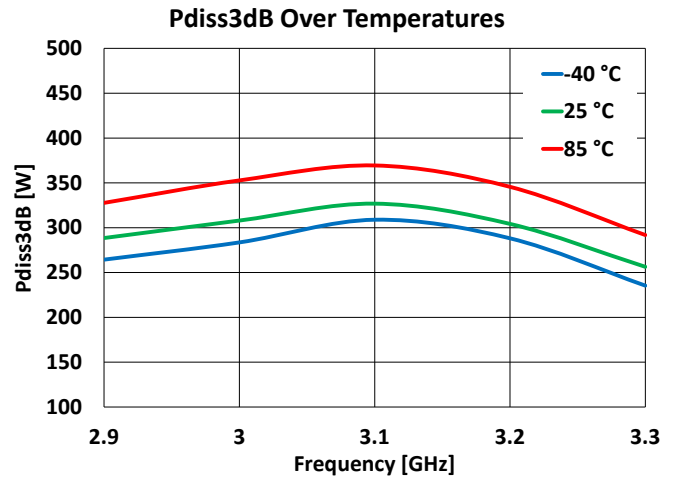
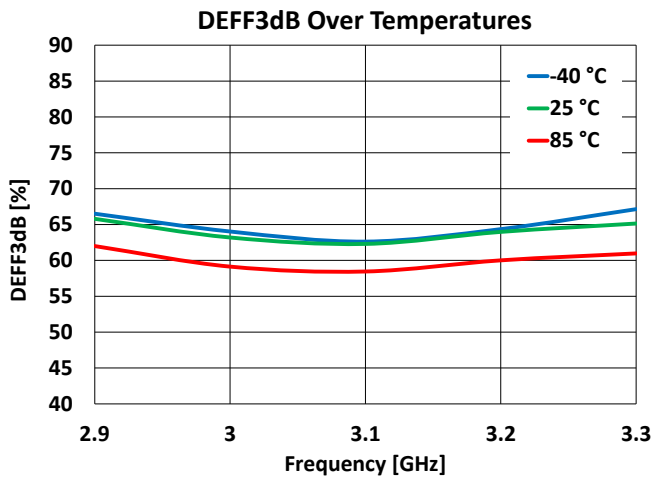
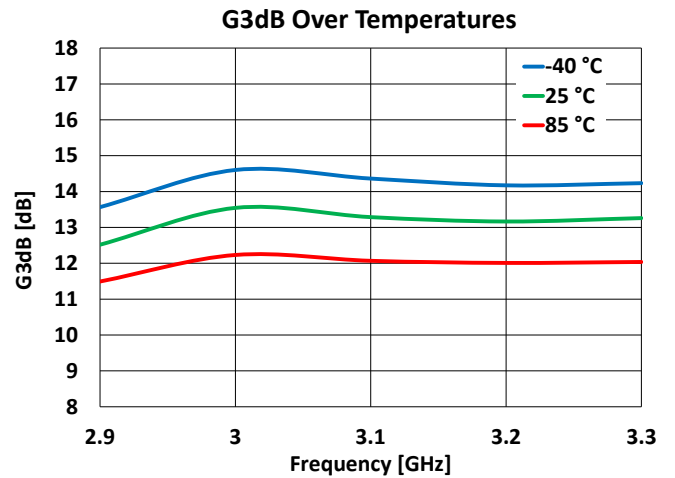
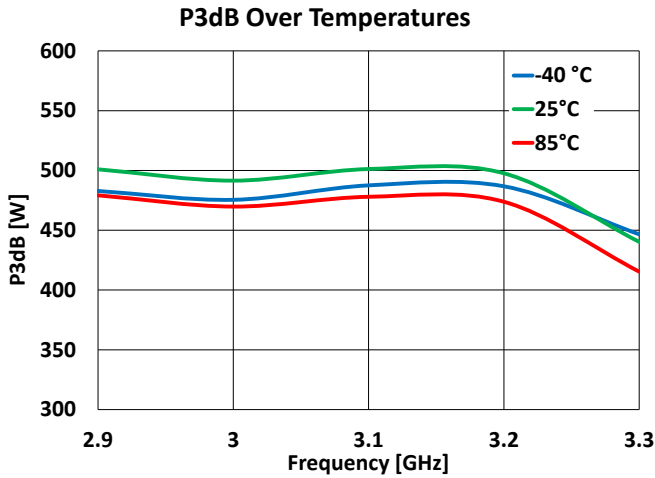

Power Drive-up Performance At 25°C Of 2.9 – 3.3 GHz EVB^{1,2}

Notes:

1. $V_D = 50\text{ V}$, $I_{DQ} = 750\text{ mA}$, $100\text{ }\mu\text{S PW}$, $10\%\text{ DC}$, $T_A = 25^\circ\text{C}$.
2. Performance shown is at EVB connectors reference plane.

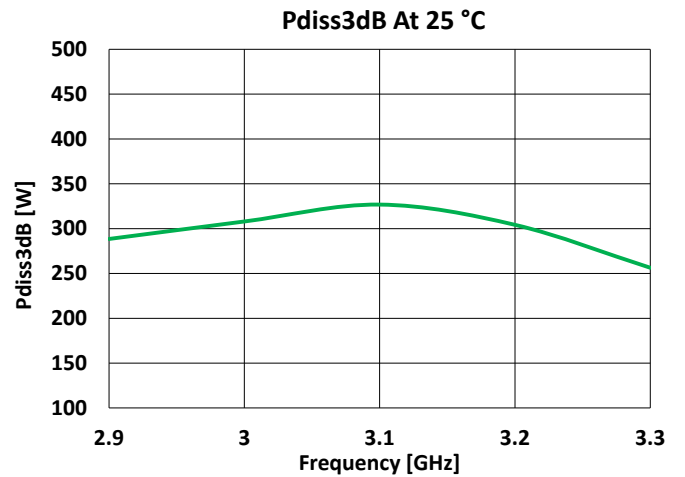
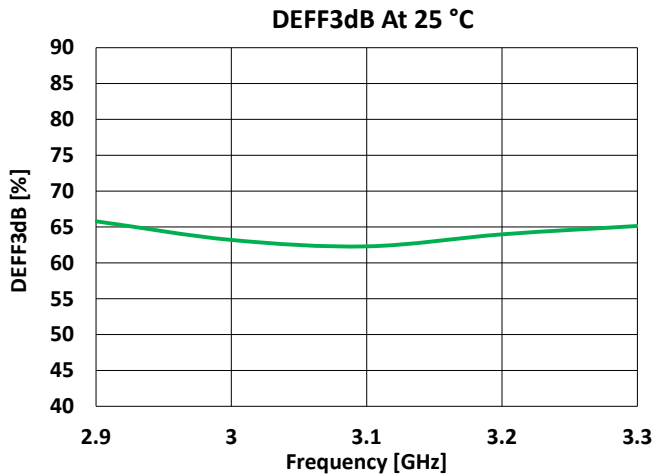
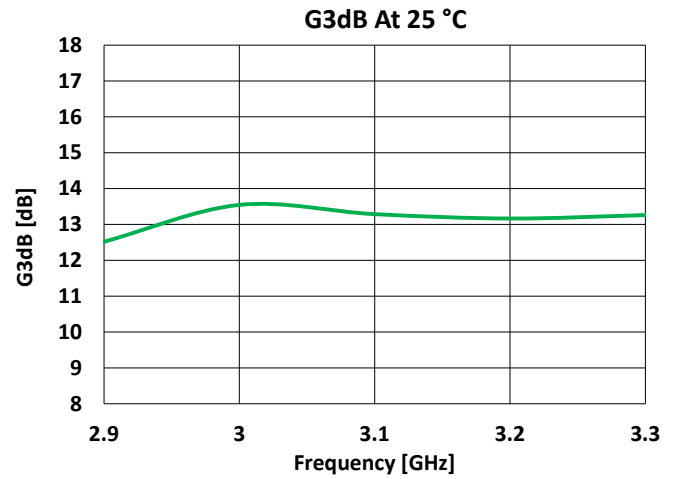
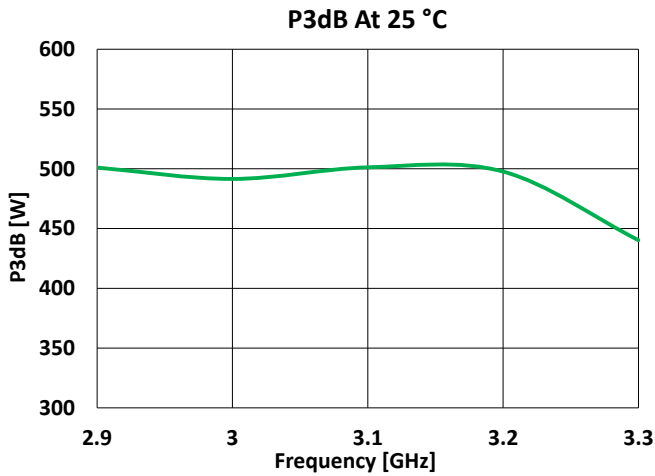

S-Parameters At -40°C Of 2.9 – 3.3 GHz EVB^{1,2}

Notes:

1. $V_D = 50\text{ V}$, $I_{DQ} = 750\text{ mA}$, 100 uS PW , $10\% \text{ DC}$, $T_A = -40^\circ\text{C}$.
2. Performance shown is at EVB connectors reference plane.

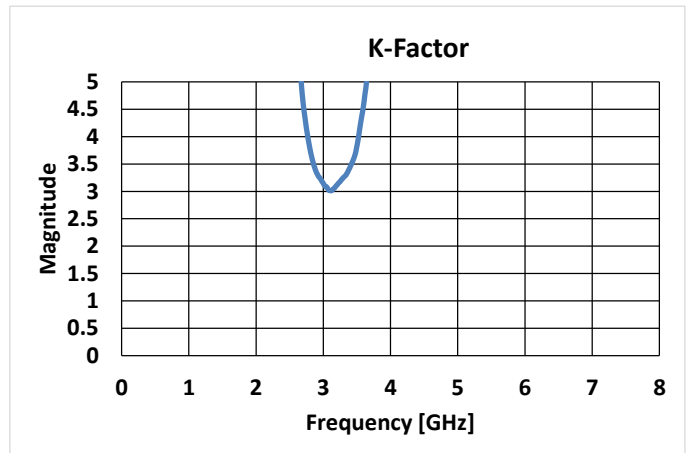
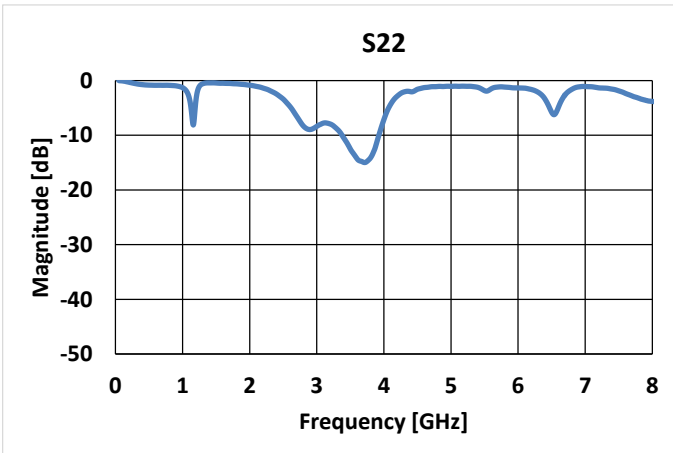
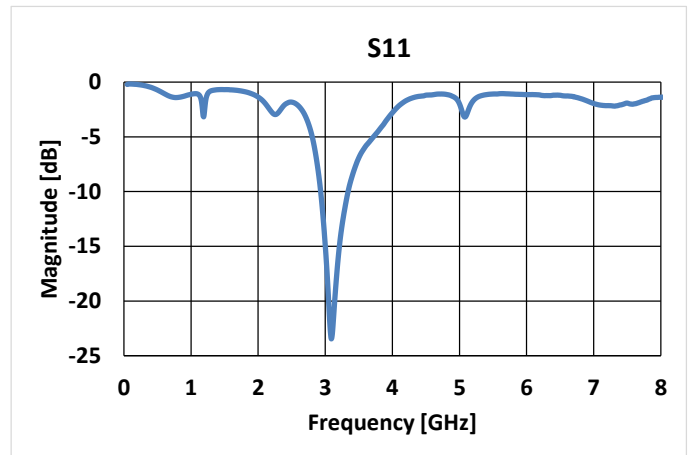
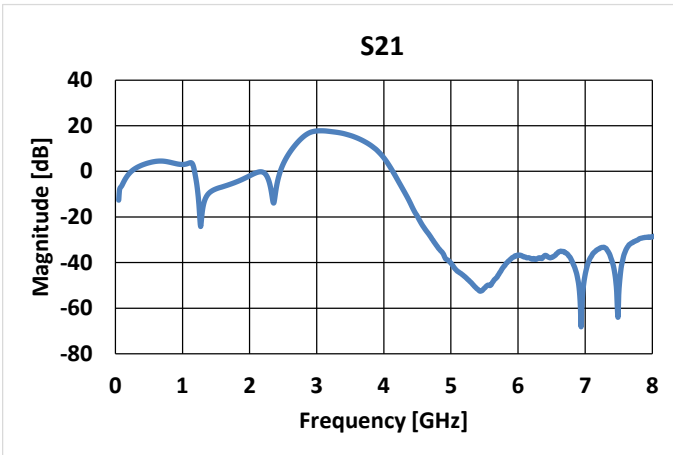

Pin Configuration and Description ¹

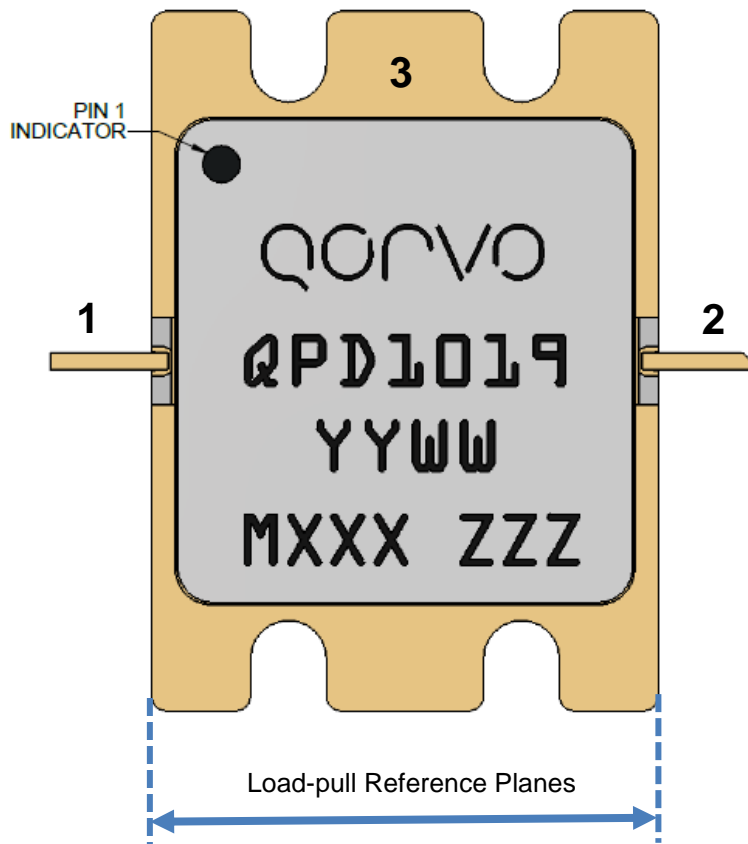

¹ The QPD1019 will be marked with the “QPD1019” designator and a lot code marked below the part designator. The “YY” is the last two digits of the calendar year and “WW” is the sequential week number of assembly lot start. “MXXX” is the batch ID. “ZZZ” is unique for all parts within one assembly lot.

Pin Description

Pin	Symbol	Description
1	V_G / RF IN	Gate voltage / RF Input
2	V_D / RF OUT	Drain voltage / RF Output
3	GND	Package base / Ground

Package Marking and Dimensions 1, 2, 3, 4

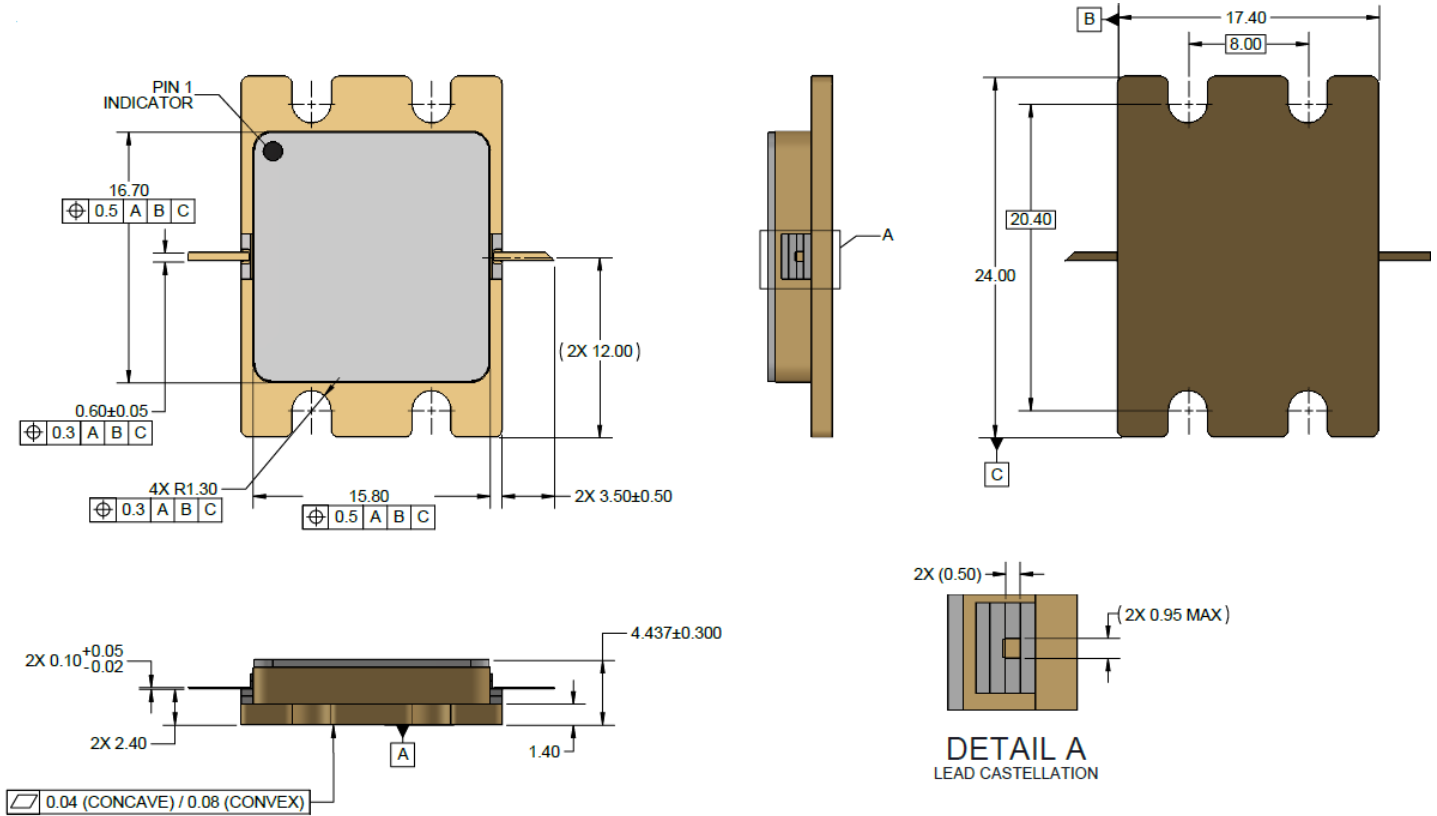

Notes:

1. All dimensions are in mm. Unless otherwise noted, the tolerance is ± 0.15 mm.
2. Package is an all metal design with ceramic lid and feedthru's.
3. Package is NiAu plated.
4. Package is epoxy sealed.

Schematic – 2.9 – 3.3 GHz EVB

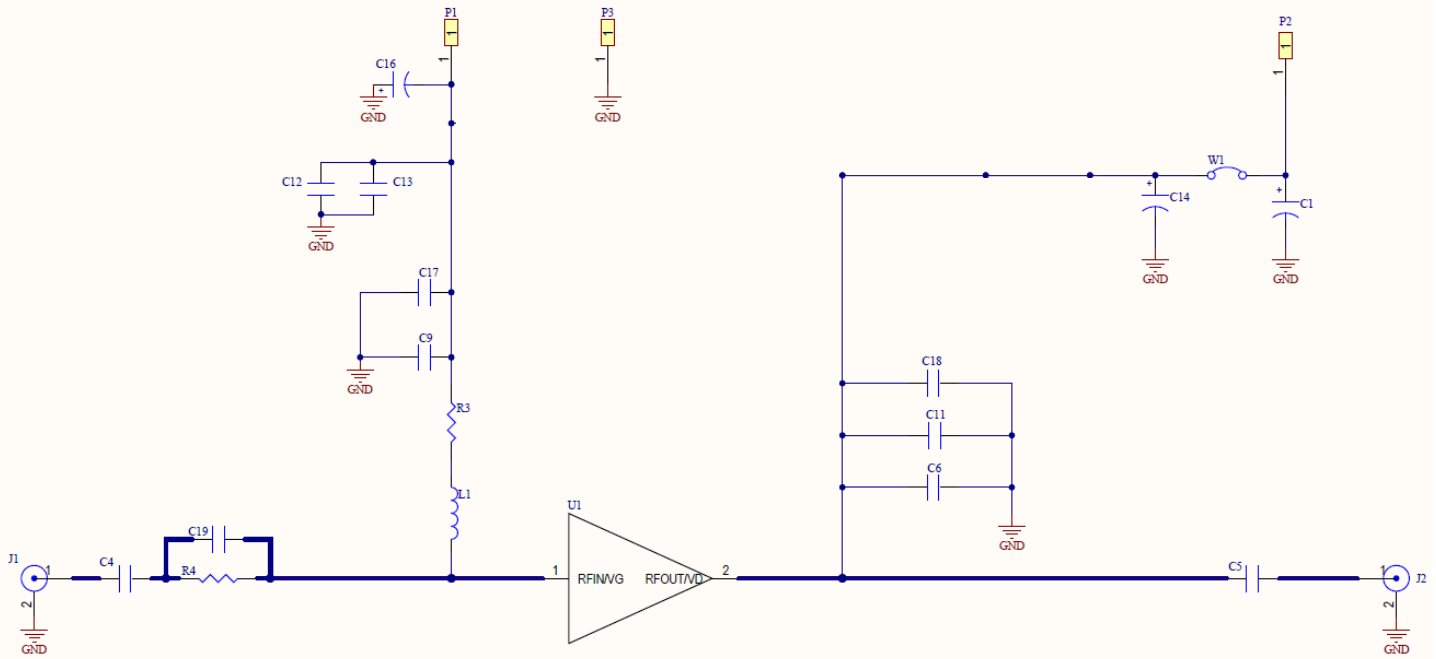

Bias-up Procedure

1. Set V_G to -6 V.
2. Set I_D current limit to 1000 mA.
3. Apply 50 V V_D .
4. Slowly adjust V_G until I_D is set to 750 mA.
5. Set I_D current limit to 2 A
6. Apply RF.

Bias-down Procedure

1. Turn off RF signal.
2. Turn off V_D
3. Wait 2 seconds to allow drain capacitor to discharge
4. Turn off V_G

PCB Assembly – 2.9 – 3.3 GHz EVB

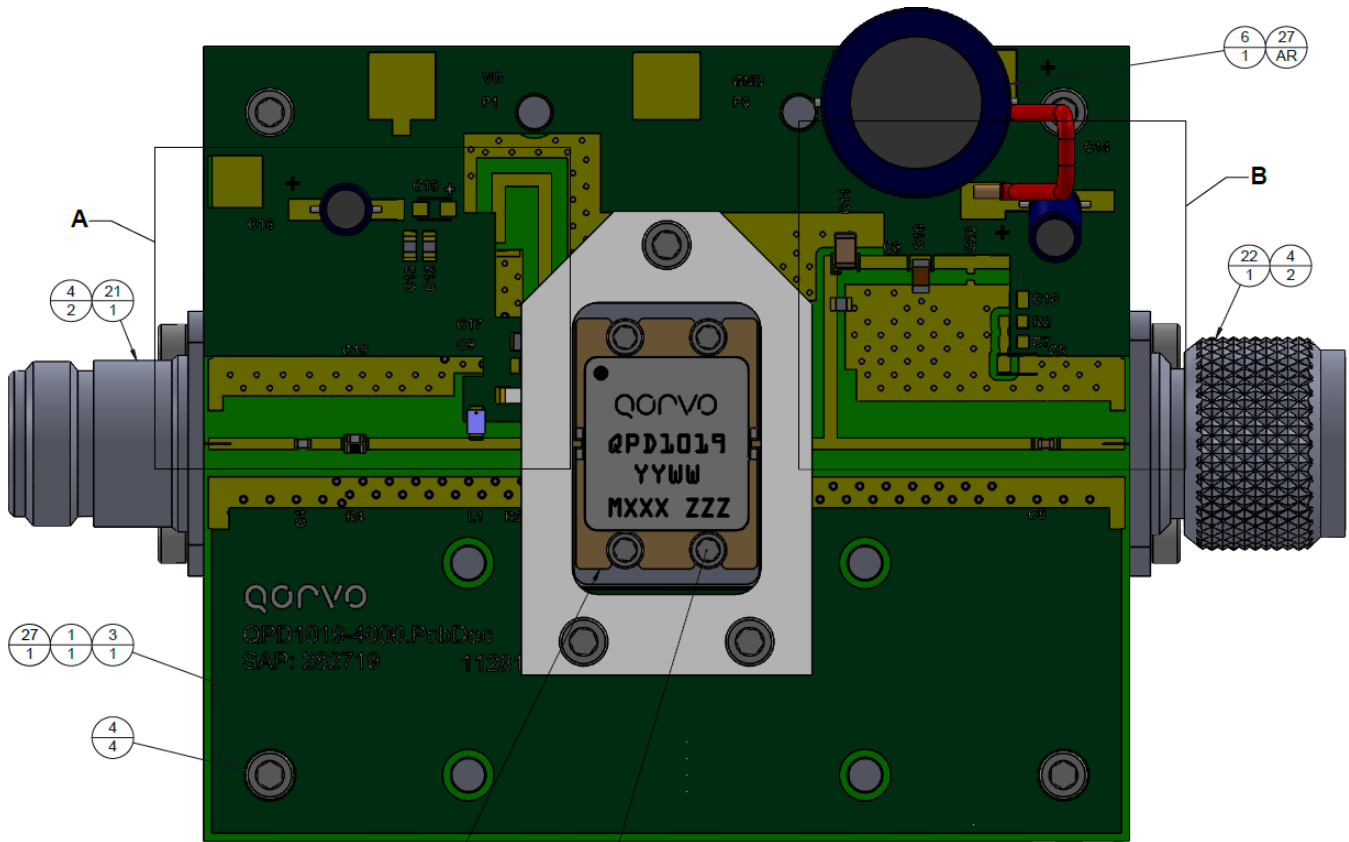

Notes:

1. PCB Material: RO4350B, 20 mil thickness, 1 oz copper cladding

Bill Of material – 2.9 – 3.3 GHz EVB

Ref Des	Value	Qty	Manufacturer	Part Number
C1	680 uF	1	Panasonic	EEU-FC2A681
C4, C19	10 pF	2	ATC	ATC600S100JW250XT
C5	15 pF	1	ATC	ATC600S150FT250XT
C6, C9	10 pF	2	ATC	ATC600F100BT250XT
C12	10000 pF	1	Panasonic	ECJ-2VB2A103K
C11	0.1 uF	1	Murata	GRM32NR72A104KA01L
C13	0.1 uF	1	Panasonic	ECJ-2YB1H104K
C14, C16	10 uF	2	Panasonic	ECA-2AM100
C17, C18	10000 pF	2	Samsung	CL31B103KGFNNE
R3	10 Ohm	1	Panasonic	ERJ-8GEYJ100V
R4	1 kOhm	1	Vishay	CRCW06031K00FKTA
L1	22 nH	1	Coilcraft	0805HT-22NTJLB

Recommended Solder Temperature Profile

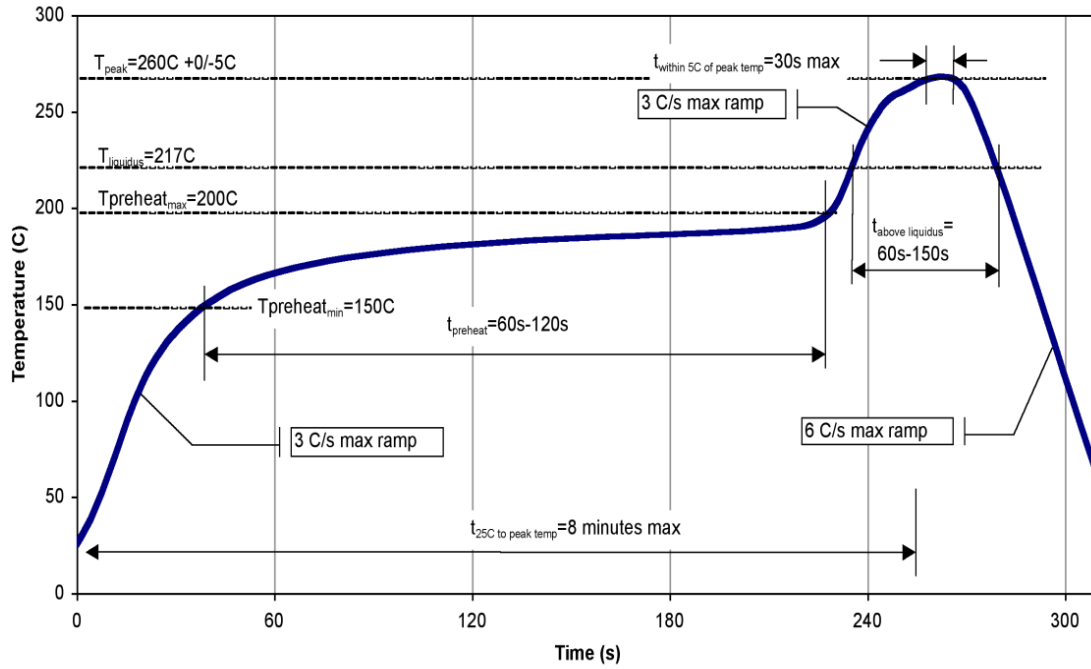

Handling Precautions

Parameter	Rating	Standard
ESD – Human Body Model (HBM)	Class 1C, 1800 V	ESDA / JEDEC JS-001-2012
ESD – Charged Device Model (CDM)	Class C3, 1000 V	JEDEC JESD22-C101F
MSL – Moisture Sensitivity Level	MSL3	IPC/JEDEC J-STD-020



Caution!
ESD-Sensitive Device

Solderability

Compatible with both lead-free (260°C max. reflow temp.) and tin/lead (245°C max. reflow temp.) soldering processes. Solder profiles available upon request.

Contact plating: Ni/Au. Minimum Au thickness is 1.0 µm.

RoHS Compliance

This part is compliant with 2011/65/EU RoHS directive (Restrictions on the Use of Certain Hazardous Substances in Electrical and Electronic Equipment) as amended by Directive 2015/863/EU.

This product also has the following attributes:

- Halogen Free (Chlorine, Bromine)
- Antimony Free
- TBBP-A (C₁₅H₁₂Br₄O₂) Free
- PFOS Free
- SVHC Free
- Product uses RoHS Exemptions 7c-I and 7c-II to meet RoHS Compliance requirements.

Contact Information

For the latest specifications, additional product information, worldwide sales and distribution locations, and information about Qorvo:

Web: www.qorvo.com
Email: info-sales@qorvo.com

Tel: +1.844.890.8163

For technical questions and application information: **Email:** info-products@qorvo.com

Important Notice

The information contained herein is believed to be reliable; however, Qorvo makes no warranties regarding the information contained herein and assumes no responsibility or liability whatsoever for the use of the information contained herein. All information contained herein is subject to change without notice. Customers should obtain and verify the latest relevant information before placing orders for Qorvo products. The information contained herein or any use of such information does not grant, explicitly or implicitly, to any party any patent rights, licenses, or any other intellectual property rights, whether with regard to such information itself or anything described by such information. **THIS INFORMATION DOES NOT CONSTITUTE A WARRANTY WITH RESPECT TO THE PRODUCTS DESCRIBED HEREIN, AND QORVO HEREBY DISCLAIMS ANY AND ALL WARRANTIES WITH RESPECT TO SUCH PRODUCTS WHETHER EXPRESS OR IMPLIED BY LAW, COURSE OF DEALING, COURSE OF PERFORMANCE, USAGE OF TRADE OR OTHERWISE, INCLUDING THE IMPLIED WARRANTIES OF MERCHANTABILITY AND FITNESS FOR A PARTICULAR PURPOSE.**

Without limiting the generality of the foregoing, Qorvo products are not warranted or authorized for use as critical components in medical, life-saving, or life-sustaining applications, or other applications where a failure would reasonably be expected to cause severe personal injury or death.

Copyright 2016 © Qorvo, Inc. | Qorvo is a registered trademark of Qorvo, Inc.

Компания «Life Electronics» занимается поставками электронных компонентов импортного и отечественного производства от производителей и со складов крупных дистрибьюторов Европы, Америки и Азии.

С конца 2013 года компания активно расширяет линейку поставок компонентов по направлению коаксиальный кабель, кварцевые генераторы и конденсаторы (керамические, пленочные, электролитические), за счёт заключения дистрибьюторских договоров

Мы предлагаем:

- Конкуренспособные цены и скидки постоянным клиентам.
- Специальные условия для постоянных клиентов.
- Подбор аналогов.
- Поставку компонентов в любых объемах, удовлетворяющих вашим потребностям.
- Приемлемые сроки поставки, возможна ускоренная поставка.
- Доставку товара в любую точку России и стран СНГ.
- Комплексную поставку.
- Работу по проектам и поставку образцов.
- Формирование склада под заказчика.
- Сертификаты соответствия на поставляемую продукцию (по желанию клиента).
- Тестирование поставляемой продукции.
- Поставку компонентов, требующих военную и космическую приемку.
- Входной контроль качества.
- Наличие сертификата ISO.

В составе нашей компании организован Конструкторский отдел, призванный помогать разработчикам, и инженерам.

Конструкторский отдел помогает осуществить:

- Регистрацию проекта у производителя компонентов.
- Техническую поддержку проекта.
- Защиту от снятия компонента с производства.
- Оценку стоимости проекта по компонентам.
- Изготовление тестовой платы монтаж и пусконаладочные работы.



Тел: +7 (812) 336 43 04 (многоканальный)

Email: org@lifeelectronics.ru