



RF Power LDMOS Transistor

N-Channel Enhancement-Mode Lateral MOSFET

This 87 W asymmetrical Doherty RF power LDMOS transistor is designed for cellular base station applications requiring very wide instantaneous bandwidth capability covering the frequency range of 2110 to 2200 MHz.

2100 MHz

- Typical Doherty Single-Carrier W-CDMA Characterization Performance:
 $V_{DD} = 30$ Vdc, $I_{DQA} = 600$ mA, $V_{GSB} = 0.5$ Vdc, $P_{out} = 87$ W Avg., Input Signal PAR = 9.9 dB @ 0.01% Probability on CCDF.

Frequency	G_{ps} (dB)	η_D (%)	Output PAR (dB)	ACPR (dBc)
2110 MHz	15.1	48.5	8.1	-30.2
2155 MHz	15.7	48.9	7.9	-30.2
2200 MHz	15.3	47.2	7.8	-33.7

Features

- Advanced high performance in-package Doherty
- Designed for wide instantaneous bandwidth applications
- Greater negative gate-source voltage range for improved Class C operation
- Able to withstand extremely high output VSWR and broadband operating conditions
- Designed for digital predistortion error correction systems

A3T21H450W23SR6

**2110–2200 MHz, 87 W AVG., 30 V
 AIRFAST RF POWER LDMOS
 TRANSISTOR**



ACP-1230S-4L2S

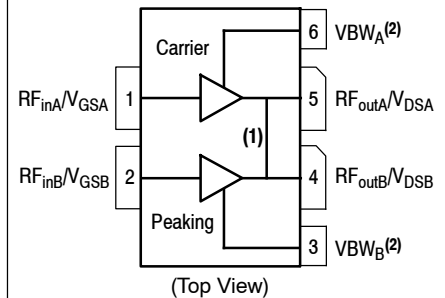

Figure 1. Pin Connections

- Pin connections 4 and 5 are DC coupled and RF independent.
- Device cannot operate with V_{DD} current supplied through pin 3 and pin 6.

Table 1. Maximum Ratings

Rating	Symbol	Value	Unit
Drain-Source Voltage	V_{DSS}	-0.5, +65	Vdc
Gate-Source Voltage	V_{GS}	-6.0, +10	Vdc
Operating Voltage	V_{DD}	32, +0	Vdc
Storage Temperature Range	T_{stg}	-65 to +150	°C
Case Operating Temperature Range	T_C	-40 to +150	°C
Operating Junction Temperature Range (1,2)	T_J	-40 to +225	°C

Table 2. Thermal Characteristics

Characteristic	Symbol	Value (2,3)	Unit
Thermal Resistance, Junction to Case Case Temperature 78°C, 87 W Avg., W-CDMA, 30 Vdc, $I_{DQA} = 600$ mA, $V_{GSB} = 0.5$ Vdc, 2155 MHz	$R_{\theta JC}$	0.16	°C/W

Table 3. ESD Protection Characteristics

Test Methodology	Class
Human Body Model (per JESD22-A114)	2
Charge Device Model (per JESD22-C101)	C3

Table 4. Electrical Characteristics ($T_A = 25^\circ\text{C}$ unless otherwise noted)

Characteristic	Symbol	Min	Typ	Max	Unit
----------------	--------	-----	-----	-----	------

Off Characteristics (4)

Zero Gate Voltage Drain Leakage Current ($V_{DS} = 65$ Vdc, $V_{GS} = 0$ Vdc)	I_{DSS}	—	—	10	μAdc
Zero Gate Voltage Drain Leakage Current ($V_{DS} = 32$ Vdc, $V_{GS} = 0$ Vdc)	I_{DSS}	—	—	5	μAdc
Gate-Source Leakage Current ($V_{GS} = 5$ Vdc, $V_{DS} = 0$ Vdc)	I_{GSS}	—	—	1	μAdc

On Characteristics - Side A, Carrier

Gate Threshold Voltage ($V_{DS} = 10$ Vdc, $I_D = 180$ μAdc)	$V_{GS(th)}$	1.4	1.8	2.3	Vdc
Gate Quiescent Voltage ($V_{DD} = 30$ Vdc, $I_D = 600$ mAdc, Measured in Functional Test)	$V_{GSA(Q)}$	2.2	2.6	3.0	Vdc
Drain-Source On-Voltage ($V_{GS} = 10$ Vdc, $I_D = 1.8$ Adc)	$V_{DS(on)}$	0.0	0.15	0.3	Vdc

On Characteristics - Side B, Peaking

Gate Threshold Voltage ($V_{DS} = 10$ Vdc, $I_D = 360$ μAdc)	$V_{GS(th)}$	0.8	1.2	1.6	Vdc
Drain-Source On-Voltage ($V_{GS} = 10$ Vdc, $I_D = 3.6$ Adc)	$V_{DS(on)}$	0.0	0.15	0.3	Vdc

1. Continuous use at maximum temperature will affect MTTF.
2. MTTF calculator available at <http://www.nxp.com/RF/calculators>.
3. Refer to AN1955, *Thermal Measurement Methodology of RF Power Amplifiers*. Go to <http://www.nxp.com/RF> and search for AN1955.
4. Side A and Side B are tied together for these measurements.

(continued)

Table 4. Electrical Characteristics ($T_A = 25^\circ\text{C}$ unless otherwise noted) (continued)

Characteristic	Symbol	Min	Typ	Max	Unit
Functional Tests ^(1,2,3) (In NXP Doherty Production Test Fixture, 50 ohm system) $V_{DD} = 30\text{ Vdc}$, $I_{DQA} = 600\text{ mA}$, $V_{GSB} = 0.5\text{ Vdc}$, $P_{out} = 87\text{ W Avg.}$, $f = 2200\text{ MHz}$, Single-Carrier W-CDMA, IQ Magnitude Clipping, Input Signal PAR = 9.9 dB @ 0.01% Probability on CCDF. ACPR measured in 3.84 MHz Channel Bandwidth @ $\pm 5\text{ MHz}$ Offset.					
Power Gain	G_{ps}	14.2	15.4	16.2	dB
Drain Efficiency	η_D	44.0	47.0	—	%
P_{out} @ 3 dB Compression Point, CW	P3dB	55.0	55.9	—	dBm
Adjacent Channel Power Ratio	ACPR	—	-35.2	-30.9	dBc

Load Mismatch ⁽³⁾ (In NXP Doherty Production Test Fixture, 50 ohm system) $I_{DQA} = 600\text{ mA}$, $V_{GSB} = 0.5\text{ Vdc}$, $f = 2155\text{ MHz}$, 12 μsec (on), 10% Duty Cycle

VSWR 10:1 at 32 Vdc, 400 W Pulsed CW Output Power (3 dB Input Overdrive from 251 W Pulsed CW Rated Power)	No Device Degradation
---	-----------------------

Typical Performance ⁽³⁾ (In NXP Doherty Characterization Test Fixture, 50 ohm system) $V_{DD} = 30\text{ Vdc}$, $I_{DQA} = 600\text{ mA}$, $V_{GSB} = 0.5\text{ Vdc}$, 2110–2200 MHz Bandwidth

P_{out} @ 3 dB Compression Point ⁽⁴⁾	P3dB	—	501	—	W
AM/PM (Maximum value measured at the P3dB compression point across the 2110–2200 MHz bandwidth)	Φ	—	-19	—	$^\circ$
VBW Resonance Point (IMD Third Order Intermodulation Inflection Point)	VBW_{res}	—	180	—	MHz
Gain Flatness in 90 MHz Bandwidth @ $P_{out} = 87\text{ W Avg.}$	G_F	—	0.7	—	dB
Gain Variation over Temperature (-30°C to +85°C)	ΔG	—	0.007	—	dB/°C
Output Power Variation over Temperature (-30°C to +85°C)	ΔP_{1dB}	—	0.007	—	dB/°C

Table 5. Ordering Information

Device	Tape and Reel Information	Package
A3T21H450W23SR6	R6 Suffix = 150 Units, 56 mm Tape Width, 13-inch Reel	ACP-1230S-4L2S

- V_{DDA} and V_{DDB} must be tied together and powered by a single DC power supply.
- Part internally matched both on input and output.
- Measurements made with device in an asymmetrical Doherty configuration.
- P3dB = $P_{avg} + 7.0\text{ dB}$ where P_{avg} is the average output power measured using an unclipped W-CDMA single-carrier input signal where output PAR is compressed to 7.0 dB @ 0.01% probability on CCDF.

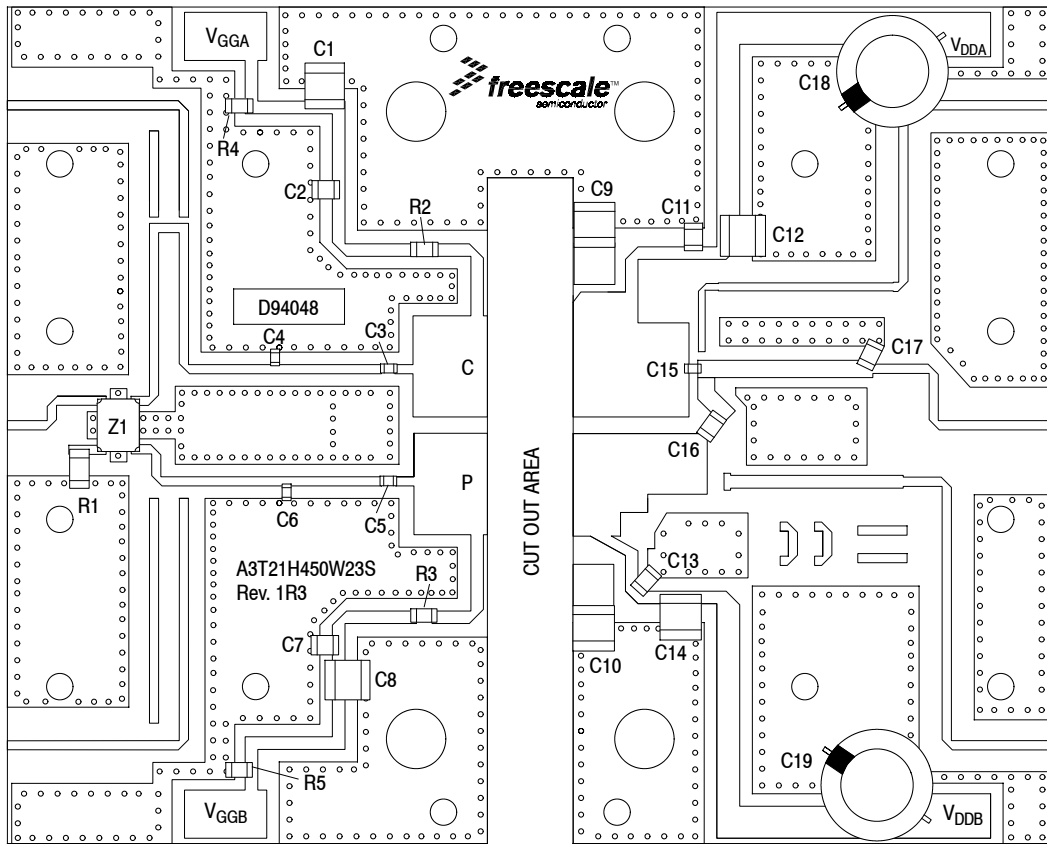

Note: V_{DDA} and V_{ddb} must be tied together and powered by a single DC power supply.

Figure 2. A3T21H450W23SR6 Characterization Test Circuit Component Layout

Table 6. A3T21H450W23SR6 Characterization Test Circuit Component Designations and Values

Part	Description	Part Number	Manufacturer
C1, C8, C9, C10, C12, C14	10 μ F Chip Capacitor	C5750X7S2A106M230KB	TDK
C2, C7, C11, C13	9.1 pF Chip Capacitor	ATC100B9R1CT500XT	ATC
C3, C5	9.1 pF Chip Capacitor	ATC600F9R1BT250XT	ATC
C4	1 pF Chip Capacitor	ATC100B1R0CT500XT	ATC
C6	0.4 pF Chip Capacitor	ATC100B0R4CT500XT	ATC
C15	5.1 pF Chip Capacitor	ATC600F5R1BT250XT	ATC
C16	15 pF Chip Capacitor	ATC100B150JT500XT	ATC
C17	0.2 pF Chip Capacitor	ATC100B0R2BT500XT	ATC
C18, C19	470 μ F, 63 V Electrolytic Capacitor	MCGPR63V477M13X26-RH	Multicomp
R1	50 Ω , 10 W Chip Resistor	C10A50Z4	Anaren
R2, R3	3.9 Ω , 1/4 W Chip Resistor	CRCW12063R90FKEA	Vishay
R4, R5	1.8 k Ω , 1/4 W Chip Resistor	CRCW12061K80FKEA	Vishay
Z1	2000–2300 MHz Band, 90°, 5 dB Directional Coupler	X3C21P1-05S	Anaren
PCB	Rogers RO4350B, 0.020", $\epsilon_r = 3.66$	D94048	MTL

TYPICAL CHARACTERISTICS — 2110–2200 MHz

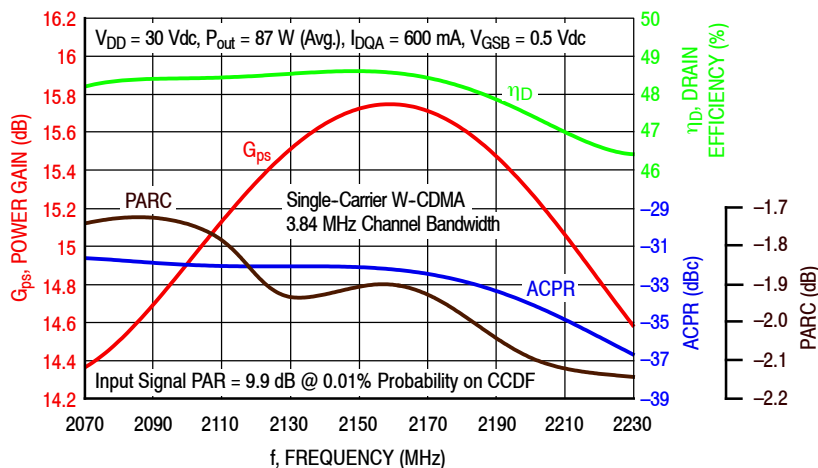

Figure 3. Single-Carrier Output Peak-to-Average Ratio Compression (PARC) Broadband Performance @ $P_{out} = 87$ Watts Avg.

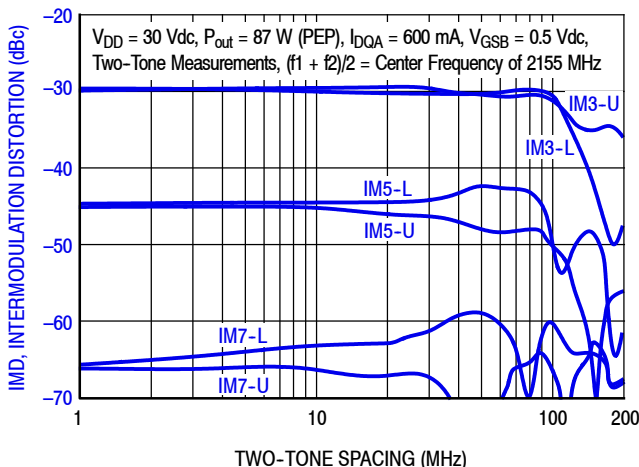

Figure 4. Intermodulation Distortion Products versus Two-Tone Spacing

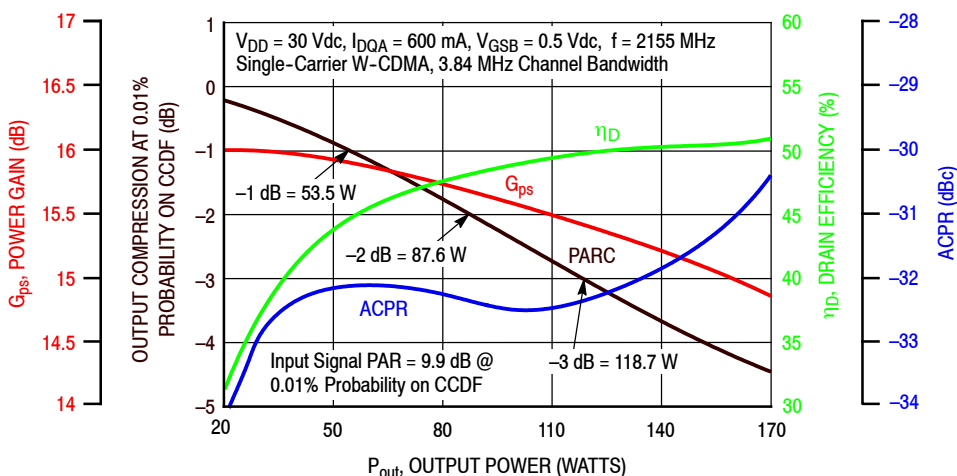

Figure 5. Output Peak-to-Average Ratio Compression (PARC) versus Output Power

TYPICAL CHARACTERISTICS — 2110–2200 MHz

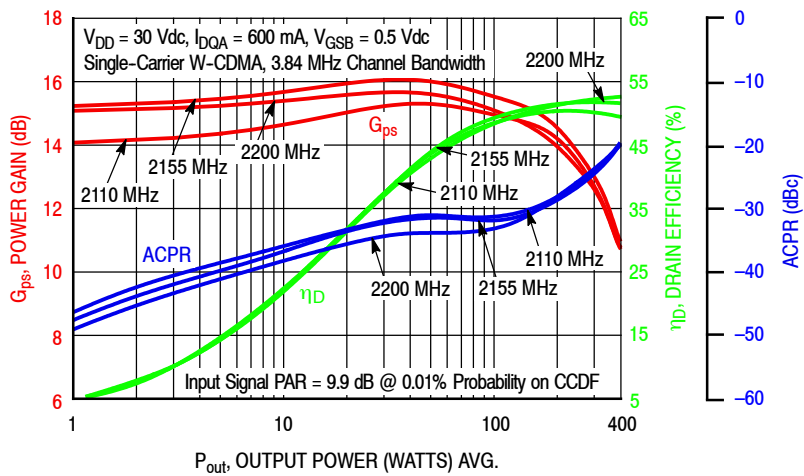

Figure 6. Single-Carrier W-CDMA Power Gain, Drain Efficiency and ACPR versus Output Power

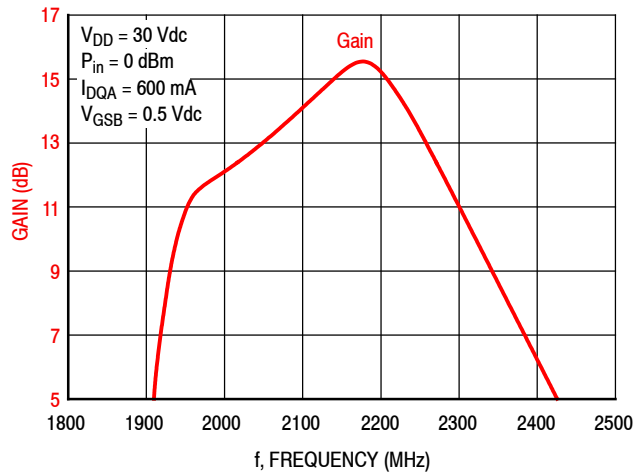

Figure 7. Broadband Frequency Response

Table 7. Carrier Side Load Pull Performance — Maximum Power TuningV_{DD} = 30 Vdc, I_{DQA} = 804 mA, Pulsed CW, 10 μsec(on), 10% Duty Cycle

f (MHz)	Z _{source} (Ω)	Z _{in} (Ω)	Max Output Power					
			P1dB					
			Z _{load} ⁽¹⁾ (Ω)	Gain (dB)	(dBm)	(W)	η _D (%)	AM/PM (°)
2110	2.26 – j6.69	2.28 + j6.33	1.26 – j4.31	18.2	53.5	224	58.7	–14
2140	2.79 – j7.42	2.93 + j7.10	1.32 – j4.37	18.3	53.4	218	58.1	–15
2170	4.03 – j8.18	3.88 + j7.96	1.29 – j4.36	18.3	53.3	216	57.9	–14
2200	5.37 – j9.47	5.43 + j8.78	1.32 – j4.37	18.3	53.3	213	56.4	–15

f (MHz)	Z _{source} (Ω)	Z _{in} (Ω)	Max Output Power					
			P3dB					
			Z _{load} ⁽²⁾ (Ω)	Gain (dB)	(dBm)	(W)	η _D (%)	AM/PM (°)
2110	2.26 – j6.69	2.20 + j6.63	1.24 – j4.55	15.9	54.2	263	59.3	–19
2140	2.79 – j7.42	2.87 + j7.50	1.30 – j4.58	16.1	54.1	257	59.0	–19
2170	4.03 – j8.18	3.90 + j8.49	1.31 – j4.57	16.1	54.1	256	58.7	–18
2200	5.37 – j9.47	5.62 + j9.53	1.31 – j4.54	16.0	54.0	253	57.6	–19

(1) Load impedance for optimum P1dB power.

(2) Load impedance for optimum P3dB power.

Z_{source} = Measured impedance presented to the input of the device at the package reference plane.Z_{in} = Impedance as measured from gate contact to ground.Z_{load} = Measured impedance presented to the output of the device at the package reference plane.**Table 8. Carrier Side Load Pull Performance — Maximum Efficiency Tuning**V_{DD} = 30 Vdc, I_{DQA} = 804 mA, Pulsed CW, 10 μsec(on), 10% Duty Cycle

f (MHz)	Z _{source} (Ω)	Z _{in} (Ω)	Max Drain Efficiency					
			P1dB					
			Z _{load} ⁽¹⁾ (Ω)	Gain (dB)	(dBm)	(W)	η _D (%)	AM/PM (°)
2110	2.26 – j6.69	2.33 + j6.54	2.68 – j3.37	20.7	51.7	148	69.2	–20
2140	2.79 – j7.42	3.03 + j7.31	2.73 – j3.29	20.9	51.4	138	67.3	–20
2170	4.03 – j8.18	3.98 + j8.13	2.24 – j3.62	20.3	52.1	163	67.2	–18
2200	5.37 – j9.47	5.53 + j9.11	2.19 – j3.17	20.7	51.6	144	65.5	–19

f (MHz)	Z _{source} (Ω)	Z _{in} (Ω)	Max Drain Efficiency					
			P3dB					
			Z _{load} ⁽²⁾ (Ω)	Gain (dB)	(dBm)	(W)	η _D (%)	AM/PM (°)
2110	2.26 – j6.69	2.25 + j6.72	2.63 – j3.88	18.3	52.7	187	68.7	–24
2140	2.79 – j7.42	3.04 + j7.57	2.84 – j3.95	18.3	52.5	177	66.4	–22
2170	4.03 – j8.18	4.05 + j8.54	2.49 – j4.00	18.1	52.9	193	66.8	–21
2200	5.37 – j9.47	5.86 + j9.55	2.54 – j3.69	18.3	52.6	184	66.3	–23

(1) Load impedance for optimum P1dB efficiency.

(2) Load impedance for optimum P3dB efficiency.

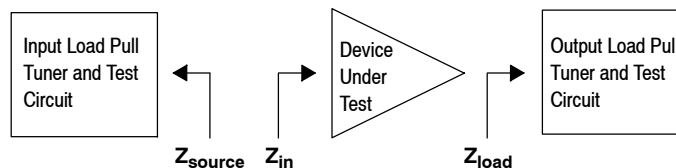
Z_{source} = Measured impedance presented to the input of the device at the package reference plane.Z_{in} = Impedance as measured from gate contact to ground.Z_{load} = Measured impedance presented to the output of the device at the package reference plane.

A3T21H450W23SR6

Table 9. Peaking Side Load Pull Performance — Maximum Power Tuning

$V_{DD} = 30$ Vdc, $V_{GSB} = 1.8$ Vdc, Pulsed CW, 10 μ sec(on), 10% Duty Cycle

f (MHz)	Z_{source} (Ω)	Z_{in} (Ω)	Max Output Power					
			P1dB					
			$Z_{load}^{(1)}$ (Ω)	Gain (dB)	(dBm)	(W)	η_D (%)	AM/PM ($^\circ$)
2110	2.11 – j7.12	1.48 + j6.12	3.76 – j4.75	17.7	56.1	405	54.5	–15
2140	2.61 – j7.79	1.78 + j6.77	4.05 – j4.63	18.1	56.0	399	54.4	–15
2170	3.53 – j8.88	2.25 + j7.54	4.56 – j4.43	18.2	56.0	395	54.3	–16
2200	4.62 – j10.2	2.97 + j8.37	4.94 – j4.19	18.3	55.9	388	53.6	–17

f (MHz)	Z_{source} (Ω)	Z_{in} (Ω)	Max Output Power					
			P3dB					
			$Z_{load}^{(2)}$ (Ω)	Gain (dB)	(dBm)	(W)	η_D (%)	AM/PM ($^\circ$)
2110	2.11 – j7.12	1.48 + j6.40	4.35 – j5.05	15.6	56.6	460	54.9	–20
2140	2.61 – j7.79	1.82 + j7.12	4.95 – j4.79	16.0	56.6	453	54.5	–21
2170	3.53 – j8.88	2.35 + j7.96	5.17 – j4.46	16.1	56.5	449	54.6	–22
2200	4.62 – j10.2	3.21 + j8.90	5.69 – j4.11	16.1	56.4	440	53.7	–23

(1) Load impedance for optimum P1dB power.

(2) Load impedance for optimum P3dB power.

Z_{source} = Measured impedance presented to the input of the device at the package reference plane.

Z_{in} = Impedance as measured from gate contact to ground.

Z_{load} = Measured impedance presented to the output of the device at the package reference plane.

Table 10. Peaking Side Load Pull Performance — Maximum Efficiency Tuning

$V_{DD} = 30$ Vdc, $V_{GSB} = 1.8$ Vdc, Pulsed CW, 10 μ sec(on), 10% Duty Cycle

f (MHz)	Z_{source} (Ω)	Z_{in} (Ω)	Max Drain Efficiency					
			P1dB					
			$Z_{load}^{(1)}$ (Ω)	Gain (dB)	(dBm)	(W)	η_D (%)	AM/PM ($^\circ$)
2110	2.11 – j7.12	1.30 + j6.07	3.28 – j2.25	19.4	55.1	323	61.4	–21
2140	2.61 – j7.79	1.55 + j6.69	2.94 – j2.24	19.8	54.9	312	61.8	–23
2170	3.53 – j8.88	1.92 + j7.43	2.66 – j1.97	20.1	54.6	288	62.3	–25
2200	4.62 – j10.2	2.55 + j8.26	2.72 – j2.01	20.1	54.6	291	61.8	–26

f (MHz)	Z_{source} (Ω)	Z_{in} (Ω)	Max Drain Efficiency					
			P3dB					
			$Z_{load}^{(2)}$ (Ω)	Gain (dB)	(dBm)	(W)	η_D (%)	AM/PM ($^\circ$)
2110	2.11 – j7.12	1.33 + j6.35	3.83 – j2.30	17.3	55.8	377	59.4	–27
2140	2.61 – j7.79	1.64 + j7.05	3.63 – j2.16	17.7	55.7	372	59.7	–28
2170	3.53 – j8.88	2.09 + j7.87	3.22 – j1.97	17.9	55.5	353	59.9	–30
2200	4.62 – j10.2	2.85 + j8.81	3.24 – j1.95	17.9	55.5	352	59.7	–31

(1) Load impedance for optimum P1dB efficiency.

(2) Load impedance for optimum P3dB efficiency.

Z_{source} = Measured impedance presented to the input of the device at the package reference plane.

Z_{in} = Impedance as measured from gate contact to ground.

Z_{load} = Measured impedance presented to the output of the device at the package reference plane.

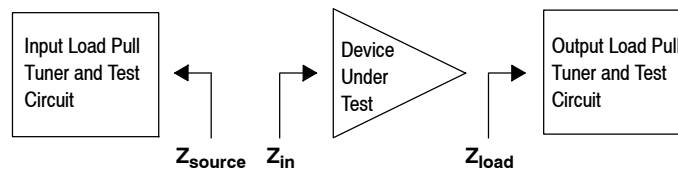

A3T21H450W23SR6

P1dB – TYPICAL CARRIER SIDE LOAD PULL CONTOURS — 2140 MHz

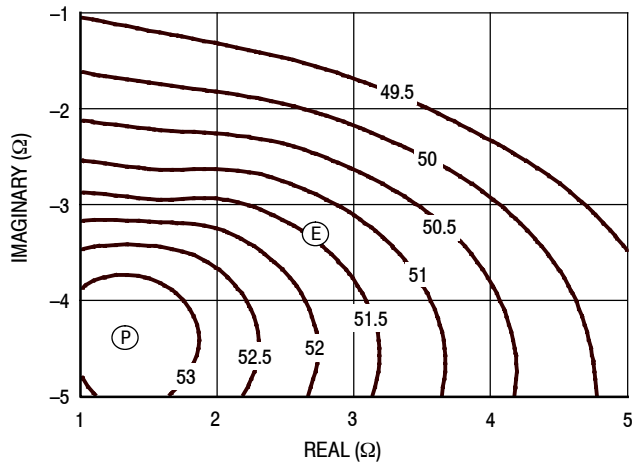

Figure 8. P1dB Load Pull Output Power Contours (dBm)

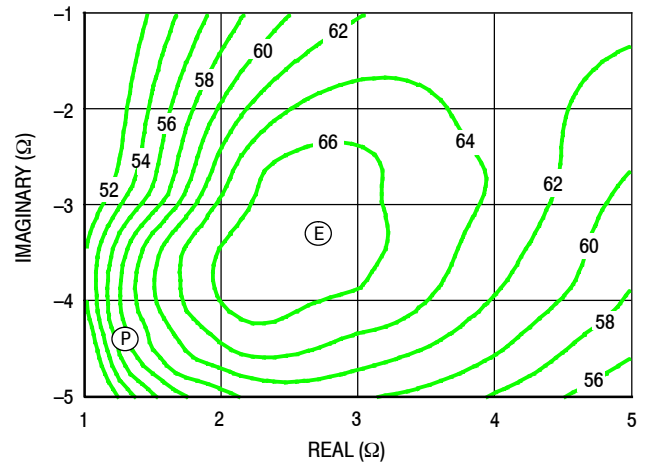

Figure 9. P1dB Load Pull Efficiency Contours (%)

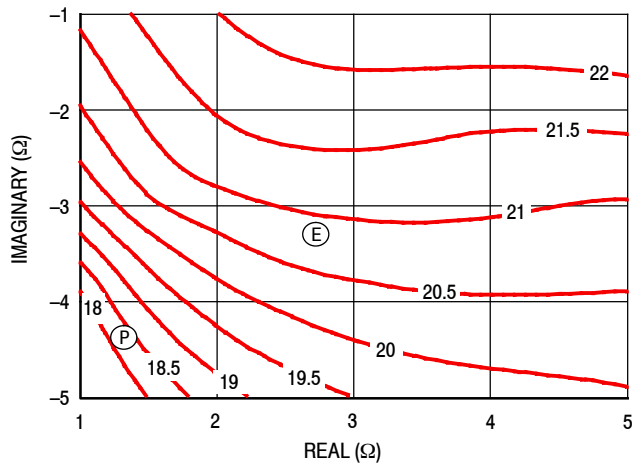

Figure 10. P1dB Load Pull Gain Contours (dB)

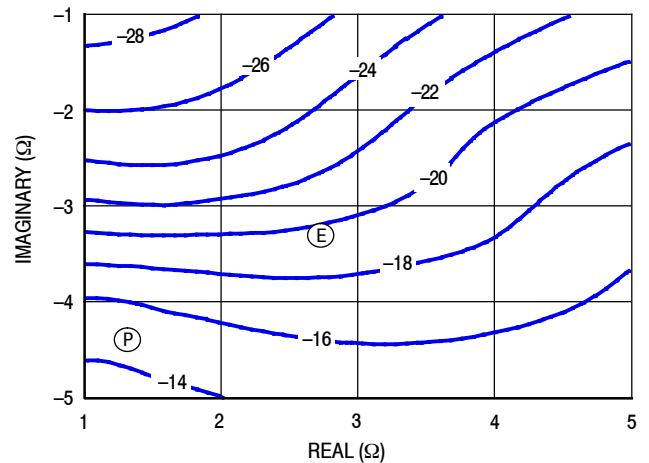

Figure 11. P1dB Load Pull AM/PM Contours (°)

NOTE: (P) = Maximum Output Power
(E) = Maximum Drain Efficiency

- Gain
- Drain Efficiency
- Linearity
- Output Power

P3dB – TYPICAL CARRIER SIDE LOAD PULL CONTOURS — 2140 MHz

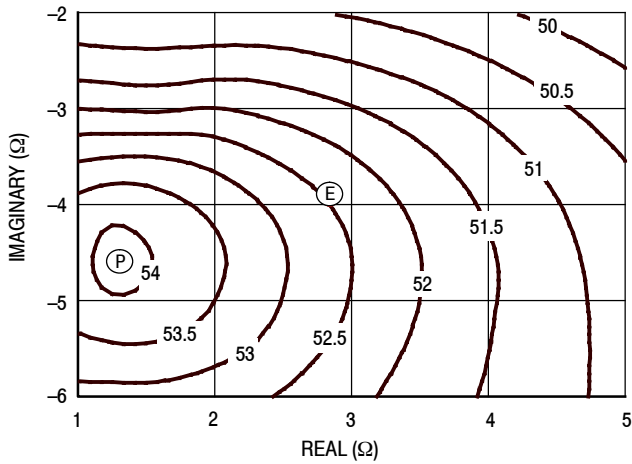

Figure 12. P3dB Load Pull Output Power Contours (dBm)

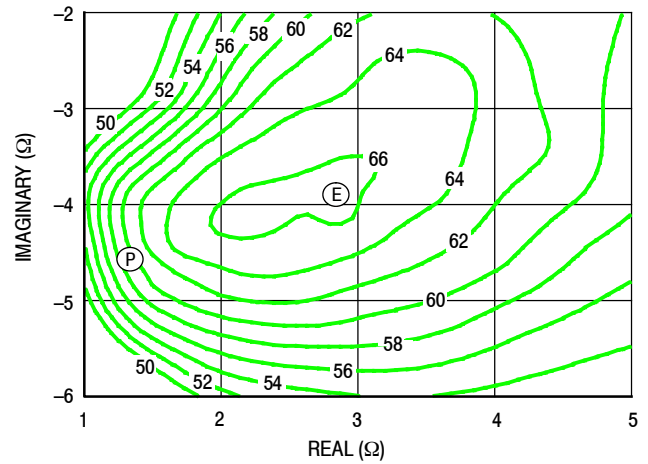

Figure 13. P3dB Load Pull Efficiency Contours (%)

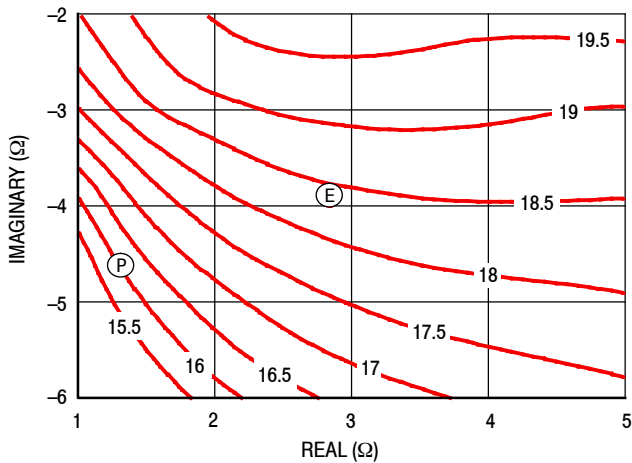

Figure 14. P3dB Load Pull Gain Contours (dB)

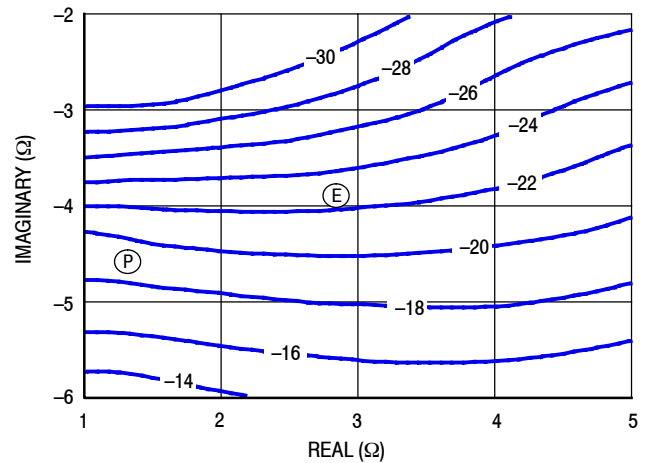

Figure 15. P3dB Load Pull AM/PM Contours (°)

NOTE: (P) = Maximum Output Power
(E) = Maximum Drain Efficiency

- Gain
- Drain Efficiency
- Linearity
- Output Power

P1dB – TYPICAL PEAKING SIDE LOAD PULL CONTOURS — 2140 MHz

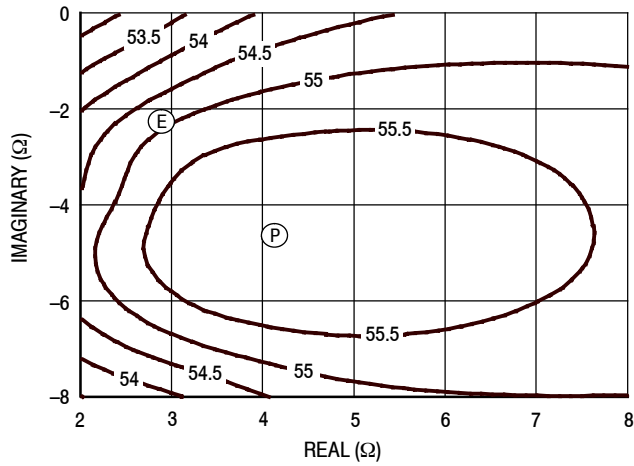

Figure 16. P1dB Load Pull Output Power Contours (dBm)

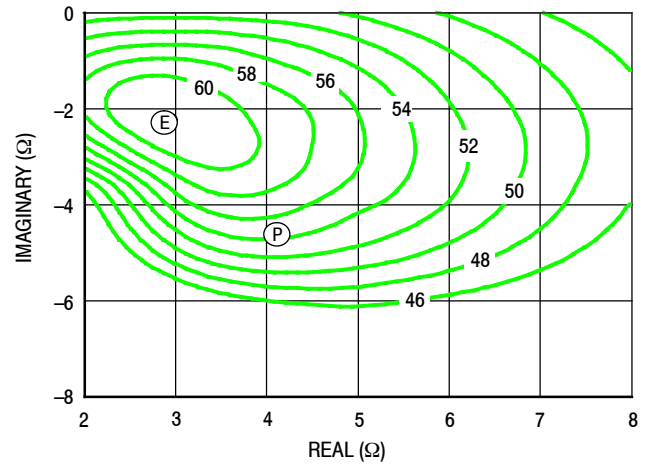

Figure 17. P1dB Load Pull Efficiency Contours (%)

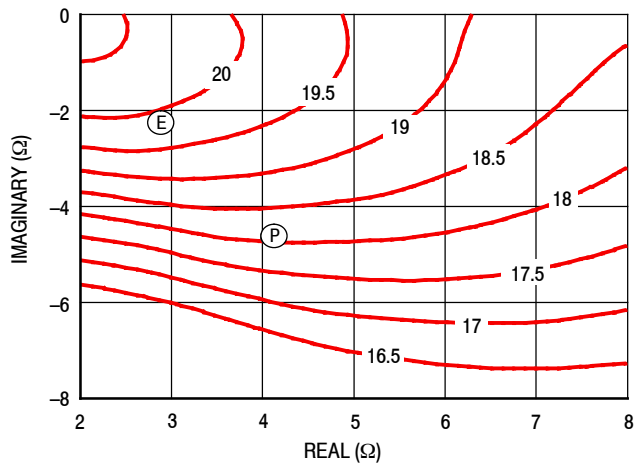

Figure 18. P1dB Load Pull Gain Contours (dB)

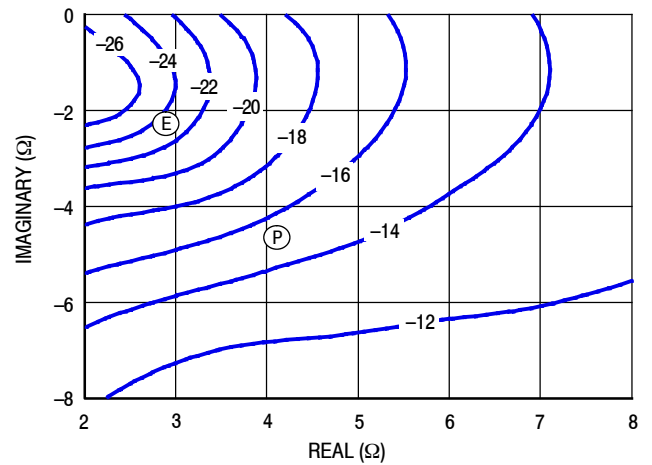

Figure 19. P1dB Load Pull AM/PM Contours (°)

NOTE: (P) = Maximum Output Power

(E) = Maximum Drain Efficiency

- Gain
- Drain Efficiency
- Linearity
- Output Power

P3dB – TYPICAL PEAKING SIDE LOAD PULL CONTOURS — 2140 MHz

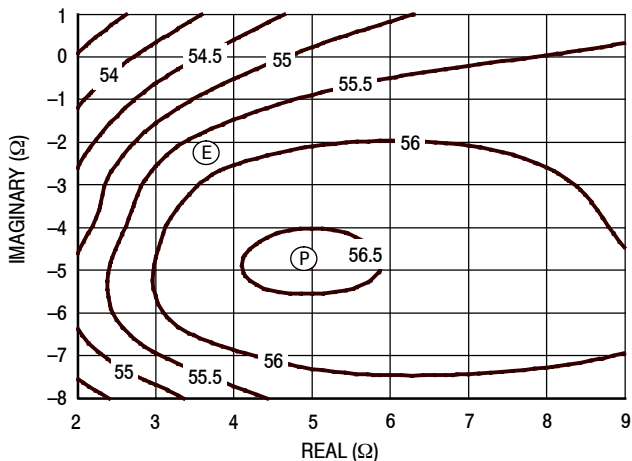

Figure 20. P3dB Load Pull Output Power Contours (dBm)

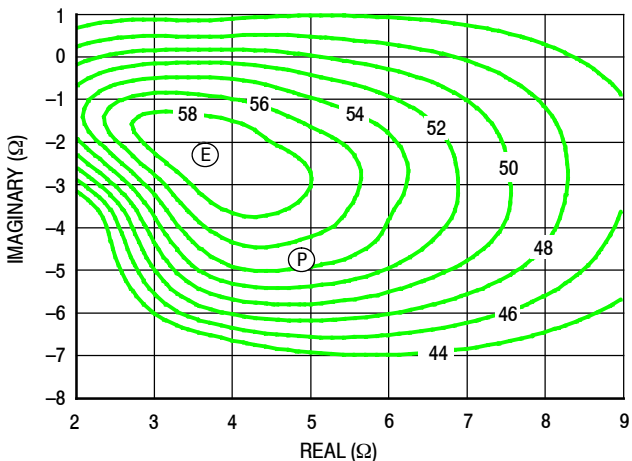

Figure 21. P3dB Load Pull Efficiency Contours (%)

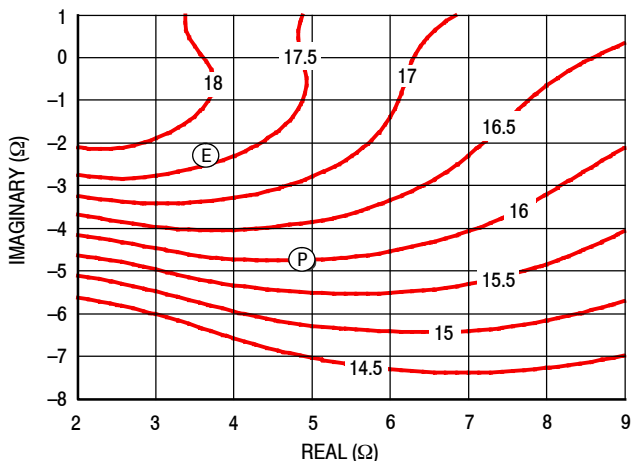

Figure 22. P3dB Load Pull Gain Contours (dB)

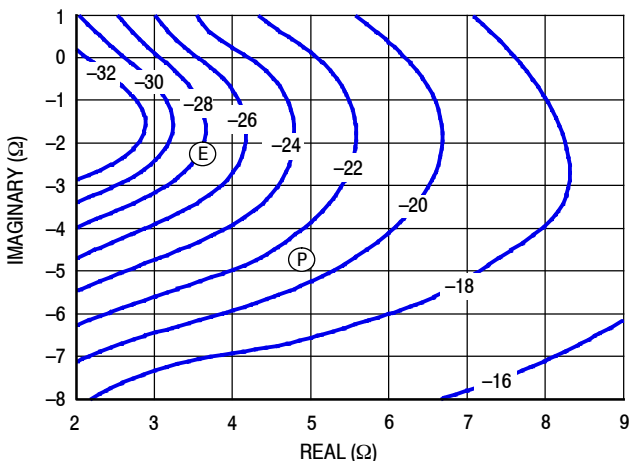

Figure 23. P3dB Load Pull AM/PM Contours (°)

NOTE: (P) = Maximum Output Power
 (E) = Maximum Drain Efficiency

- Gain
- Drain Efficiency
- Linearity
- Output Power

PACKAGE DIMENSIONS



© NXP SEMICONDUCTORS N. V. ALL RIGHTS RESERVED	MECHANICAL OUTLINE	PRINT VERSION NOT TO SCALE
TITLE: ACP-1230S-4L2S	DOCUMENT NO: 98ASA00974D	REV: A
	STANDARD: NON-JEDEC	
	SOT1800-4	21 JUN 2017

A3T21H450W23SR6

NOTES:

1. INTERPRET DIMENSIONS AND TOLERANCES PER ASME Y14.5M-1994.

2. CONTROLLING DIMENSION: INCH

3. DIMENSIONS H1 AND H2 ARE MEASURED .030 INCH (0.762 MM) AWAY FROM FLANGE PARALLEL TO DATUM B. H1 APPLIES TO PINS 1, 2, 4 & 5. H2 APPLIES TO PINS 3 & 6.

4. TOLERANCE OF DIMENSION H2 IS TENTATIVE.

5. THESE SURFACES OF THE HEAT SLUG ARE NOT PART OF THE SOLDERABLE SURFACES AND MAY REMAIN UNPLATED.

6. DATUM H IS LOCATED AT THE BOTTOM OF THE LEAD FRAME AND IS COINCIDENT WITH THE LEAD WHERE THE LEADS EXIT THE PLASTIC BODY.

7. DIMENSIONS M AND S DO NOT INCLUDE MOLD PROTRUSION. ALLOWABLE PROTRUSION IS .012 INCH (0.30 MM) PER SIDE. DIMENSIONS M AND S DO INCLUDE MOLD MISMATCH AND ARE DETERMINED AT DATUM PLANE H.

8. DIMENSIONS D, U AND K DO NOT INCLUDE DAMBAR PROTRUSION. ALLOWABLE DAMBAR PROTRUSION SHALL BE .010 INCH (0.25 MM) TOTAL IN EXCESS OF THE D, U AND K DIMENSION AT MAXIMUM MATERIAL CONDITION.

9. DATUM A AND B TO BE DETERMINED AT DATUM T.

DIM	INCHES		MILLIMETERS		DIM	INCHES		MILLIMETERS	
	MIN	MAX	MIN	MAX		MIN	MAX	MIN	MAX
AA	1.265	1.275	32.13	32.39	S	.365	.375	9.27	9.53
BB	.395	.405	10.03	10.29	U	.035	.045	0.89	1.14
CC	.160	.190	4.06	4.83	V1	.640	.655	16.26	16.64
D	.455	.465	11.56	11.81	W1	.105	.115	2.67	2.92
E	.062	.069	1.57	1.75	W2	.135	.145	3.43	3.68
F	.004	.007	0.10	0.18	W3	.245	.255	6.22	6.48
H1	.082	.090	2.08	2.29	W4	.265	.281	6.73	7.14
H2	.078	.094	1.98	2.39	Y	0.695 BSC		17.65 BSC	
K	.175	.195	4.45	4.95	Z1	R.000	R.040	R0.00	R1.02
L	0.270 BSC		6.86 BSC		Z2	.060	.100	1.52	2.54
M	1.219	1.241	30.96	31.52	aaa	.015		0.38	
N	1.218	1.242	30.94	31.55	bbb	.010		0.25	
R	.365	.375	9.27	9.53	ccc	.020		0.51	

© NXP SEMICONDUCTORS N.V.
ALL RIGHTS RESERVED

MECHANICAL OUTLINE

PRINT VERSION NOT TO SCALE

TITLE:

ACP-1230S-4L2S

DOCUMENT NO: 98ASA00974D

REV: A

STANDARD: NON-JEDEC

SOT1800-4

21 JUN 2017

PRODUCT DOCUMENTATION, SOFTWARE AND TOOLS

Refer to the following resources to aid your design process.

Application Notes

- AN1908: Solder Reflow Attach Method for High Power RF Devices in Air Cavity Packages
- AN1955: Thermal Measurement Methodology of RF Power Amplifiers

Engineering Bulletins

- EB212: Using Data Sheet Impedances for RF LDMOS Devices

Software

- Electromigration MTTF Calculator
- .s2p File

Development Tools

- Printed Circuit Boards

To Download Resources Specific to a Given Part Number:

1. Go to <http://www.nxp.com/RF>
2. Search by part number
3. Click part number link
4. Choose the desired resource from the drop down menu

REVISION HISTORY

The following table summarizes revisions to this document.

Revision	Date	Description
0	July 2017	• Initial release of data sheet
1	Aug. 2017	• Typical Characteristic 2110–2200 MHz performance graphs: added Figs. 3–7, pp. 5–6

How to Reach Us:

Home Page:
nxp.com

Web Support:
nxp.com/support

Information in this document is provided solely to enable system and software implementers to use NXP products. There are no express or implied copyright licenses granted hereunder to design or fabricate any integrated circuits based on the information in this document. NXP reserves the right to make changes without further notice to any products herein.

NXP makes no warranty, representation, or guarantee regarding the suitability of its products for any particular purpose, nor does NXP assume any liability arising out of the application or use of any product or circuit, and specifically disclaims any and all liability, including without limitation consequential or incidental damages. "Typical" parameters that may be provided in NXP data sheets and/or specifications can and do vary in different applications, and actual performance may vary over time. All operating parameters, including "typicals," must be validated for each customer application by customer's technical experts. NXP does not convey any license under its patent rights nor the rights of others. NXP sells products pursuant to standard terms and conditions of sale, which can be found at the following address: nxp.com/SalesTermsandConditions.

NXP, the NXP logo, Freescale, the Freescale logo, and Airfast are trademarks of NXP B.V. All other product or service names are the property of their respective owners.
© 2017 NXP B.V.



Компания «Life Electronics» занимается поставками электронных компонентов импортного и отечественного производства от производителей и со складов крупных дистрибьюторов Европы, Америки и Азии.

С конца 2013 года компания активно расширяет линейку поставок компонентов по направлению коаксиальный кабель, кварцевые генераторы и конденсаторы (керамические, пленочные, электролитические), за счёт заключения дистрибьюторских договоров

Мы предлагаем:

- Конкурентоспособные цены и скидки постоянным клиентам.
- Специальные условия для постоянных клиентов.
- Подбор аналогов.
- Поставку компонентов в любых объемах, удовлетворяющих вашим потребностям.
- Приемлемые сроки поставки, возможна ускоренная поставка.
- Доставку товара в любую точку России и стран СНГ.
- Комплексную поставку.
- Работу по проектам и поставку образцов.
- Формирование склада под заказчика.
- Сертификаты соответствия на поставляемую продукцию (по желанию клиента).
- Тестирование поставляемой продукции.
- Поставку компонентов, требующих военную и космическую приемку.
- Входной контроль качества.
- Наличие сертификата ISO.

В составе нашей компании организован Конструкторский отдел, призванный помогать разработчикам, и инженерам.

Конструкторский отдел помогает осуществить:

- Регистрацию проекта у производителя компонентов.
- Техническую поддержку проекта.
- Защиту от снятия компонента с производства.
- Оценку стоимости проекта по компонентам.
- Изготовление тестовой платы монтаж и пусконаладочные работы.



Тел: +7 (812) 336 43 04 (многоканальный)

Email: org@lifeelectronics.ru