



WIDEBAND MMIC VCO w/ BUFFER AMPLIFIER, 10 - 20 GHz

Typical Applications

Low Noise wideband MMIC VCO is ideal for:

- Industrial/Medical Equipment
- Test & Measurement Equipment
- Military Radar, EW & ECM

Features

- Wide Tuning Bandwidth
- Pout: +3 dBm
- Low SSB Phase Noise: -90 dBc/Hz @100 kHz
- No External Resonator Needed
- Single Positive Supply: +5V @ 70 mA
- RoHS Compliant 4 x 4 mm SMT Package

Functional Diagram

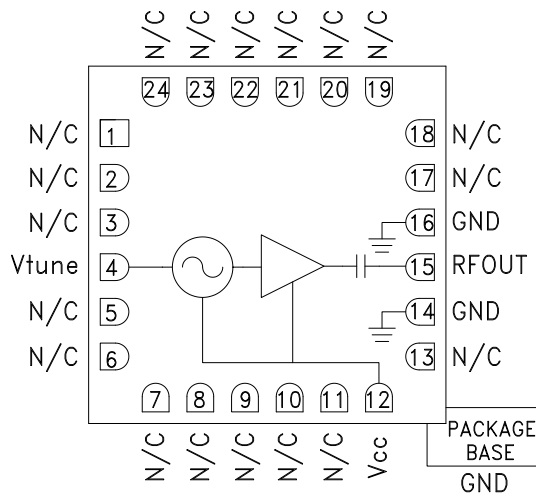

General Description

The HMC733LC4B is a wideband MMIC Voltage Controlled Oscillator which incorporates the resonator, negative resistance device, and varactor diode. Output power and phase noise performance are excellent over temperature due to the oscillator's monolithic construction. The Vtune port accepts an analog tuning voltage from 0 to +22V. The HMC733LC4B VCO operates from a single +5V supply, consumes only 70 mA of current, and is housed in a RoHS compliant SMT package. This wideband VCO uniquely combines the attributes of ultra small size, low phase noise, low power consumption, and wide tuning range.

Electrical Specifications, $T_A = +25^\circ\text{C}$, $V_{CC} = +5\text{V}$

Parameter	Min.	Typ.	Max.	Units
Frequency Range		10 - 20		GHz
Power Output		3		dBm
SSB Phase Noise @ 10 kHz Offset		-60		dBc/Hz
SSB Phase Noise @ 100 kHz Offset		-90		dBc/Hz
Tune Voltage (Vtune)	-0.25		23	V
Supply Current (Icc) (Vcc = +5V)		70		mA
Tune Port Leakage Current (Vtune = +23V)		25		μA
Output Return Loss		10		dB
2nd Harmonic		-20		dBc
Pulling (into a 2.0:1 VSWR)		15		MHz pp
Vcc Pushing, Vtune = +20V, F = 20 GHz		-90		MHz/V
Frequency Drift Rate @ 10 GHz		-0.25		MHz/ $^\circ\text{C}$
Frequency Drift Rate @ 20 GHz		-0.80		MHz/ $^\circ\text{C}$

Information furnished by Analog Devices is believed to be accurate and reliable. However, no responsibility is assumed by Analog Devices for its use, nor for any infringements of patents or other rights of third parties that may result from its use. Specifications subject to change without notice. No license is granted by implication or otherwise under any patent or patent rights of Analog Devices. Trademarks and registered trademarks are the property of their respective owners.

For price, delivery, and to place orders: Analog Devices, Inc., One Technology Way, P.O. Box 9106, Norwood, MA 02062-9106
Phone: 781-329-4700 • Order online at www.analog.com
Application Support: Phone: 1-800-ANALOG-D



WIDEBAND MMIC VCO w/ BUFFER AMPLIFIER, 10 - 20 GHz

Frequency vs. Tuning Voltage, Vcc = +5V

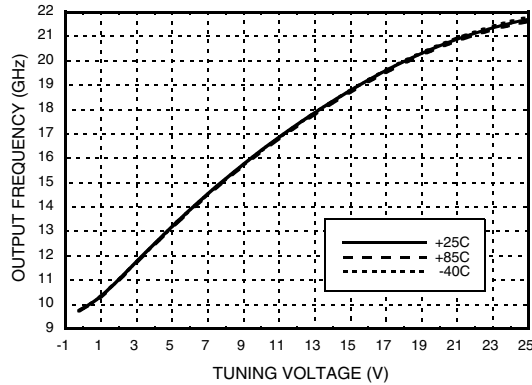

Frequency vs. Tuning Voltage, T = +25 °C

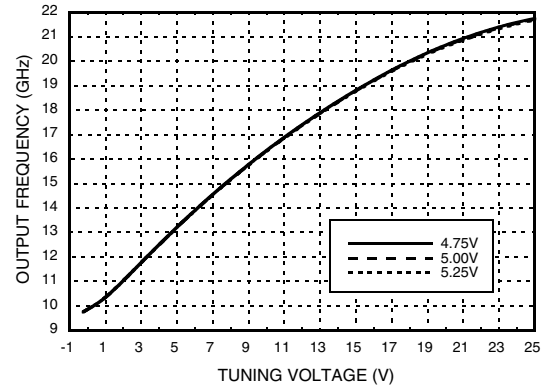

Sensitivity vs. Tuning Voltage, Vcc = +5V, T = +25 °C

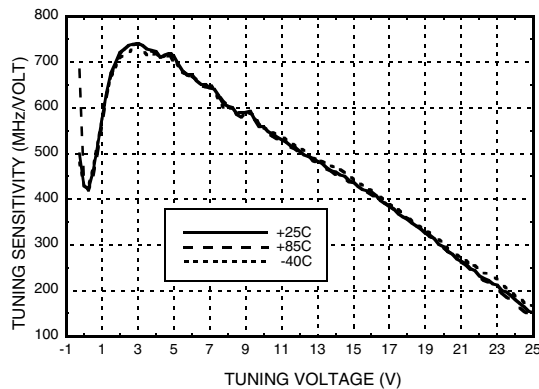

Output Power vs. Tuning Voltage, Vcc = +5V

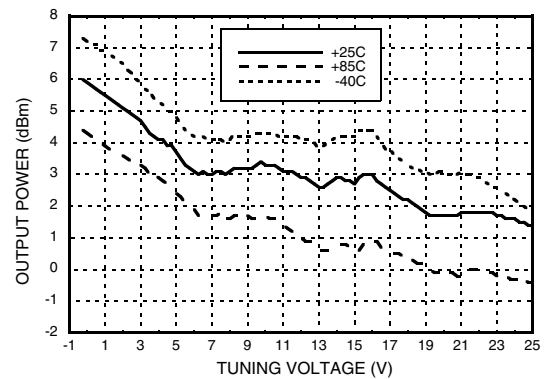

SSB Phase Noise vs. Tuning Voltage, T = +25 °C

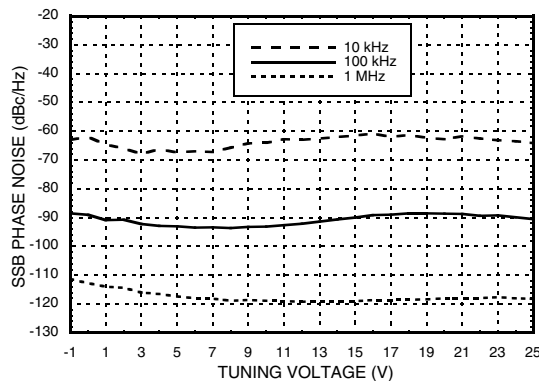

Typical SSB Phase Noise vs. Temperature Vtune = +10V

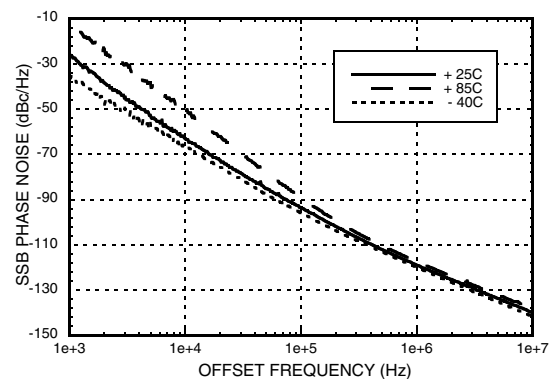



WIDEBAND MMIC VCO w/ BUFFER AMPLIFIER, 10 - 20 GHz

Supply Current vs. Vcc, T = +25 °C

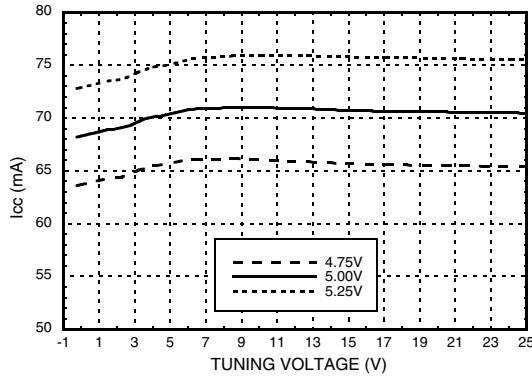

Absolute Maximum Ratings

Vcc	+5.5 Vdc
Vtune	-1.0 to +25V
Storage Temperature	-65 to +150 °C
ESD Sensitivity (HBM)	Class 1A

Reliability Information

Junction Temperature To Maintain 1 Million Hour MTTF	135 °C
Nominal Junction Temperature (T = 85 °C)	119 °C
Thermal Resistance (Junction to GND paddle, 5V supply)	97 °C/W
Operating Temperature	-40 °C to +85 °C



**ELECTROSTATIC SENSITIVE DEVICE
OBSERVE HANDLING PRECAUTIONS**

Outline Drawing

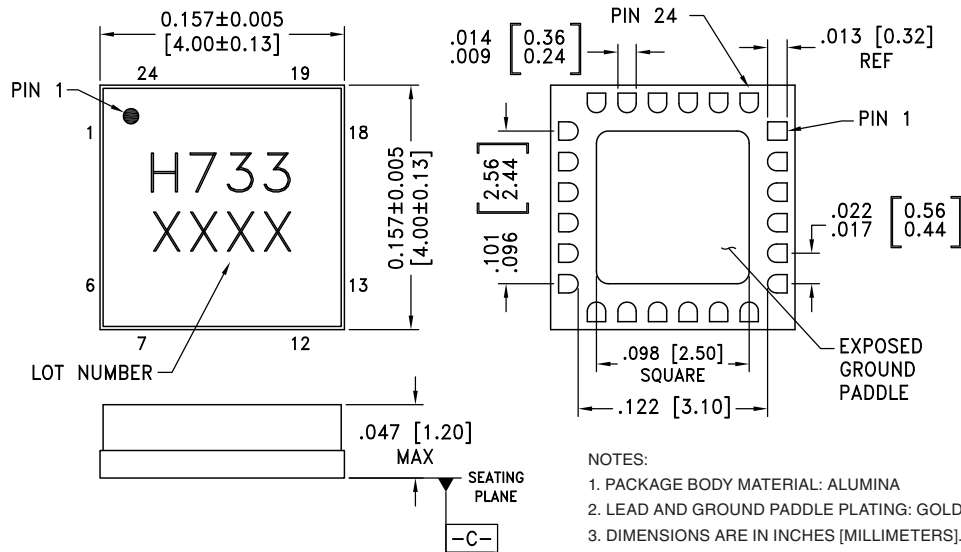

- NOTES:
1. PACKAGE BODY MATERIAL: ALUMINA
 2. LEAD AND GROUND PADDLE PLATING: GOLD FLASH OVER NI.
 3. DIMENSIONS ARE IN INCHES [MILLIMETERS].
 4. LEAD SPACING TOLERANCE IS NON-CUMULATIVE.
 5. PACKAGE WARP SHALL NOT EXCEED 0.05mm DATUM -C-
 6. ALL GROUND LEADS AND GROUND PADDLE MUST BE SOLDERED TO PCB RF GROUND.



Package Information

Part Number	Package Body Material	Lead Finish	MSL Rating	Package Marking [2]
HMC733LC4B	Alumina, White	Gold over Nickel	MSL3 [1]	H733 XXXX

[1] Max peak reflow temperature of 260 °C

[2] 4-Digit lot number XXXX

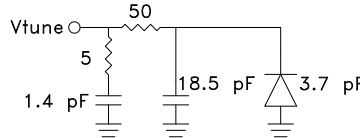
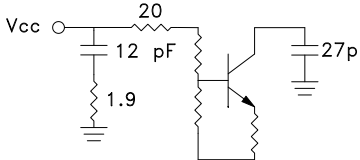

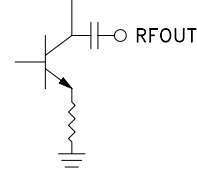
**WIDEBAND MMIC VCO w/ BUFFER
AMPLIFIER, 10 - 20 GHz**
Pin Descriptions

Pin Number	Function	Description	Interface Schematic
1 - 3, 5 - 11, 13, 17 - 24	N/C	No Connection. These pins may be connected to RF/DC ground. Performance will not be affected.	
4	Vtune	Control Voltage and Modulation Input. Modulation bandwidth dependent on drive source impedance.	
12	Vcc	Supply Voltage Vcc= +5V	
14, 16	GND	Package bottom has an exposed metal paddle that must also be RF & DC grounded.	
15	RFOUT	RF output (AC coupled)	

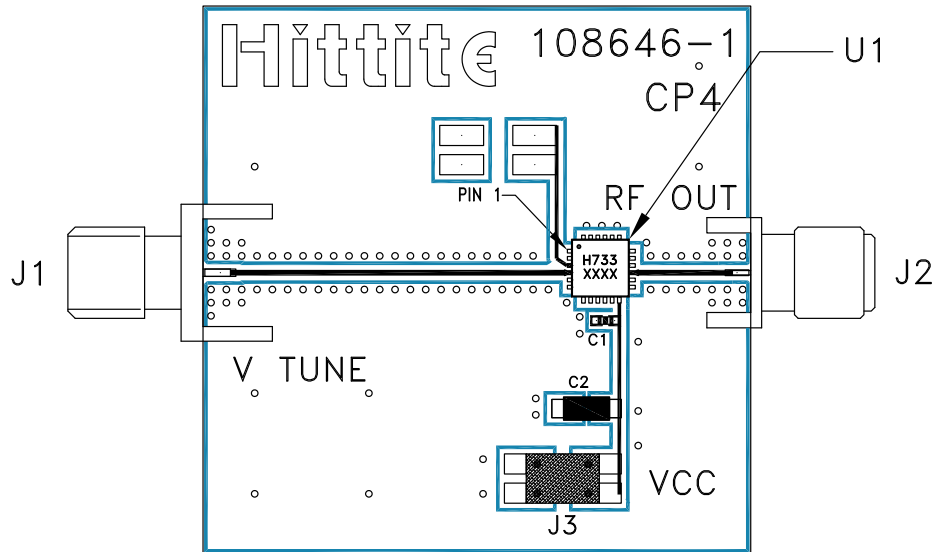

**WIDEBAND MMIC VCO w/ BUFFER
AMPLIFIER, 10 - 20 GHz**

Evaluation PCB



List of Materials for Evaluation PCB 108648 [1]

Item	Description
J1	PCB Mount SMA RF Connector, Johnson
J2	PCB Mount SMA Connector, SRI
J3	DC Header
C1	1000 pF Capacitor, 0402 Pkg.
C2	4.7 μF Capacitor, Tantalum
U1	HMC733LC4B VCO
PCB [2]	108646 Eval Board

[1] Reference this number when ordering complete evaluation PCB

[2] Circuit Board Material: Rogers 4350

The circuit board used in the application should use RF circuit design techniques. Signal lines should have 50 Ohm impedance while the package ground leads and exposed ground paddle should be connected directly to the ground plane similar to that shown. A sufficient number of via holes should be used to connect the top and bottom ground planes. The evaluation circuit board shown is available from Hittite upon request.

**WIDEBAND MMIC VCO w/ BUFFER
AMPLIFIER, 10 - 20 GHz**

Компания «Life Electronics» занимается поставками электронных компонентов импортного и отечественного производства от производителей и со складов крупных дистрибьюторов Европы, Америки и Азии.

С конца 2013 года компания активно расширяет линейку поставок компонентов по направлению коаксиальный кабель, кварцевые генераторы и конденсаторы (керамические, пленочные, электролитические), за счёт заключения дистрибьюторских договоров

Мы предлагаем:

- Конкурентоспособные цены и скидки постоянным клиентам.
- Специальные условия для постоянных клиентов.
- Подбор аналогов.
- Поставку компонентов в любых объемах, удовлетворяющих вашим потребностям.
- Приемлемые сроки поставки, возможна ускоренная поставка.
- Доставку товара в любую точку России и стран СНГ.
- Комплексную поставку.
- Работу по проектам и поставку образцов.
- Формирование склада под заказчика.
- Сертификаты соответствия на поставляемую продукцию (по желанию клиента).
- Тестирование поставляемой продукции.
- Поставку компонентов, требующих военную и космическую приемку.
- Входной контроль качества.
- Наличие сертификата ISO.

В составе нашей компании организован Конструкторский отдел, призванный помогать разработчикам, и инженерам.

Конструкторский отдел помогает осуществить:

- Регистрацию проекта у производителя компонентов.
- Техническую поддержку проекта.
- Защиту от снятия компонента с производства.
- Оценку стоимости проекта по компонентам.
- Изготовление тестовой платы монтаж и пусконаладочные работы.



Тел: +7 (812) 336 43 04 (многоканальный)

Email: org@lifeelectronics.ru