

PROTECTION PRODUCTS - Z-Pak™
Description

μ Clamp[®] TVS diodes are designed to protect sensitive electronics from damage or latch-up due to ESD. It is designed to replace 0201 size multilayer varistors (MLVs) in portable applications such as cell phones, notebook computers, and other portable electronics. It features large cross-sectional area junctions for conducting high transient currents. This device offers desirable characteristics for board level protection including fast response time, low operating and clamping voltage, and no device degradation.

μ Clamp[®]0541Z is in a 2-pin SLP0603P2X3 package. It measures 0.6 x 0.3 mm with a nominal height of only 0.25mm. Leads are finished with lead-free NiAu. Each device will protect one line operating at 5 volts. It gives the designer the flexibility to protect single lines in applications where arrays are not practical. The combination of small size and high ESD surge capability makes them ideal for use in portable applications such as cellular phones, digital cameras, and MP3 players.

Features

- ◆ High ESD withstand Voltage: **+/-17kV** (Contact/Air) per **IEC 61000-4-2**
- ◆ Able to withstand over 1000 ESD strikes per IEC 61000-4-2 Level 4
- ◆ Ultra-small **0201 package**
- ◆ Protects one data or power line
- ◆ Low reverse current: <10nA typical (VR=5V)
- ◆ Working voltage: +/- 5V
- ◆ Low capacitance: 6.5pF typical
- ◆ Solid-state silicon-avalanche technology

Mechanical Characteristics

- ◆ SLP0603P2X3 package
- ◆ Pb-Free, Halogen Free, RoHS/WEEE Compliant
- ◆ Nominal Dimensions: 0.6 x 0.3 x 0.25 mm
- ◆ Lead Finish: NiAu
- ◆ Marking : Marking code + dot matrix date code
- ◆ Packaging : Tape and Reel

Applications

- ◆ Cellular Handsets & Accessories
- ◆ Keypads, Side Keys, Audio Ports
- ◆ Portable Instrumentation
- ◆ Digital Lines
- ◆ Tablet PC

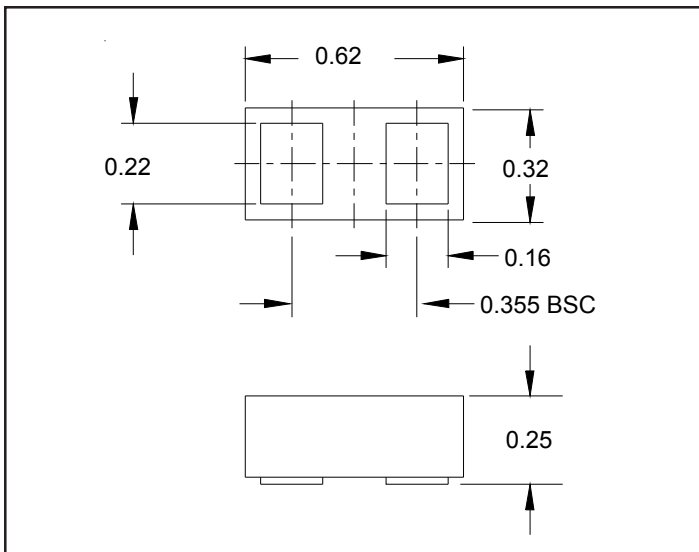
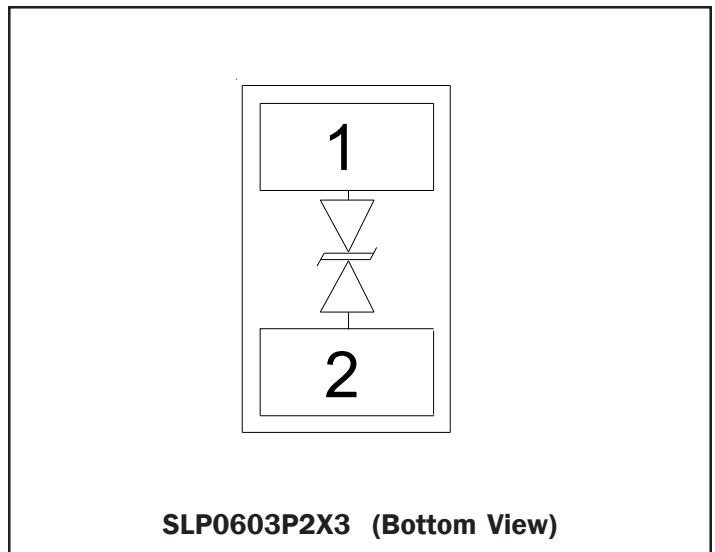
Nominal Dimensions

Schematic

PROTECTION PRODUCTS
Absolute Maximum Rating

Rating	Symbol	Value	Units
Peak Pulse Power (tp = 8/20μs)	P_{pk}	25	Watts
Maximum Peak Pulse Current (tp = 8/20μs)	I_{pp}	2	Amps
ESD per IEC 61000-4-2 (Air) ¹ ESD per IEC 61000-4-2 (Contact) ¹	V_{ESD}	+/- 17 +/- 17	kV
Operating Temperature	T_J	-55 to +125	°C
Storage Temperature	T_{STG}	-55 to +150	°C

Electrical Characteristics (T=25°C)

Parameter	Symbol	Conditions	Minimum	Typical	Maximum	Units
Reverse Stand-Off Voltage	V_{RWM}	Pin 1 to 2 or 2 to 1			5	V
Reverse Breakdown Voltage	V_{BR}	$I_t = 1mA$ Pin 1 to 2 or 2 to 1	6	8.2	9.5	V
Reverse Leakage Current	I_R	$V_{RWM} = 5V, T=25°C$ Pin 1 to 2 or 2 to 1		3	50	nA
Clamping Voltage	V_C	$I_{pp} = 1A, tp = 8/20μs$ Pin 1 to 2 or 2 to 1			12	V
Clamping Voltage	V_C	$I_{pp} = 2A, tp = 8/20μs$ Pin 1 to 2 or 2 to 1			15	V
Dynamic Resistance ^{2, 3}	R_{DYN}	tlp = 0.2 / 100ns		0.78		Ohms
Junction Capacitance	C_J	$V_R = 0V, f = 1MHz$		6.5	9	pF

Notes

- 1)ESD gun return path connected to ESD ground reference plane.
- 2)Transmission Line Pulse Test (TLP) Settings: $t_p = 100ns, t_r = 0.2ns, I_{TLP}$ and V_{TLP} averaging window: $t_1 = 70ns$ to $t_2 = 90ns$.
- 3) Dynamic resistance calculated from $I_{TLP} = 4A$ to $I_{TLP} = 16A$

PROTECTION PRODUCTS

Typical Characteristics

Non-Repetitive Peak Pulse Power vs. Pulse Time

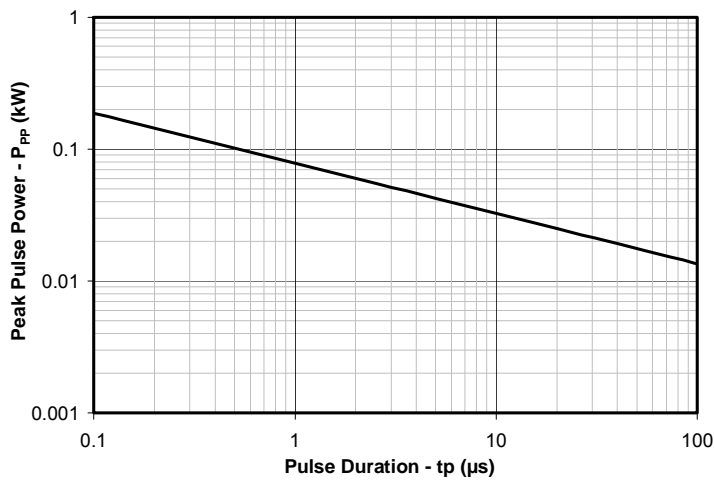

Clamping Voltage vs. Peak Pulse Current (t_p=8/20μs)

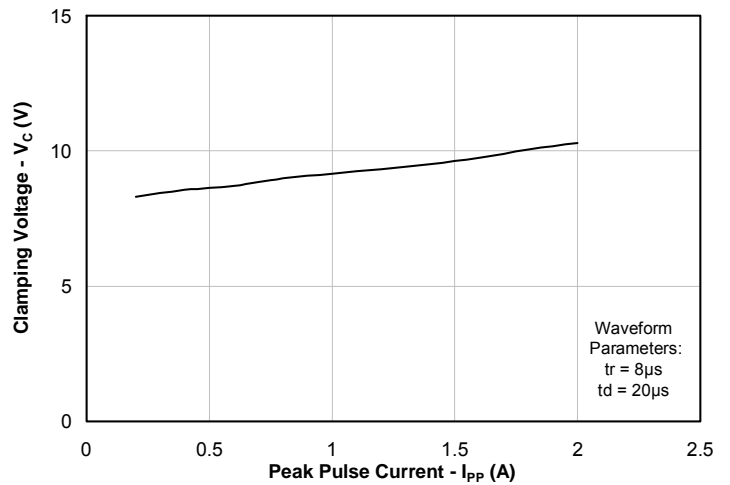

Junction Capacitance vs. Reverse Voltage

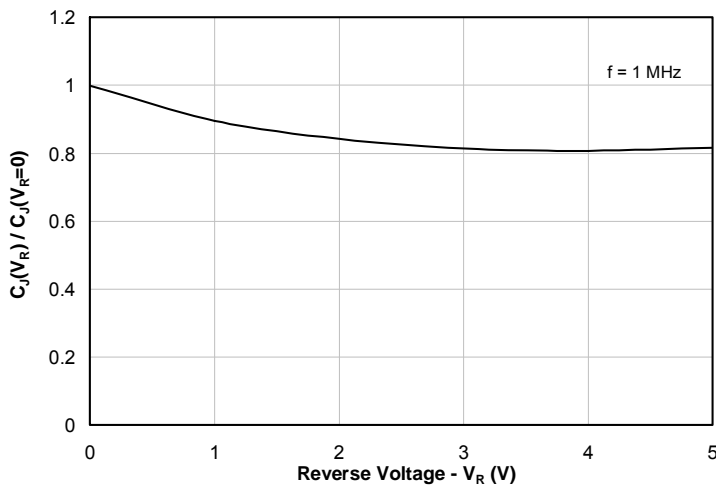

TLP Characteristic

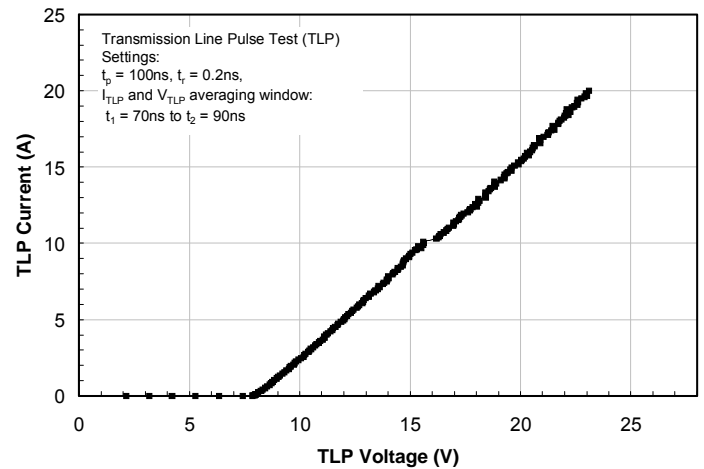

ESD Clamping (+8kV Contact per IEC 61000-4-2)

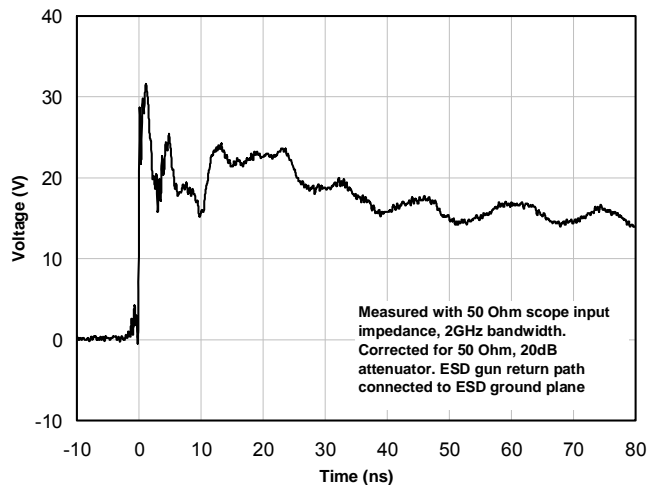

ESD Clamping (-8kV Contact per IEC 61000-4-2)

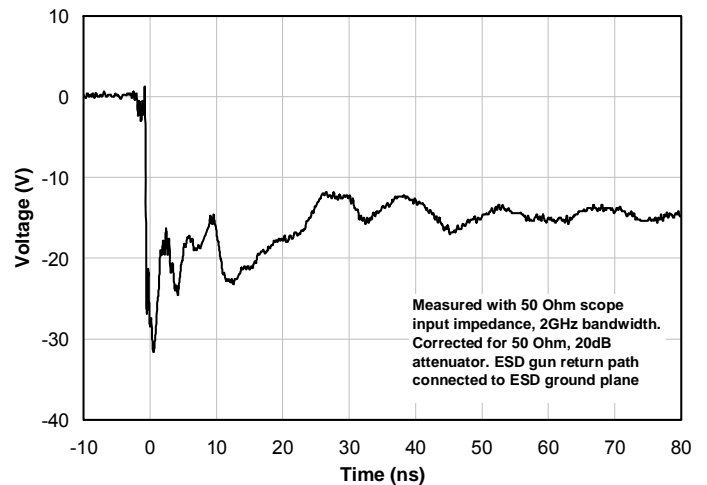

PROTECTION PRODUCTS

Typical Characteristics

Typical Insertion Loss S21

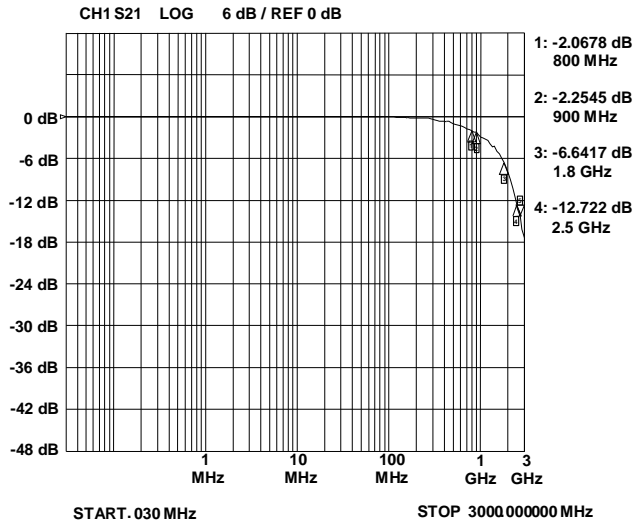

Applications Information

Assembly Guidelines

The small size of this device means that some care must be taken during the mounting process to insure reliable solder joint. The table below provides Semtech's recommended assembly guidelines for mounting this device. The figure at the right details Semtech's recommended aperture based on the below recommendations. Note that these are only recommendations and should serve only as a starting point for design since there are many factors that affect the assembly process. The exact manufacturing parameters will require some experimentation to get the desired solder application.

Assembly Parameter	Recommendation
Solder Stencil Design	Laser cut, Electro-polished
Aperture shape	Rectangular with rounded corners
Solder Stencil Thickness	0.100 mm (0.004")
Solder Paste Type	Type 4 size sphere or smaller
Solder Reflow Profile	Per JEDEC J-STD-020
PCB Solder Pad Design	Non-Solder mask defined
PCB Pad Finish	OSP OR NiAu

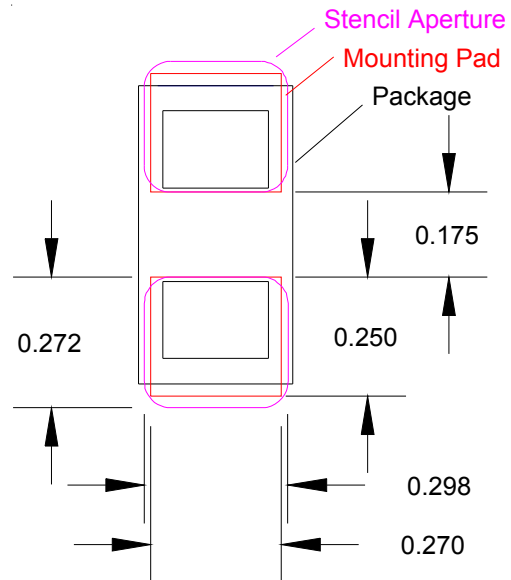

Recommended Mounting Pattern

PROTECTION PRODUCTS

Outline Drawing - SLP0603P2X3

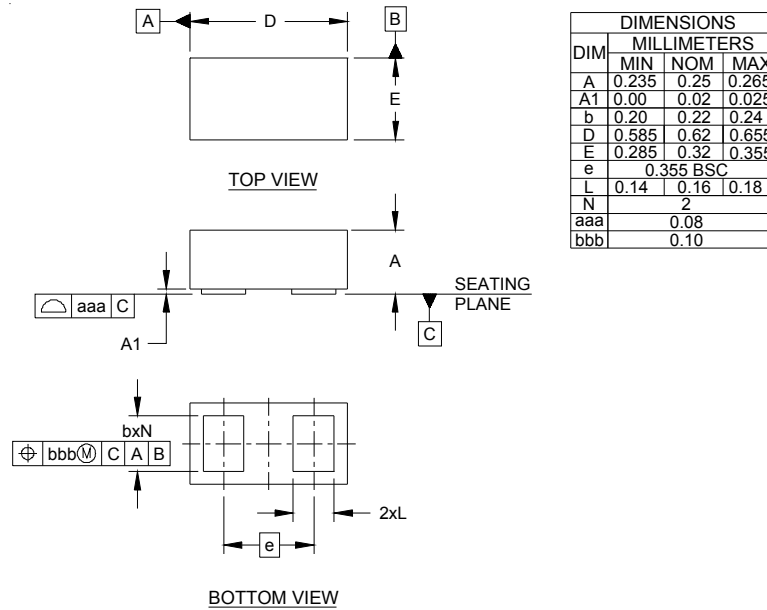

NOTES:
 1. CONTROLLING DIMENSIONS ARE IN MILLIMETERS (ANGLES IN DEGREES).

Land Pattern - SLP0603P2X3

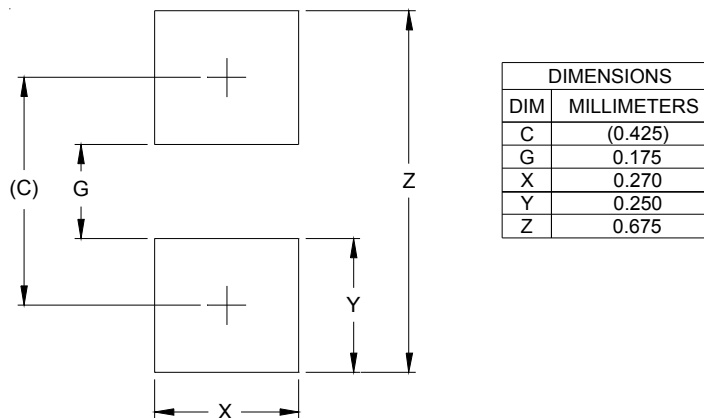

NOTES:
 1. CONTROLLING DIMENSIONS ARE IN MILLIMETERS (ANGLES IN DEGREES).
 2. THIS LAND PATTERN IS FOR REFERENCE PURPOSES ONLY.
 CONSULT YOUR MANUFACTURING GROUP TO ENSURE YOUR COMPANY'S MANUFACTURING GUIDELINES ARE MET.

PROTECTION PRODUCTS

Marking Code

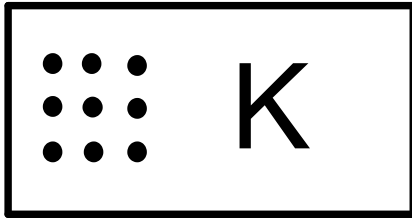

Notes:

1) Dots represent matrix date code

Ordering Information

Ordering Number	Qty per Reel	Carrier Tape	Reel Size	Comments
uClamp0541Z.TNT	10,000	Plastic	7 Inch	Not Recommended for New Designs
uClamp0541Z.TFT	15,000	Paper	7 Inch	
uClamp0541Z.TVT	50,000	Paper	13 Inch	

Notes:

1) MicroClamp, uClamp and μ Clamp are trademarks of Semtech Corporation

PROTECTION PRODUCTS

Carrier Tape Specification

Plastic Tape

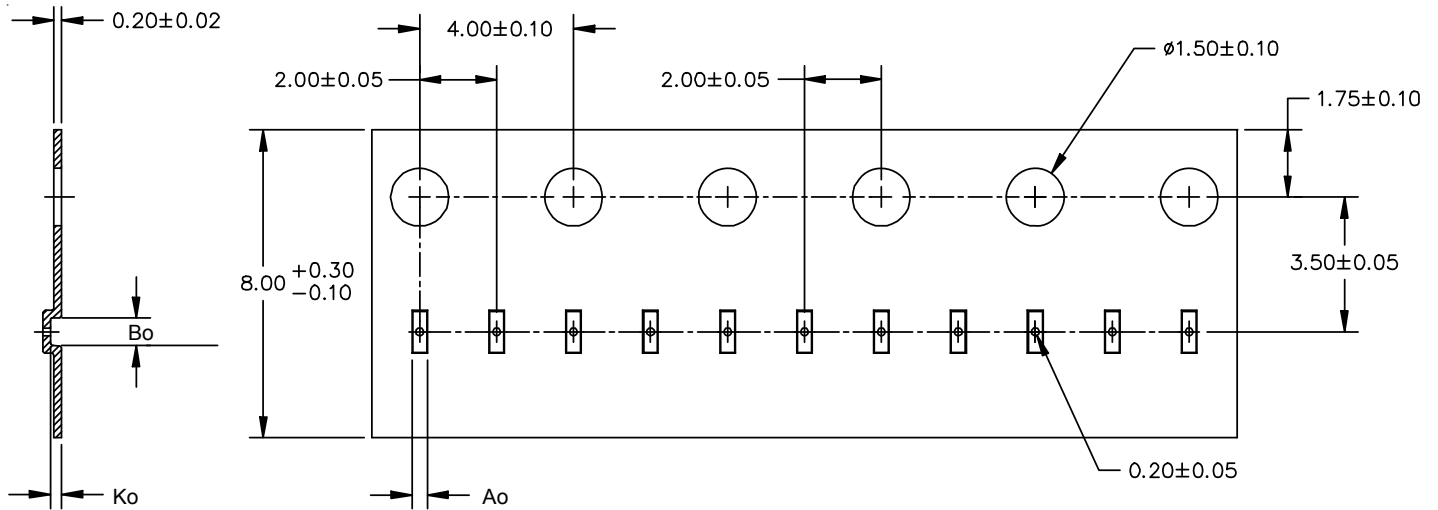

Paper Tape

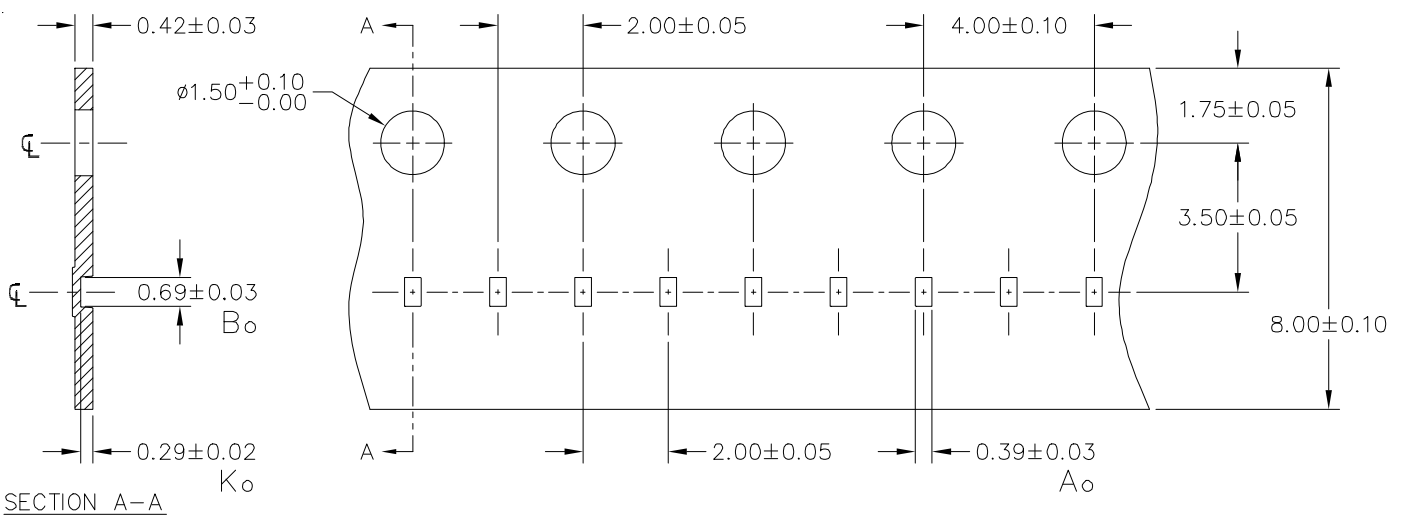

SECTION A-A

Note: All dimensions in mm unless otherwise specified

Device Orientation in Tape

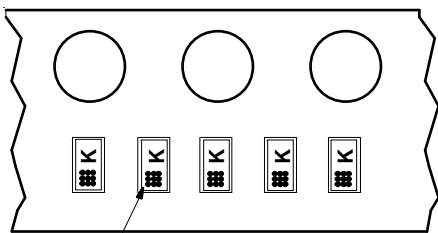

Date Code Location
(Away from Sprocket Holes)

Contact Information

Semtech Corporation
Protection Products Division
200 Flynn Rd., Camarillo, CA 93012
Phone: (805)498-2111 FAX (805)498-3804

Компания «Life Electronics» занимается поставками электронных компонентов импортного и отечественного производства от производителей и со складов крупных дистрибьюторов Европы, Америки и Азии.

С конца 2013 года компания активно расширяет линейку поставок компонентов по направлению коаксиальный кабель, кварцевые генераторы и конденсаторы (керамические, пленочные, электролитические), за счёт заключения дистрибьюторских договоров

Мы предлагаем:

- Конкурентоспособные цены и скидки постоянным клиентам.
- Специальные условия для постоянных клиентов.
- Подбор аналогов.
- Поставку компонентов в любых объемах, удовлетворяющих вашим потребностям.
- Приемлемые сроки поставки, возможна ускоренная поставка.
- Доставку товара в любую точку России и стран СНГ.
- Комплексную поставку.
- Работу по проектам и поставку образцов.
- Формирование склада под заказчика.
- Сертификаты соответствия на поставляемую продукцию (по желанию клиента).
- Тестирование поставляемой продукции.
- Поставку компонентов, требующих военную и космическую приемку.
- Входной контроль качества.
- Наличие сертификата ISO.

В составе нашей компании организован Конструкторский отдел, призванный помогать разработчикам, и инженерам.

Конструкторский отдел помогает осуществить:

- Регистрацию проекта у производителя компонентов.
- Техническую поддержку проекта.
- Защиту от снятия компонента с производства.
- Оценку стоимости проекта по компонентам.
- Изготовление тестовой платы монтаж и пусконаладочные работы.



Тел: +7 (812) 336 43 04 (многоканальный)

Email: org@lifeelectronics.ru