

LuxiGen Multi-Color Emitter Series  
LZ4 RGBW Flat Lens Emitter

# LZ4-04MDC9



## Key Features

- RGBW multi-channel surface mount ceramic LED package with integrated flat glass lens
- Individually addressable Red, Green, Blue and Daylight White die
- Designed to minimize étendue going into secondary optics system
- Thermal resistance of 2.8°C/W; 1.0A maximum current
- Small foot print – 7.0mm x 7.0mm
- Anodes and cathodes are aligned to simplify connection of multiple emitters
- Electrically neutral thermal path
- JEDEC Level 1 for Moisture Sensitivity Level
- Lead (Pb) free and RoHS compliant
- Reflow solderable (up to 6 cycles)

## Typical Applications

- Stage and Studio Lighting
- Effect Lighting
- Accent Lighting
- Display Lighting
- Architectural Lighting

## Description

The LZ4 RGBW flat lens emitter contains one red, green, blue and daylight white LED dies closely packed in a low thermal resistance package with integrated flat glass window. This design minimizes the étendue going into secondary optics, which allows lighting designer to produce narrower beams with better color mixing and no fringes. Utilizing a flat glass lens allows the secondary optics to be closer to the die, protecting it and facilitating the use of zoom optics, mixing rods, light pipes and other optics. The high quality materials used in the package are chosen to maximize light output and minimize stresses which results in monumental reliability and lumen maintenance.

## Part number options

### Base part number

Part number	Description
LZ4-04MDC9-0000	LZ4 RGBW flat lens emitter
LZ4-64MDC9-0000	LZ4 RGBW flat lens emitter on Standard Star 4 channel MCPCB

### Bin kit option codes

MD, Red-Green-Blue-White (6500K)			
Kit number suffix	Min flux Bin	Color Bin Ranges	Description
0000	07R	R01 – R01	Red, full distribution flux; full distribution wavelength
	10G	G2 – G3	Green, full distribution flux; full distribution wavelength
	09B	B03 – B03	Blue, full distribution flux; full distribution wavelength
	06W	1V2U	White full distribution flux and CCT

## Daylight White Chromaticity Groups

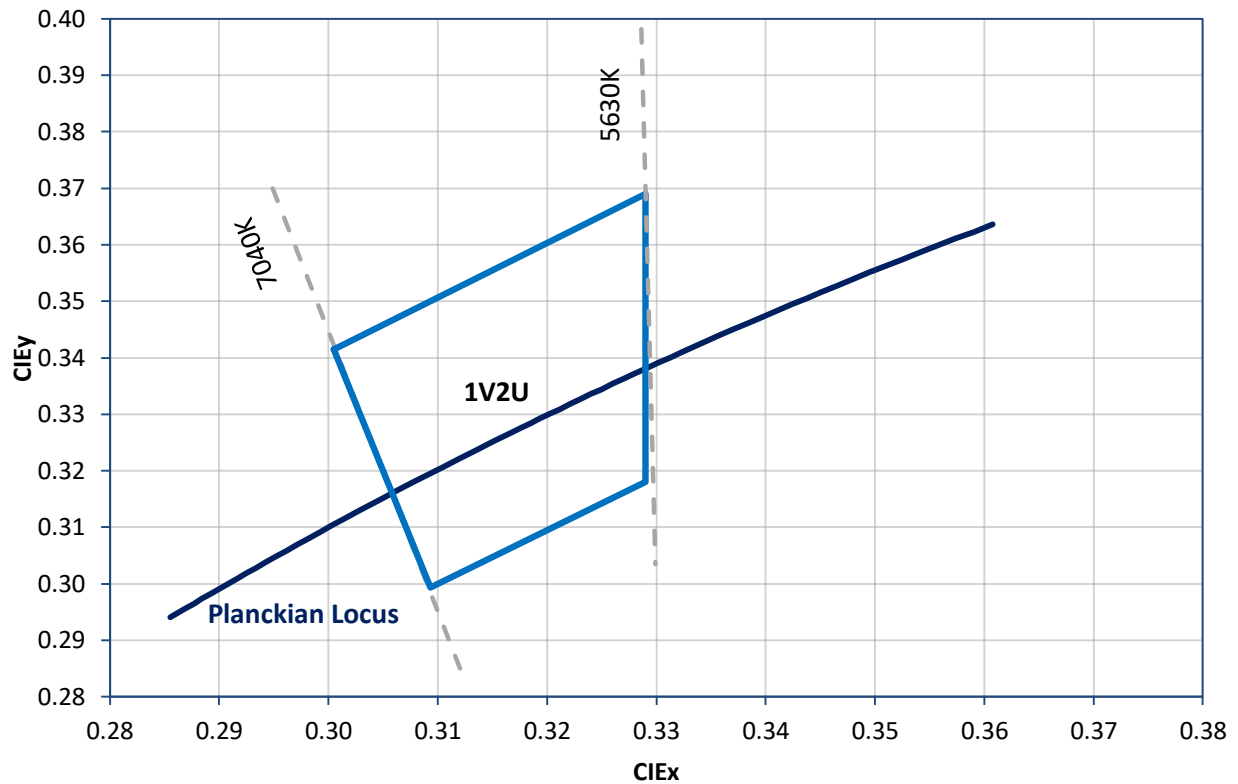

Standard Chromaticity Groups plotted on excerpt from the CIE 1931 (2°) x-y Chromaticity Diagram. Coordinates are listed below.

## Daylight White Bin Coordinates

Bin Code	CIE <sub>x</sub>	CIE <sub>y</sub>
1V2U	0.3005	0.3415
	0.329	0.369
	0.329	0.318
	0.3093	0.2993
	0.3005	0.3415

## Luminous Flux Bins

Table 1:

Bin Code	Minimum Luminous Flux ( $\Phi_v$ ) @ $I_f = 700\text{mA}$ <sup>[1,2]</sup> (lm)				Maximum Luminous Flux ( $\Phi_v$ ) @ $I_f = 700\text{mA}$ <sup>[1,2]</sup> (lm)			
	Red	Green	Blue	White	Red	Green	Blue	White
	07R	60				105		
10G		100				166		
09B			13				22	
10B			22				35	
06W				140				225

Notes for Table 1:

1. Luminous flux performance guaranteed within published operating conditions. LED Engin maintains a tolerance of  $\pm 10\%$  on flux measurements.

## Dominant Wavelength Bins

Table 2:

Bin Code	Minimum Dominant Wavelength ( $\lambda_D$ ) @ $I_f = 700\text{mA}$ <sup>[1]</sup> (nm)			Maximum Dominant Wavelength ( $\lambda_D$ ) @ $I_f = 700\text{mA}$ <sup>[1]</sup> (nm)		
	Red	Green	Blue	Red	Green	Blue
	R01	617			630	
G2		520			525	
G3		525			530	
B03			453			460

Notes for Table 2:

1. LED Engin maintains a tolerance of  $\pm 1.0\text{nm}$  on dominant wavelength measurements.

## Forward Voltage Bin

Table 3:

Bin Code	Minimum Forward Voltage ( $V_f$ ) @ $I_f = 700\text{mA}$ <sup>[1]</sup> (V)				Maximum Forward Voltage ( $V_f$ ) @ $I_f = 700\text{mA}$ <sup>[1]</sup> (V)			
	Red	Green	Blue	White	Red	Green	Blue	White
	0	2.10	3.20	2.80	2.80	2.90	4.20	3.80

Notes for Table 3:

1. LED Engin maintains a tolerance of  $\pm 0.04\text{V}$  on forward voltage measurements.

## Absolute Maximum Ratings

Table 4:

Parameter	Symbol	Value	Unit
DC Forward Current (@ $T_J = 125^\circ\text{C}$ ) <sup>[1]</sup>	$I_F$	1000	mA
Peak Pulsed Forward Current <sup>[2]</sup>	$I_{FP}$	1500	mA
Reverse Voltage	$V_R$	See Note 3	V
Storage Temperature	$T_{std}$	-40 ~ +150	$^\circ\text{C}$
Junction Temperature	$T_J$	125	$^\circ\text{C}$
Soldering Temperature <sup>[4]</sup>	$T_{sol}$	260	$^\circ\text{C}$
Allowable Reflow Cycles		6	
ESD Sensitivity <sup>[5]</sup>		> 8,000 V HBM Class 3B JESD22-A114-D	

Notes for Table 4:

- Maximum DC forward current is determined by the overall thermal resistance and ambient temperature. Follow the curves in Figure 11 for current derating.
- Pulse forward current conditions: Pulse Width  $\leq 10\text{msec}$  and Duty Cycle  $\leq 10\%$ .
- LEDs are not designed to be reversing biased.
- Solder conditions per JEDEC 020D. See Reflow Soldering Profile Figure 4.
- LED Engin recommends taking reasonable precautions towards possible ESD damages and handling the emitter in an electrostatic protected area (EPA). An EPA may be adequately protected by ESD controls as outlined in ANSI/ESD S6.1.

## Optical Characteristics @ $T_C = 25^\circ\text{C}$

Table 5:

Parameter	Symbol	Typical				Unit
		Red	Green	Blue <sup>[1]</sup>	White	
Luminous Flux (@ $I_F = 700\text{mA}$ )	$\Phi_V$	79	140	33	210	lm
Luminous Flux (@ $I_F = 1000\text{mA}$ )	$\Phi_V$	110	180	43	285	lm
Dominant Wavelength		623	523	457		
Correlated Color Temperature	CCT				6500	K
Color Rendering Index (CRI)	$R_a$				75	
Viewing Angle <sup>[2]</sup>	$2\Theta_{\frac{1}{2}}$		110			
Total Included Angle <sup>[3]</sup>	$\Theta_{0.9}$		150			Degrees

Notes for Table 5:

- When operating the Blue LED, observe IEC 60825-1 class 2 rating. Do not stare into the beam.
- Viewing Angle is the off axis angle from emitter centerline where the luminous intensity is  $\frac{1}{2}$  of the peak value.
- Total Included Angle is the total angle that includes 90% of the total luminous flux.

## Electrical Characteristics @ $T_C = 25^\circ\text{C}$

Table 6:

Parameter	Symbol	Typical				Unit
		Red	Green	Blue	White	
Forward Voltage (@ $I_F = 700\text{mA}$ )	$V_F$	2.5	3.6	3.2	3.2	V
Temperature Coefficient of Forward Voltage	$\Delta V_F / \Delta T_J$	-1.9	-2.9	-2.0	-2.0	mV/ $^\circ\text{C}$
Thermal Resistance (Junction to Case)	$R_{\Theta_{J-C}}$		2.8			$^\circ\text{C}/\text{W}$

## IPC/JEDEC Moisture Sensitivity Level

Table 7 - IPC/JEDEC J-STD-20D.1 MSL Classification:

Level	Floor Life		Soak Requirements			
	Time	Conditions	Standard	Accelerated	Standard	Accelerated
	Time	Conditions	Time (hrs)	Conditions	Time (hrs)	Conditions
1	Unlimited	≤ 30°C/ 85% RH	168 +5/-0	85°C/ 85% RH	n/a	n/a

Notes for Table 7:

- The standard soak time includes a default value of 24 hours for semiconductor manufacturer's exposure time (MET) between bake and bag and includes the maximum time allowed out of the bag at the distributor's facility.

## Average Lumen Maintenance Projections

Lumen maintenance generally describes the ability of a lamp to retain its output over time. The useful lifetime for solid state lighting devices (Power LEDs) is also defined as Lumen Maintenance, with the percentage of the original light output remaining at a defined time period.

Based on long-term WHTOL testing, LED Engin projects that the LZ Series will deliver, on average, 70% Lumen Maintenance at 65,000 hours of operation at a forward current of 700mA. This projection is based on constant current operation with junction temperature maintained at or below 125°C for LZ4 product.

## Mechanical Dimensions (mm)

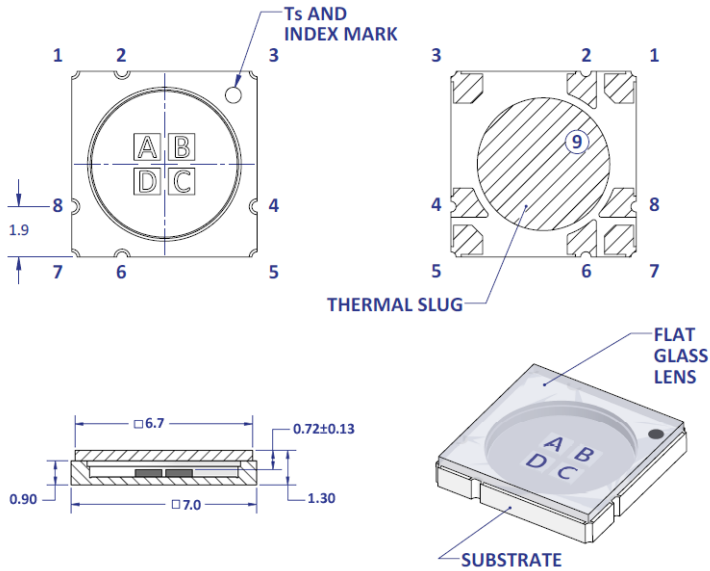

Pin Out			
Pad	Die	Color	Function
1	A	Green	Anode
2	D	Blue	Anode
3	B	Red	Anode
4	C	White	Anode
5	C	White	Cathode
6	B	Red	Cathode
7	D	Blue	Cathode
8	A	Green	Cathode
9 <sup>[2]</sup>	n/a	n/a	Thermal

Figure 1: Package Outline Drawing

Notes for Figure 1:

1. Unless otherwise noted, the tolerance =  $\pm 0.20$  mm.
2. Nominal die spacing is 0.15mm.
3. Thermal contact, Pad 9, is electrically neutral.

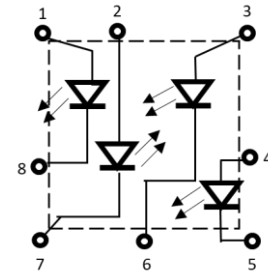

## Recommended Solder Pad Layout (mm)

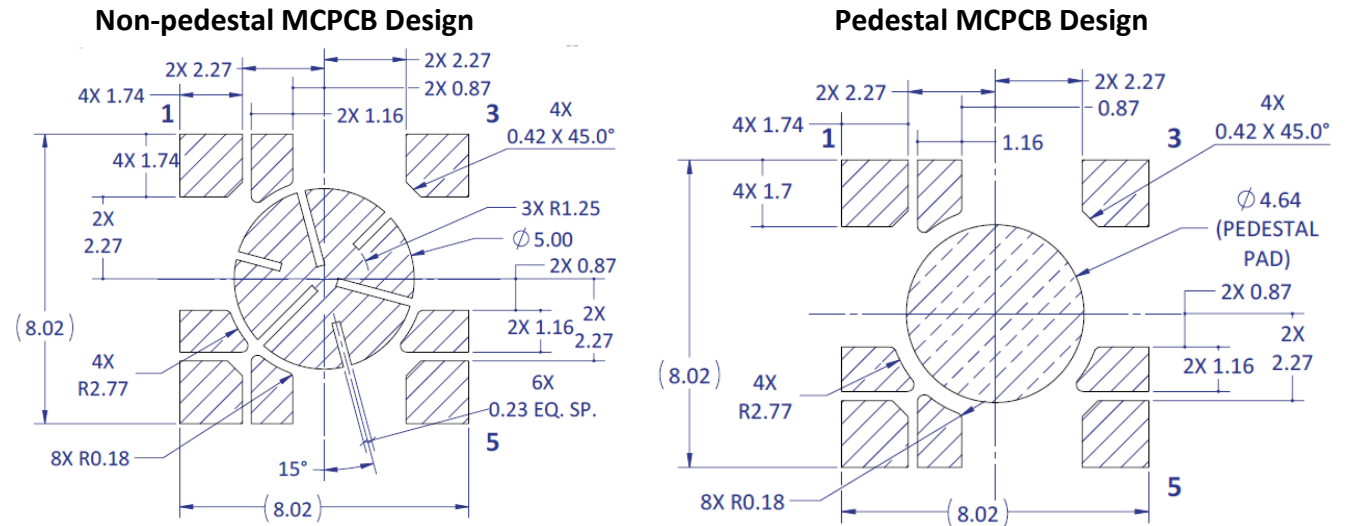

Figure 2a: Recommended solder pad layout for anode, cathode, and thermal pad for non-pedestal and pedestal design

Note for Figure 2a:

1. Unless otherwise noted, the tolerance =  $\pm 0.20$  mm.
2. Pedestal MCPCB allows the emitter thermal slug to be soldered directly to the metal core of the MCPCB. Such MCPCB eliminate the high thermal resistance dielectric layer that standard MCPCB technologies use in between the emitter thermal slug and the metal core of the MCPCB, thus lowering the overall system thermal resistance.
3. LED Engin recommends x-ray sample monitoring for solder voids underneath the emitter thermal slug. The total area covered by solder voids should be less than 20% of the total emitter thermal slug area. Excessive solder voids will increase the emitter to MCPCB thermal resistance and may lead to higher failure rates due to thermal over stress.

## Recommended Solder Mask Layout (mm)



Figure 2b: Recommended solder mask opening for anode, cathode, and thermal pad for non-pedestal and pedestal design

Note for Figure 2b:

1. Unless otherwise noted, the tolerance =  $\pm 0.20$  mm.

## Recommended 8 mil Stencil Apertures Layout (mm)

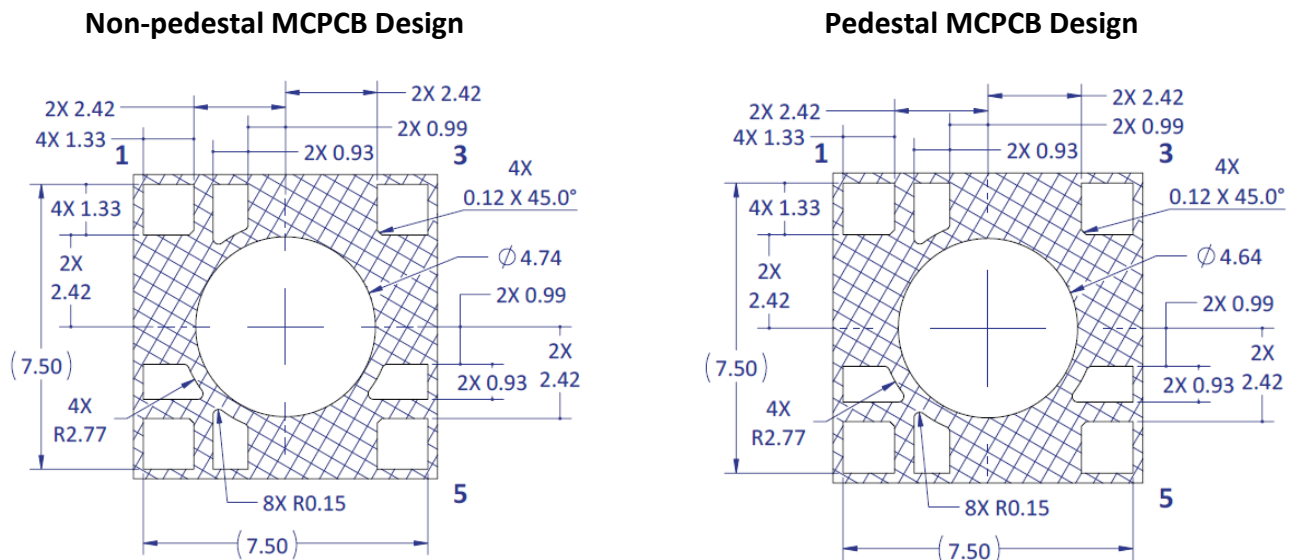

Figure 2c: Recommended 8mil stencil apertures for anode, cathode, and thermal pad for non-pedestal and pedestal design

Note for Figure 2c:

1. Unless otherwise noted, the tolerance =  $\pm 0.20$  mm.



## Reflow Soldering Profile



Figure 3: Reflow soldering profile for lead free soldering

## Typical Radiation Pattern

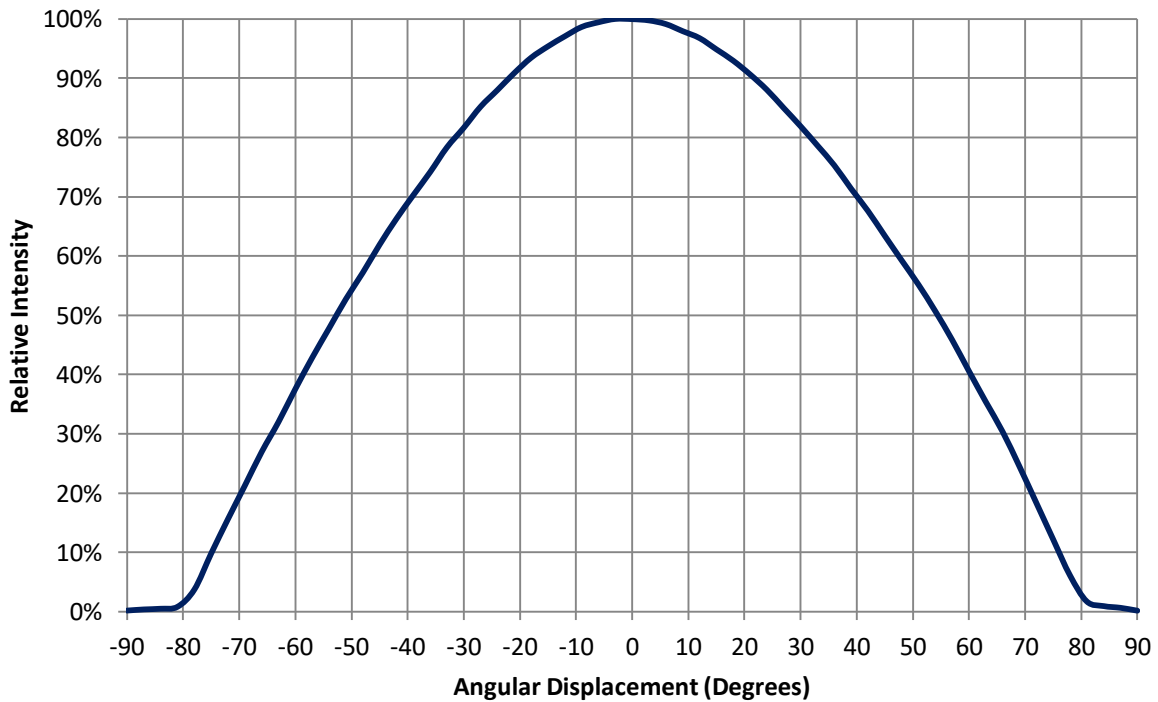

Figure 4: Typical representative spatial radiation pattern

### Typical Relative Spectral Power Distribution

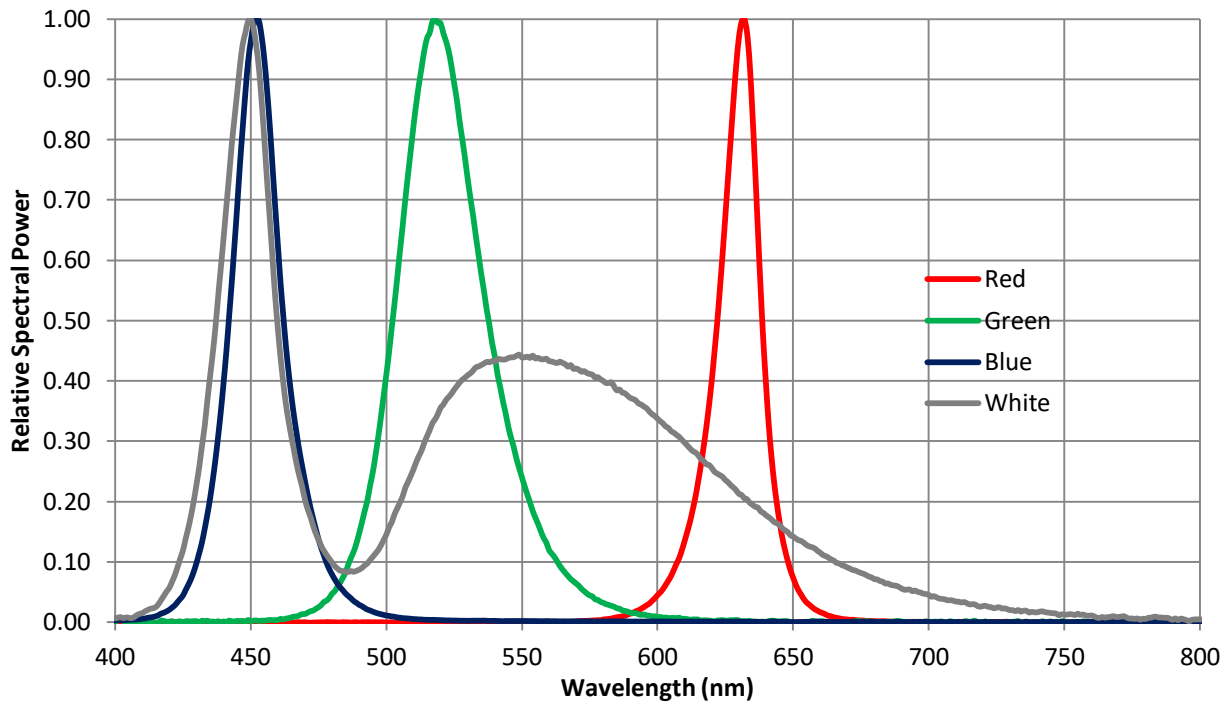

Figure 5: Typical relative spectral power vs. wavelength @ T<sub>c</sub> = 25°C.

### Typical Forward Current Characteristics



Figure 6: Typical forward current vs. forward voltage @ T<sub>c</sub> = 25°C

### Typical Relative Light Output over Current

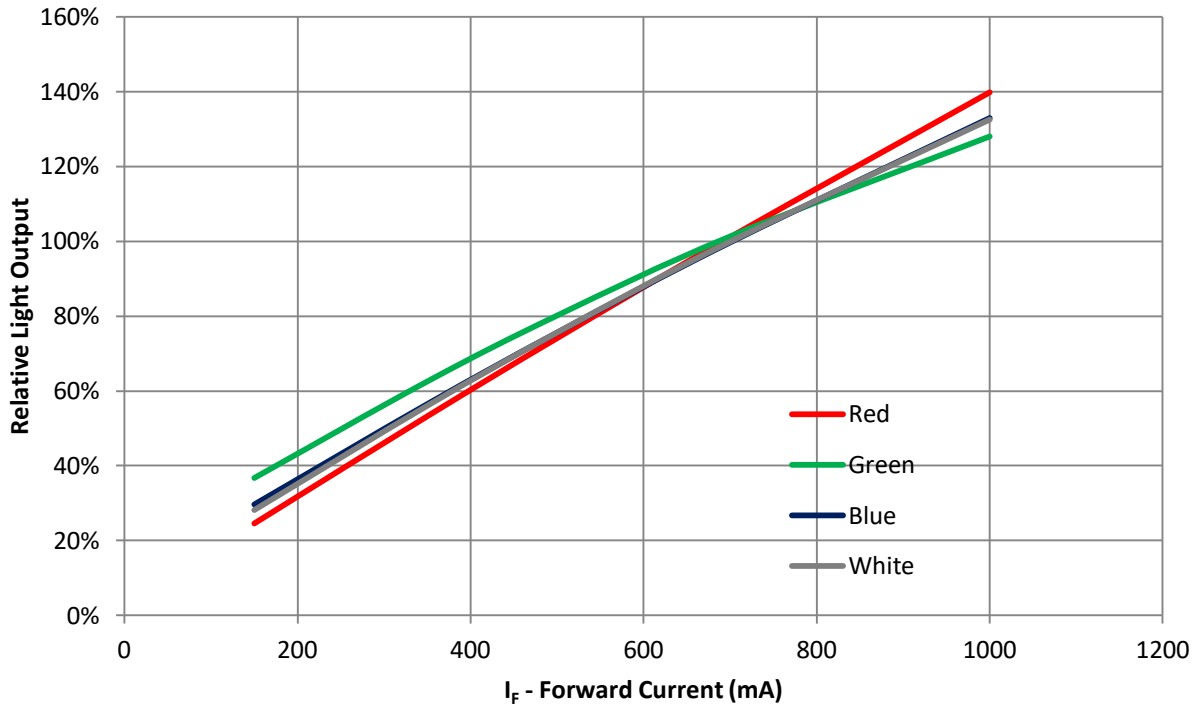

Figure 7: Typical relative light output vs. forward current @ T<sub>c</sub> = 25°C

### Typical Relative Light Output over Temperature

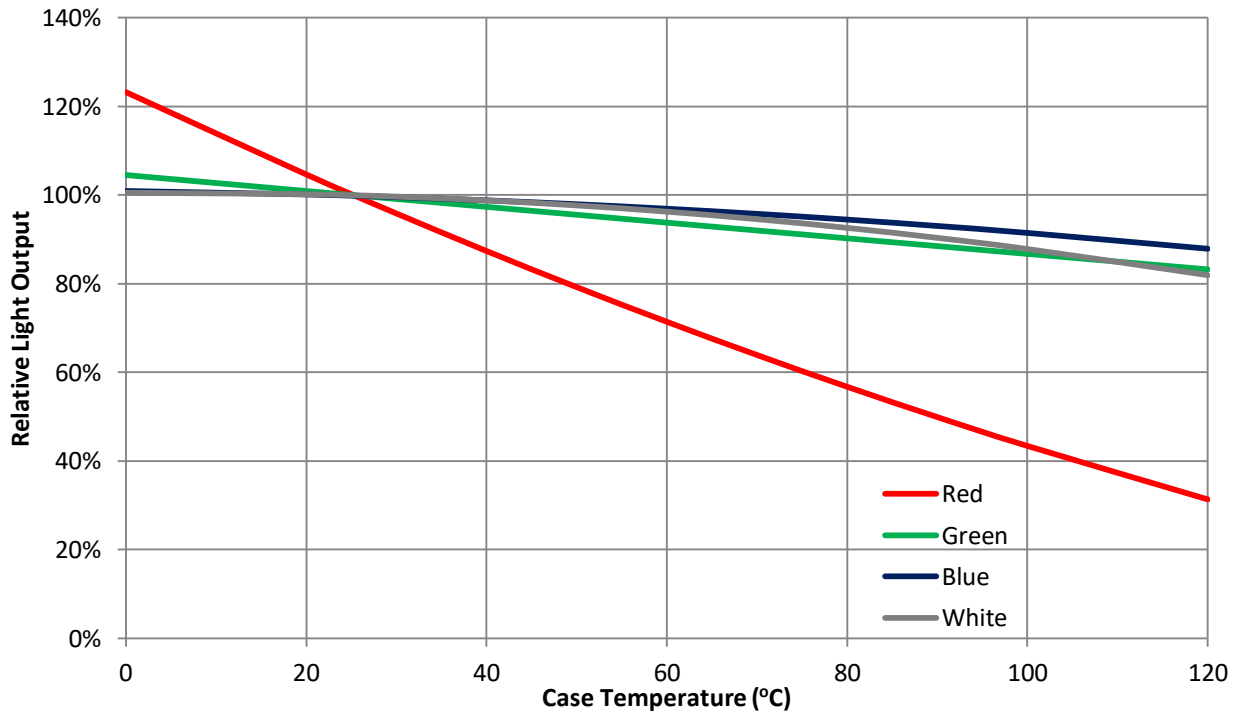

Figure 8: Typical relative light output vs. case temperature.

### Typical Dominant Wavelength/Chromaticity Coordinate Shift over Current

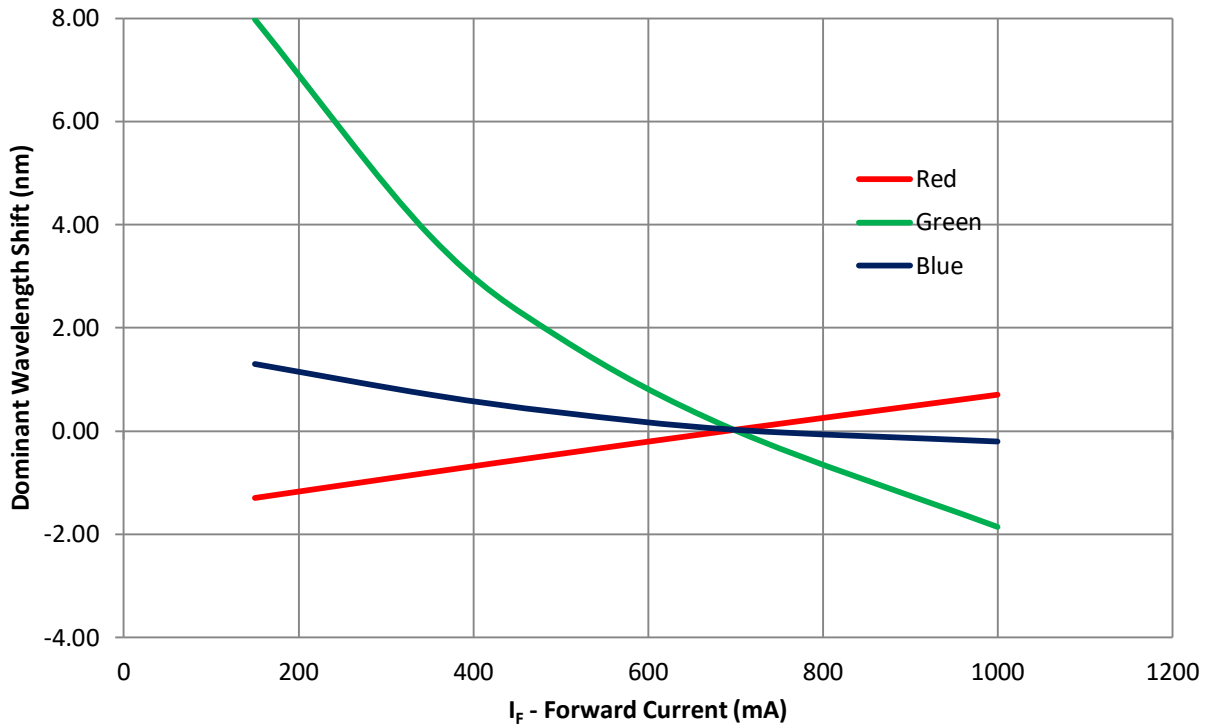

Figure 9a: Typical dominant wavelength shift vs. forward current @  $T_c = 25^\circ\text{C}$ .

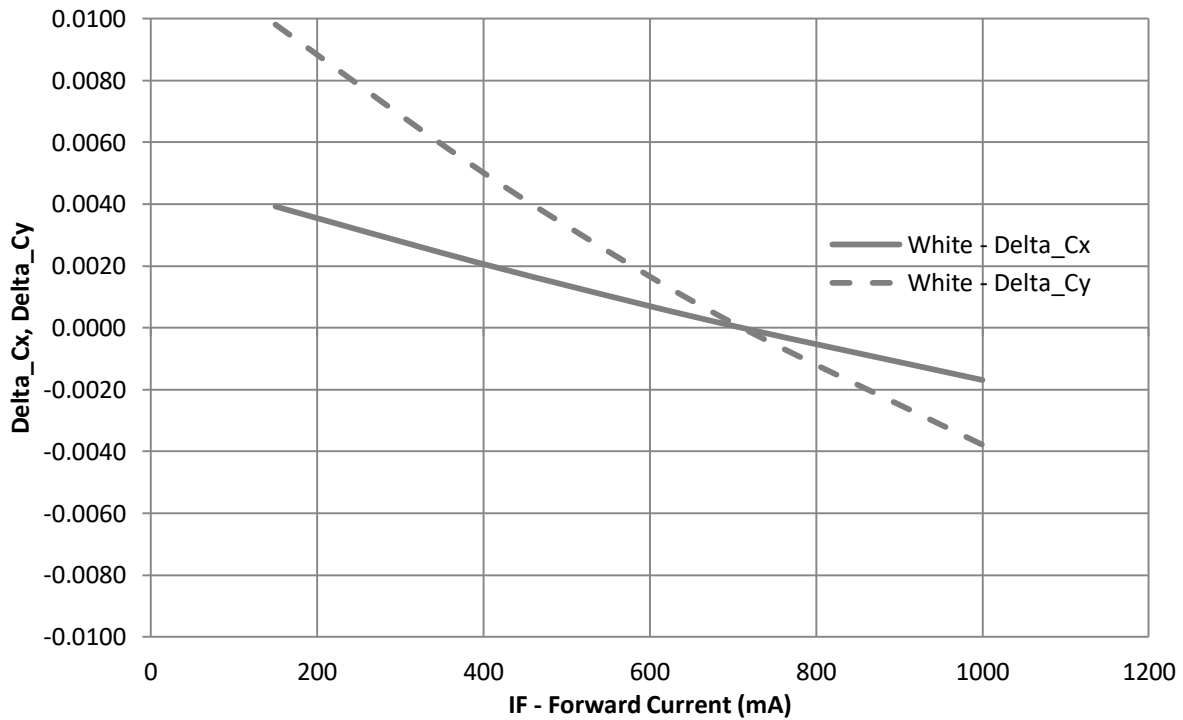

Figure 9b: Typical chromaticity coordinate shift vs. forward current @  $T_c = 25^\circ\text{C}$ .

### Typical Dominant Wavelength/Chromaticity Coordinate Shift over Temperature

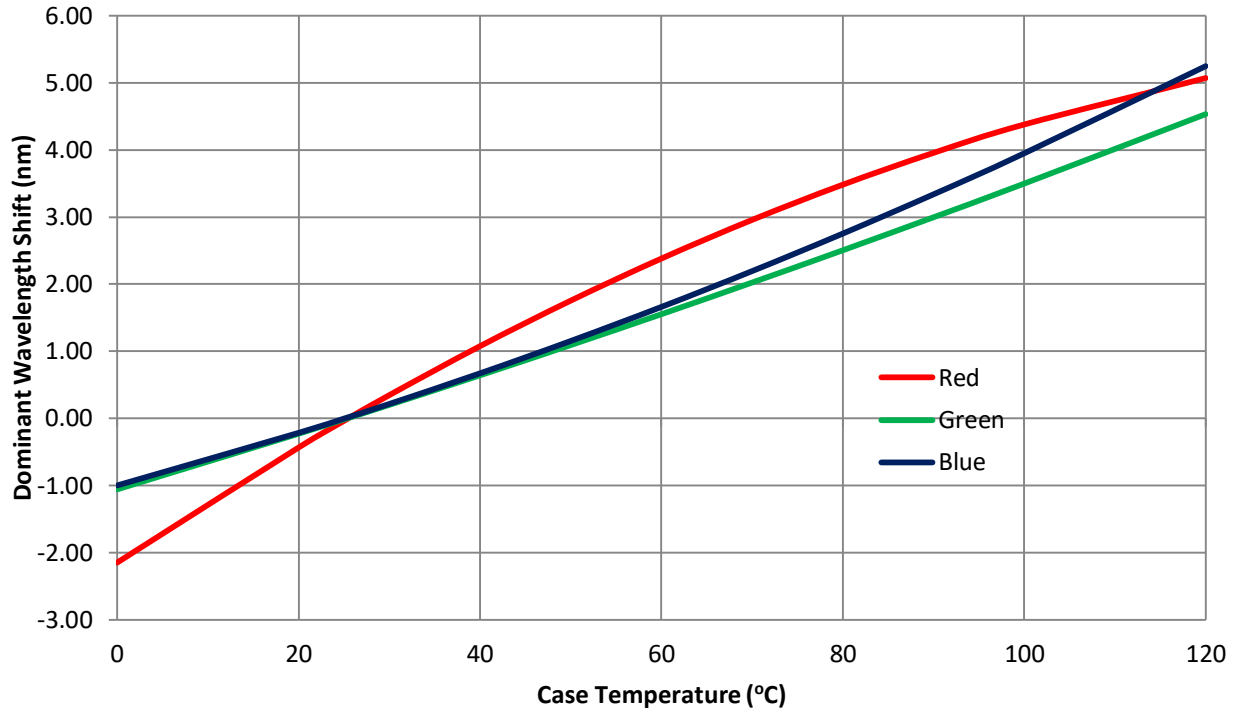

Figure 10a: Typical dominant wavelength shift vs. case temperature



Figure 10b: Typical chromaticity coordinate shift vs. case temperature

## Current De-rating

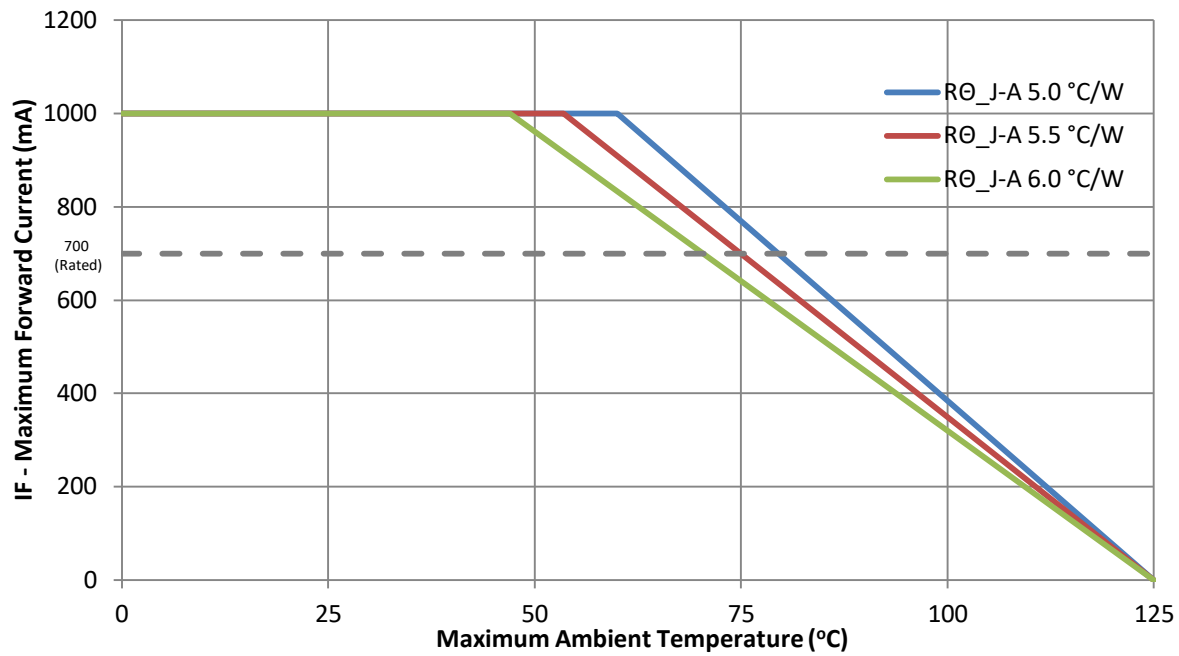

Figure 11: Maximum forward current vs. ambient temperature based on  $T_{J(MAX)} = 125^{\circ}\text{C}$

Notes for Figure 11:

1. Maximum current assumes that all four LED dice are operating concurrently at the same current.
2.  $R_{\theta_{J-C}}$  [Junction to Case Thermal Resistance] for LZ4-04MDC9 is typically  $2.8^{\circ}\text{C/W}$ .
3.  $R_{\theta_{J-A}}$  [Junction to Ambient Thermal Resistance] =  $R_{\theta_{J-C}} + R_{\theta_{C-A}}$  [Case to Ambient Thermal Resistance].

## Emitter Tape and Reel Specifications (mm)

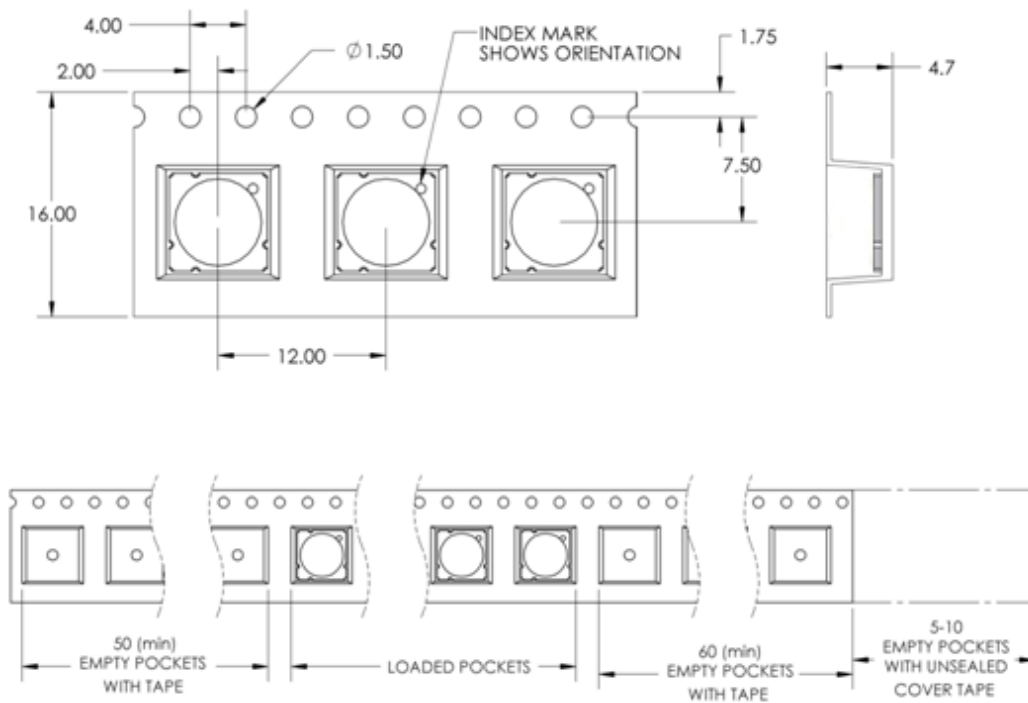

Figure 12: Emitter carrier tape specifications (mm).

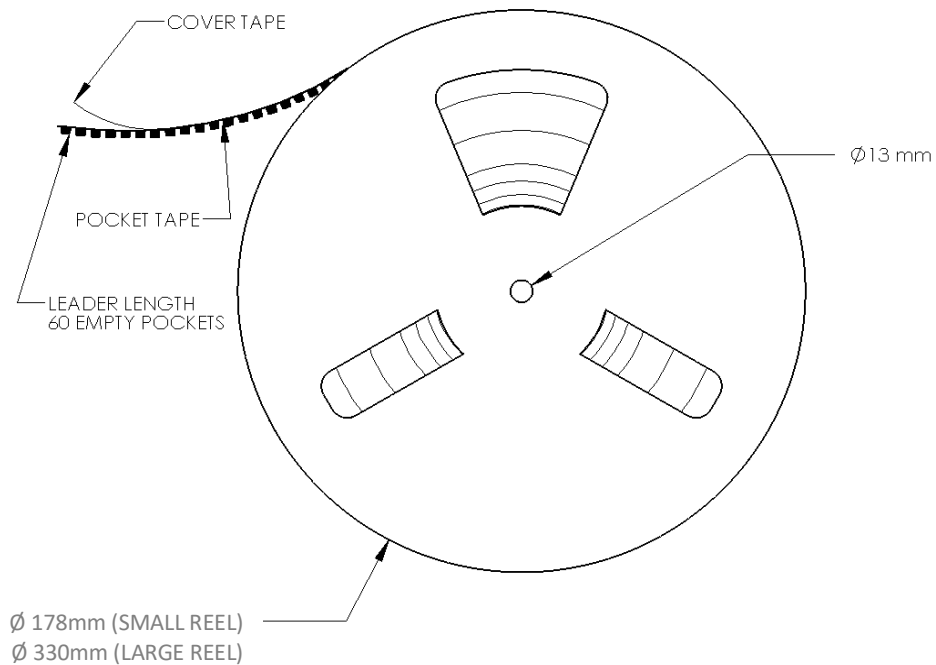

Figure 13: Emitter reel specifications (mm).

Notes for Figure 13:

1. Small reel quantity: up to 250 emitters
2. Large reel quantity: 250-2000 emitters.
3. Single flux bin and single wavelength per reel.

# LZ4 MCPCB Family

Part number	Type of MCPCB	Diameter (mm)	Emitter + MCPCB Thermal Resistance (°C/W)	Typical $V_f$ (V)	Typical $I_f$ (mA)
LZ4-6xxxxxx	4-channel	19.9	$2.8 + 0.2 = 3.0$	2.5 – 3.6	700

## Mechanical Mounting of MCPCB

- MCPCB bending should be avoided as it will cause mechanical stress on the emitter, which could lead to substrate cracking and subsequently LED dies cracking.
- To avoid MCPCB bending:
  - Special attention needs to be paid to the flatness of the heat sink surface and the torque on the screws.
  - Care must be taken when securing the board to the heat sink. This can be done by tightening three M3 screws (or #4-40) in steps and not all the way through at once. Using fewer than three screws will increase the likelihood of board bending.
  - It is recommended to always use plastics washers in combinations with the three screws.
  - If non-taped holes are used with self-tapping screws, it is advised to back out the screws slightly after tightening (with controlled torque) and then re-tighten the screws again.

## Thermal interface material

- To properly transfer heat from LED emitter to heat sink, a thermally conductive material is required when mounting the MCPCB on to the heat sink.
- There are several varieties of such material: thermal paste, thermal pads, phase change materials and thermal epoxies. An example of such material is Electrolube EHTC.
- It is critical to verify the material's thermal resistance to be sufficient for the selected emitter and its operating conditions.

## Wire soldering

- To ease soldering wire to MCPCB process, it is advised to preheat the MCPCB on a hot plate of 125-150°C. Subsequently, apply the solder and additional heat from the solder iron will initiate a good solder reflow. It is recommended to use a solder iron of more than 60W.
- It is advised to use lead-free, no-clean solder. For example: SN-96.5 AG-3.0 CU 0.5 #58/275 from Kester (pn: 24-7068-7601)



# LZ4-6xxxxx

## 4 channel, Standard Star MCPCB (4x1) Dimensions (mm)

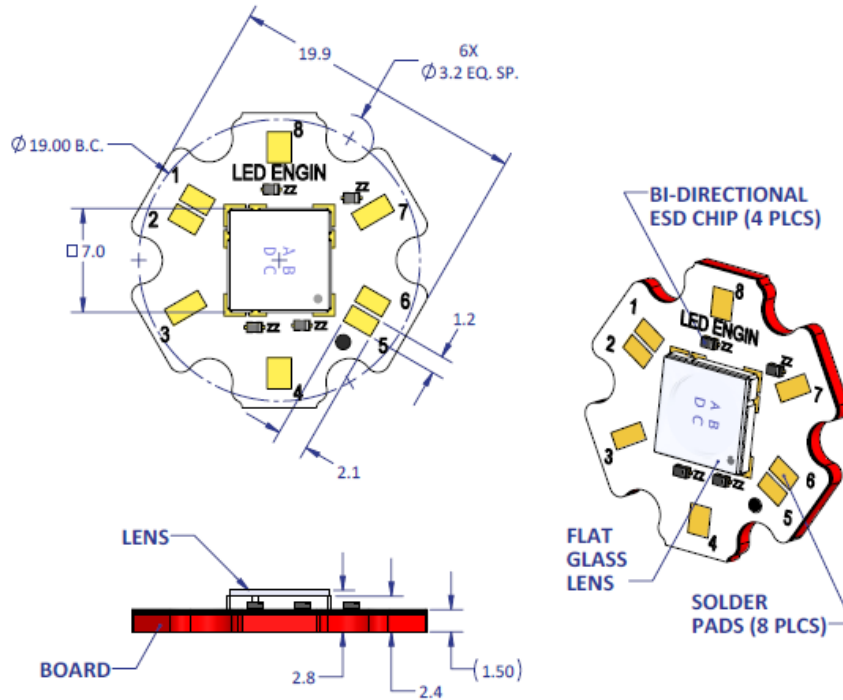

**Notes:**

- Unless otherwise noted, the tolerance =  $\pm 0.2$  mm.
- Slots in MCPCB are for M3 or #4-40 mounting screws.
- LED Engin recommends plastic washers to electrically insulate screws from solder pads and electrical traces.
- LED Engin recommends using thermal interface material when attaching the MCPCB to a heatsink.
- The thermal resistance of the MCPCB is:  $\theta_{JC-B}$  0.2°C/W

## Components used

MCPCB: MHE-301 copper (Rayben)  
ESD chips: BZT52C5-C10 (NXP, for 1 LED die)

Pad layout			
Ch.	MCPCB Pad	String/die	Function
1	8	1/A	Anode +
	1		Cathode -
2	6	2/B	Anode +
	3		Cathode -
3	5	3/C	Anode +
	4		Cathode -
4	7	4/D	Anode +
	2		Cathode -

## About LED Engin

LED Engin, an OSRAM business based in California's Silicon Valley, develops, manufactures, and sells advanced LED emitters, optics and light engines to create uncompromised lighting experiences for a wide range of entertainment, architectural, general lighting and specialty applications. LuxiGen™ multi-die emitter and secondary lens combinations reliably deliver industry-leading flux density, upwards of 5000 quality lumens to a target, in a wide spectrum of colors including whites, tunable whites, multi-color and UV LEDs in a unique patented compact ceramic package. Our LuxiTune™ series of tunable white lighting modules leverage our LuxiGen emitters and lenses to deliver quality, control, freedom and high density tunable white light solutions for a broad range of new recessed and downlighting applications. The small size, yet remarkably powerful beam output and superior in-source color mixing, allows for a previously unobtainable freedom of design wherever high-flux density, directional light is required. LED Engin is committed to providing products that conserve natural resources and reduce greenhouse emissions; and reserves the right to make changes to improve performance without notice.

For more information, please contact [LEDE-Sales@osram.com](mailto:LEDE-Sales@osram.com) or +1 408 922-7200.

Компания «Life Electronics» занимается поставками электронных компонентов импортного и отечественного производства от производителей и со складов крупных дистрибьюторов Европы, Америки и Азии.

С конца 2013 года компания активно расширяет линейку поставок компонентов по направлению коаксиальный кабель, кварцевые генераторы и конденсаторы (керамические, пленочные, электролитические), за счёт заключения дистрибьюторских договоров

Мы предлагаем:

- Конкурентоспособные цены и скидки постоянным клиентам.
- Специальные условия для постоянных клиентов.
- Подбор аналогов.
- Поставку компонентов в любых объемах, удовлетворяющих вашим потребностям.
- Приемлемые сроки поставки, возможна ускоренная поставка.
- Доставку товара в любую точку России и стран СНГ.
- Комплексную поставку.
- Работу по проектам и поставку образцов.
- Формирование склада под заказчика.
- Сертификаты соответствия на поставляемую продукцию (по желанию клиента).
- Тестирование поставляемой продукции.
- Поставку компонентов, требующих военную и космическую приемку.
- Входной контроль качества.
- Наличие сертификата ISO.

В составе нашей компании организован Конструкторский отдел, призванный помогать разработчикам, и инженерам.

Конструкторский отдел помогает осуществить:

- Регистрацию проекта у производителя компонентов.
- Техническую поддержку проекта.
- Защиту от снятия компонента с производства.
- Оценку стоимости проекта по компонентам.
- Изготовление тестовой платы монтаж и пусконаладочные работы.



Тел: +7 (812) 336 43 04 (многоканальный)

Email: [org@lifeelectronics.ru](mailto:org@lifeelectronics.ru)