

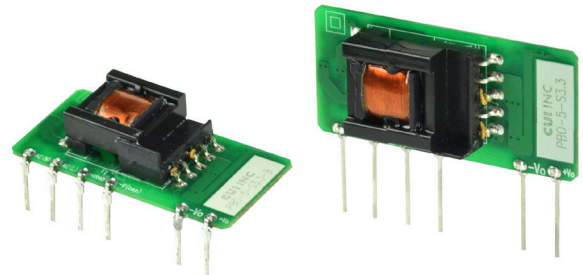

SERIES: PBO-5 | **DESCRIPTION:** AC-DC POWER SUPPLY

FEATURES

- up to 5 W continuous power
- ultra-compact SIP package
- wide input voltage range
- over current and short circuit protections
- 4,000 Vac isolation
- UL 62368, CE safety approvals
- efficiency up to 79%



MODEL	output voltage (Vdc)	output current		output power max (W)	ripple and noise ¹ max (mVp-p)	efficiency ² typ (%)
		min (mA)	max (mA)			
PBO-5-S3.3	3.3	0	1000	3.3	150	67
PBO-5-S5	5	0	1000	5	150	74
PBO-5-S9	9	0	560	5	150	75
PBO-5-S12	12	0	420	5	150	76
PBO-5-S15	15	0	340	5	150	77
PBO-5-S24	24	0	210	5	150	79

Notes: 1. At full load, nominal input, 20 MHz bandwidth oscilloscope, with a 1 µF ceramic and 10 µF electrolytic capacitor on the output.
 2. At 230 Vac input.
 3. All specifications are measured at Ta=25°C, humidity <75%, 115 or 230 Vac input voltage, and rated output load unless otherwise specified.

PART NUMBER KEY

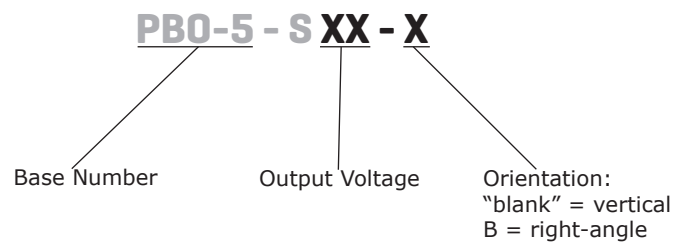

INPUT

parameter	conditions/description	min	typ	max	units
voltage		85		264	Vac
		100		400	Vdc
frequency		47		63	Hz
current	at 115 Vac			0.2	A
	at 230 Vac			0.1	A
inrush current	at 115 Vac		5		A
	at 230 Vac		10		A
leakage current	CY0 is 1 nF/400 Vac			0.25	mA
no load power consumption				0.5	W

OUTPUT

parameter	conditions/description	min	typ	max	units
capacitive load	3.3 Vdc output models			2,200	μF
	5 Vdc output models			1,500	μF
	9 Vdc output models			680	μF
	12 Vdc output models			470	μF
	15 Vdc output models			330	μF
	24 Vdc output models			100	μF
initial set point accuracy	3.3 Vdc output models			±3	%
	all other models			±2	%
line regulation	at full load		±0.5		%
load regulation	from 10~100% load			±1.5	%
hold-up time	at 115 Vac		15		ms
	at 230 Vac		75		ms
switching frequency			100		kHz
temperature coefficient			±0.02		%/°C

PROTECTIONS

parameter	conditions/description	min	typ	max	units
over voltage protection	output voltage clamp				
	3.3 & 5 Vdc output models			7.5	Vdc
	9 Vdc output models			15	Vdc
	12 & 15 Vdc output models			20	Vdc
	24 Vdc output models			30	Vdc
over current protection	auto recovery	150			%
short circuit protection	continuous, auto recovery				

SAFETY & COMPLIANCE

parameter	conditions/description	min	typ	max	units
isolation voltage	input to output at 5 mA for 1 minute	4,000			Vac
safety approvals	UL 62368, EN 62368				
safety class	class II				
conducted emissions	CISPR32/EN55032 Class A, (external circuit required, see figure 1)				
	CISPR32/EN55032 Class B, (external circuit required, see figure 2)				
radiated emissions	CISPR32/EN55032 Class B, (external circuit required, see figure 1)				
ESD	IEC/EN61000-4-2 Class B, ±6 kV				
radiated immunity	IEC/EN61000-4-3 Class A, 10V/m				
EFT/burst	IEC/EN61000-4-4 Class B, ±2 kV (external circuit required, see figure 1)				
	IEC/EN61000-4-4 Class B, ±4 kV (external circuit required, see figure 2)				

Notes: 1. The power supply is considered a component which will be installed into final equipment. The final equipment still must be tested to meet the necessary EMC directives.

SAFETY & COMPLIANCE (CONTINUED)

parameter	conditions/description	min	typ	max	units
surge	IEC/EN61000-4-5 Class B, ±1 kV (external circuit required, see figure 1)				
	IEC/EN61000-4-5 Class B, ±1 kV/±2 kV				
conducted immunity	IEC/EN61000-4-6 Class A, 10 Vr.m.s (external circuit required, see figure 2)				
voltage dips & interruptions	IEC/EN61000-4-11 Class B, 0%-70%				
MTBF	as per MIL-HDBK-217F at 25 °C	300,000			hours
RoHS	2011/65/EU				

Notes: 1. The power supply is considered a component which will be installed into final equipment. The final equipment still must be tested to meet the necessary EMC directives.

ENVIRONMENTAL

parameter	conditions/description	min	typ	max	units
operating temperature	see derating curves	-25		85	°C
storage temperature		-40		105	°C
storage humidity	non-condensing			85	%

SOLDERABILITY

parameter	conditions/description	min	typ	max	units
hand soldering	for 3~5 seconds	350	360	370	°C
wave soldering	for 5~10 seconds	255	260	265	°C

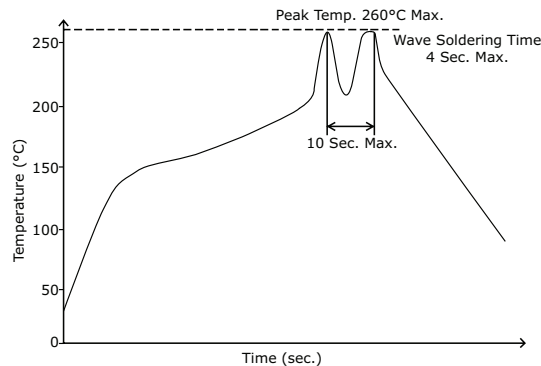

DERATING CURVES

load vs. ambient temperature
(at 85~264 Vac / 100~400 Vdc input voltage)

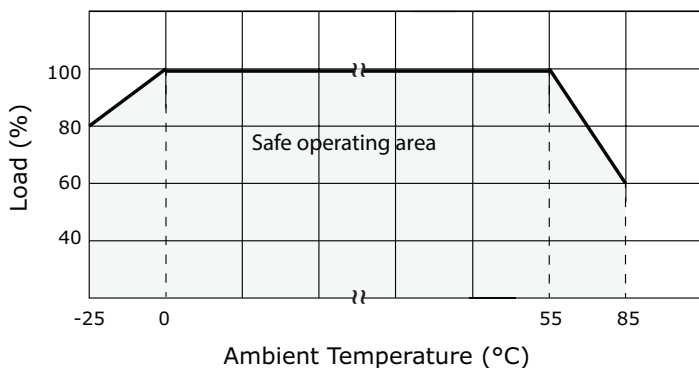

load vs. input voltage
(at 25°C)

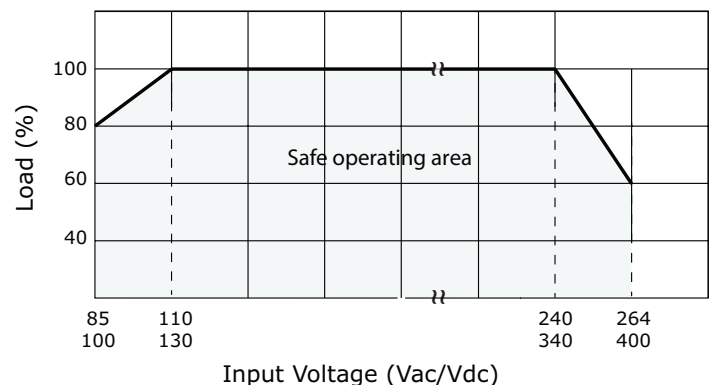

EFFICIENCY CURVES

PBO-5-S3.3 AC Input Efficiency Curve
(Efficiency vs. Load Current)

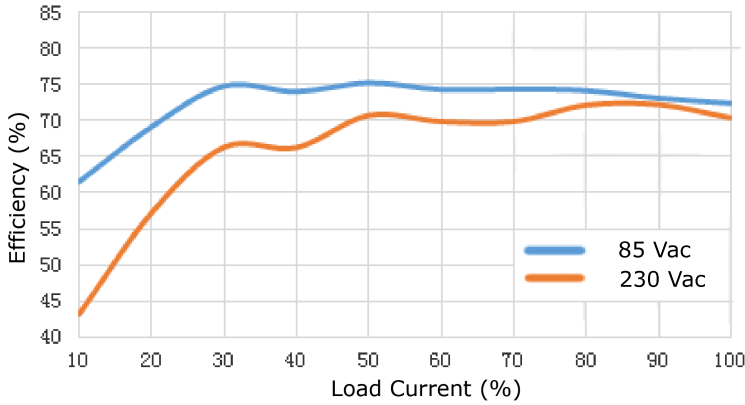

PBO-5-S3.3 DC Input Efficiency Curve
(Efficiency vs. Load Current)

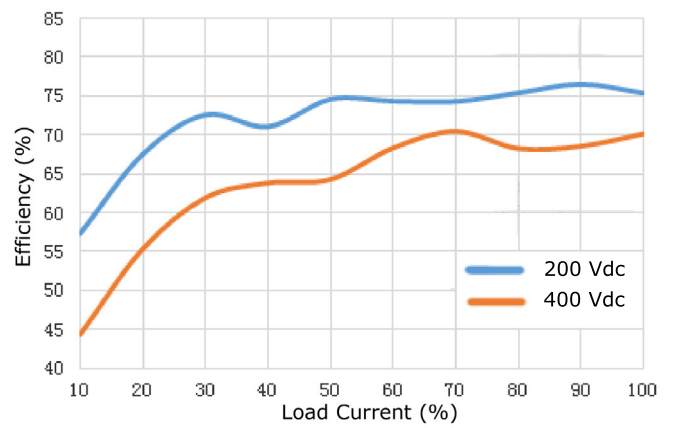

PBO-5-S5 AC Input Efficiency Curve
(Efficiency vs. Load Current)

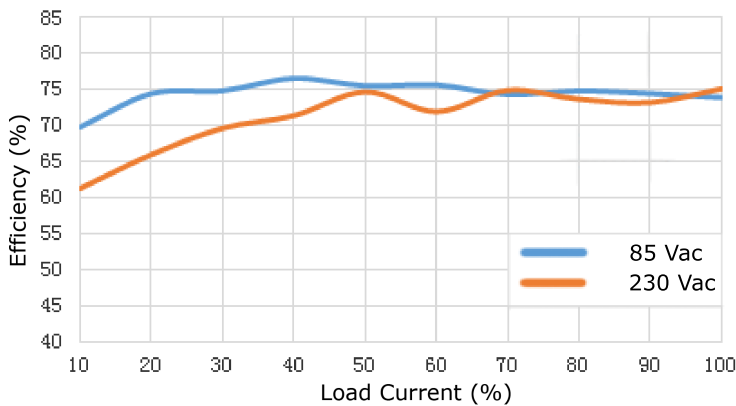

PBO-5-S5 DC Input Efficiency Curve
(Efficiency vs. Load Current)

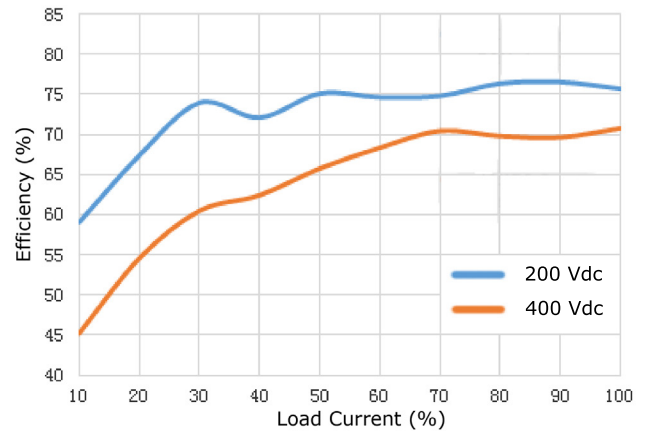

PBO-5-S9 AC Input Efficiency Curve
(Efficiency vs. Load Current)

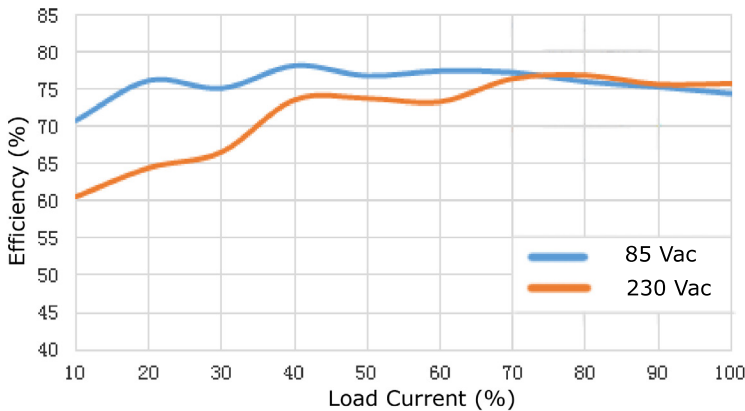

PBO-5-S9 DC Input Efficiency Curve
(Efficiency vs. Load Current)

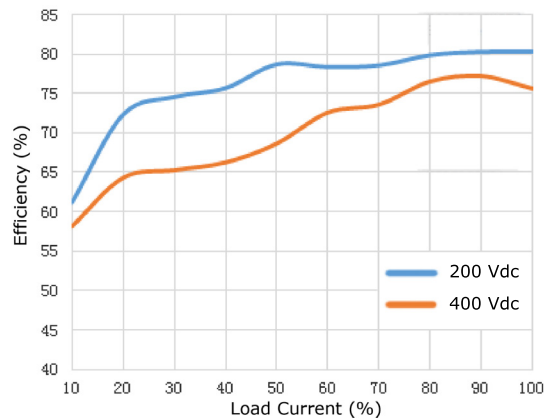

EFFICIENCY CURVES (CONTINUED)

PBO-5-S12 AC Input Efficiency Curve
(Efficiency vs. Load Current)

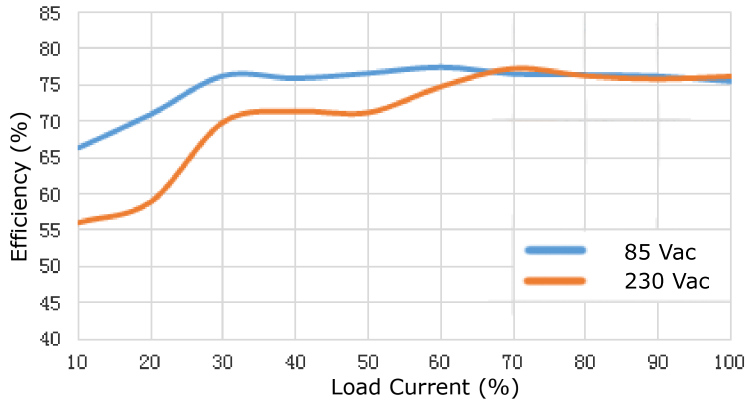

PBO-5-S12 DC Input Efficiency Curve
(Efficiency vs. Load Current)



PBO-5-S15 AC Input Efficiency Curve
(Efficiency vs. Load Current)

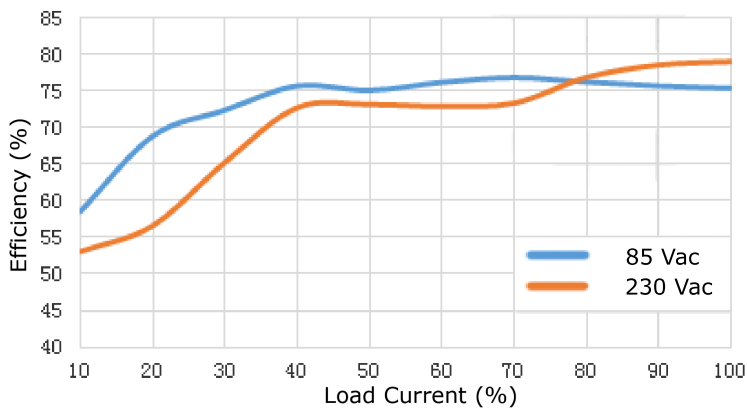

PBO-5-S15 DC Input Efficiency Curve
(Efficiency vs. Load Current)

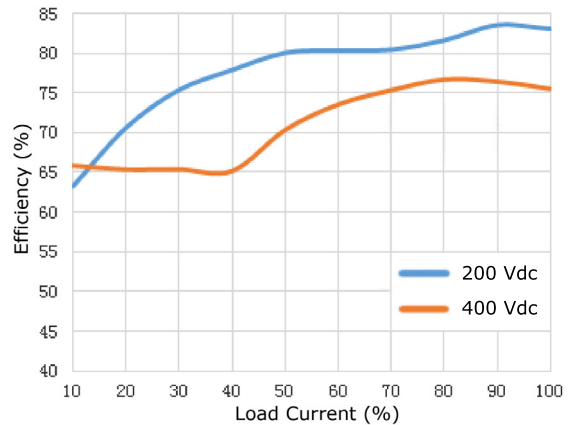

PBO-5-S24 AC Input Efficiency Curve
(Efficiency vs. Load Current)

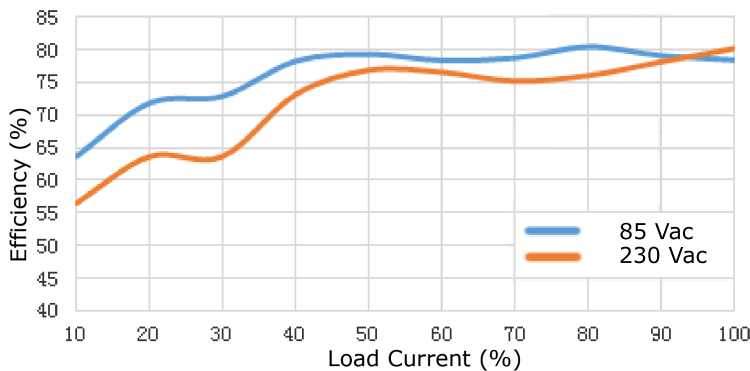

PBO-5-S24 DC Input Efficiency Curve
(Efficiency vs. Load Current)



MECHANICAL

parameter	conditions/description	min	typ	max	units
dimensions	vertical models: 40.00 x 12.80 x 18.50 (1.575 x 0.504 x 0.729 inches) right-angle models: 40.00 x 20.00 x 12.80 (1.575 x 0.787 x 0.504 inches)				mm mm
weight			7		g

MECHANICAL DRAWING

Vertical Orientation

units: mm[inch]

tolerance: $\pm 0.50[\pm 0.020]$

pin section tolerance: $\pm 0.10[\pm 0.004]$

PIN CONNECTIONS	
PIN	Function
1	AC (N)
3	AC (L)
5	+V(CAP)
7	-V(CAP)
12	-Vo
14	+Vo

Note: 1. It is required to add C1 between pins 5 & 7 (see application circuits).

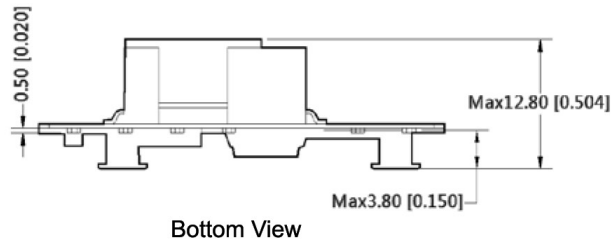
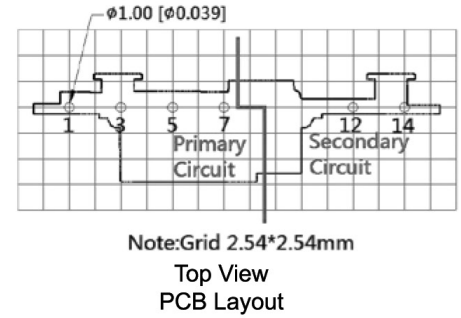
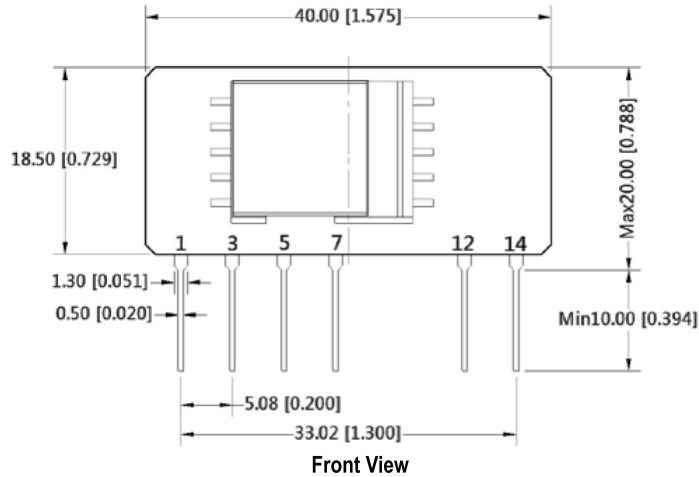

MECHANICAL DRAWING (CONTINUED)

Right-angle Orientation

units: mm[inch]

tolerance: $\pm 0.50[\pm 0.020]$

pin section tolerance: $\pm 0.10[\pm 0.004]$

PIN CONNECTIONS	
PIN	Function
1	AC (N)
3	AC (L)
5	+V(CAP)
7	-V(CAP)
12	-Vo
14	+Vo

Note: 1. It is required to add C1 between pins 5 & 7 (see application circuits).

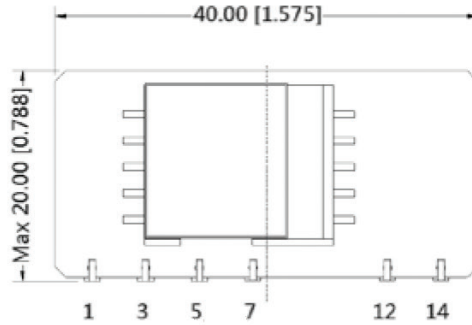

Top View

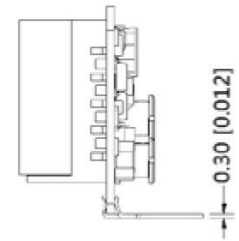

Right View



Front View



Top View
PCB Layout

APPLICATION CIRCUIT

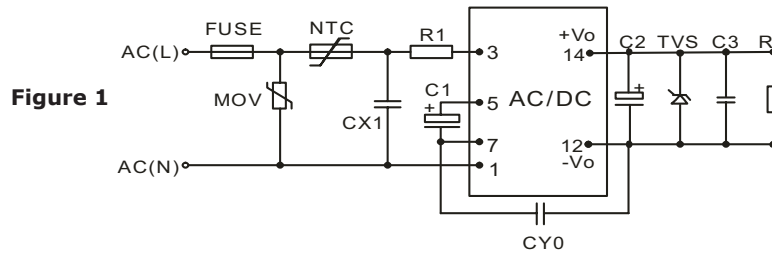

Table 1

Recommended External Circuit Components										
Vo (Vdc)	FUSE ¹	MOV	NTC	CX1	R1	C1 ¹	CY0	C2 ¹	TVS	C3
3.3	1A/250V	S14K350	13D-5	0.1μF/275Vac	12Ω/2W	10μF/400V	1nF/400Vac	220μF/35V	SMBJ7.0A	100nF/50V
5	1A/250V	S14K350	13D-5	0.1μF/275Vac	12Ω/2W	10μF/400V	1nF/400Vac	220μF/35V	SMBJ7.0A	100nF/50V
9	1A/250V	S14K350	13D-5	0.1μF/275Vac	12Ω/2W	10μF/400V	1nF/400Vac	220μF/35V	SMBJ12A	100nF/50V
12	1A/250V	S14K350	13D-5	0.1μF/275Vac	12Ω/2W	10μF/400V	1nF/400Vac	150μF/35V	SMBJ20A	100nF/50V
15	1A/250V	S14K350	13D-5	0.1μF/275Vac	12Ω/2W	10μF/400V	1nF/400Vac	150μF/35V	SMBJ20A	100nF/50V
24	1A/250V	S14K350	13D-5	0.1μF/275Vac	12Ω/2W	10μF/400V	1nF/400Vac	100μF/35V	SMBJ30A	100nF/50V

Note: 1. Required components.

EMC RECOMMENDED CIRCUIT

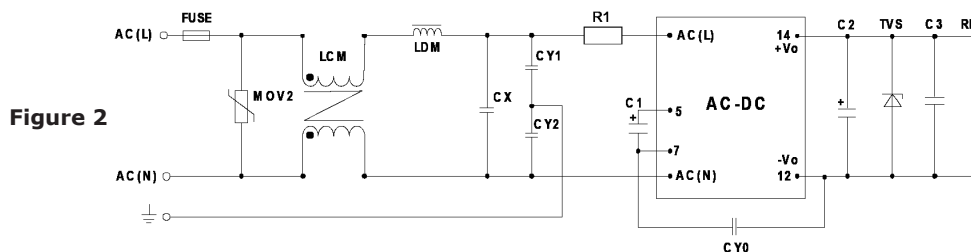

Table 2

Recommended External Circuit Components	
FUSE	1A/250V, slow fusing
MOV2	S14K320
LCM	3.5mH
LDM	330μH
CX	0.1μF/275 Vac
CY1, CY2	1nF/400 Vac
R1	12Ω/2W
C1	10μF/400V
CY0	1nF/400Vac

Note: Also refer to Table 1.

- Notes:
- C1 is required for both AC and DC inputs. For input voltages greater than 370 Vdc, the recommended value is 10 μF / 450 V.
 - C2 is recommended to be a high frequency and low impedance capacitor. For capacitance and rated ripple current of capacitors, refer to the datasheets provided by the manufacturers. Voltage derating of capacitors should be 80% or above.
 - C3 is a ceramic capacitor used to filter high frequency noise.
 - TVS is a recommended post-component to protect post-circuits (if converter fails).
 - It is required to have a distance ≥ 6.4 mm for safety between external components in primary and secondary circuit.

REVISION HISTORY

rev.	description	date
1.0	initial release	10/18/2016
1.01	added right-angle pin versions, updated to 62368 safety approvals, reduced component height to 12.80 mm max	04/19/2018

The revision history provided is for informational purposes only and is believed to be accurate.



Headquarters
20050 SW 112th Ave.
Tualatin, OR 97062
800.275.4899

Fax 503.612.2383
cui.com
techsupport@cui.com

CUI offers a two (2) year limited warranty. Complete warranty information is listed on our website.

CUI reserves the right to make changes to the product at any time without notice. Information provided by CUI is believed to be accurate and reliable. However, no responsibility is assumed by CUI for its use, nor for any infringements of patents or other rights of third parties which may result from its use.

CUI products are not authorized or warranted for use as critical components in equipment that requires an extremely high level of reliability. A critical component is any component of a life support device or system whose failure to perform can be reasonably expected to cause the failure of the life support device or system, or to affect its safety or effectiveness.

Компания «Life Electronics» занимается поставками электронных компонентов импортного и отечественного производства от производителей и со складов крупных дистрибьюторов Европы, Америки и Азии.

С конца 2013 года компания активно расширяет линейку поставок компонентов по направлению коаксиальный кабель, кварцевые генераторы и конденсаторы (керамические, пленочные, электролитические), за счёт заключения дистрибьюторских договоров

Мы предлагаем:

- Конкурентоспособные цены и скидки постоянным клиентам.
- Специальные условия для постоянных клиентов.
- Подбор аналогов.
- Поставку компонентов в любых объемах, удовлетворяющих вашим потребностям.
- Приемлемые сроки поставки, возможна ускоренная поставка.
- Доставку товара в любую точку России и стран СНГ.
- Комплексную поставку.
- Работу по проектам и поставку образцов.
- Формирование склада под заказчика.
- Сертификаты соответствия на поставляемую продукцию (по желанию клиента).
- Тестирование поставляемой продукции.
- Поставку компонентов, требующих военную и космическую приемку.
- Входной контроль качества.
- Наличие сертификата ISO.

В составе нашей компании организован Конструкторский отдел, призванный помогать разработчикам, и инженерам.

Конструкторский отдел помогает осуществить:

- Регистрацию проекта у производителя компонентов.
- Техническую поддержку проекта.
- Защиту от снятия компонента с производства.
- Оценку стоимости проекта по компонентам.
- Изготовление тестовой платы монтаж и пусконаладочные работы.



Тел: +7 (812) 336 43 04 (многоканальный)

Email: org@lifeelectronics.ru