

# MAX7033

# 315MHz/433MHz ASK Superheterodyne Receiver with AGC Lock

## General Description

The MAX7033 fully integrated low-power CMOS super-heterodyne receiver is ideal for receiving amplitude shift-keyed (ASK) data in the 300MHz to 450MHz frequency range. The receiver has an RF input signal range of -114dBm to 0dBm. With few external components and a low-current power-down mode, it is ideal for cost-sensitive and power-sensitive applications typical in consumer markets. The MAX7033 consists of a low-noise amplifier (LNA), a fully differential image-rejection mixer, an on-chip phase-locked loop (PLL) with integrated voltage-controlled oscillator (VCO), a 10.7MHz IF limiting amplifier stage with received-signal-strength indicator (RSSI), and analog baseband data-recovery circuitry. The MAX7033 also has a discrete one-step automatic gain control (AGC) that reduces the LNA gain by 35dB when the RF input signal exceeds -62dBm. The AGC circuitry offers an externally controlled hold feature.

The MAX7033 is available in 28-pin TSSOP and 32-pin TQFN packages and is specified over the extended (-40°C to +105°C) temperature range.

## Applications

- Security Systems
- Remote Controls
- Garage Door Openers
- Local Telemetry
- Home Automation
- Wireless Sensors

## Pin Configurations

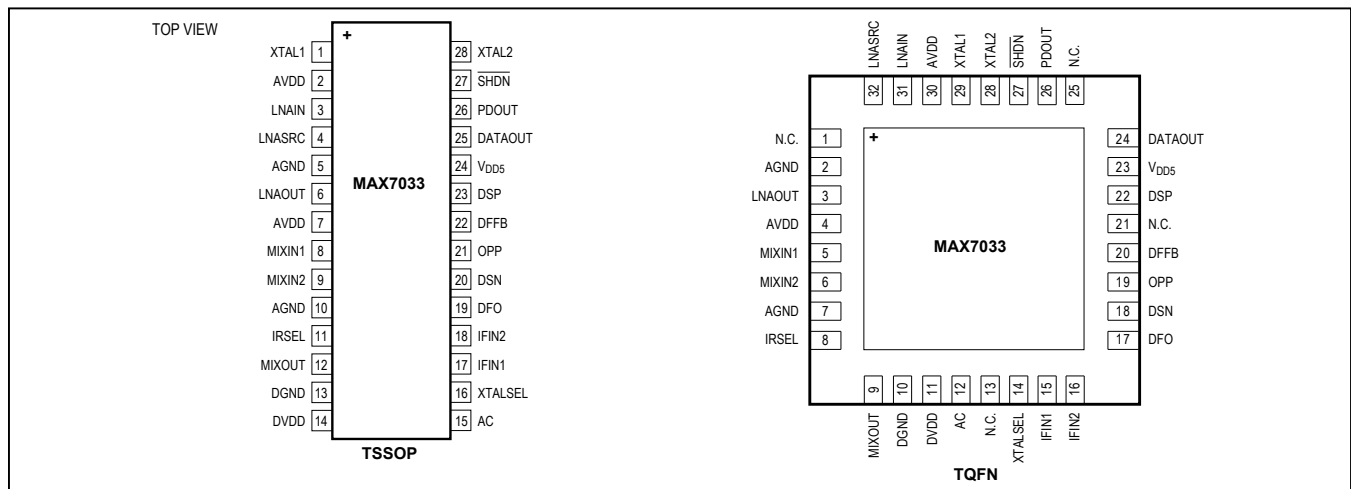

## Features

- Optimized for 315MHz or 433MHz Band
- Operates from Single +3.3V or +5.0V Supplies
- High Dynamic Range with On-Chip AGC
- AGC Hold Circuit
- 1ms AGC Release Time
- Selectable Image-Rejection Center Frequency
- Selectable x64 or x32  $f_{LO}/f_{XTAL}$  Ratio
- Low 5.2mA Operating Supply Current
- < 3.5µA Low-Current Power-Down Mode for Efficient Power Cycling
- 250µs Startup Time
- Built-In 44dB RF Image Rejection
- Better than -114dBm Receive Sensitivity
- -40°C to +105°C Operation

## Ordering Information

PART	TEMP RANGE	PIN-PACKAGE
MAX7033EUI+	-40°C to +105°C	28 TSSOP
MAX7033ETJ+	-40°C to +105°C	32 TQFN-EP*

+Denotes a lead(Pb)-free/RoHS-compliant package.

\*EP = Exposed pad.

Typical Application Circuit appears at end of data sheet.

**Absolute Maximum Ratings**

V<sub>DD5</sub> to AGND .....-0.3V to +6.0V  
 AVDD to AGND .....-0.3V to +4.0V  
 DVDD to DGND.....-0.3V to +4.0V  
 AGND to DGND .....-0.1V to +0.1V  
 IRSEL, DATAOUT, XTALSEL,  
 AC, SHDN to AGND ..... -0.3V to (V<sub>DD5</sub> + 0.3V)  
 All Other Pins to AGND.....-0.3V to (V<sub>DVDD</sub> + 0.3V)

Continuous Power Dissipation (T<sub>A</sub> = +70°C)  
 28-Pin TSSOP (derate 12.8mW/°C above +70°C) 1025.6mW  
 32-Thin QFN (derate 21.3mW/°C above +70°C) ... 1702.1mW  
 Operating Temperature Range..... -40°C to +105°C  
 Junction Temperature..... +150°C  
 Storage Temperature Range..... -60°C to +150°C  
 Lead Temperature (soldering 10s) ..... +300°C  
 Soldering Temperature (reflow)..... +260°C

Stresses beyond those listed under "Absolute Maximum Ratings" may cause permanent damage to the device. These are stress ratings only, and functional operation of the device at these or any other conditions beyond those indicated in the operational sections of the specifications is not implied. Exposure to absolute maximum rating conditions for extended periods may affect device reliability.

**DC Electrical Characteristics (+3.3V Operation)**

(Typical Application Circuit, V<sub>AVDD</sub> = V<sub>DVDD</sub> = V<sub>DD5</sub> = +3.0V to +3.6V, no RF signal applied, T<sub>A</sub> = -40°C to +105°C, unless otherwise noted. Typical values are at V<sub>AVDD</sub> = V<sub>DVDD</sub> = V<sub>DD5</sub> = +3.3V and T<sub>A</sub> = +25°C.) (Note 1)

PARAMETER	SYMBOL	CONDITIONS	MIN	TYP	MAX	UNITS
Supply Voltage	V <sub>AVDD</sub> , V <sub>DVDD</sub>	+3.3V nominal supply voltage	3.0	3.3	3.6	V
Supply Current	I <sub>DD</sub>	V <sub>SHDN</sub> = V <sub>DVDD</sub>		5.2	6.23	mA
		f <sub>RF</sub> = 315MHz				
		f <sub>RF</sub> = 433MHz		5.7	6.88	
Shutdown Supply Current	I <sub>SHDN</sub>	V <sub>SHDN</sub> = 0V, V <sub>XTALSEL</sub> = 0V		2.6		µA
		f <sub>RF</sub> = 315MHz				
		f <sub>RF</sub> = 433MHz		3.5	8.0	
Input-Voltage Low	V <sub>IL</sub>				0.4	V
Input-Voltage High	V <sub>IH</sub>		V <sub>DVDD</sub> - 0.4			V
Input Logic Current High	I <sub>IH</sub>			10		µA
Image-Reject Select Voltage (Note 2)		f <sub>RF</sub> = 433MHz, V <sub>IRSEL</sub> = V <sub>DD5</sub>	V <sub>DD5</sub> - 0.4			V
		f <sub>RF</sub> = 375MHz, V <sub>IRSEL</sub> = V <sub>DD5</sub> /2	1.1	V <sub>DD5</sub> - 1.0		
		f <sub>RF</sub> = 315MHz, V <sub>IRSEL</sub> = 0V			0.4	
DATAOUT Output-Voltage Low	V <sub>OL</sub>	I <sub>SINK</sub> = 10µA		0.125		V
DATAOUT Output-Voltage High	V <sub>OH</sub>	I <sub>SOURCE</sub> = 10µA	V <sub>DVDD</sub> - 0.125			V

**DC Electrical Characteristics (+5.0V Operation)**

(Typical Application Circuit, V<sub>DD5</sub> = +4.5V to +5.5V, no RF signal applied, T<sub>A</sub> = -40°C to +105°C, unless otherwise noted. Typical values are at V<sub>DD5</sub> = +5.0V and T<sub>A</sub> = +25°C.) (Note 1)

PARAMETER	SYMBOL	CONDITIONS	MIN	TYP	MAX	UNITS
Supply Voltage	V <sub>DD5</sub>	+5.0V nominal supply voltage	4.5	5.0	5.5	V
Supply Current	I <sub>DD</sub>	V <sub>SHDN</sub> = V <sub>DD5</sub>	f <sub>RF</sub> = 315MHz	5.2	6.4	mA
			f <sub>RF</sub> = 433MHz	5.7	6.76	
Shutdown Supply Current	I <sub>SHDN</sub>	V <sub>SHDN</sub> = 0V, V <sub>XTALSEL</sub> = 0V	f <sub>RF</sub> = 315MHz	3.7		µA
			f <sub>RF</sub> = 433MHz	4.2	9.8	
Input-Voltage Low	V <sub>IL</sub>				0.4	V

**Electrical Characteristics (continued)**

(Typical Application Circuit,  $V_{DD5} = +4.5V$  to  $+5.5V$ , no RF signal applied,  $T_A = -40^{\circ}C$  to  $+105^{\circ}C$ , unless otherwise noted. Typical values are at  $V_{DD5} = +5.0V$  and  $T_A = +25^{\circ}C$ .) (Note 1)

PARAMETER	SYMBOL	CONDITIONS	MIN	TYP	MAX	UNITS
Input-Voltage High	$V_{IH}$		$V_{DD5} - 0.4$			V
Input Logic Current High	$I_{IH}$		15			$\mu A$
Image-Reject Select Voltage (Note 2)		$f_{RF} = 433MHz, V_{IRSEL} = V_{DD5}$	$V_{DD5} - 0.4$			V
		$f_{RF} = 375MHz, V_{IRSEL} = V_{DD5}/2$	1.1	$V_{DD5} - 1.5$		
		$f_{RF} = 315MHz, V_{IRSEL} = 0V$	0.4			
DATAOUT Output-Voltage Low	$V_{OL}$	$I_{SINK} = 10\mu A$	0.125			V
DATAOUT Output-Voltage High	$V_{OH}$	$I_{SOURCE} = 10\mu A$	$V_{DD5} - 0.125$			V

**AC Electrical Characteristics**

(Typical Application Circuit,  $V_{AVDD} = V_{DVDD} = V_{DD5} = +3.0V$  to  $+3.6V$ , all RF inputs are referenced to  $50\Omega$ ,  $f_{RF} = 315MHz$ ,  $T_A = -40^{\circ}C$  to  $+105^{\circ}C$ , unless otherwise noted. Typical values are at  $V_{AVDD} = V_{DVDD} = V_{DD5} = +3.3V$  and  $T_A = +25^{\circ}C$ .) (Note 1)

PARAMETER	SYMBOL	CONDITIONS	MIN	TYP	MAX	UNITS
<b>GENERAL CHARACTERISTICS</b>						
Startup Time	$t_{ON}$	Time for valid signal detection after $V_{SHDN} = V_{DVDD}$	250			$\mu s$
Receiver Input Frequency	$f_{RF}$		300	450		MHz
Maximum Receiver Input Level		Modulation depth > 18dB	0			dBm
Sensitivity (Note 3)		Average carrier power level	-120			dBm
		Peak power level	-114			
AGC Hysteresis		LNA gain from low to high	8			dB
		Switching time from low to high gain	1			
Maximum Data Rate		Manchester coded	33			kbps
		NRZ coded	66			
<b>LNA IN HIGH-GAIN MODE</b>						
Input Impedance	$Z_{IN\_LNA}$	Normalized to $50\Omega$	$f_{RF} = 433MHz$	1 - j3.4		
			$f_{RF} = 375MHz$	1 - j3.9		
			$f_{RF} = 315MHz$	1 - j4.7		
1dB Compression Point	$P1dB_{LNA}$		-22			dBm
Input-Referred 3rd-Order Intercept	$IIP3_{LNA}$		-12			dBm
LO Signal Feedthrough to Antenna			-80			dBm
Noise Figure	$NF_{LNA}$		3			dB

**Electrical Characteristics (continued)**

(Typical Application Circuit,  $V_{AVDD} = V_{DVDD} = V_{DD5} = +3.0V$  to  $+3.6V$ , all RF inputs are referenced to  $50\Omega$ ,  $f_{RF} = 315MHz$ ,  $T_A = -40^\circ C$  to  $+105^\circ C$ , unless otherwise noted. Typical values are at  $V_{AVDD} = V_{DVDD} = V_{DD5} = +3.3V$  and  $T_A = +25^\circ C$ .) (Note 1)

PARAMETER	SYMBOL	CONDITIONS		MIN	TYP	MAX	UNITS
<b>LNA IN LOW-GAIN MODE</b>							
Input Impedance	$Z_{IN\_LNA}$	Normalized to $50\Omega$ (Note 4)	$f_{RF} = 433MHz$	1 - j3.4			
			$f_{RF} = 375MHz$	1 - j3.9			
			$f_{RF} = 315MHz$	1 - j4.7			
1dB Compression Point	$P1dB_{LNA}$			-10			dBm
Input-Referred 3rd-Order Intercept	$IIP3_{LNA}$			-7			dBm
LO Signal Feedthrough to Antenna				-80			dBm
Noise Figure	$NF_{LNA}$			3			dB
Voltage-Gain Reduction		AGC enabled (depends on tank Q)		35			dB
<b>MIXER</b>							
Input-Referred 3rd-Order Intercept	$IIP3_{MIX}$			-18			dBm
Output Impedance	$Z_{OUT\_MIX}$			330			$\Omega$
Noise Figure	$NF_{MIX}$			16			dB
Image Rejection (Not Including LNA Tank)			$f_{RF} = 433MHz, V_{IRSEL} = V_{DVDD}$	42			dB
			$f_{RF} = 375MHz, V_{IRSEL} = V_{DVDD}/2$	44			
			$f_{RF} = 315MHz, V_{IRSEL} = 0V$	44			
LNA/Mixer Voltage Gain		$330\Omega$ IF filter load	LNA in high-gain mode	48			dB
			LNA in low-gain mode	13			
<b>INTERMEDIATE FREQUENCY (IF)</b>							
Input Impedance	$Z_{IN\_IF}$			330			$\Omega$
Operating Frequency	$f_{IF}$	Bandpass response		10.7			MHz
3dB Bandwidth				10			MHz
RSSI Linearity				$\pm 0.5$			dB
RSSI Dynamic Range				80			dB
RSSI Level			$PRFIN < -120dBm$	1.15			V
			$PRFIN > 0dBm, AGC$ enabled	2.2			
AGC Threshold			LNA gain from low to high	1.39			V
			LNA gain from high to low	1.98			
<b>DATA FILTER</b>							
Maximum Bandwidth				50			kHz
<b>DATA SLICER</b>							
Comparator Bandwidth				100			kHz

Electrical Characteristics (continued)

(Typical Application Circuit,  $V_{AVDD} = V_{DVDD} = V_{DD5} = +3.0V$  to  $+3.6V$ , all RF inputs are referenced to  $50\Omega$ ,  $f_{RF} = 315MHz$ ,  $T_A = -40^\circ C$  to  $+105^\circ C$ , unless otherwise noted. Typical values are at  $V_{AVDD} = V_{DVDD} = V_{DD5} = +3.3V$  and  $T_A = +25^\circ C$ .) (Note 1)

PARAMETER	SYMBOL	CONDITIONS	MIN	TYP	MAX	UNITS
Maximum Load Capacitance	$C_{LOAD}$			10		pF
Output High Voltage				$V_{DD5}$		V
Output Low Voltage				0		V
<b>CRYSTAL OSCILLATOR</b>						
Crystal Frequency (Note 5)	$f_{XTAL}$	$f_{RF} = 433MHz$	$V_{XTALSEL} = 0V$	6.6128		MHz
			$V_{XTALSEL} = V_{DD5}$	13.2256		
		$f_{RF} = 315MHz$	$V_{XTALSEL} = 0V$	4.7547		
			$V_{XTALSEL} = V_{DD5}$	9.5094		
Crystal Tolerance				50		ppm
Input Capacitance		From each pin to ground		6.2		pF

- Note 1:** 100% tested at  $T_A = +25^\circ C$ . Guaranteed by design and characterization over temperature.
- Note 2:** IRSEL is internally set to 375MHz IR mode. It can be left open when the 375MHz image-rejection setting is desired. Bypass to AGND with a 1nF capacitor in a noisy environment.
- Note 3:** BER =  $2 \times 10^{-3}$ , Manchester encoded, data rate = 4kbps, IF bandwidth = 280kHz.
- Note 4:** Input impedance is measured at the LNAIN pin. Note that the impedance includes the 15nH inductive degeneration connected from the LNA source to ground. The equivalent input circuit is  $50\Omega$  in series with 2.2pF.
- Note 5:** Crystal oscillator frequency for other RF carrier frequency within the 300MHz to 450MHz range is  $(f_{RF} - 10.7MHz)/64$  for  $V_{XTALSEL} = 0V$ , and  $(f_{RF} - 10.7MHz)/32$  for  $V_{XTALSEL} = V_{DD5}$ .

Typical Operating Characteristics

(Typical Application Circuit,  $V_{AVDD} = V_{DVDD} = V_{DD5} = +3.3V$ ,  $f_{RF} = 315MHz$ ,  $T_A = +25^\circ C$ , unless otherwise noted.)

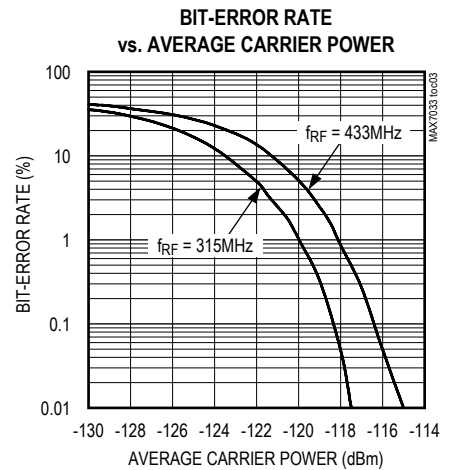
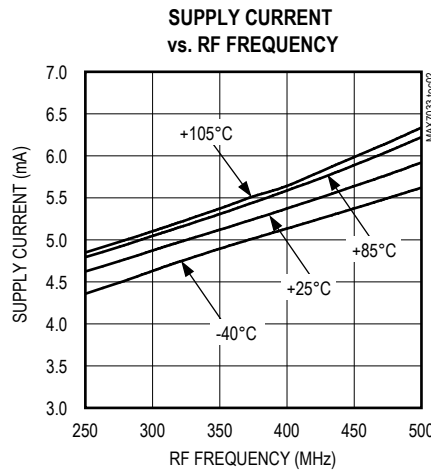
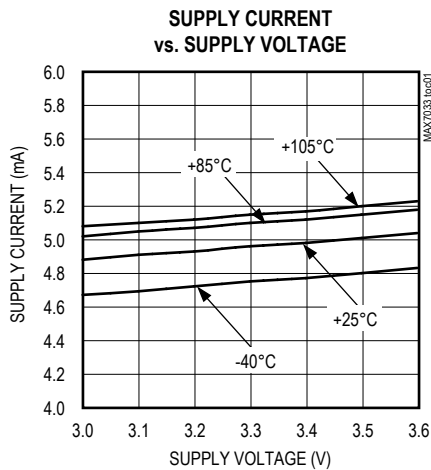

Typical Operating Characteristics (continued)

(Typical Application Circuit,  $V_{AVDD} = V_{DVDD} = V_{DD5} = +3.3V$ ,  $f_{RF} = 315MHz$ ,  $T_A = +25^{\circ}C$ , unless otherwise noted.)

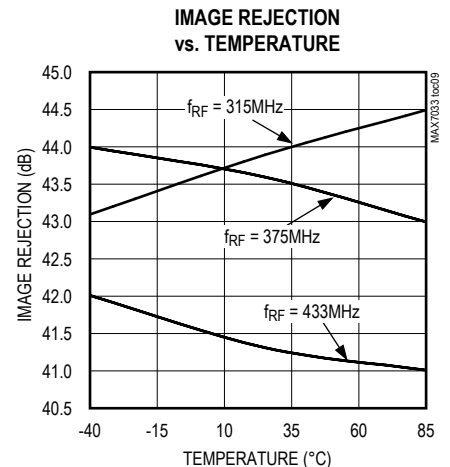
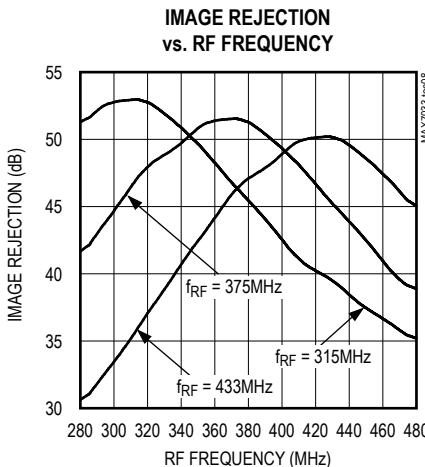
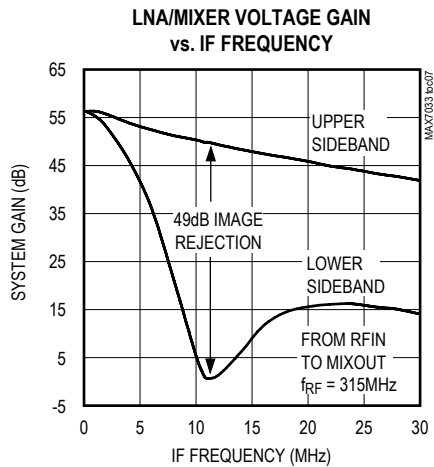
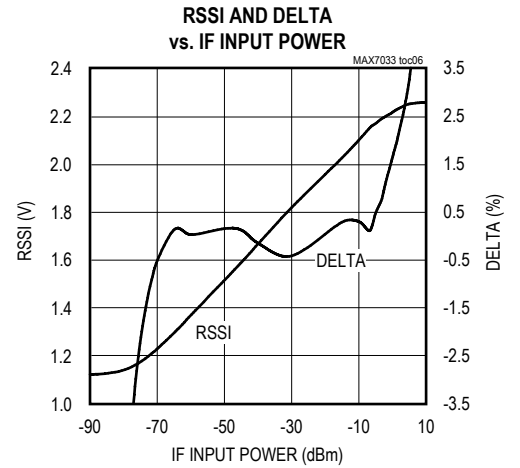
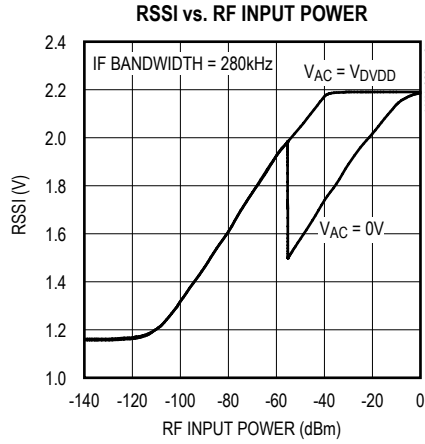
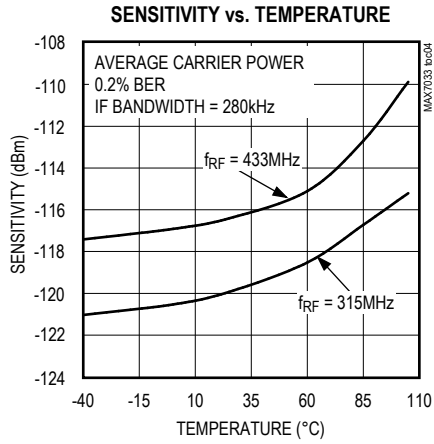

Typical Operating Characteristics (continued)

(Typical Application Circuit,  $V_{AVDD} = V_{DVDD} = V_{DD5} = +3.3V$ ,  $f_{RF} = 315MHz$ ,  $T_A = +25^\circ C$ , unless otherwise noted.)

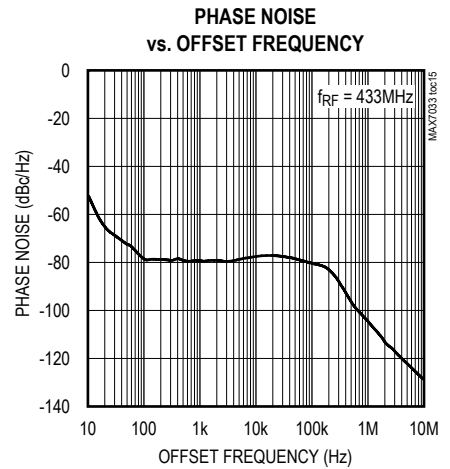
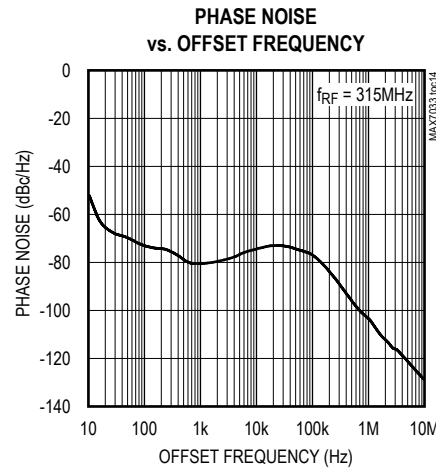
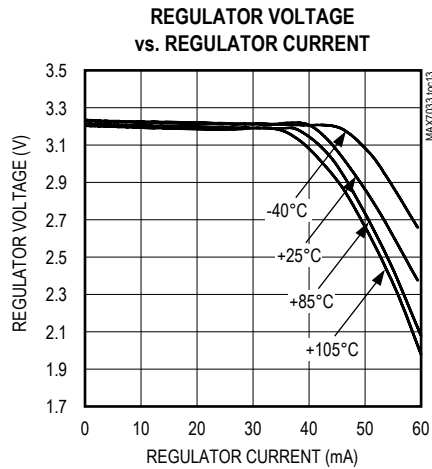
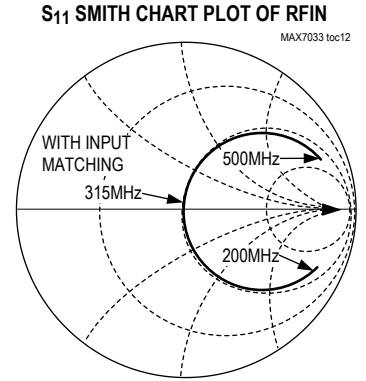
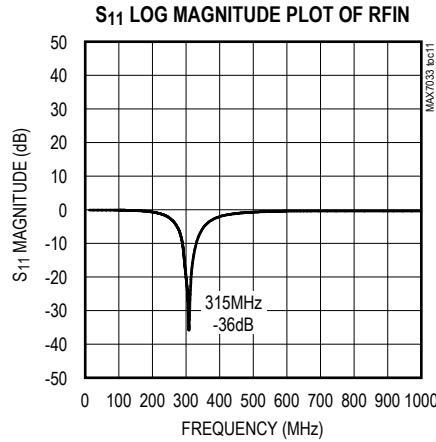
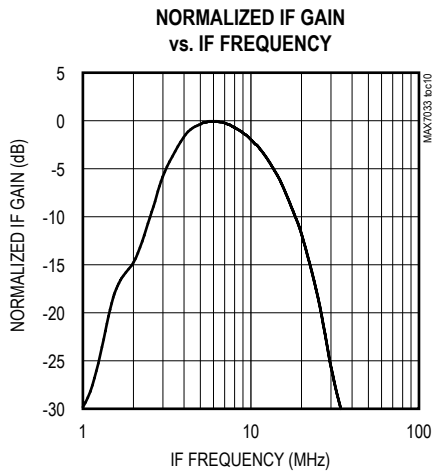

## Pin Description

PIN		NAME	FUNCTION
TSSOP	TQFN		
1	29	XTAL1	Crystal Input 1 (see the <i>Phase-Locked Loop</i> section)
2, 7	4, 30	AVDD	Positive Analog Supply Voltage. For +5V operation, pin 2 is the output of an on-chip +3.2V low-dropout regulator, and should be bypassed to AGND with a 0.1 $\mu$ F capacitor as close as possible to the pin. Pin 7 must be externally connected to the supply from pin 2, and bypassed to AGND with a 0.01 $\mu$ F capacitor as close as possible to the pin (see the <i>Voltage Regulator</i> section and the <i>Typical Application Circuit</i> ).
3	31	LNAIN	Low-Noise Amplifier Input (see the <i>Low-Noise Amplifier</i> section)
4	32	LNASRC	Low-Noise Amplifier Source for External Inductive Degeneration. Connect inductor to ground to set the LNA input impedance (see the <i>Low-Noise Amplifier</i> section).
5, 10	2, 7	AGND	Analog Ground
6	3	LNAOUT	Low-Noise Amplifier Output. Connect to mixer input through an LC tank filter (see the <i>Low-Noise Amplifier</i> section).
8	5	MIXIN1	1st Differential Mixer Input. Connect to LC tank filter from LNAOUT.
9	6	MIXIN2	2nd Differential Mixer Input. Connect through a 100pF capacitor to V <sub>DD3</sub> side of the LC tank.
11	8	IRSEL	Image-Rejection Select. Set V <sub>IRSEL</sub> = 0V to center image rejection at 315MHz. Leave IRSEL unconnected to center image rejection at 375MHz. Set V <sub>IRSEL</sub> = V <sub>DD5</sub> to center image rejection at 433MHz.
12	9	MIXOUT	330 $\Omega$ Mixer Output. Connect to the input of the 10.7MHz bandpass filter.
13	10	DGND	Digital Ground
14	11	DVDD	Positive Digital Supply Voltage. Connect to both of the AVDD pins. Bypass to DGND with a 0.01 $\mu$ F capacitor as close as possible to the pin (see the <i>Typical Application Circuit</i> ).
15	12	AC	Automatic Gain Control. See Figure 1. Internally pulled down to AGND with a 100k $\Omega$ resistor.
16	14	XTALSEL	Crystal Divider Ratio Select. Drive XTALSEL low to select f <sub>LO</sub> /f <sub>XTAL</sub> ratio of 64, or drive XTALSEL high to select f <sub>LO</sub> /f <sub>XTAL</sub> ratio of 32.
17	15	IFIN1	1st Differential Intermediate-Frequency Limiter Amplifier Input. Bypass to AGND with a 1500pF capacitor as close to the pin as possible.
18	16	IFIN2	2nd Differential Intermediate-Frequency Limiter Amplifier Input. Connect to the output of a 10.7MHz bandpass filter.
19	17	DFO	Data Filter Output
20	18	DSN	Negative Data Slicer Input
21	19	OPP	Noninverting Op-Amp Input for the Sallen-Key Data Filter
22	20	DFFB	Data-Filter Feedback Node. Input for the feedback of the Sallen-Key data filter.
23	22	DSP	Positive Data Slicer Input
24	23	V <sub>DD5</sub>	+5V Supply Voltage. Bypass to AGND with a 0.01 $\mu$ F capacitor as close as possible to the pin. For +5V operation, V <sub>DD5</sub> is the input to an on-chip voltage regulator whose +3.2V output appears at the pin 2 AVDD pin (see the <i>Voltage Regulator</i> section and the <i>Typical Application Circuit</i> ).
25	24	DATAOUT	Digital Baseband Data Output
26	26	PDOUT	Peak-Detector Output
27	27	$\overline{\text{SHDN}}$	Power-Down Select Input. Drive high to power up the IC. Internally pulled down to AGND with a 100k $\Omega$ resistor.





The off-chip inductive degeneration is achieved by connecting an inductor from LNASRC to AGND. This inductor sets the real part of the input impedance at LNAIN, allowing for a more flexible input impedance match, such as a typical PCB trace antenna. A nominal value for this inductor with a 50Ω input impedance is 15nH, but is affected by PCB trace.

The LC tank filter connected to LNAOUT comprises L3 and C2 (see the *Typical Application Circuit*). Select L3 and C2 to resonate at the desired RF input frequency. The resonant frequency is given by:

$$f_{RF} = \frac{1}{2\pi\sqrt{L_{TOTAL} \times C_{TOTAL}}}$$

where:

$$L_{TOTAL} = L3 + L_{PARASITICS}$$

$$C_{TOTAL} = C2 + C_{PARASITICS}$$

L<sub>PARASITICS</sub> and C<sub>PARASITICS</sub> include inductance and capacitance of the PCB traces, package pins, mixer input impedance, LNA output impedance, etc. These parasitics at high frequencies cannot be ignored, and can have a dramatic effect on the tank filter center frequency. Lab experimentation should be done to optimize the center frequency of the tank.

**Automatic Gain Control**

When the AC pin is low, the automatic gain-control (AGC) circuit monitors the RSSI output. As the RSSI output reaches 1.98V, which corresponds to RF input level of -62dBm, the AGC switches on the LNA gain reduction

resistor. The resistor reduces the LNA gain by 35dB, thereby reducing the RSSI output by about 500mV. The LNA resumes high-gain mode when the RSSI level drops back below 1.39V (approximately -70dBm at RF input) for 1ms. The AGC has a hysteresis of 8dB. With the AGC function, the MAX7033 can reliably produce an ASK output for RF input levels up to 0dBm with modulation depth of 18dB.

When the AC pin is high and  $\overline{SHDN}$  goes high, the AGC circuit is disabled and the LNA is always in high gain mode. The AGC function can be resumed by bringing the AC pin low when SHDN is high.

The MAX7033 features an AGC lock function that is asserted when the level at the AC pin transitions from low to high while  $\overline{SHDN}$  is high. Locking the AGC locks the LNA in the current gain state. As shown in Figure 1, the AGC lock function can be enabled or disabled as long as the  $\overline{SHDN}$  pin is high. Changing the state of AC when  $\overline{SHDN}$  is low has no effect.

**Mixer**

A unique feature of the MAX7033 is the integrated image rejection of the mixer. This device eliminates the need for a costly front-end SAW filter for most applications. Advantages of not using a SAW filter are increased sensitivity, simplified antenna matching, less board space, and lower cost.

The mixer cell is a pair of double balanced mixers that perform an IQ downconversion of the RF input to the 10.7MHz IF from a low-side injected LO (i.e.,  $f_{LO} = f_{RF} - f_{IF}$ ). The image-rejection circuit then combines these signals to achieve 44dB of image rejection. Low-side injection

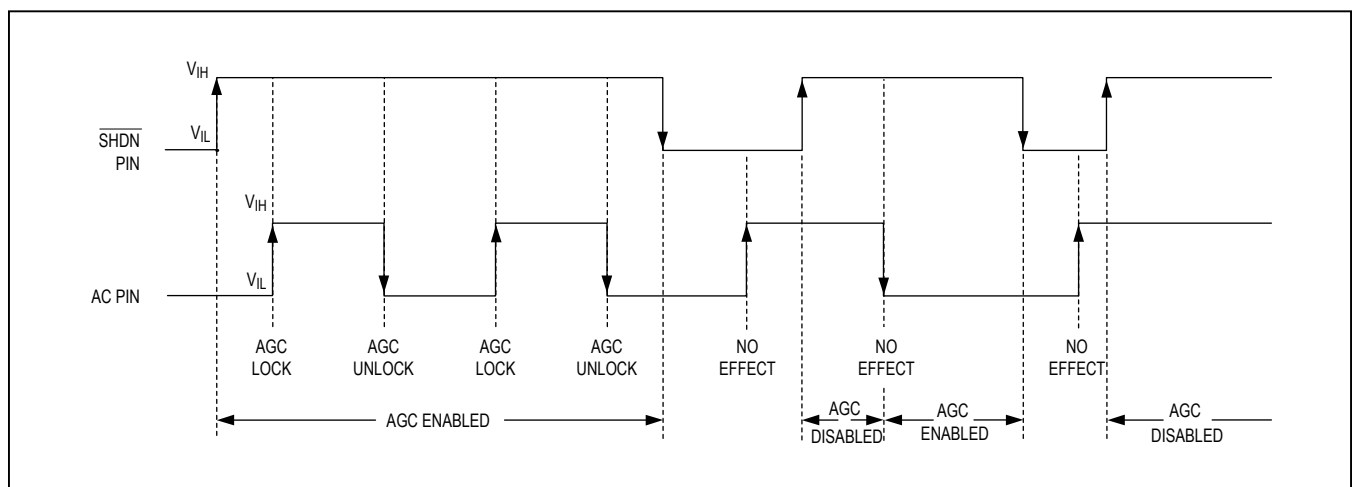

Figure 1. AGC Lock Activation Cycles

is required due to the on-chip image-rejection architecture. The IF output is driven by a source follower biased to create a driving-point impedance of 330Ω; this provides a good match to the off-chip 330Ω ceramic IF filter.

The IRSEL pin is a logic input that selects one of the three possible image-rejection frequencies. When  $V_{IRSEL} = 0V$ , the image rejection is tuned to 315MHz.  $V_{IRSEL} = V_{DD5}/2$  tunes the image rejection to 375MHz, and  $V_{IRSEL} = V_{DD5}$  tunes the image rejection to 433MHz. The IRSEL pin is internally set to  $V_{DD5}/2$  (image rejection at 375MHz) when it is left unconnected, thereby eliminating the need for an external  $V_{DD5}/2$  voltage.

### Phase-Locked Loop

The PLL block contains a phase detector, charge pump, integrated loop filter, VCO, asynchronous 64x clock divider, and crystal oscillator driver. Besides the crystal, this PLL does not require any external components. The VCO generates a low-side LO. The relationship between the RF, IF, and crystal frequencies is given by:

$$f_{XTAL} = \frac{f_{RF} - f_{IF}}{32 \times M}$$

where:

$$M = 1 (V_{XTALSEL} = V_{DD5}) \text{ or } 2 (V_{XTALSEL} = 0V)$$

To allow the smallest possible IF bandwidth (for best sensitivity), minimize the tolerance of the reference crystal.

**Table 1. Component Values for Typical Application Circuit**

COMPONENT	VALUE FOR $f_{RF} = 433MHz$	VALUE FOR $f_{RF} = 315MHz$	DESCRIPTION
C1	100pF	100pF	5%
C2	2pF	4pF	± 0.1pF
C3	100pF	100pF	5%
C4	100pF	100pF	5%
C5	1500pF	1500pF	10%
C6	220pF	220pF	5%
C7	470pF	470pF	5%
C8	0.47μF	0.47μF	20%
C9	220pF	220pF	10%
C10	0.01μF	0.01μF	20%
C11	0.1μF	0.1μF	20%
C12	15pF	15pF	Depends on XTAL
C13	15pF	15pF	Depends on XTAL
C14	0.01μF	0.01μF	20%
C15	0.01μF	0.01μF	20%
L1	56nH	120nH	5% or better*
L2	15nH	15nH	5% or better*
L3	15nH	27nH	5% or better*
R1	5.1kΩ	5.1kΩ	5%
R2	Open	Open	—
R3	Short	Short	—
X1 (+64)	6.6128MHz**	4.7547MHz**	Crystek or Hong Kong Crystal
X1 (+32)	13.2256MHz**	9.5094MHz**	Crystek or Hong Kong Crystal
Y1	10.7MHz ceramic filter	10.7MHz ceramic filter	Murata

\*Wire wound recommended.

\*\*Crystal frequencies shown are for +64 ( $V_{XTALSEL} = 0V$ ) and +32 ( $V_{XTALSEL} = V_{DD}$ )

**Intermediate Frequency and RSSI**

The IF section presents a differential 330Ω load to provide matching for the off-chip ceramic filter. The six internal AC-coupled limiting amplifiers produce an overall gain of approximately 65dB, with a bandpass-filter-type response centered near the 10.7MHz IF frequency 1 with a 3dB bandwidth of approximately 10MHz. The RSSI circuit demodulates the IF by producing a DC output proportional to the log of the IF signal level, with a slope of approximately 14.2mV/dB (see the *Typical Operating Characteristics*).

**Applications Information**

**Crystal Oscillator**

The crystal oscillator in the MAX7033 is designed to present a capacitance of approximately 3pF between the XTAL1 and XTAL2. If a crystal designed to oscillate with a different load capacitance is used, the crystal is pulled away from its stated operating frequency, introducing an error in the reference frequency. Crystals designed to operate with higher differential load capacitance always pull the reference frequency higher. For example, a 4.7547MHz crystal designed to operate with a 10pF load capacitance oscillates at 4.7563MHz with the MAX7033, causing the receiver to be tuned to 315.1MHz rather than 315.0MHz, an error of about 100kHz, or 320ppm.

In actuality, the oscillator pulls every crystal. The crystal's natural frequency is really below its specified frequency, but when loaded with the specified load capacitance, the crystal is pulled and oscillates at its specified frequency. This pulling is already accounted for in the specification of the load capacitance. Additional pulling can be calculated if the electrical parameters of the crystal are known. The frequency pulling is given by:

$$f_P = \frac{C_M}{2} \left( \frac{1}{C_{CASE} + C_{LOAD}} - \frac{1}{C_{CASE} + C_{SPEC}} \right) \times 10^6$$

where:

$f_P$  is the amount the crystal frequency pulled in ppm.

$C_M$  is the motional capacitance of the crystal.

$C_{CASE}$  is the case capacitance.

$C_{SPEC}$  is the specified load capacitance.

$C_{LOAD}$  is the actual load capacitance.

When the crystal is loaded as specified, i.e.,  $C_{LOAD} = C_{SPEC}$ , the frequency pulling equals zero.

It is possible to use an external reference oscillator in place of a crystal to drive the VCO. AC-couple the external oscillator to XTAL2 with a 1000pF capacitor. Drive XTAL2 with a signal level of approximately -10dBm. AC-couple XTAL1 to ground with a 1000pF capacitor.

**Data Filter**

The data filter is implemented as a 2nd-order lowpass Sallen-Key filter. The pole locations are set by the combination of two on-chip resistors and two external capacitors. Adjusting the value of the external capacitors changes the corner frequency to optimize for different data rates. The corner frequency should be set to approximately 1.5 times the fastest expected data rate from the transmitter. Keeping the corner frequency near the data rate rejects any noise at higher frequencies, resulting in an increase in receiver sensitivity.

The configuration shown in Figure 2 can create a Butterworth or Bessel response. The Butterworth filter offers a very flat amplitude response in the passband and a rolloff rate of 40dB/decade for the two-pole filter. The Bessel filter has a linear phase response, which works well for filtering digital data. To calculate the value of C5 and C6, use the following equations, along with the coefficients in Table 2:

$$C_5 = \frac{b}{a(100k)(\pi)(f_C)}$$

$$C_6 = \frac{a}{4(100k)(\pi)(f_C)}$$

where  $f_C$  is the desired 3dB corner frequency.

**Table 2. Coefficients to Calculate C5 and C6**

FILTER TYPE	a	b
Butterworth (Q = 0.707)	1.414	1.000
Bessel (Q = 0.577)	1.3617	0.618

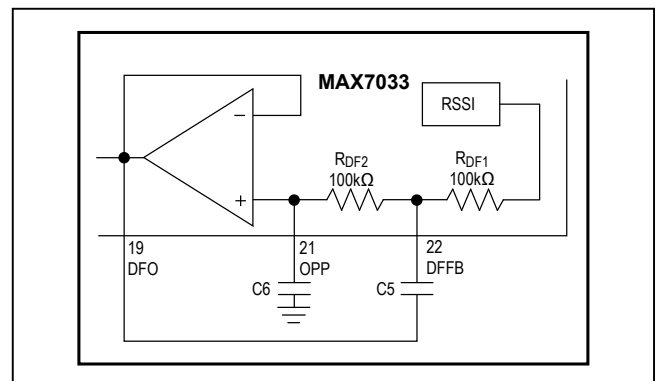

Figure 2. Sallen-Key Lowpass Data Filter

For example, to choose a Butterworth filter response with a corner frequency of 5kHz:

$$C5 = \frac{1.000}{(1.414)(100k\Omega)(3.14)(5kHz)} \approx 450pF$$

$$C6 = \frac{1.414}{(4)(100k\Omega)(3.14)(5kHz)} \approx 225pF$$

Choosing standard capacitor values changes C5 to 470pF and C6 to 220pF, as shown in the *Typical Application Circuit*.

**Data Slicer**

The data slicer takes the analog output of the data filter and converts it to a digital signal. This is achieved by using a comparator and comparing the analog input to a threshold voltage. One input is supplied by the data filter output. Both comparator inputs are accessible offchip to allow for different methods of generating the slicing threshold, which is applied to the second comparator input.

The suggested data slicer configuration uses a resistor (R1) connected between DSN and DSP with a capacitor (C4) from DSN to DGND (Figure 3). This configuration averages the analog output of the filter and sets the threshold to approximately 50% of that amplitude. With this configuration, the threshold automatically adjusts as the analog signal varies, minimizing the possibility for errors in the digital data. The values of R1 and C4 affect how fast the threshold tracks to the analog amplitude. Be sure to keep the corner frequency of the RC circuit much lower than the lowest expected data rate.

Note that a long string of zeros or ones can cause the threshold to drift. This configuration works best if a coding scheme, such as Manchester coding, which has an equal number of zeros and ones, is used.

To prevent continuous toggling of DATAOUT in the absence of an RF signal due to noise, add hysteresis to the data slicer as shown in Figure 4.

**Peak Detector**

The peak-detector output (PDOUT), in conjunction with an external RC filter, creates a DC output voltage equal to the peak value of the data signal. The resistor provides a path for the capacitor to discharge, allowing the peak detector to dynamically follow peak changes of the data-filter output voltage. For faster data slicer response, use the circuit shown in Figure 5.

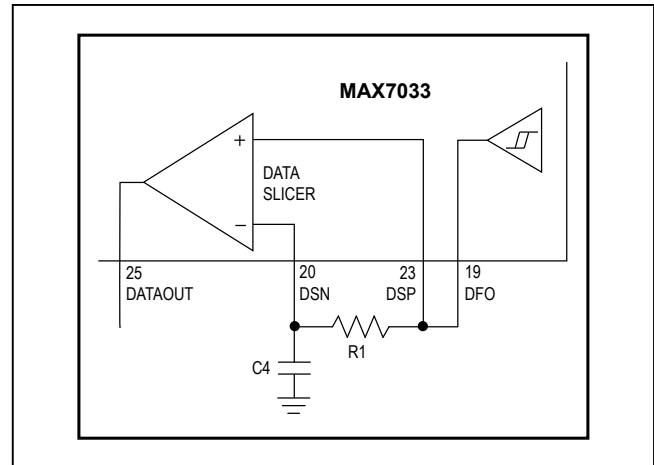

Figure 3. Generating Data Slicer Threshold

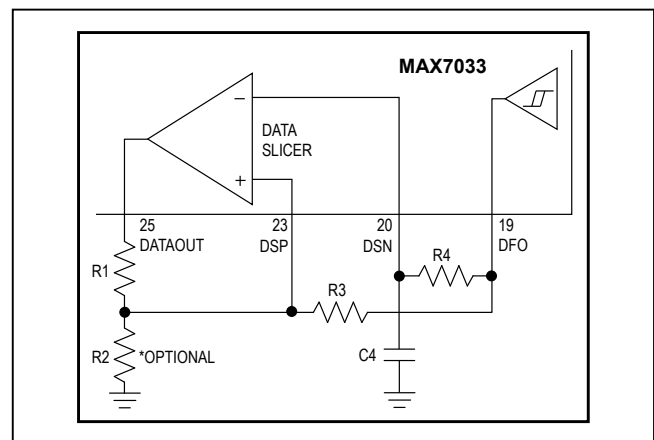

Figure 4. Generating Data Slicer Hysteresis

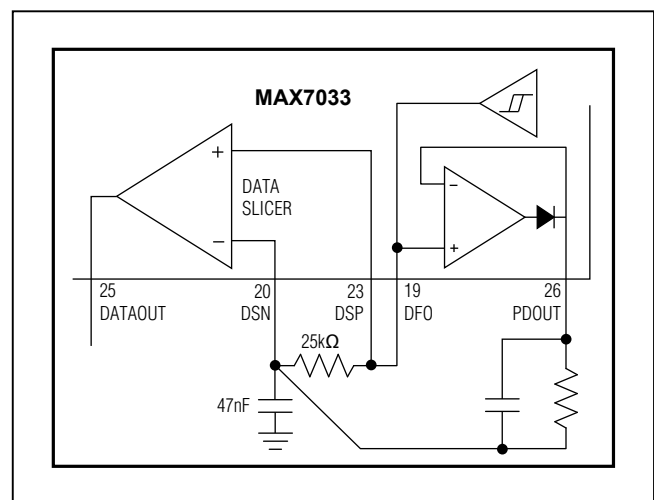

Figure 5. Using PDOUT for Faster Startup

**Layout Considerations**

A properly designed PCB is an essential part of any RF/microwave circuit. On high-frequency inputs and outputs, use controlled-impedance lines and keep them as short as possible to minimize losses and radiation. At high frequencies, trace lengths that are on the order of  $\lambda/10$  or longer act as antennas.

Keeping the traces short also reduces parasitic inductance. Generally, 1in of a PCB trace adds about 20nH of parasitic inductance. The parasitic inductance can have a dramatic effect on the effective inductance of a passive component. For example, a 0.5in trace connecting a 100nH inductor adds an extra 10nH of inductance or 10%.

To reduce the parasitic inductance, use wider traces and a solid ground or power plane below the signal traces. Also, use low-inductance connections to ground on all GND pins, and place decoupling capacitors close to all power-supply pins.

**Control Interface Considerations**

When operating the MAX7033 with a +4.5V to +5.5V supply voltage, the  $\overline{\text{SHDN}}$  and AC pins can be driven by a microcontroller with either 3V or 5V interface logic levels. When operating the MAX7033 with a +3.0V to +3.6V supply, only 3V logic from the microcontroller is allowed.

**Typical Application Circuit**

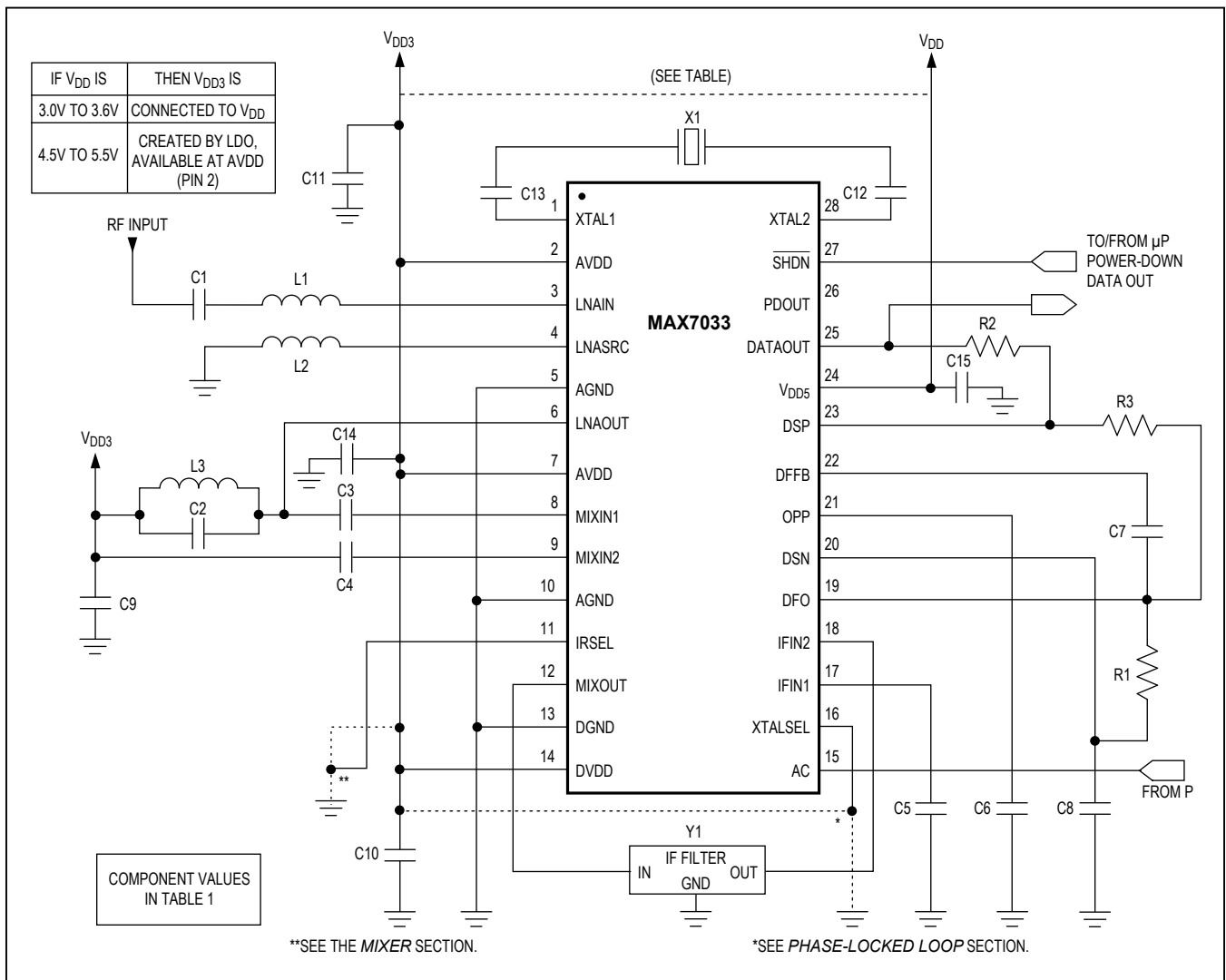

### Chip Information

PROCESS: CMOS

### Package Information

For the latest package outline information and land patterns (footprints), go to [www.maximintegrated.com/packages](http://www.maximintegrated.com/packages). Note that a "+", "#", or "-" in the package code indicates RoHS status only. Package drawings may show a different suffix character, but the drawing pertains to the package regardless of RoHS status.

PACKAGE TYPE	PACKAGE CODE	OUTLINE NO.	LAND PATTERN NO.
28 TSSOP	U28+1	<a href="#">21-0066</a>	<a href="#">90-0171</a>
32 TQFN-EP	T3255+3	<a href="#">21-0140</a>	<a href="#">90-0001</a>

## Revision History

REVISION NUMBER	REVISION DATE	DESCRIPTION	PAGES CHANGED
0	7/04	Initial release	—
1	1/11	Updated <i>Ordering Information</i> , <i>Pin Configurations</i> , <i>Absolute Maximum Ratings</i> , <i>DC Electrical Characteristics</i> , <i>AC Electrical Characteristics</i> , <i>Typical Operating Characteristics</i> , <i>Pin Description</i> , <i>Functional Diagram</i> , <i>Voltage Regulator and Layout Considerations</i> sections, <i>Typical Application Circuit</i> , <i>Chip Information</i> , and <i>Package Information</i>	1–9, 13, 14, 15
2	9/11	Updated input impedance values in <i>AC Electrical Characteristics</i> table; updated TOC3 and TOC4 labels in <i>Typical Operating Characteristics</i> ; clarified equations in <i>Pin Description</i> and <i>Phase-Locked Loop</i> and <i>Crystal Oscillator</i> sections; updated components in Table 1; and added new <i>Control Interface Considerations</i> section	3–6, 11–14
3	4/14	Updated <i>Applications</i> and <i>General Description</i>	1

For pricing, delivery, and ordering information, please contact Maxim Direct at 1-888-629-4642, or visit Maxim Integrated's website at [www.maximintegrated.com](http://www.maximintegrated.com).

Maxim Integrated cannot assume responsibility for use of any circuitry other than circuitry entirely embodied in a Maxim Integrated product. No circuit patent licenses are implied. Maxim Integrated reserves the right to change the circuitry and specifications without notice at any time. The parametric values (min and max limits) shown in the *Electrical Characteristics* table are guaranteed. Other parametric values quoted in this data sheet are provided for guidance.



Компания «Life Electronics» занимается поставками электронных компонентов импортного и отечественного производства от производителей и со складов крупных дистрибьюторов Европы, Америки и Азии.

С конца 2013 года компания активно расширяет линейку поставок компонентов по направлению коаксиальный кабель, кварцевые генераторы и конденсаторы (керамические, пленочные, электролитические), за счёт заключения дистрибьюторских договоров

Мы предлагаем:

- Конкуренеспособные цены и скидки постоянным клиентам.
- Специальные условия для постоянных клиентов.
- Подбор аналогов.
- Поставку компонентов в любых объемах, удовлетворяющих вашим потребностям.
- Приемлемые сроки поставки, возможна ускоренная поставка.
- Доставку товара в любую точку России и стран СНГ.
- Комплексную поставку.
- Работу по проектам и поставку образцов.
- Формирование склада под заказчика.
- Сертификаты соответствия на поставляемую продукцию (по желанию клиента).
- Тестирование поставляемой продукции.
- Поставку компонентов, требующих военную и космическую приемку.
- Входной контроль качества.
- Наличие сертификата ISO.

В составе нашей компании организован Конструкторский отдел, призванный помогать разработчикам, и инженерам.

Конструкторский отдел помогает осуществить:

- Регистрацию проекта у производителя компонентов.
- Техническую поддержку проекта.
- Защиту от снятия компонента с производства.
- Оценку стоимости проекта по компонентам.
- Изготовление тестовой платы монтаж и пусконаладочные работы.



Тел: +7 (812) 336 43 04 (многоканальный)

Email: [org@lifeelectronics.ru](mailto:org@lifeelectronics.ru)