

■ Ratings

Item	H3Y-2(-0)/H3Y-4(-0)
Rated supply voltage (See note 6.)	24, 100 to 120 (50/60 Hz), 200 to 230 VAC (50/60 Hz) (See note 1.), 12, 24, 48, 125, 100 to 110 VDC (See notes 2 and 3.)
Operating voltage range	All rated voltages except 12 VDC: 85% to 110% of rated supply voltage 12 VDC: 90% to 110% of rated supply voltage (See note 4.)
Reset voltage	10% min. of rated supply voltage (See note 5.)
Power consumption	100 to 120 VAC: Relay ON: Approx. 1.8 VA (1.6 W) at 120 VAC, 60 Hz Relay OFF: Approx. 1 VA (0.6 W) at 120 VAC, 60 Hz 200 to 230 VAC: Relay ON: Approx. 2.2 VA (1.8 W) at 230 VAC, 60 Hz Relay OFF: Approx. 1.5 VA (1.1 W) at 230 VAC, 60 Hz 24 VAC: Relay ON: Approx. 1.8 VA (1.4 W) at 24 VAC, 60 Hz Relay OFF: Approx. 0.3 VA (0.2 W) at 24 VAC, 60 Hz 12 VDC: Relay ON: Approx. 1.1 W at 12 VDC Relay OFF: Approx. 0.1 W at 12 VDC 24 VDC: Relay ON: Approx. 1.1 W at 24 VDC Relay OFF: Approx. 0.1 W at 24 VDC 48 VDC: Relay ON: Approx. 1.2 W at 48 VDC Relay OFF: Approx. 0.3 W at 48 VDC 100 to 110 VDC: Relay ON: Approx. 1.6 W at 110 VDC Relay OFF: Approx. 0.4 W at 110 VDC 125 VDC: Relay ON: Approx. 1.6 W at 125 VDC Relay OFF: Approx. 0.4 W at 125 VDC
Control outputs	H3Y-2(-0): 5 A at 250 VAC, resistive load ($\cos\phi = 1$) H3Y-4(-0): 3 A at 250 VAC, resistive load ($\cos\phi = 1$)

- Note:**
- Do not use the output from an inverter as the power supply. Refer to *Safety Precautions for All Times* for details.
 - With DC ratings, single-phase full-wave rectified power sources may be used.
 - Only the H3Y-2 and H3Y-2-0 Series include 2-VDC models.
 - Use the Timer within 90% to 110% of the rated supply voltage (95% to 110% for 12 VDC) when using it continuously under an ambient operating temperature of 50°C.
 - Set the reset voltage as follows to ensure proper resetting.
 - 100 to 120 VAC: 10 VAC max.
 - 200 to 230 VAC: 20 VAC max.
 - 100 to 110 VDC: 10 VDC max.
 - Refer to *Safety Precautions for All Times* when combining the Timer with an AC 2-wire proximity sensor.

■ Characteristics

Accuracy of operating time	±1% FS max. (0.5 s range: ±1%±10 ms max.)
Setting error (see note 1)	±10%±50 ms FS max.
Reset time	Min. power-opening time: 0.1 s max. (including halfway reset)
Reset voltage	10% max. of rated supply voltage
Influence of voltage (see note 1)	±2% FS max.
Influence of temperature (see note 1)	±2% FS max.
Insulation resistance	100 MΩ min. (at 500 VDC)
Dielectric strength	2,000 VAC, 50/60 Hz for 1 min (between current-carrying terminals and exposed non-current-carrying metal parts) (see note 2) 2,000 VAC, 50/60 Hz for 1 min (between operating power circuit and control output) (see note 2) 2,000 VAC, 50/60 Hz for 1 min (between different pole contacts; 2-pole model) (see note 2) 1,500 VAC, 50/60 Hz for 1 min (between different pole contacts; 4-pole model) 1,000 VAC, 50/60 Hz for 1 min (between non-continuous contacts)
Vibration resistance	Destruction: 10 to 55 Hz, 0.75-mm single amplitude Malfunction: 10 to 55 Hz, 0.5-mm single amplitude
Shock resistance	Destruction: 1,000 m/s ² (approx. 100G) Malfunction: 100 m/s ² (approx. 10G)
Ambient temperature	Operating: -10°C to 50°C (with no icing) Storage: -25°C to 65°C (with no icing)
Ambient humidity	Operating: 35% to 85%
Life expectancy	Mechanical: 10,000,000 operations min. (under no load at 1,800 operations/h) Electrical: H3Y-2: 500,000 operations min. (5 A at 250 VAC, resistive load at 1800 operations/h) H3Y-4: 200,000 operations min. (3 A at 250 VAC, resistive load at 1800 operations/h)
Impulse withstand voltage	Between power terminals: 3 kV for 100 to 120 VAC, 200 to 230 VAC, 100 to 110 VDC, 125 VDC 1 kV for 12 VDC, 24 VDC, 48 VDC Between exposed non-current-carrying metal parts: 4.5 kV for 100 to 120 VAC, 200 to 230 VAC, 100 to 110 VDC, 125 VDC 1.5 kV for 12 VDC, 24 VDC, 48 VDC
Noise immunity	±1.5 kV, square-wave noise by noise simulator (pulse width: 100 ns/1 μs, 1-ns rise)
Static immunity	Destruction: 8 kV Malfunction: 4 kV
Enclosure rating	IP40
Weight	Approx. 50 g
EMC	(EMI) EN61812-1 Emission Enclosure: EN55011 Group 1 class A Emission AC Mains: EN55011 Group 1 class A (EMS) EN61812-1 Immunity ESD: EN61000-4-2: 8 kV air discharge (level 3) Immunity RF-interference from AM Radio Waves: EN61000-4-3: 10 V/m (80 MHz to 1 GHz) (level 3) Immunity Burst: EN61000-4-4: 2 kV power-line (level 3) 2 kV I/O signal-line (level 4) Immunity Surge: EN61000-4-5: 2 kV line to ground (level 3) 1 kV line to line (level 3)
Approved standards	UL508, CSA C22.2 No. 14, Lloyds Conforms to EN61812-1 and IEC60664-1. (2.5 kV/2 for H3Y-2/-2-0, 2.5 kV/1 for H3Y-4/-4-0) Output category according to EN60947-5-1.

- Note:** 1. Add ±10 mS to the above value for the 0.5-S range model.
2. Terminal screw sections are excluded.

Engineering Data

H3Y-2, H3Y-2-0



H3Y-2, H3Y-2-0



Reference: A maximum current of 0.6 A can be switched at 125 VDC ($\cos\phi = 1$).
Maximum current of 0.2 A can be switched if L/R is 7 ms. In both cases, a life of 100,000 operations can be expected. The minimum applicable load is 1 mA at 5 VDC (P reference value).

H3Y-4, H3Y-4-0

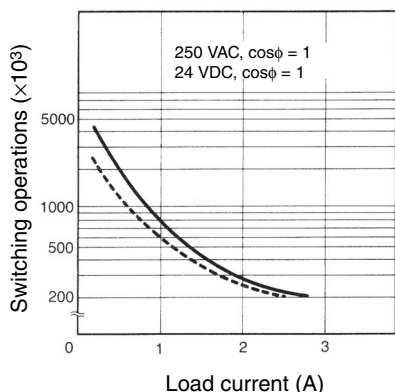

H3Y-4, H3Y-4-0



Reference: A maximum current of 0.5 A can be switched at 125 VDC ($\cos\phi = 1$).
Maximum current of 0.2 A can be switched if L/R is 7 ms. In both cases, a life of 100,000 operations can be expected. The minimum applicable load is 1 mA at 1 VDC (P reference value).

Operation

Timing Chart

H3Y-2, H3Y-2-0



H3Y-4, H3Y-4-0



Dimensions

Note: All units are in millimeters unless otherwise indicated.

Timers

H3Y-2



H3Y-4

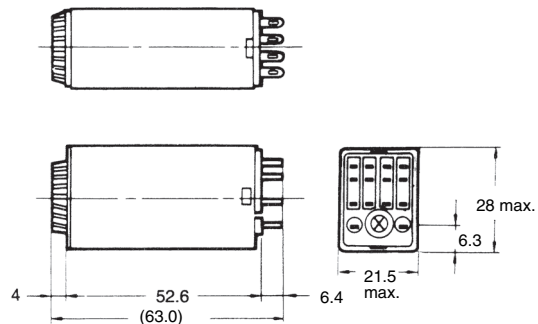

H3Y-2-0



H3Y-4-0

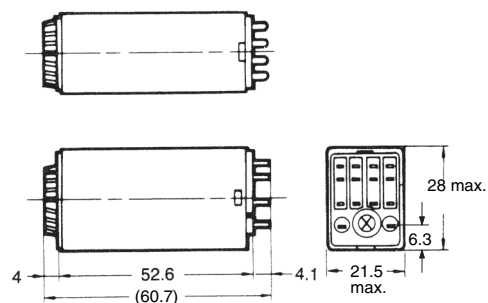

Mounting Holes



Mounting Holes



■ Accessories (Order Separately)

Use the PYF□A, PY□, PY□-02, or PY□QN(2) to mount the H3Y. When ordering any one of these sockets, replace "□" with "08" or "14."

Track Mounting/Front Connecting Sockets

PYF08A



Terminal Arrangement (Top View)



Mounting Holes



PYF14A



Terminal Arrangement (Top View)



Mounting Holes

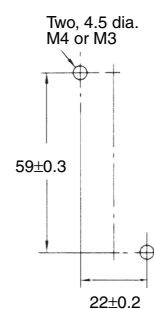

PYF08A-N

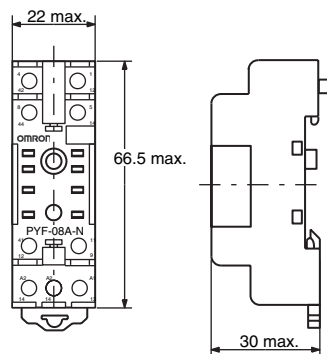

Terminal Arrangement



Mounting Holes (for Surface Mounting)



PYF14A-N

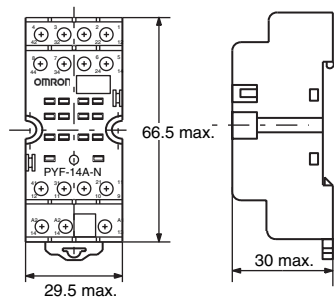

Terminal Arrangement

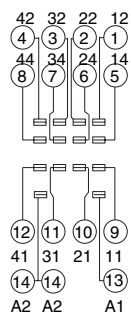

Mounting Holes (for Surface Mounting)

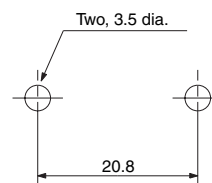

PYF08A-E



(Top View)



PYF14A-E

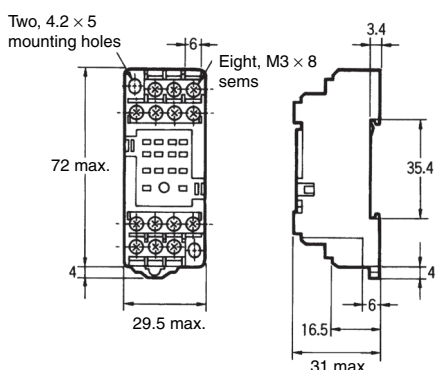

(Top View)

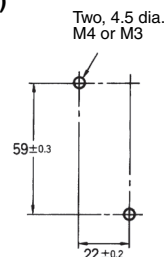

Back Connecting Sockets

PY08, PY14

Eight, 3 × 1.2 dia. holes only for PY08 (Fourteen, 3 × 1.2 dia. holes)

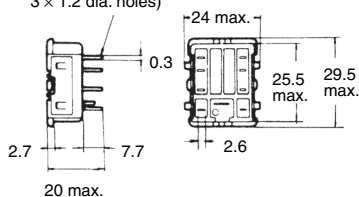

Terminal Arrangement (Bottom View)



PY08

PY14

Panel Cutout



PY□, PY□-02, PY□QN(2)

PY08QN, PY14QN PY08QN(2), PY14QN(2)



Terminal Arrangement (Bottom View)



PY08QN
PY08QN(2)

PY14QN
PY14QN(2)

Note: With PY□QN(2), dimension * should read 20 max. and dimension ** 36.5 max.

PY08-02, PY14-02

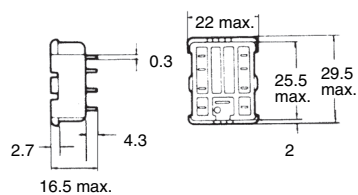

Terminal Arrangement (Bottom View)

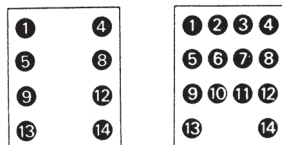

PY08-02

PY14-02

Socket Mounting Plates (t = 1.6)

Applicable socket	For mounting 1 socket	For mounting 18 sockets
PY08, PY14, PY08QN(2), PY14QN(2)	PYP-1	PYP-18

Note: PYP-18 may be cut to any desired length.

PYP-1



PYP-18



Relay Hold-down Clips



Y92H-3 for PYF□A Socket (Set of Two Clips)



Y92H-4 for PY□ Socket



Mounting Track

PF-P100N/PFP-50N (see note 1)



End Plate

PFP-M

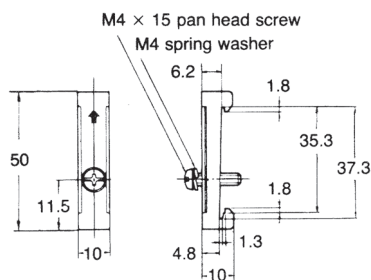

Note: 1. Meets DIN EN50022
2. This dimension applies to PFP-50N.

Spacer

PFP-S



Installation

■ Connection

H3Y-2, H3Y-2-0



Connect the DC power supply to terminals 13 and 14 according to the polarity marks.

H3Y-4, H3Y-4-0



Connect the DC power supply to terminals 13 and 14 according to the polarity marks.

Safety Precautions

Refer to *Safety Precautions for All Timers*.

When selecting a control output, use the H3Y-2 for switching ON and OFF the power and the H3Y-4 for switching ON and OFF the minute load.

The operating voltage will increase when using the H3Y in any place where the ambient temperature is more than 50°C. Supply 90% to 110% of the rated voltages (at 12 VDC: 95% to 110%) when operating at 45°C or higher.

Do not leave the H3Y in time-up condition for a long period of time (for example, more than one month in any place where the ambient temperature is high), otherwise the internal parts (aluminum electrolytic capacitor) may become damaged. Therefore, the use of the H3Y with a relay as shown in the following circuit diagram is recommended to extend the service life of the H3Y.



(X) : Auxiliary relay such as MY Relay

Do not connect the H3Y as shown in the following circuit diagram on the right hand side, otherwise the H3Y's internal contacts different from each other in polarity may become short-circuited.



Use the following safety circuit when building a self-holding or self-resetting circuit with the H3Y and an auxiliary relay, such as an MY Relay, in combination.



Do not use the H3Y in places where there is excessive dust, corrosive gas, or direct sunlight.

Do not mount more than one H3Y closely together, otherwise the internal parts may become damaged. Make sure that there is a space of 5 mm or more between any H3Y Models next to each other to allow heat radiation.

The internal parts may become damaged if a supply voltage other than the rated ones is imposed on the H3Y. When more than 100 V is applied to 12- or 24-VDC models, the internal element (varistor) may break.

Precautions for EN61812-1

Conformance

The H3Y as a built-in timer conforms to EN61812-1 provided that the following conditions are satisfied.

Handling

Before dismantling the H3Y from the socket, make sure that no voltage is imposed on any terminal of the H3Y.

Wiring

The power supply for the H3Y must be protected with equipment such as a breaker approved by VDE.

Basic insulation is ensured between the H3Y's operating circuit and control output.

Insulation requirement: Overvoltage category II, pollution degree 1 (H3Y-4/-4-0), pollution degree 2 (H3Y-2/-2-0) (with a clearance of 1.5 mm and a creepage distance of 2.5 mm at 240 VAC)

Output terminals next to each other on the H3Y-4 or H3Y-4-0 must have the same polarity.

ALL DIMENSIONS SHOWN ARE IN MILLIMETERS.

To convert millimeters into inches, multiply by 0.03937. To convert grams into ounces, multiply by 0.03527.

In the interest of product improvement, specifications are subject to change without notice.

Read and Understand This Catalog

Please read and understand this catalog before purchasing the products. Please consult your OMRON representative if you have any questions or comments.

Warranty and Limitations of Liability

WARRANTY

OMRON's exclusive warranty is that the products are free from defects in materials and workmanship for a period of one year (or other period if specified) from date of sale by OMRON.

OMRON MAKES NO WARRANTY OR REPRESENTATION, EXPRESS OR IMPLIED, REGARDING NON-INFRINGEMENT, MERCHANTABILITY, OR FITNESS FOR PARTICULAR PURPOSE OF THE PRODUCTS. ANY BUYER OR USER ACKNOWLEDGES THAT THE BUYER OR USER ALONE HAS DETERMINED THAT THE PRODUCTS WILL SUITABLY MEET THE REQUIREMENTS OF THEIR INTENDED USE. OMRON DISCLAIMS ALL OTHER WARRANTIES, EXPRESS OR IMPLIED.

LIMITATIONS OF LIABILITY

OMRON SHALL NOT BE RESPONSIBLE FOR SPECIAL, INDIRECT, OR CONSEQUENTIAL DAMAGES, LOSS OF PROFITS OR COMMERCIAL LOSS IN ANY WAY CONNECTED WITH THE PRODUCTS, WHETHER SUCH CLAIM IS BASED ON CONTRACT, WARRANTY, NEGLIGENCE, OR STRICT LIABILITY.

In no event shall the responsibility of OMRON for any act exceed the individual price of the product on which liability is asserted.

IN NO EVENT SHALL OMRON BE RESPONSIBLE FOR WARRANTY, REPAIR, OR OTHER CLAIMS REGARDING THE PRODUCTS UNLESS OMRON'S ANALYSIS CONFIRMS THAT THE PRODUCTS WERE PROPERLY HANDLED, STORED, INSTALLED, AND MAINTAINED AND NOT SUBJECT TO CONTAMINATION, ABUSE, MISUSE, OR INAPPROPRIATE MODIFICATION OR REPAIR.

Application Considerations

SUITABILITY FOR USE

OMRON shall not be responsible for conformity with any standards, codes, or regulations that apply to the combination of products in the customer's application or use of the products.

At the customer's request, OMRON will provide applicable third party certification documents identifying ratings and limitations of use that apply to the products. This information by itself is not sufficient for a complete determination of the suitability of the products in combination with the end product, machine, system, or other application or use.

The following are some examples of applications for which particular attention must be given. This is not intended to be an exhaustive list of all possible uses of the products, nor is it intended to imply that the uses listed may be suitable for the products:

- Outdoor use, uses involving potential chemical contamination or electrical interference, or conditions or uses not described in this catalog.
- Nuclear energy control systems, combustion systems, railroad systems, aviation systems, medical equipment, amusement machines, vehicles, safety equipment, and installations subject to separate industry or government regulations.
- Systems, machines, and equipment that could present a risk to life or property.

Please know and observe all prohibitions of use applicable to the products.

NEVER USE THE PRODUCTS FOR AN APPLICATION INVOLVING SERIOUS RISK TO LIFE OR PROPERTY WITHOUT ENSURING THAT THE SYSTEM AS A WHOLE HAS BEEN DESIGNED TO ADDRESS THE RISKS, AND THAT THE OMRON PRODUCTS ARE PROPERLY RATED AND INSTALLED FOR THE INTENDED USE WITHIN THE OVERALL EQUIPMENT OR SYSTEM.

PROGRAMMABLE PRODUCTS

OMRON shall not be responsible for the user's programming of a programmable product, or any consequence thereof.

Disclaimers

CHANGE IN SPECIFICATIONS

Product specifications and accessories may be changed at any time based on improvements and other reasons.

It is our practice to change model numbers when published ratings or features are changed, or when significant construction changes are made. However, some specifications of the products may be changed without any notice. When in doubt, special model numbers may be assigned to fix or establish key specifications for your application on your request. Please consult with your OMRON representative at any time to confirm actual specifications of purchased products.

DIMENSIONS AND WEIGHTS

Dimensions and weights are nominal and are not to be used for manufacturing purposes, even when tolerances are shown.

PERFORMANCE DATA

Performance data given in this catalog is provided as a guide for the user in determining suitability and does not constitute a warranty. It may represent the result of OMRON's test conditions, and the users must correlate it to actual application requirements. Actual performance is subject to the OMRON Warranty and Limitations of Liability.

ERRORS AND OMISSIONS

The information in this document has been carefully checked and is believed to be accurate; however, no responsibility is assumed for clerical, typographical, or proofreading errors, or omissions.

2008.11

In the interest of product improvement, specifications are subject to change without notice.

OMRON Corporation
Industrial Automation Company

<http://www.ia.omron.com/>

(c)Copyright OMRON Corporation 2008 All Right Reserved.

Mouser Electronics

Authorized Distributor

Click to View Pricing, Inventory, Delivery & Lifecycle Information:

Omron:

[H3Y-2 AC100-120 10S](#) [H3Y-2 AC100-120 30S](#) [H3Y-2 AC100-120 5M](#) [H3Y-2 AC100-120 60S](#) [H3Y-2 AC200-230 10S](#) [H3Y-2 AC24 5S](#) [H3Y-2 DC24 10S](#) [H3Y-2 DC24 1S](#) [H3Y-2 DC24 5S](#) [H3Y-4 AC100-120 120S](#) [H3Y-4 AC100-120 1S](#) [H3Y-4 AC100-120 30S](#) [H3Y-4 AC100-120 5S](#) [H3Y-4 AC100-120 60S](#) [H3Y-4 AC200-230 30S](#) [H3Y-4 AC200-230 60S](#) [H3Y-4 DC24 1S](#) [H3Y-4 DC24 5S](#) [H3Y-2 DC12 5S](#) [H3Y-2 DC24 3H](#) [H3Y-4 DC24 5M](#) [H3Y-2 AC100-120 1S](#) [H3Y-2 AC100-120 5S](#) [H3Y-4 DC24 30S](#) [H3Y-4 DC24 60S](#) [H3Y-4-60S-AC120](#) [H3Y-21S-AC120](#)

Компания «Life Electronics» занимается поставками электронных компонентов импортного и отечественного производства от производителей и со складов крупных дистрибьюторов Европы, Америки и Азии.

С конца 2013 года компания активно расширяет линейку поставок компонентов по направлению коаксиальный кабель, кварцевые генераторы и конденсаторы (керамические, пленочные, электролитические), за счёт заключения дистрибьюторских договоров

Мы предлагаем:

- Конкурентоспособные цены и скидки постоянным клиентам.
- Специальные условия для постоянных клиентов.
- Подбор аналогов.
- Поставку компонентов в любых объемах, удовлетворяющих вашим потребностям.
- Приемлемые сроки поставки, возможна ускоренная поставка.
- Доставку товара в любую точку России и стран СНГ.
- Комплексную поставку.
- Работу по проектам и поставку образцов.
- Формирование склада под заказчика.
- Сертификаты соответствия на поставляемую продукцию (по желанию клиента).
- Тестирование поставляемой продукции.
- Поставку компонентов, требующих военную и космическую приемку.
- Входной контроль качества.
- Наличие сертификата ISO.

В составе нашей компании организован Конструкторский отдел, призванный помогать разработчикам, и инженерам.

Конструкторский отдел помогает осуществить:

- Регистрацию проекта у производителя компонентов.
- Техническую поддержку проекта.
- Защиту от снятия компонента с производства.
- Оценку стоимости проекта по компонентам.
- Изготовление тестовой платы монтаж и пусконаладочные работы.



Тел: +7 (812) 336 43 04 (многоканальный)

Email: org@lifeelectronics.ru