

# General Specifications

Toggles

Rockers

Pushbuttons

Illuminated PB

Programmable

Keylocks

Rotaries

Slides

Tactiles

Tilt

Touch

Indicators

Accessories

Supplement

## Electrical Capacity (Resistive Load)

<b>Power Level (silver):</b>	0.1A @ 30V DC
<b>Logic Level (gold):</b>	0.4VA maximum @ 28V AC/DC maximum (Applicable Range 0.1mA ~ 0.1A @ 20mV ~ 28V)

Note: Find additional explanation of operating range in Supplement section.

## Other Ratings

<b>Contact Resistance:</b>	20 milliohms maximum for power level; 40 milliohms maximum for logic level
<b>Insulation Resistance:</b>	100 megohms minimum @ 500V DC
<b>Dielectric Strength:</b>	500V AC minimum 1 minute minimum
<b>Mechanical Life:</b>	10,000 operations minimum
<b>Electrical Life:</b>	10,000 operations minimum
<b>Contact Timing:</b>	SS12S & SS22S – Shorting (make-before-break); SS14M – Nonshorting (break-before-make)
<b>Total Travel:</b>	.079" (2.0mm)

## Materials & Finishes

<b>Actuator:</b>	Polyamide
<b>Upper Case:</b>	Polyester for 3-On models; polyacetal for all other models
<b>Lower Case:</b>	Glass fiber reinforced polyester for 3-On models; glass fiber reinforced polybutylene terephthalate (thermoplastic) for other models
<b>Movable Contactor:</b>	Phosphor bronze with silver plating (code 2) or phosphor bronze with gold plating (code 4)
<b>Interior Base:</b>	Phenolic resin (thermoset)
<b>Terminals:</b>	Brass with silver plating over copper plating or brass with gold plating

## Environmental Data

<b>Operating Temp Range:</b>	-15°C through +60°C (+5°F through +140°F)
<b>Humidity:</b>	90 ~ 95% humidity for 96 hours @ 40°C (104°F)
<b>Vibration:</b>	10 ~ 55Hz with peak-to-peak amplitude of 1.5mm traversing the frequency range & returning in 1 minute; 3 right angled directions for 2 hours
<b>Shock:</b>	50G (490m/s <sup>2</sup> ) acceleration (tested in 6 right angled directions, with 5 shocks in each direction)

## PCB Processing

<b>Soldering:</b>	Wave Soldering: For non-supported through-hole, see Profile B in Supplement section. For supported through-hole, 5 seconds maximum @ 250°C maximum. Manual Solder: See Profile B in Supplement section.
<b>Cleaning:</b>	These devices are not process sealed. Hand clean locally using alcohol based solution.

## Standards & Certifications

The SS series devices have not been tested for UL recognition and CSA certification. These switches are designed for use in a low-voltage, low-current circuit. When used as intended in a low-voltage, low-current circuit, the results do not produce hazardous energy.

# Distinctive Characteristics

Top or side actuation permits flexible board design.

Compact dimensions and low profile allow high density mounting and close stacking of PC boards.

Crisp actuation positively indicates circuit status.

Double molded thermoset base and thermo-plastic housing prevent loosening of terminals due to high soldering temperatures.

Award-winning STC mechanism with benefits unavailable in conventional mechanisms: smoother, positive detent actuation, increased contact stability, and unparalleled logic-level reliability. (Additional STC details in Terms and Acronyms in the Supplement section.)

Insert molded terminals lock out flux, solvents, and other contaminants.

Inch or metric terminal spacing for standard PC board grid (.100" x .100" or 2.0mm x 2.0mm).

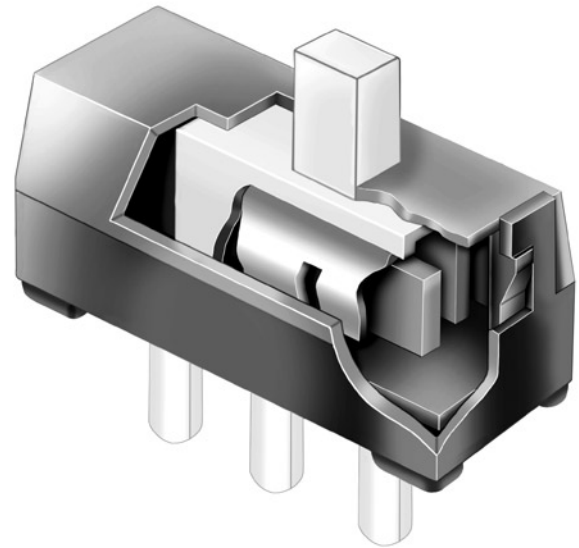

Actual Size

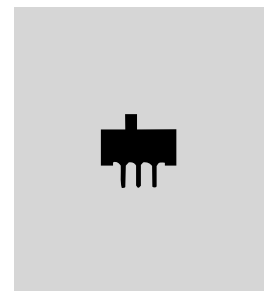

## TYPICAL SWITCH ORDERING EXAMPLE

SS

12S

D

P

2

### Poles & Circuits

<b>12S</b>	SPDT	ON	NONE	ON
SS12S model has shorting contacts.				
<b>* 14M</b>	SP3T	ON	ON	ON
SS14M model has nonshorting contacts.				
<b>22S</b>	DPDT	ON	NONE	ON
SS22S model has shorting contacts.				
See Poles & Circuits chart below.				
* 14M Circuit with silver contacts only.				

### Terminal Spacing

<b>B</b>	Metric 2.0mm x 2.0mm
<b>D</b>	Inch .100" x .100"

### Contact Material & Ratings

<b>2</b>	Silver Rated 0.1A @ 30V DC
<b>*4</b>	Gold Rated 0.4VA maximum @ 28V AC/DC maximum
* Gold not available with SS14M.	

### Actuation

<b>P</b>	Top Actuated
<b>H</b>	Side Actuated

### DESCRIPTION FOR TYPICAL ORDERING EXAMPLE

**SS12SDP2**

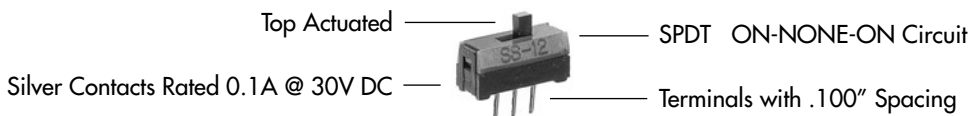

### POLES & CIRCUITS

Pole	Model	Slide Position			Connected Terminals			Throw & Schematics
		Right	Center	Left	Right	Center	Left	
SP	SS12S	ON	NONE	ON	2-1	NONE	2-3	SPDT Note: Terminal numbers are not actually on switch. 
SP	SS14M	ON	ON	ON	3-4	3-2	3-1	SP3T Make-Before-Break ON-OFF-ON circuit can be created by not connecting terminal 2. 
DP	SS22S	ON	NONE	ON	2-1 5-4	NONE	2-3 5-6	DPDT 

Toggles

Rockers

Pushbuttons

Illuminated PB

Programmable

Rotaries

Slides

Tactiles

Tilt

Touch

Indicators

Accessories

Supplement

TERMINAL SPACING

**B** Metric 2.0mm x 2.0mm with Black Base

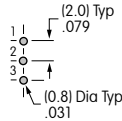
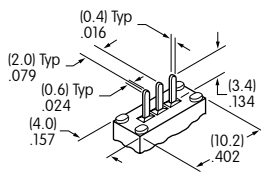

On-None-On Single Pole Models

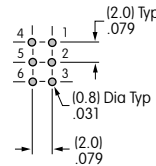
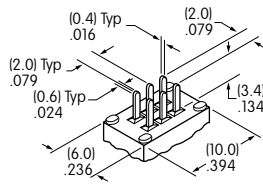

On-None-On Double Pole Models

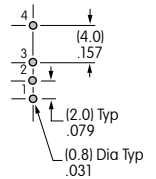
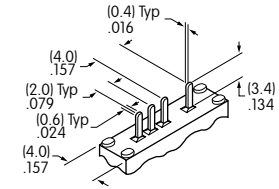

3-On Models

**D** Inch .100" x .100" with Gray Base

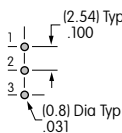
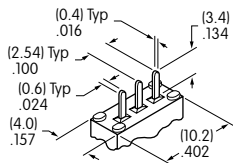

On-None-On Single Pole Models

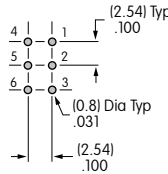
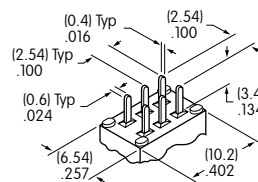

On-None-On Double Pole Models

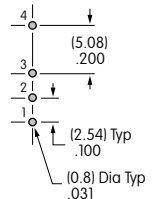
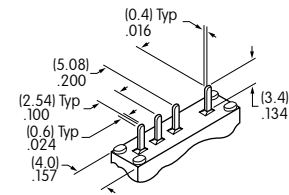

3-On Models

ACTUATION

**P** Top Actuated

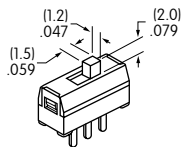

**H** Side Actuated

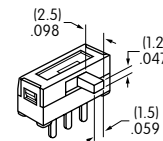

CONTACT MATERIALS & RATINGS

**2** Silver over Phosphor Bronze

Power Level

0.1A @ 30V DC

**4** Gold over Silver/Phosphor Bronze

Logic Level

0.4VA max @ 28V AC/DC max

Complete explanation of operating range in Supplement section.

## TYPICAL SWITCH DIMENSIONS

### Top Actuated

### Single & Double Pole

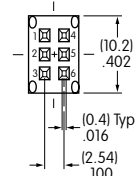
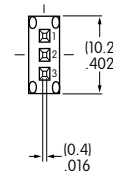
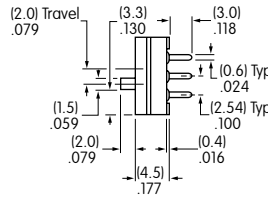
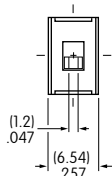
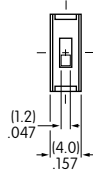

SS12SDP2

### Side Actuated

### Single & Double Pole

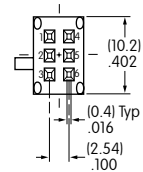
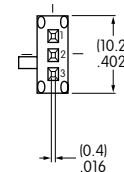
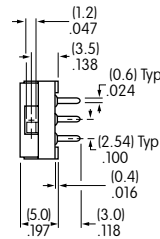
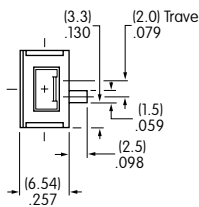
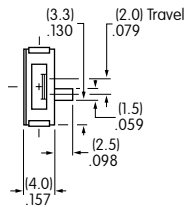

SS12SDH2

### 3-On Circuit • Top Actuated

### Single Pole

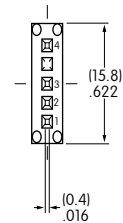
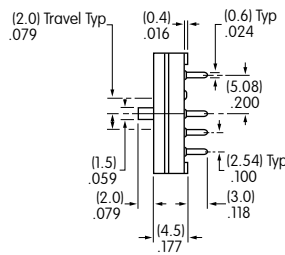
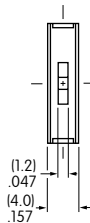

SS14MDP2

### 3-On Circuit • Side Actuated

### Single Pole

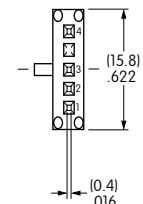
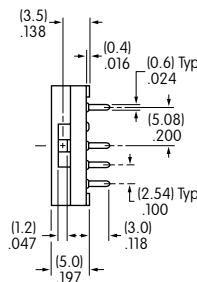
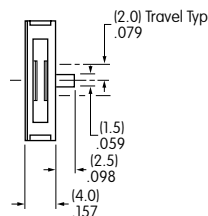

SS14MDH2

Компания «Life Electronics» занимается поставками электронных компонентов импортного и отечественного производства от производителей и со складов крупных дистрибьюторов Европы, Америки и Азии.

С конца 2013 года компания активно расширяет линейку поставок компонентов по направлению коаксиальный кабель, кварцевые генераторы и конденсаторы (керамические, пленочные, электролитические), за счёт заключения дистрибьюторских договоров

Мы предлагаем:

- Конкурентоспособные цены и скидки постоянным клиентам.
- Специальные условия для постоянных клиентов.
- Подбор аналогов.
- Поставку компонентов в любых объемах, удовлетворяющих вашим потребностям.
- Приемлемые сроки поставки, возможна ускоренная поставка.
- Доставку товара в любую точку России и стран СНГ.
- Комплексную поставку.
- Работу по проектам и поставку образцов.
- Формирование склада под заказчика.
- Сертификаты соответствия на поставляемую продукцию (по желанию клиента).
- Тестирование поставляемой продукции.
- Поставку компонентов, требующих военную и космическую приемку.
- Входной контроль качества.
- Наличие сертификата ISO.

В составе нашей компании организован Конструкторский отдел, призванный помогать разработчикам, и инженерам.

Конструкторский отдел помогает осуществить:

- Регистрацию проекта у производителя компонентов.
- Техническую поддержку проекта.
- Защиту от снятия компонента с производства.
- Оценку стоимости проекта по компонентам.
- Изготовление тестовой платы монтаж и пусконаладочные работы.



Тел: +7 (812) 336 43 04 (многоканальный)

Email: [org@lifeelectronics.ru](mailto:org@lifeelectronics.ru)