

Part Number*	Relay Description
KD00CK	5A Solid-State Relay (SSR)
KD02CK	5A SSR with Switch Status
KD20CK	5A SSR with Short-Circuit Protection
KD22CK	5A SSR with Short-Circuit Protection and Switch Status
LD00CM	10A Solid-State Relay
LD02CM	10A SSR with Switch Status
LD20CM	10A SSR with Short-Circuit Protection
LD22CM	10A SSR with Short-Circuit Protection and Switch Status

* The Y suffix denotes parameters tested to MIL-PRF-28750 specifications. The W suffix denotes parameters tested to Teledyne specifications.

ELECTRICAL SPECIFICATIONS

(-55°C TO +105°C UNLESS OTHERWISE NOTED)

INPUT (CONTROL) SPECIFICATION

When used in 2 terminal configuration

(TTL or direct control) (See Fig. 1)	Min	Typ	Max	Units
Input Current @ $V_{BIAS} = 5$ Vdc (See Fig. 2)			15	mAdc
Turn-Off Voltage (Guaranteed Off)			1.5	Vdc
Turn-On Voltage (Guaranteed On)	3.8			Vdc
Reverse Voltage Protection			-32	Vdc
Input Supply Range (See Note 1)	3.8		32	Vdc

INPUT (CONTROL) SPECIFICATION

When used in 3 terminal configuration

(CMOS or open collector TTL) (See Fig. 1)	Min	Typ	Max	Units
Control Current				
$V_{CONTROL} = 5$ Vdc			250	μ Adc
$V_{CONTROL} = 18$ Vdc			1	mAdc
Control Voltage Range	0		18	Vdc
Bias Supply Voltage (See Note 1)	3.8		32	Vdc
Bias Supply Current			16	mAdc
Turn-Off Voltage (Guaranteed Off)	3.2			Vdc
Turn-On Voltage (Guaranteed On)			0.3	Vdc

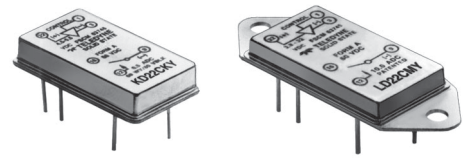

FEATURES

- Available with short-circuit/current overload protection
- Available with switch status output
- TTL and CMOS compatible control
- Low ON resistance power FET output
- Fast switching speed
- Meets 28 Vdc system requirements of MIL-STD-704
- Optical isolation
- Low profile hermetic package
- Built and tested to the requirements of MIL-PRF-28750

DESCRIPTION

The Series KD and LD solid-state relays are screened utilizing MIL-PRF-28750 test methods and are packaged in low profile hermetically sealed cases. These relays are constructed with state-of-the-art solid state techniques and feature fully floating power FET output technology. This allows the load to be connected to either output terminal and provides a low ON resistance. The input (control) and output are optically isolated to protect input logic circuits from output transients. Available options include short circuit and current overload protection, which provides complete protection for both the relay and system wiring. This feature not only provides protection should a short or overload occur while the relay is on, but will also provide protection should the relay be switched into a short. The second option is a status output line. Switch status returns the true status of the output switch and is optically isolated from the load. It provides status indication independent of the control circuit of the relay. The status line provides a logic 0 (low) when the relay output is off with load voltage and continuity present, and a logic 1 (high) when the output is on.

OUTPUT (LOAD) SPECIFICATIONS

(See Note 2)	Min	Typ	Max	Units
Continuous Load Current (See Fig. 3)				
KD and LD series without heat sink			5	A dc
LD series with heat sink			10	A dc
Leakage Current @ $V_{LOAD} = 60Vdc$				
KD00CK, KD20CK			100	μA
LD00CM, LD20CM			100	μA
KD02CK, KD22CK			2	mA
LD02CM, LD22CM			2	mA
Output Voltage Drop				
KD00CK, KD02CK			.60	V dc
KD20CK, KD22CK			.70	V dc
LD00CM, LD02CM @ 10A			1.2	V dc
LD20CM, LD22CM @ 10A			1.4	V dc
Continuous Operating Load Voltage				
			60	V dc
Transient Blocking Voltage @ 25°C				
			80	V dc
ON Resistance, $I_{LOAD} = 100 mA$, $T_J = 25^\circ C$, (See Note 3)				
KD00CK, KD02CK			.075	Ohm
LD00CM, LD20CM			.075	Ohm
KD20CK, KD22CK			.100	Ohm
LD20CM, LD22CM			.100	Ohm
Turn-On Time (See Fig. 5)				
			5	ms
Turn-Off Time (See Fig. 5)				
			2	ms
Electrical System Spike @ 25°C				
		± 600		Vpk
Output Capacitance at 25 Vdc, 100 KHz				
			1600	pF
Isolation (Input to Output)				
KD00CK, KD20CK			10	pF
LD00CM, LD20CM			10	pF
KD02CK, KD22CK			15	pF
LD02CM, LD22CM			15	pF
Dielectric Strength				
		1000		Vac
Insulation Resistance @ 500 Vdc				
		10^9		Ohms
Output Junction Temperature				
			130	°C
@ $I_{LOAD} = I_{max rated}$				
Maximum Junction Temperature				
			150	°C
Thermal Resistance Junction to Ambient (θ_{JA})				
			30	°C/W
Thermal Resistance Junction to Case (θ_{JC})				
			7	°C/W

BLOCK DIAGRAM

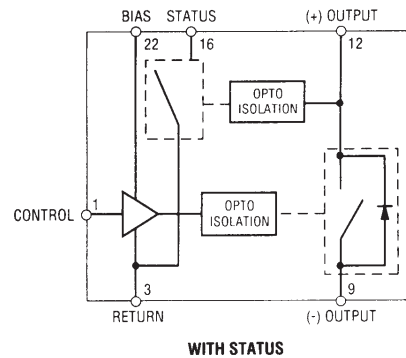

WITH STATUS

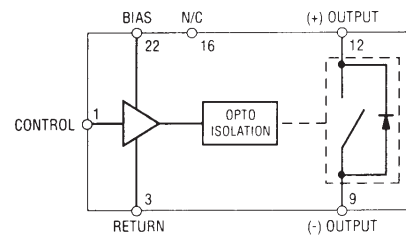

NO STATUS

MECHANICAL SPECIFICATION

DIMENSIONS ARE SHOWN IN INCHES (MILLIMETERS)

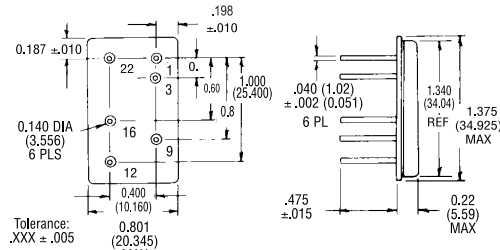

K PACKAGE

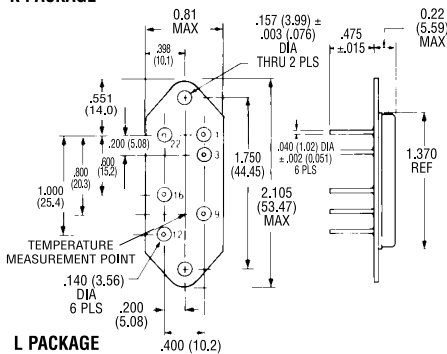

L PACKAGE

- Enclosure: Hermetically Sealed DIP
- Leak Rate: 1×10^{-8} CC/Sec Maximum
- Material: Header: Cold Rolled Steel
Nicksel Plated
Copper Core
Grade A Nicksel
- Pins: Nicksel Plated
Copper Core
Grade A Nicksel
- Can: Nicksel Plated
Copper Core
Grade A Nicksel
- Weight: 20 grams
- Tolerance: .XXX ± .005

ENVIRONMENTAL SPECIFICATIONS

	Min	Typ	Max	Units
Temperature Range				
Operating	-55		+105	°C
Storage	-55		+125	°C
Vibration 100 g	10		3000	Hz
Constant Acceleration			5000	g
Shock 0.5 ms pulse			1500	g

**STATUS OUTPUT TRUTH TABLE
(KD02CK, LD02CM, KD22CK, LD22CM)**

Control Voltage	Relay Output	State Status Output Level
High	Off	Low ($V_{SO} \leq 0.4 \text{ Vdc}$)
Low	On	High ($V_{SO} = V_{STATUS}$)

**STATUS OUTPUT SPECIFICATIONS
(KD02CK, LD02CM, KD22CK, LD22CM)**

	Min	Typ	Max	Units
Status Supply Voltage			30	Vdc
Status Leakage Current				
@16Vdc			10	µAdc
@30Vdc			100	µAdc
Status (sink) Current ($V_{SO} < 0.4 \text{ Vdc}$)			600	µAdc
Status Turn-On Time (See Fig. 6)			3.5	ms
Status Turn-Off Time (See Fig. 6)			8.0	ms

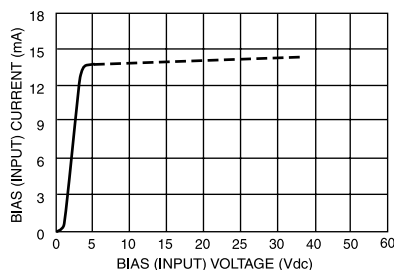

**BIAS (INPUT) CURRENT VS BIAS (INPUT) VOLTAGE
FIGURE 2 (See Note 1)**

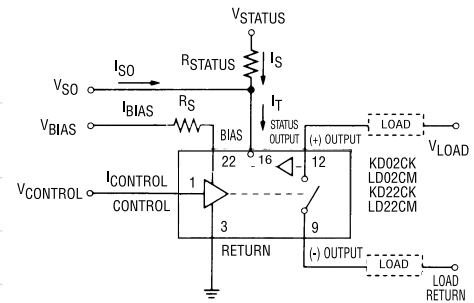

(A) 3 TERMINAL INPUT WITH STATUS (See Note 5)

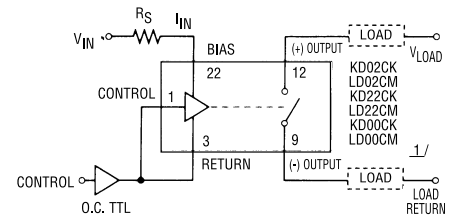

(B) 2 TERMINAL INPUT (OPEN COLLECTOR TTL DRIVE)

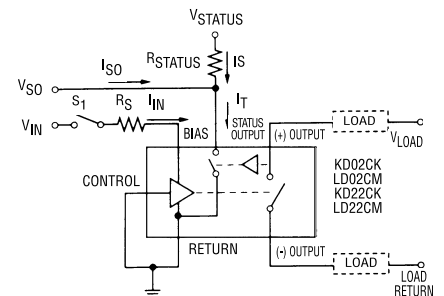

(C) 2 TERMINAL INPUT (DIRECT DRIVE) WITH STATUS

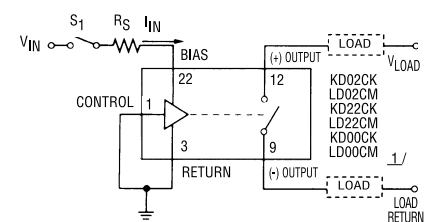

(D) 2 TERMINAL INPUT (DIRECT DRIVE)

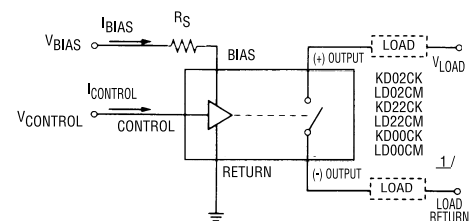

1/ KD02CK, KD22CK, LD02CM and LD22CM may be wired without the status line as shown in (B), (D) and (E) above.

(E) 3 TERMINAL INPUT WITHOUT STATUS

**WIRING CONFIGURATIONS
FIGURE 1 (See Note 1)**

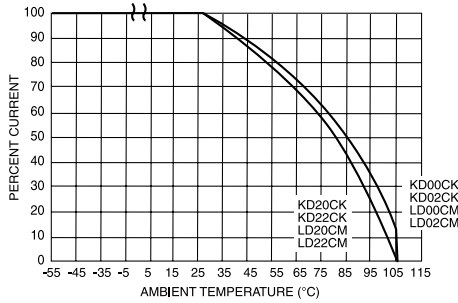

LOAD CURRENT DERATING CURVE FOR KD/LD SERIES WITHOUT A HEAT SINK
(A)

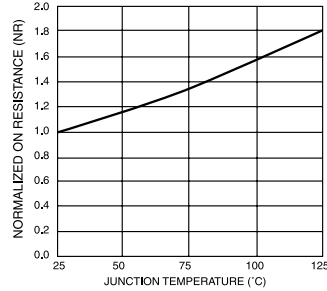

NORMALIZED ON RESISTANCE VS JUNCTION TEMPERATURE
FIGURE 4 (See Note 3)

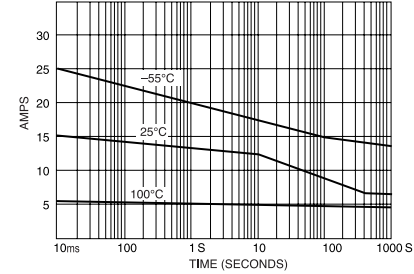

OVERLOAD CURRENT VS TIME TO TRIP (TYPICAL)
KD20CK, KD22CK, LD20CM, LD22CM
FIGURE 7

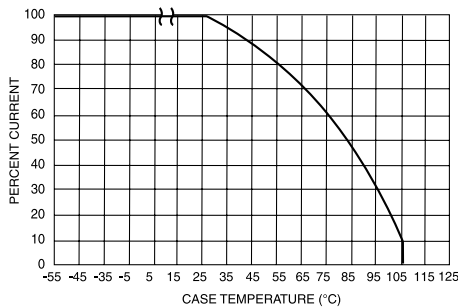

LOAD CURRENT DERATING CURVE FOR LD SERIES
(B)

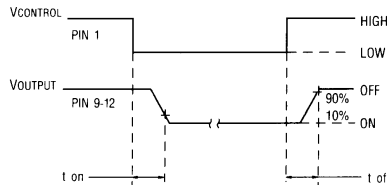

OUTPUT TURN-ON AND TURN-OFF TIMING
FIGURE 5

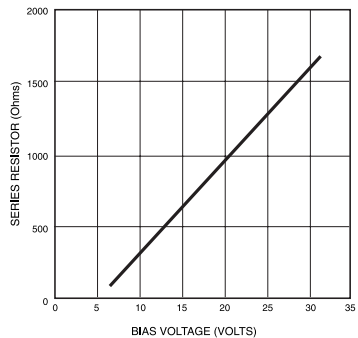

SERIES LIMIT BIAS RESISTOR VS BIAS VOLTAGE
FIGURE 8 (See Note 1)

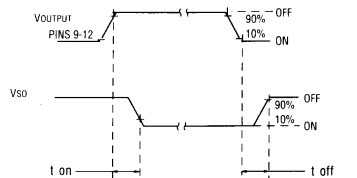

STATUS TURN-ON AND TURN-OFF TIMING
FIGURE 6

NOTES:

- Control input is compatible with CMOS or open collector TTL (with pull up resistor). For bias voltages above 6V, a series resistor is required. Use the standard resistor value equal to or less than the value found in Figure 8.
- The rated input voltage is 5V for all tests unless otherwise specified.
- To calculate the maximum ON resistance for a given junction temperature, find the normalized ON resistance factor (NR) from Figure 4. Calculate the new ON resistance as follows:

$$R_{(ON)} = NR \cdot R_{ON} @ 25^{\circ}C$$

$$R_{(ON)} = NR(R_{ON} @ +25^{\circ}C) + .025 \text{ ohm}$$
 (KD00CK, LD00CM, KD02CK, LD02CM)
 (KD20CK, LD20CM, KD22CK, LD22CM)
- Overload testing to the requirements of MIL-PRF-28750 is constrained to the limits imposed by the short circuit protection characteristics as defined in this specification. System series inductance for "shorted-load" mode of operation should be 50 μH. Maximum repetition rate into a shorted load should not exceed 10 Hz.
- A status pull up resistor is required for proper operation of the status output. Determine the current (I_{so}) required by the status interface. Calculate the current (I_s) through the status resistor such that the sink current through the status output is 0.6 mA. Select the status resistor such that it does not allow more than 0.6 mA to flow through the status output.

$$R_{STATUS} = \frac{V_{STATUS} - 0.4V}{I_{so}}$$

- Inductive loads should be diode suppressed. Input transitions should be ≤1 ms duration and the input drive should be a bounceless contact type.

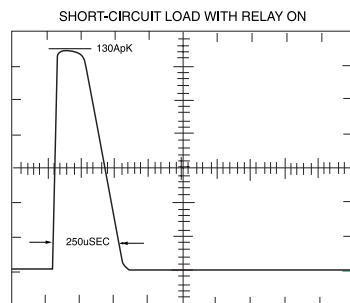
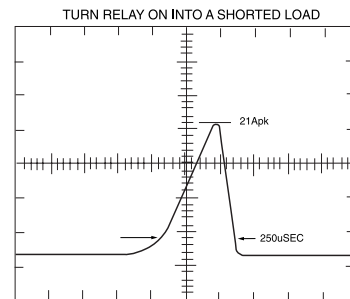

TYPICAL TRIP CURRENT CHARACTERISTICS FOR SHORT CIRCUIT CONDITIONS
FIGURE 9

Компания «Life Electronics» занимается поставками электронных компонентов импортного и отечественного производства от производителей и со складов крупных дистрибьюторов Европы, Америки и Азии.

С конца 2013 года компания активно расширяет линейку поставок компонентов по направлению коаксиальный кабель, кварцевые генераторы и конденсаторы (керамические, пленочные, электролитические), за счёт заключения дистрибьюторских договоров

Мы предлагаем:

- Конкурентоспособные цены и скидки постоянным клиентам.
- Специальные условия для постоянных клиентов.
- Подбор аналогов.
- Поставку компонентов в любых объемах, удовлетворяющих вашим потребностям.
- Приемлемые сроки поставки, возможна ускоренная поставка.
- Доставку товара в любую точку России и стран СНГ.
- Комплексную поставку.
- Работу по проектам и поставку образцов.
- Формирование склада под заказчика.
- Сертификаты соответствия на поставляемую продукцию (по желанию клиента).
- Тестирование поставляемой продукции.
- Поставку компонентов, требующих военную и космическую приемку.
- Входной контроль качества.
- Наличие сертификата ISO.

В составе нашей компании организован Конструкторский отдел, призванный помогать разработчикам, и инженерам.

Конструкторский отдел помогает осуществить:

- Регистрацию проекта у производителя компонентов.
- Техническую поддержку проекта.
- Защиту от снятия компонента с производства.
- Оценку стоимости проекта по компонентам.
- Изготовление тестовой платы монтаж и пусконаладочные работы.



Тел: +7 (812) 336 43 04 (многоканальный)

Email: org@lifeelectronics.ru