

## High Speed Infrared Emitting Diode, 940 nm, GaAlAs, MQW

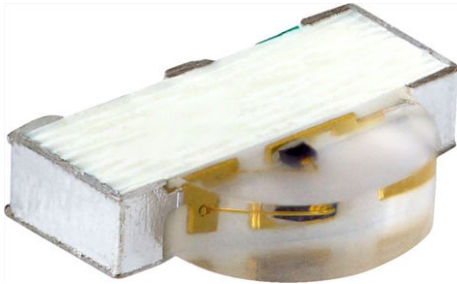

### DESCRIPTION

VSMB11940X01 is an infrared, 940 nm side looking emitting diode in GaAlAs multi quantum well (MQW) technology with high radiant power and high speed, molded in clear, untinted plastic package (with lens) for surface mounting (SMD).

### FEATURES

- Package type: Surface mount
- Package form: Side view
- Dimensions (L x W x H in mm): 3 x 2 x 0.6
- AEC-Q101 qualified
- Peak wavelength:  $\lambda_p = 940$  nm
- High reliability
- High radiant power
- High radiant intensity
- High speed
- Angle of half intensity:  $\phi = \pm 75^\circ$
- Low forward voltage
- Package matches with detector VEMD11940FX01
- Floor life: 168 h, MSL 3, acc. J-STD-020
- Lead (Pb)-free reflow soldering
- Material categorization: For definitions of compliance please see [www.vishay.com/doc?99912](http://www.vishay.com/doc?99912)

 AUTOMOTIVE  
GRADE

**RoHS**  
COMPLIANT  
HALOGEN  
**FREE**  
**GREEN**  
(5-2008)

### APPLICATIONS

- IR touch panel
- High power emitter for low space applications
- High performance transmissive or reflective sensors

### PRODUCT SUMMARY

COMPONENT	$I_e$ (mW/sr), 20 mA	$\phi$ (deg)	$\lambda_p$ (nm)	$t_r$ (ns)
VSMB11940X01	1	$\pm 75$	940	15

#### Note

- Test conditions see table "Basic Characteristics"

### ORDERING INFORMATION

ORDERING CODE	PACKAGING	REMARKS	PACKAGE FORM
VSMB11940X01	Tape and reel	MOQ: 4000 pcs, 4000 pcs/reel	side view

#### Note

- MOQ: minimum order quantity

### ABSOLUTE MAXIMUM RATINGS ( $T_{amb} = 25^\circ\text{C}$ , unless otherwise specified)

PARAMETER	TEST CONDITION	SYMBOL	VALUE	UNIT
Reverse voltage		$V_R$	5	V
Forward current		$I_F$	65	mA
Peak forward current	$t_p/T = 0.5$ , $t_p = 100 \mu\text{s}$	$I_{FM}$	130	mA
Surge forward current	$t_p = 100 \mu\text{s}$	$I_{FSM}$	500	mA
Power dissipation		$P_V$	104	mW
Junction temperature		$T_j$	100	$^\circ\text{C}$
Operating temperature range		$T_{amb}$	-40 to +85	$^\circ\text{C}$
Storage temperature range		$T_{stg}$	-40 to +100	$^\circ\text{C}$
Soldering temperature	according to fig. 9, J-STD-020	$T_{sd}$	580	$^\circ\text{C}$
Thermal resistance junction/ambient	J-STD-051, leads 7 mm, soldered on PCB	$R_{thJA}$	450	K/W

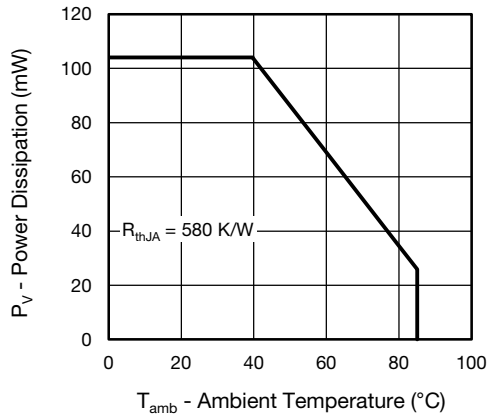

Fig. 1 - Power Dissipation Limit vs. Ambient Temperature

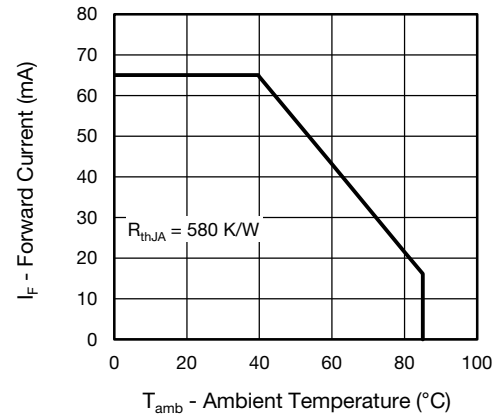

Fig. 2 - Forward Current Limit vs. Ambient Temperature

<b>BASIC CHARACTERISTICS</b> ( $T_{amb} = 25\text{ }^{\circ}\text{C}$ , unless otherwise specified)						
PARAMETER	TEST CONDITION	SYMBOL	MIN.	TYP.	MAX.	UNIT
Forward voltage	$I_F = 20\text{ mA}$ , $t_p = 20\text{ ms}$	$V_F$	1.1	1.24	1.5	V
	$I_F = 65\text{ mA}$ , $t_p = 20\text{ ms}$	$V_F$		1.35		V
	$I_F = 500\text{ mA}$ , $t_p = 100\text{ }\mu\text{s}$	$V_F$		1.8		V
Temperature coefficient of $V_F$	$I_F = 1\text{ mA}$	$TK_{V_F}$		-1.5		mV/K
Reverse current	$V_R = 5\text{ V}$	$I_R$			10	$\mu\text{A}$
Junction capacitance	$V_R = 0\text{ V}$ , $f = 1\text{ MHz}$ , $E = 0\text{ mW/cm}^2$	$C_J$		21		pF
Radiant intensity	$I_F = 20\text{ mA}$ , $t_p = 20\text{ ms}$	$I_e$	0.5	1.0	1.5	mW/sr
	$I_F = 65\text{ mA}$ , $t_p = 20\text{ ms}$	$I_e$		3.2		mW/sr
	$I_F = 500\text{ mA}$ , $t_p = 100\text{ }\mu\text{s}$	$I_e$		20		mW/sr
Radiant power	$I_F = 100\text{ mA}$ , $t_p = 20\text{ ms}$	$\phi_e$		35		mW
Temperature coefficient of radiant power	$I_F = 100\text{ mA}$	$TK_{\phi_e}$		-0.47		%/K
Angle of half intensity - horizontal		$\phi_h$		$\pm 77.5$		deg
Angle of half intensity - vertical		$\phi_v$		$\pm 72.5$		deg
Peak wavelength	$I_F = 30\text{ mA}$	$\lambda_p$		940		nm
Spectral bandwidth	$I_F = 30\text{ mA}$	$\Delta\lambda$		25		nm
Temperature coefficient of $\lambda_p$	$I_F = 30\text{ mA}$	$TK_{\lambda_p}$		0.3		nm
Rise time	$I_F = 100\text{ mA}$ , 20 % to 80 %	$t_r$		15		ns
Fall time	$I_F = 100\text{ mA}$ , 20 % to 80 %	$t_f$		15		ns

**BASIC CHARACTERISTICS** ( $T_{amb} = 25\text{ }^{\circ}\text{C}$ , unless otherwise specified)

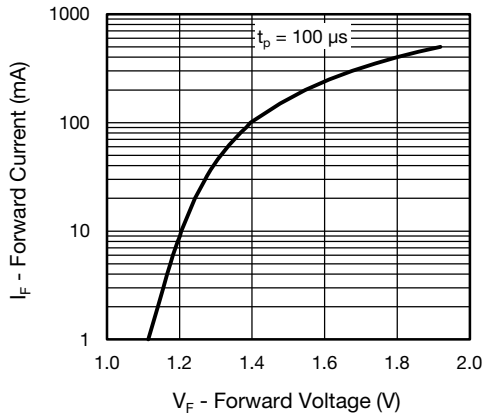

Fig. 3 - Forward Current vs. Forward Voltage

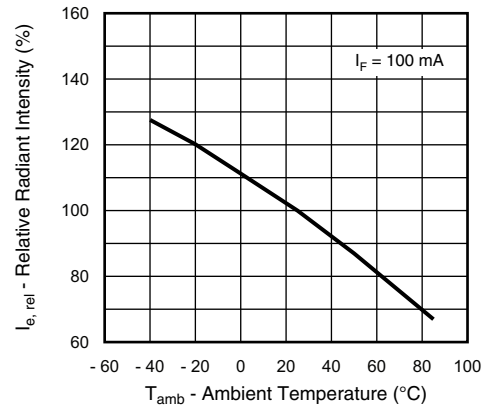

Fig. 6 - Relative Radiant Intensity vs. Ambient Temperature

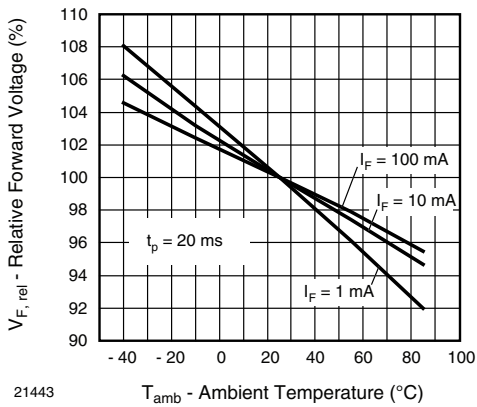

Fig. 4 - Relative Forward Voltage vs. Ambient Temperature

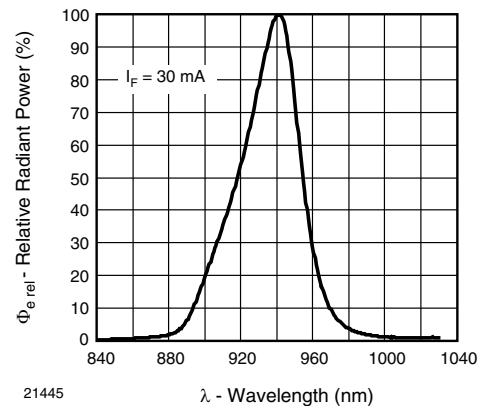

Fig. 7 - Relative Radiant Power vs. Wavelength

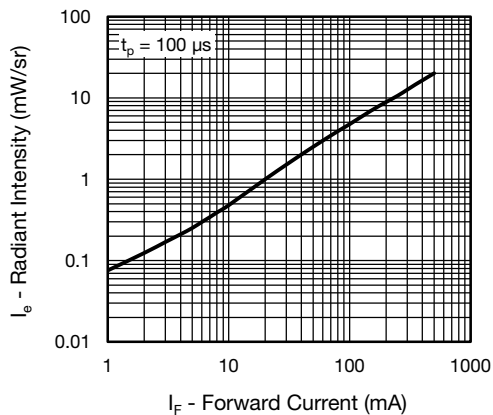

Fig. 5 - Radiant Intensity vs. Forward Current

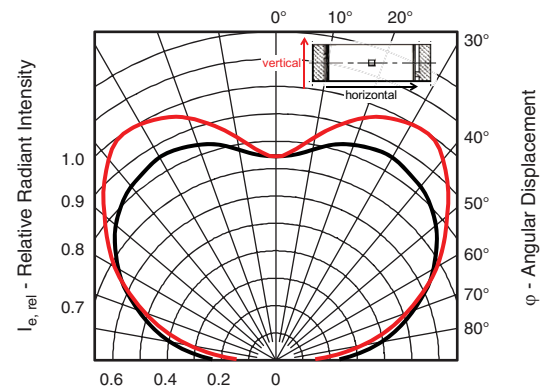

Fig. 8 - Relative Radiant Intensity vs. Angular Displacement

**REFLOW SOLDER PROFILE**



Fig. 9 - Lead (Pb)-free Reflow Solder Profile acc. J-STD-020

**DRYPACK**

Devices are packed in moisture barrier bags (MBB) to prevent the products from moisture absorption during transportation and storage. Each bag contains a desiccant.

**FLOOR LIFE**

Time between soldering and removing from MBB must not exceed the time indicated in J-STD-020:

Moisture sensitivity: level 3

Floor life: 168 h

Conditions:  $T_{amb} < 30\text{ }^{\circ}\text{C}$ ,  $\text{RH} < 60\text{ } \%$

**DRYING**

In case of moisture absorption devices should be baked before soldering. Conditions see J-STD-020 or label. Devices taped on reel dry using recommended conditions 192 h at  $40\text{ }^{\circ}\text{C}$  ( $+ 5\text{ }^{\circ}\text{C}$ ),  $\text{RH} < 5\text{ } \%$ .

**PACKAGE DIMENSIONS** in millimeters

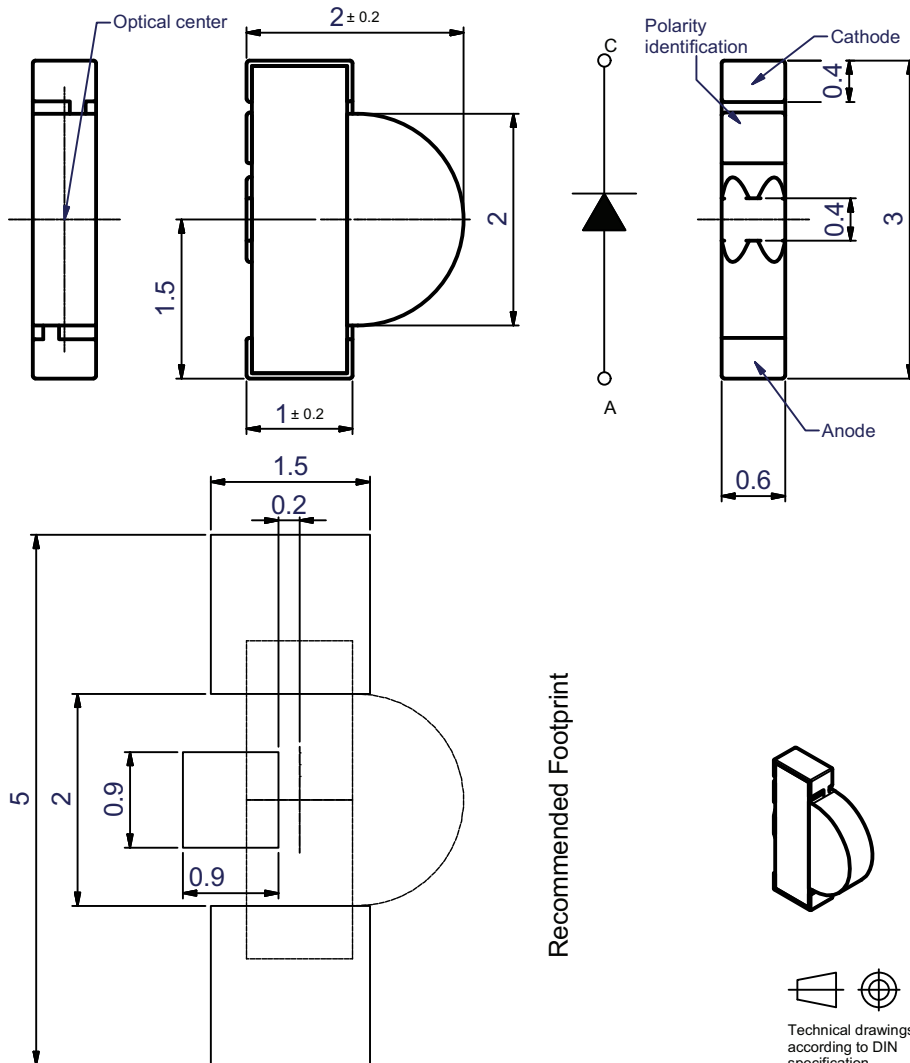

Drawing- No: 6.550-5327.01-4  
Issue: Prel. 26.11.2013

Recommended Footprint

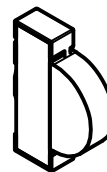

Technical drawings according to DIN specification.

Not indicated tolerances  $\pm 0.1\text{ mm}$

**TAPING AND REEL DIMENSIONS** in millimeters

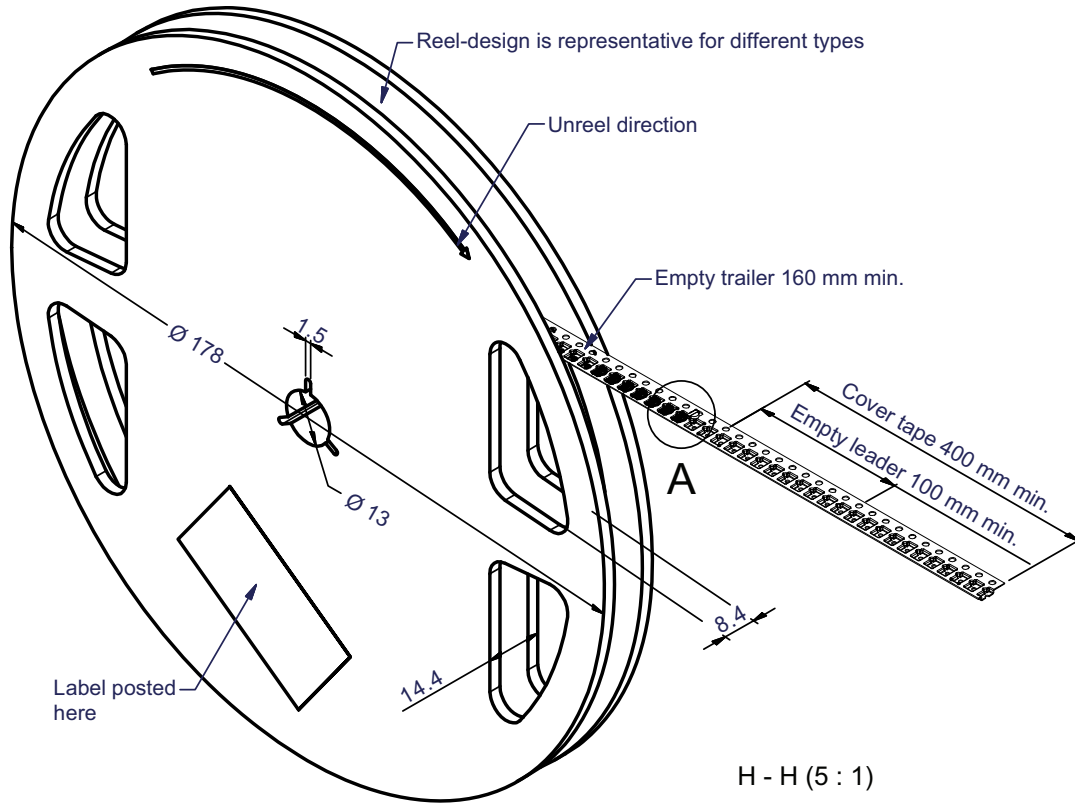

Label posted here

H - H (5 : 1)

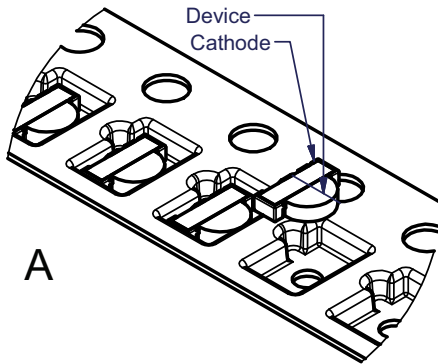

Drawing refers to following types: VSMB11940  
VEMD11940F

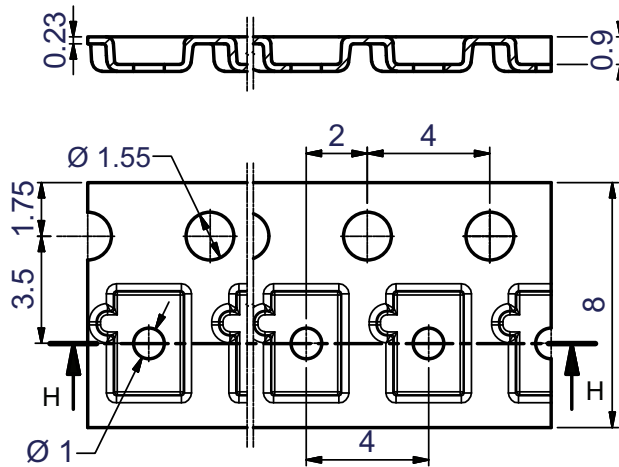

Drawing No. 9.800-5126.01-4; Issue: Prel. 23.05.2013



## Disclaimer

ALL PRODUCT, PRODUCT SPECIFICATIONS AND DATA ARE SUBJECT TO CHANGE WITHOUT NOTICE TO IMPROVE RELIABILITY, FUNCTION OR DESIGN OR OTHERWISE.

Vishay Intertechnology, Inc., its affiliates, agents, and employees, and all persons acting on its or their behalf (collectively, "Vishay"), disclaim any and all liability for any errors, inaccuracies or incompleteness contained in any datasheet or in any other disclosure relating to any product.

Vishay makes no warranty, representation or guarantee regarding the suitability of the products for any particular purpose or the continuing production of any product. To the maximum extent permitted by applicable law, Vishay disclaims (i) any and all liability arising out of the application or use of any product, (ii) any and all liability, including without limitation special, consequential or incidental damages, and (iii) any and all implied warranties, including warranties of fitness for particular purpose, non-infringement and merchantability.

Statements regarding the suitability of products for certain types of applications are based on Vishay's knowledge of typical requirements that are often placed on Vishay products in generic applications. Such statements are not binding statements about the suitability of products for a particular application. It is the customer's responsibility to validate that a particular product with the properties described in the product specification is suitable for use in a particular application. Parameters provided in datasheets and/or specifications may vary in different applications and performance may vary over time. All operating parameters, including typical parameters, must be validated for each customer application by the customer's technical experts. Product specifications do not expand or otherwise modify Vishay's terms and conditions of purchase, including but not limited to the warranty expressed therein.

Except as expressly indicated in writing, Vishay products are not designed for use in medical, life-saving, or life-sustaining applications or for any other application in which the failure of the Vishay product could result in personal injury or death. Customers using or selling Vishay products not expressly indicated for use in such applications do so at their own risk. Please contact authorized Vishay personnel to obtain written terms and conditions regarding products designed for such applications.

No license, express or implied, by estoppel or otherwise, to any intellectual property rights is granted by this document or by any conduct of Vishay. Product names and markings noted herein may be trademarks of their respective owners.

## Material Category Policy

**Vishay Intertechnology, Inc. hereby certifies that all its products that are identified as RoHS-Compliant fulfill the definitions and restrictions defined under Directive 2011/65/EU of The European Parliament and of the Council of June 8, 2011 on the restriction of the use of certain hazardous substances in electrical and electronic equipment (EEE) - recast, unless otherwise specified as non-compliant.**

**Please note that some Vishay documentation may still make reference to RoHS Directive 2002/95/EC. We confirm that all the products identified as being compliant to Directive 2002/95/EC conform to Directive 2011/65/EU.**

**Vishay Intertechnology, Inc. hereby certifies that all its products that are identified as Halogen-Free follow Halogen-Free requirements as per JEDEC JS709A standards. Please note that some Vishay documentation may still make reference to the IEC 61249-2-21 definition. We confirm that all the products identified as being compliant to IEC 61249-2-21 conform to JEDEC JS709A standards.**

Компания «Life Electronics» занимается поставками электронных компонентов импортного и отечественного производства от производителей и со складов крупных дистрибьюторов Европы, Америки и Азии.

С конца 2013 года компания активно расширяет линейку поставок компонентов по направлению коаксиальный кабель, кварцевые генераторы и конденсаторы (керамические, пленочные, электролитические), за счёт заключения дистрибьюторских договоров

Мы предлагаем:

- Конкурентоспособные цены и скидки постоянным клиентам.
- Специальные условия для постоянных клиентов.
- Подбор аналогов.
- Поставку компонентов в любых объемах, удовлетворяющих вашим потребностям.
- Приемлемые сроки поставки, возможна ускоренная поставка.
- Доставку товара в любую точку России и стран СНГ.
- Комплексную поставку.
- Работу по проектам и поставку образцов.
- Формирование склада под заказчика.
- Сертификаты соответствия на поставляемую продукцию (по желанию клиента).
- Тестирование поставляемой продукции.
- Поставку компонентов, требующих военную и космическую приемку.
- Входной контроль качества.
- Наличие сертификата ISO.

В составе нашей компании организован Конструкторский отдел, призванный помогать разработчикам, и инженерам.

Конструкторский отдел помогает осуществить:

- Регистрацию проекта у производителя компонентов.
- Техническую поддержку проекта.
- Защиту от снятия компонента с производства.
- Оценку стоимости проекта по компонентам.
- Изготовление тестовой платы монтаж и пусконаладочные работы.



Тел: +7 (812) 336 43 04 (многоканальный)

Email: [org@lifeelectronics.ru](mailto:org@lifeelectronics.ru)