

EAO – Your Expert Partner for
Human Machine Interfaces



EAO Product Information

Series 84



| | |
|-------------------------------|----|
| Description | 3 |
| Product Assembly | 4 |
| Mounting instruction | 6 |
| Devices raised mounting | 7 |
| Devices flush mounting | 9 |
| Accessories..... | 13 |
| Technical Data..... | 27 |
| Application guidelines..... | 30 |
| Drawings..... | 31 |
| Index..... | 45 |

Product Information

General notes

The Series 84 consists of indicators, pushbuttons and emergency-stop switches. The indicators and pushbuttons are a modular system of lens, actuator, switching element and a variety of means of connection and mounting. Different front protection of IP 67, IP 65 or IP 40 ensure that the pushbuttons are suited for industrial use.

Anodized aluminium parts can have visible variations due production-technical reasons.

Mounting

The actuators of the Series 84 are inserted in a 22.5 mm diameter mounting hole and the switching units are clipped on to the rear of the actuators. The pushbutton system can be mounted as a complete unit (actuator and switching unit). Mounting from the front with the wiring already attached is also possible.

When mounted on printed circuit boards the actuators are inserted in the mounting hole 22.5 mm dia. and the switching elements are fixed on the board. The printed circuit board is connected to the preassembled actuator by means of the mounting flange. There is no need for subsequent adjustment or spacing studs.

Lenses

The lenses are available in various colours and made either from plastic or anodized aluminium.

Marking

The marking plates of the Series 84 can be marked by engraving or hot stamping.

Specific symbols and markings are available on request.

The lenses are without holder not engravable, since by mounting no accurate position of the engraving text is reached.

Illumination

To ensure full illumination, the switching elements can be supplied with integrated single LEDs in the colours red, orange, yellow, green, blue or white. The series resistor is integrated.

Luminosity and wave length scattering caused by the technology used in the LED manufacturing processes may lead to visual differences in our products.

Emergency-stop pushbutton, foolproof

The E-stop pushbutton can be mounted in front panels with a thickness between 1 and 4 mm. It has a low behind-panel depth of 13.5 mm (max.) respectively 18.5 mm with plug-in terminlas and can be safely and easily adapted to PCBs of different heights. The front protection degree is IP 65.

Importantly, the Series 84 emergency-stop requires no additional assembly because of its single-piece 'monoblock' design.

The switch's status is clearly indicated by a black or green colour ring on the shaft, and the foolproof actuator design conforms to DIN EN ISO 13850 and EN IEC 60947.

It can be supplied with LED illumination that is visible even from the side.

Specimen order

Indicator :

- Indicator actuator, IP67 84-0100.0

Essential accessories :

- Lens plastic blue 84-7111.600
 - Illumination element 84-8001.6620
 Single-LED blue 24VDC, plug-in terminal

or

Indicator with PCB terminal :

- Indicator actuator, IP67 84-3100.1

Essential accessories :

- Lens plastic red 84-7111.200
 - Illumination element with PCB terminal 92-800.042
 - Single-LED red 2.1VDC 10-2602.3202L
 - Mounting flange 92-960.0

*We reserve the right to modify technical data
 All dimensions in mm*

Indicator and pushbutton illuminative, 25 mm dia.

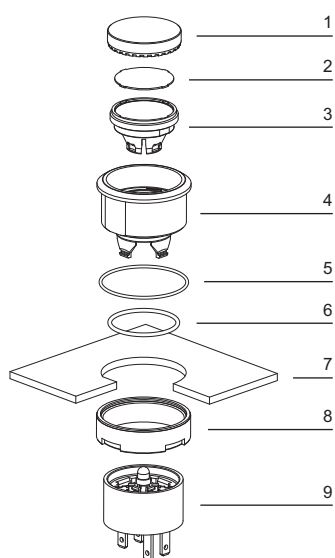

- 1 Lens
- 2 Marking plate
- 3 Lens holder
- 4 Actuator housing
- 5 Outer sealing
- 6 Inner sealing
- 7 Front panel
- 8 Fixing nut
- 9 Switching-/Illumination element with plug-in terminal (solderable)

Indicator and pushbutton illuminative, 40 mm dia.



- 1 Lens
- 2 Marking plate
- 3 Lens holder
- 4 Actuator housing
- 5 Sealing
- 6 Front panel
- 7 Fixing nut
- 8 Switching-/Illumination element with flat ribbon cable

Indicator and pushbutton illuminative, 25 mm dia., PCB version



- 1 Lens
- 2 Marking plate
- 3 Lens holder
- 4 Actuator housing
- 5 Sealing
- 6 Front panel
- 7 Fixing nut
- 8 Mounting flange
- 9 Switching-/Illumination element with PCB terminal
- 10 PCB
- 11 Fixing screws

Emergency-stop pushbutton



- 1 Emergency-stop pushbutton
- 2 Fixing nut
- 3 Position indication ring green or black

Arrangement mounting flange for switching- and illumination element, PCB mounting



The arrangement of the mounting flanges and their number is determined by the size of the front panel or PCB. To ensure uniform, tactile switching, we recommend a layout of the flanges as per adjacent sketch.

For large PCBs with several switching elements we recommend the following procedure :

1. Fit the actuator to the front panel.
2. Clip the mounting flange to the rear of the intended actuator.
3. Screw the PCB with the components soldered to it to the assembled mounting flange.

This arrangement applies to PCBs 1.6 mm thick.

Dismantling mounting flange

The tool 84-998 must be used for removing the mounting flange from the actuator. Before removing the flange, the PCB fixing screws must be loosened.

Emergency-stop pushbutton, foolproof EN IEC 60947-5-5, complete

Application as per DIN EN ISO 13850 and EN 60204-1



| | Front protection | Switching action | Mushroom had cap | Illumination | Terminals | Contacts | Ø 32 mm Typ-Nr. | Component layout | Mounting dimensions | Technical drawing | Circuit drawing | |
|--|------------------|------------------|------------------|--------------|-----------|-------------|---------------------|------------------|---------------------|-------------------|-----------------|-------|
| Emergency-stop pushbutton, foolproof EN IEC 60947-5-5, complete Position indication ring black Twist to unlock clockwise | IP 65 | MA | Plastic red | without | FR | 1 NC | 84-5020.0040 | 2 | 2 | 17 | 8 | 0.036 |
| | | | | | | 1 NC + 1 NO | 84-5030.0040 | 2 | 2 | 17 | 9 | 0.036 |
| | | | | | | 2 NC | 84-5040.0040 | 2 | 2 | 17 | 10 | 0.036 |
| | | | | | PT 2.8 s | 1 NC | 84-5020.0020 | 1 | 2 | 17 | 8 | 0.028 |
| | | | | | | 1 NC + 1 NO | 84-5030.0020 | 1 | 2 | 17 | 9 | 0.028 |
| | | | | | | 2 NC | 84-5040.0020 | 1 | 2 | 17 | 10 | 0.028 |
| Position indication ring black Twist to unlock clockwise LED operating voltage: 5 ... 30 VDC Current consumption: 9.7 ... 12.4 mA | IP 65 | MA | Plastic red | LED red | FR | 1 NC | 84-5021.2B40 | 2 | 2 | 17 | 11 | 0.036 |
| | | | | | | 1 NC + 1 NO | 84-5031.2B40 | 2 | 2 | 17 | 12 | 0.036 |
| | | | | | | 2 NC | 84-5041.2B40 | 2 | 2 | 17 | 13 | 0.036 |
| | | | | | PT 2.8 s | 1 NC | 84-5021.2B20 | 1 | 2 | 17 | 11 | 0.028 |
| | | | | | | 1 NC + 1 NO | 84-5031.2B20 | 1 | 2 | 17 | 12 | 0.028 |
| | | | | | | 2 NC | 84-5041.2B20 | 1 | 2 | 17 | 13 | 0.028 |
| Position indication ring green Twist to unlock clockwise | IP 65 | MA | Plastic red | without | FR | 1 NC | 84-5120.0040 | 2 | 2 | 17 | 8 | 0.036 |
| | | | | | | 1 NC + 1 NO | 84-5130.0040 | 2 | 2 | 17 | 9 | 0.036 |
| | | | | | | 2 NC | 84-5140.0040 | 2 | 2 | 17 | 10 | 0.036 |
| | | | | | PT 2.8 s | 1 NC | 84-5120.0020 | 1 | 2 | 17 | 8 | 0.028 |
| | | | | | | 1 NC + 1 NO | 84-5130.0020 | 1 | 2 | 17 | 9 | 0.028 |
| | | | | | | 2 NC | 84-5140.0020 | 1 | 2 | 17 | 10 | 0.028 |
| Position indication ring green Twist to unlock clockwise LED operating voltage: 5 ... 30 VDC Current consumption: 9.7 ... 12.4 mA | IP 65 | MA | Plastic red | LED red | FR | 1 NC | 84-5121.2B40 | 2 | 2 | 17 | 11 | 0.036 |
| | | | | | | 1 NC + 1 NO | 84-5131.2B40 | 2 | 2 | 17 | 12 | 0.036 |
| | | | | | | 2 NC | 84-5141.2B40 | 2 | 2 | 17 | 13 | 0.036 |
| | | | | | PT 2.8 s | 1 NC | 84-5121.2B20 | 1 | 2 | 17 | 10 | 0.028 |
| | | | | | | 1 NC + 1 NO | 84-5131.2B20 | 1 | 2 | 17 | 12 | 0.028 |
| | | | | | | 2 NC | 84-5141.2B20 | 1 | 2 | 17 | 13 | 0.028 |

Standard version:

Flat ribbon-cable length 300 mm; Plug-in terminal 2.8 x 0.5 mm.

Other options on request:

Customisation of flat ribbon-cable and connectors.

Switching action: MA = Maintained action

Terminals: FR = Flat ribbon cable, PT 2.8 s = Plug-in terminal 2.8 mm (solderable)

Contacts: NC = Normally closed, NO = Normally open

Component layout from page 31, Mounting dimensions from page 34, Technical drawing from page 35, Circuit drawing from page 43

Stop pushbutton grey, complete



| | Front protection | Switching action | Mushroom had cap | Illumination | Terminals | Contacts | Ø 32 mm Typ-Nr. | Component layout | Mounting dimensions | Technical drawing | Circuit drawing | |
|--|------------------|------------------|------------------|--------------|-----------|-------------|---------------------|------------------|---------------------|-------------------|-----------------|-------|
| Stop pushbutton grey, complete Position indication ring black Twist to unlock clockwise | IP 65 | MA | Plastic grey | without | FR | 1 NC | 84-6820.0040 | 2 | 2 | 17 | 8 | 0.036 |
| | | | | | | 1 NC + 1 NO | 84-6830.0040 | 2 | 2 | 17 | 9 | 0.036 |
| | | | | | | 2 NC | 84-6840.0040 | 2 | 2 | 17 | 10 | 0.036 |
| | | | | | PT 2.8 s | 1 NC | 84-6820.0020 | 1 | 2 | 17 | 8 | 0.028 |
| | | | | | | 1 NC + 1 NO | 84-6830.0020 | 1 | 2 | 17 | 9 | 0.028 |
| | | | | | | 2 NC | 84-6840.0020 | 1 | 2 | 17 | 10 | 0.028 |
| Position indication ring black Twist to unlock clockwise LED operating voltage: 5 ... 30 VDC Current consumption: 9.7 ... 12.4 mA | IP 65 | MA | Plastic grey | LED red | FR | 1 NC | 84-6821.2B40 | 2 | 2 | 17 | 11 | 0.036 |
| | | | | | | 1 NC + 1 NO | 84-6831.2B40 | 2 | 2 | 17 | 12 | 0.036 |
| | | | | | | 2 NC | 84-6841.2B40 | 2 | 2 | 17 | 13 | 0.036 |
| | | | | | PT 2.8 s | 1 NC | 84-6821.2B20 | 1 | 2 | 17 | 11 | 0.028 |
| | | | | | | 1 NC + 1 NO | 84-6831.2B20 | 1 | 2 | 17 | 12 | 0.028 |
| | | | | | | 2 NC | 84-6841.2B20 | 1 | 2 | 17 | 13 | 0.028 |

Standard version:

Flat ribbon-cable length 300 mm; Plug-in terminal 2.8 x 0.5 mm.

Other options on request:

Customisation of flat ribbon-cable and connectors.

Switching action: MA = Maintained action

Terminals: FR = Flat ribbon cable, PT 2.8 s = Plug-in terminal 2.8 mm (solderable)

Contacts: NC = Normally closed, NO = Normally open

Component layout from page 31, Mounting dimensions from page 34, Technical drawing from page 35, Circuit drawing from page 43

Indicator actuator

Illuminated lens, non-illuminated bezel



Essential Accessories:

-  Illumination element page 17
-  Lens plastic page 13

| | Front protection | Front ring | Ø 25 mm Typ-Nr. | Mounting dimensions | Technical drawing | |
|---------------------------|------------------|-------------------|--------------------|---------------------|-------------------|-------|
| Indicator actuator | IP 40 | Plastic black | 84-3100.0 | 1 | 16 | 0.004 |
| | IP 67 | Aluminium natural | 84-0200.7 | 1 | 16 | 0.008 |
| | | Plastic black | 84-0100.0 | 1 | 16 | 0.003 |



Mounting dimensions from page 34, Technical drawing from page 35

Illuminated pushbutton actuator

Illuminated lens, non-illuminated bezel



Essential Accessories:

-  Lens plastic page 13
-  Switching element illuminated page 19

| | Switching action | Front protection | Front ring | Ø 40 mm Typ-Nr. | Ø 25 mm Typ-Nr. | Mounting dimensions | Technical drawing | Circuit drawing | |
|--|------------------|-----------------------|-------------------|--------------------|--------------------|---------------------|-------------------|-----------------|-------|
| Illuminated pushbutton actuator | M | IP 67 | Aluminium natural | 84-1221.7 | | 3 | 18 | 4 | 0.022 |
| | | IP 40 | Plastic black | | 84-2101.0 | 1 | 16 | 4 | 0.004 |
| | IP 67 | Aluminium black | | 84-1201.0 | 1 | 16 | 4 | 0.008 | |
| | | Aluminium blue | | 84-1201.6 | 1 | 16 | 4 | 0.008 | |
| | | Aluminium gold | | 84-1201.4 | 1 | 16 | 4 | 0.008 | |
| | | Aluminium natural | | 84-1201.7 | 1 | 16 | 4 | 0.008 | |
| | | Aluminium olive-green | | 84-1201.5 | 1 | 16 | 4 | 0.008 | |
| | | Aluminium red | | 84-1201.2 | 1 | 16 | 4 | 0.008 | |
| | | Plastic black | | 84-1101.0 | 1 | 16 | 4 | 0.003 | |

Switching action: M = Momentary action



Mounting dimensions from page 34, Technical drawing from page 35, Circuit drawing from page 43

Pushbutton actuator

Non-illuminated lens and bezel



Essential Accessories:

-  Lens metal page 14
-  Switching element non-illuminated page 20

| | Front protection | Switching action | Front ring | Ø 40 mm Typ-Nr. | Ø 25 mm Typ-Nr. | Mounting dimensions | Technical drawing | Circuit drawing |  |
|----------------------------|------------------|------------------|-----------------------|--------------------|--------------------|---------------------|-------------------|-----------------|---|
| Pushbutton actuator | IP 67 | M | Aluminium natural | 84-1221.7 | | 3 | 18 | 4 | 0.022 |
| | IP 40 | M | Plastic black | | 84-2101.0 | 1 | 16 | 4 | 0.004 |
| | IP 67 | M | Aluminium black | | 84-1201.0 | 1 | 16 | 4 | 0.008 |
| | | | Aluminium blue | | 84-1201.6 | 1 | 16 | 4 | 0.008 |
| | | | Aluminium gold | | 84-1201.4 | 1 | 16 | 4 | 0.008 |
| | | | Aluminium natural | | 84-1201.7 | 1 | 16 | 4 | 0.008 |
| | | | Aluminium olive-green | | 84-1201.5 | 1 | 16 | 4 | 0.008 |
| | | | Aluminium red | | 84-1201.2 | 1 | 16 | 4 | 0.008 |
| | | | Plastic black | | 84-1101.0 | 1 | 16 | 4 | 0.003 |



Switching action: M = Momentary action

Mounting dimensions from page 34, Technical drawing from page 35, Circuit drawing from page 43

Indicator actuator with ring illumination (illuminated bezel)



Essential Accessories:

-  Illumination element page 17
-  Lens metal for Ring illumination page 14

| | Front protection | Front ring | Ø 25 mm Typ-Nr. | Mounting dimensions | Technical drawing |  |
|--|------------------|---------------------|--------------------|---------------------|-------------------|---|
| Indicator actuator with ring illumination (illuminated bezel) | IP 67 | Plastic translucent | 84-0090.7 | 1 | 16 | 0.006 |

Accessories for ring illumination:

Essential lenses Typ-Nr. 84-7202.x00A and 84-7205.x00A

Bi-colour illumination elements are not recommended.

Mounting dimensions from page 34, Technical drawing from page 35

Pushbutton actuator with ring illumination (illuminated bezel)



Essential Accessories:

-  Lens metal for Ring illumination page 14
-  Switching element illuminated page 19

| | Switching action | Front protection | Front ring | Ø 25 mm Typ-Nr. | Mounting dimensions | Technical drawing | Circuit drawing | |
|---|------------------|------------------|---------------------|--------------------|---------------------|-------------------|-----------------|-------|
| Pushbutton actuator with ring illumination (illuminated bezel) | M | IP 67 | Plastic translucent | 84-1091.7 | 1 | 16 | 4 | 0.006 |

Accessories for ring illumination:

Essential lenses Typ-Nr. 84-7202.x00A and 84-7205.x00A

Bi-colour switching elements are not recommended.

Switching action: M = Momentary action

Mounting dimensions from page 34, Technical drawing from page 35, Circuit drawing from page 43

Indicator actuator with ring illumination (illuminated multi-colour bezel)



Essential Accessories:

-  Illumination element PCB mounting page 21
-  Lens plastic page 13
-  Mounting flange page 21
-  Single-LED page 22





| | Front protection | Front ring | Ø 25 mm Typ-Nr. | Mounting dimensions | Technical drawing | |
|---|------------------|---------------------|--------------------|---------------------|-------------------|-------|
| Indicator actuator with ring illumination (illuminated multi-colour bezel) | IP 67 | Plastic transparent | 84-0080.7 | 1 | 16 | 0.006 |

Mounting dimensions from page 34, Technical drawing from page 35

Pushbutton actuator with ring illumination (illuminated multi-colour bezel)



Essential Accessories:

-  Lens plastic page 13
-  Mounting flange page 21
-  Single-LED page 22
-  Switching element PCB mounting illuminative page 21

| | Switching action | Front protection | | Ø 25 mm Typ-Nr. | Mounting dimensions | Technical drawing | Circuit drawing | |
|--|------------------|------------------|-----------------------------------|--------------------|---------------------|-------------------|-----------------|---|
| Pushbutton actuator with ring illumination (illuminated multi-colour bezel) | M | IP 67 | Front ring Plastic transparent | 84-1081.7 | 1 | 16 | 4 | 0.006  |

Switching action: M = Momentary action

Mounting dimensions from page 34, Technical drawing from page 35, Circuit drawing from page 43

Front

Lens plastic

| | Mounting type | Lens | Ø 25 mm Typ-Nr. |  |
|--|--------------------|------------------------|--------------------|---|
| Lens plastic flush - level, illuminative | level with bezel | blue transparent | 84-7111.600 | 0.001 |
| | | colourless transparent | 84-7111.700 | 0.001 |
| | | green transparent | 84-7111.500 | 0.001 |
| | | orange transparent | 84-7111.300 | 0.001 |
| | | red transparent | 84-7111.200 | 0.001 |
| | | yellow transparent | 84-7111.400 | 0.001 |
| flush - level, non-illuminative | level with bezel | black opaque | 84-7121.000 | 0.001 |
| | level with bezel | grey opaque | 84-7121.800 | 0.001 |
| flush - raised, illuminative | raised above bezel | blue transparent | 84-7115.600 | 0.001 |
| | | colourless transparent | 84-7115.700 | 0.001 |
| | | green transparent | 84-7115.500 | 0.001 |
| | | orange transparent | 84-7115.300 | 0.001 |
| | | red transparent | 84-7115.200 | 0.001 |
| | | yellow transparent | 84-7115.400 | 0.001 |
| flush - raised, non-illuminative | raised above bezel | black opaque | 84-7125.000 | 0.001 |
| | | grey opaque | 84-7125.800 | 0.001 |



Marking plate for lens plastic

can be hot stamped

| | Marking plate | Typ-Nr. |  |
|---------------------------------------|--------------------------------|------------------|---|
| Marking plate for lens plastic | Plastic colourless transparent | 61-9707.7 | 0.001 |



Lens plastic with symbol

| | Mounting type | Symbol | Lens | Ø 25 mm Typ-Nr. |  |
|--|------------------|----------|------------------------|--------------------|---|
| Lens plastic with symbol flush - level, illuminative | level with bezel | ON/OFF | blue transparent | 84-7111.602 | 0.002 |
| | | | colourless transparent | 84-7111.702 | 0.002 |
| | | | green transparent | 84-7111.502 | 0.002 |
| | | | red transparent | 84-7111.202 | 0.002 |
| | | Ring | blue transparent | 84-7111.601 | 0.002 |
| | | | colourless transparent | 84-7111.701 | 0.002 |
| | | | green transparent | 84-7111.501 | 0.002 |
| | | | orange transparent | 84-7111.301 | 0.002 |
| | | | red transparent | 84-7111.201 | 0.002 |
| | | | yellow transparent | 84-7111.401 | 0.002 |
| | | Stand by | blue transparent | 84-7111.603 | 0.002 |
| | | | colourless transparent | 84-7111.703 | 0.002 |
| | | | green transparent | 84-7111.503 | 0.002 |
| | | | red transparent | 84-7111.203 | 0.002 |



The silvery coat is being applied on the lens (screen print) with an additional protective lacquer.

Lens metal

| | Mounting type | Lens | Ø 25 mm Typ-Nr. |  |
|---|--------------------|-----------------------|--------------------|---|
| Lens metal convex - level, non-illuminative | level with bezel | Aluminium black | 84-7202.000 | 0.003 |
| | | Aluminium blue | 84-7202.600 | 0.003 |
| | | Aluminium gold | 84-7202.400 | 0.003 |
| | | Aluminium natural | 84-7202.800 | 0.003 |
| | | Aluminium olive-green | 84-7202.500 | 0.003 |
| | | Aluminium red | 84-7202.200 | 0.003 |
| flush - level, non-illuminative | level with bezel | Aluminium black | 84-7201.000 | 0.003 |
| | | Aluminium blue | 84-7201.600 | 0.003 |
| | | Aluminium gold | 84-7201.400 | 0.003 |
| | | Aluminium natural | 84-7201.800 | 0.003 |
| | | Aluminium olive-green | 84-7201.500 | 0.003 |
| | | Aluminium red | 84-7201.200 | 0.003 |
| flush - raised, non-illuminative | raised above bezel | Aluminium black | 84-7205.000 | 0.003 |
| | | Aluminium blue | 84-7205.600 | 0.003 |
| | | Aluminium gold | 84-7205.400 | 0.003 |
| | | Aluminium natural | 84-7205.800 | 0.003 |
| | | Aluminium olive-green | 84-7205.500 | 0.003 |
| | | Aluminium red | 84-7205.200 | 0.003 |



Lens metal for Ring illumination

| | Mounting type | Lens | Ø 25 mm Typ-Nr. |  |
|--|--------------------|-----------------------|---------------------|---|
| Lens metal for Ring illumination convex - raised, non-illuminative | raised above bezel | Aluminium black | 84-7202.000A | 0.004 |
| | | Aluminium blue | 84-7202.600A | 0.004 |
| | | Aluminium gold | 84-7202.400A | 0.004 |
| | | Aluminium natural | 84-7202.800A | 0.004 |
| | | Aluminium olive-green | 84-7202.500B | 0.004 |
| | | Aluminium red | 84-7202.200A | 0.004 |
| flush - raised, non-illuminative | raised above bezel | Aluminium black | 84-7205.000A | 0.003 |
| | | Aluminium blue | 84-7205.600A | 0.003 |
| | | Aluminium gold | 84-7205.400A | 0.003 |
| | | Aluminium natural | 84-7205.800A | 0.003 |
| | | Aluminium olive-green | 84-7205.500A | 0.003 |
| | | Aluminium red | 84-7205.200A | 0.003 |



Lens metal with spot

| | Mounting type | Lens | Ø 25 mm Typ-Nr. |  |
|--|--------------------|-----------------------|--------------------|---|
| Lens metal with spot flush - level, illuminative | level with bezel | Aluminium black | 84-7211.000 | 0.002 |
| | | Aluminium blue | 84-7211.600 | 0.002 |
| | | Aluminium gold | 84-7211.400 | 0.002 |
| | | Aluminium natural | 84-7211.800 | 0.002 |
| | | Aluminium olive-green | 84-7211.500 | 0.002 |
| | | Aluminium red | 84-7211.200 | 0.002 |
| flush - raised, illuminative | raised above bezel | Aluminium black | 84-7215.000 | 0.002 |
| | | Aluminium blue | 84-7215.600 | 0.002 |
| | | Aluminium gold | 84-7215.400 | 0.002 |
| | | Aluminium natural | 84-7215.800 | 0.002 |
| | | Aluminium olive-green | 84-7215.500 | 0.002 |
| | | Aluminium red | 84-7215.200 | 0.002 |



Mushroom-head cap

| | Mushroom had cap | Ø 32 mm Typ-Nr. |  |
|--------------------------|--------------------------|---------------------|---|
| Mushroom-head cap | Plastic black opaque | 84-7124.000A | 0.004 |
| | Plastic blue opaque | 84-7124.600A | 0.004 |
| | Plastic blue transparent | 84-7114.600A | 0.004 |
| | Plastic green opaque | 84-7124.500A | 0.004 |
| | Plastic red opaque | 84-7124.200A | 0.004 |
| | Plastic yellow opaque | 84-7124.400A | 0.004 |



Front protective cap

for flush - level lenses only for protection IP 68

| | Front protective cap | Typ-Nr. |  |
|-----------------------------|------------------------------|------------------|---|
| Front protective cap | Silicone natural transparent | 84-9103.7 | 0.001 |

ATTENTION

when using the front protection cover the external sealing in the actuator has to be removed !



Legend frame

for devices 25 mm dia.

| | | Typ-Nr. | Technical drawing |  |
|--|--|------------------|-------------------|---|
| Legend frame 30 x 50 mm, adhesive, Aluminium black | | 61-9980.0 | 7 | 0.001 |



Technical drawing from page 35

Legend plate insert

for Legend frame 61-9980.0

| | Typ-Nr. |  |
|---|------------------|---|
| Legend plate insert 14.5 x 23.5 mm, adhesive, Aluminium black | 704.968.1 | 0.001 |
| 14.5 x 23.5 mm, adhesive, Aluminium natural | 704.968.0 | 0.001 |



Blind plug

| | Blind plug | Typ-Nr. | Technical drawing |  |
|--|---------------|------------------|-------------------|---|
| Blind plug Size 25 mm dia., for mounting hole 22.5 mm dia. | Plastic black | 61-9453.0 | 8 | 0.006 |
| Size 36 mm dia., for mounting hole 30.5 mm dia. | Plastic black | 704.964.8 | 1 | 0.007 |



Technical drawing from page 35

Backside

Illumination element

| | Protection degree | Illumination | Operating voltage/- current | Terminals | Typ-Nr. | Circuit drawing |  |
|--|-------------------|-------------------|--------------------------------|-----------|---------------------|-----------------|---|
| Illumination element LED and built-in resistor included | IP 40 | Single-LED blue | 12 VDC, 10 mA | FR | 84-8001.6340 | 5 | 0.010 |
| | | | | PT 2.8 s | 84-8001.6320 | 5 | 0.005 |
| | | | 24 VDC, 10 mA | FR | 84-8001.6640 | 5 | 0.010 |
| | | | | PT 2.8 s | 84-8001.6620 | 5 | 0.005 |
| | | Single-LED green | 12 VDC, 10 mA | FR | 84-8001.5340 | 5 | 0.010 |
| | | | | PT 2.8 s | 84-8001.5320 | 5 | 0.005 |
| | | | 24 VDC, 10 mA | FR | 84-8001.5640 | 5 | 0.010 |
| | | | | PT 2.8 s | 84-8001.5620 | 5 | 0.005 |
| | | Single-LED orange | 12 VDC, 10 mA | FR | 84-8001.3340 | 5 | 0.010 |
| | | | | PT 2.8 s | 84-8001.3320 | 5 | 0.005 |
| | | | 24 VDC, 10 mA | FR | 84-8001.3640 | 5 | 0.010 |
| | | | | PT 2.8 s | 84-8001.3620 | 5 | 0.005 |
| | | Single-LED red | 12 VDC, 10 mA | FR | 84-8001.2340 | 5 | 0.010 |
| | | | | PT 2.8 s | 84-8001.2320 | 5 | 0.005 |
| | | | 24 VDC, 10 mA | FR | 84-8001.2640 | 5 | 0.010 |
| | | | | PT 2.8 s | 84-8001.2620 | 5 | 0.005 |
| | | Single-LED white | 12 VDC, 10 mA | FR | 84-8001.9340 | 5 | 0.010 |
| | | | | PT 2.8 s | 84-8001.9320 | 5 | 0.005 |
| | | | 24 VDC, 10 mA | FR | 84-8001.9640 | 5 | 0.010 |
| | | | | PT 2.8 s | 84-8001.9620 | 5 | 0.005 |
| | | Single-LED yellow | 12 VDC, 10 mA | FR | 84-8001.4340 | 5 | 0.010 |
| | | | | PT 2.8 s | 84-8001.4320 | 5 | 0.005 |
| | | | 24 VDC, 10 mA | FR | 84-8001.4640 | 5 | 0.010 |
| | | | | PT 2.8 s | 84-8001.4620 | 5 | 0.005 |



Standard version:

Cable length 300 mm with insulated ferrule; Plug-in terminal 2.8 x 0.8 mm.

Other options on request:

Customisation of cable and connectors; Rear side fully sealed (IP 67).

Protection degree (rear side):

IP 40, upgrade to IP 67 with plug typ-Nr. 84-900 possible; With applications where strong vibrations occur, the plugs may become loose.

Terminals: FR = Flat ribbon cable, PT 2.8 s = Plug-in terminal 2.8 mm (solderable)

Circuit drawing from page 43

Illumination element with Bi-colour illumination

| | Illumination | Operating voltage/- current | Protection degree | Terminals | Typ-Nr. | Circuit drawing | |
|---|-------------------------------|--------------------------------|-------------------|-----------|---------------------|-----------------|-------|
| Illumination element with Bi-colour illumination LED and built-in resistor included | Bi-colour LED red/green | 24 VDC, 20 mA | IP 40 | PT 2.8 s | 84-8005.8620 | 1 | 0.005 |
| | | | IP 67 | FR | 84-8005.8640 | 2 | 0.011 |
| | Bi-colour LED yellow/green | 24 VDC, 20 mA | IP 40 | PT 2.8 s | 84-8005.7620 | 1 | 0.005 |
| | | | IP 67 | FR | 84-8005.7640 | 2 | 0.011 |



Standard version:

Cable length 300 mm with insulated ferrule; Plug-in terminal 2.8 x 0.8 mm.

Other options on request:

Customisation of cable and connectors; Rear side fully sealed (IP 67).

Best illumination level will be reached with Alu lens with window, Typ-Nr. 84-7215.x00 and 84-7211.x00.

Protection degree (rear side):

- Plug-in terminal IP 40, upgrade to IP 67 with plug typ-Nr. 84-900 possible. With applications where strong vibrations occur, the plugs may become loose.

- Cable connection IP 67, rear side fully sealed. The illumination element of the cable version cannot be disconnected from the actuator any longer.

Terminals: PT 2.8 s = Plug-in terminal 2.8 mm (solderable), FR = Flat ribbon cable

Circuit drawing from page 43

Switching element illuminated

| | Protection degree | Contacts | Illumination | Operating voltage/ current | Terminals | Typ-Nr. | Circuit drawing | |
|--|-------------------|----------|-------------------|-------------------------------|-----------|---------------------|-----------------|-------|
| Switching element illuminated LED and built-in resistor included | IP 40 | 1 NO | Single-LED blue | 12 VDC, 10 mA | FR | 84-8511.6340 | 7 | 0.015 |
| | | | | | PT 2.8 s | 84-8511.6320 | 7 | 0.006 |
| | | | | 24 VDC, 10 mA | FR | 84-8511.6640 | 7 | 0.015 |
| | | | | | PT 2.8 s | 84-8511.6620 | 7 | 0.006 |
| | | | | 12 VDC, 10 mA | FR | 84-8511.5340 | 7 | 0.015 |
| | | | | | PT 2.8 s | 84-8511.5320 | 7 | 0.006 |
| | | | Single-LED green | 24 VDC, 10 mA | FR | 84-8511.5640 | 7 | 0.015 |
| | | | | | PT 2.8 s | 84-8511.5620 | 7 | 0.006 |
| | | | | 12 VDC, 10 mA | FR | 84-8511.3340 | 7 | 0.015 |
| | | | | | PT 2.8 s | 84-8511.3320 | 7 | 0.006 |
| | | | | 24 VDC, 10 mA | FR | 84-8511.3640 | 7 | 0.015 |
| | | | | | PT 2.8 s | 84-8511.3620 | 7 | 0.006 |
| | | | Single-LED orange | 12 VDC, 10 mA | FR | 84-8511.2340 | 7 | 0.015 |
| | | | | | PT 2.8 s | 84-8511.2320 | 7 | 0.006 |
| | | | | 24 VDC, 10 mA | FR | 84-8511.2640 | 7 | 0.015 |
| | | | | | PT 2.8 s | 84-8511.2620 | 7 | 0.006 |
| | | | | 12 VDC, 10 mA | FR | 84-8511.9340 | 7 | 0.015 |
| | | | | | PT 2.8 s | 84-8511.9320 | 7 | 0.006 |
| | | | Single-LED red | 24 VDC, 10 mA | FR | 84-8511.9640 | 7 | 0.015 |
| | | | | | PT 2.8 s | 84-8511.9620 | 7 | 0.006 |
| | | | | 12 VDC, 10 mA | FR | 84-8511.4340 | 7 | 0.015 |
| | | | | | PT 2.8 s | 84-8511.4320 | 7 | 0.006 |
| | | | | 24 VDC, 10 mA | FR | 84-8511.4640 | 7 | 0.015 |
| | | | | | PT 2.8 s | 84-8511.4620 | 7 | 0.006 |



Standard version:

Cable length 300 mm with insulated ferrule; Plug-in terminal 2.8 x 0.8 mm.

Other options on request:

Customisation of cable and connectors; Rear side fully sealed (IP 67).

Protection degree (rear side):

IP 40, upgrade to IP 67 with plug typ-Nr. 84-900 possible; With applications where strong vibrations occur, the plugs may become loose.

Contacts: NO = Normally open

Terminals: FR = Flat ribbon cable, PT 2.8 s = Plug-in terminal 2.8 mm (solderable)

Circuit drawing from page 43

Switching element with Bi-colour illumination

| | Protection degree | Contacts | Illumination | Operating voltage/ current | Terminals | Typ-Nr. | Circuit drawing |  |
|--|-------------------|----------|----------------------------|-------------------------------|-----------|---------------------|-----------------|---|
| Switching element with Bi-colour illumination LED and built-in resistor included | IP 67 | 1 NO | Bi-colour LED red/green | 24 VDC, 20 mA | FR | 84-8515.8640 | 3 | 0.015 |
| | | | Bi-colour LED yellow/green | 24 VDC, 20 mA | FR | 84-8515.7640 | 3 | 0.015 |



Protection degree IP 67, rear side fully sealed. The switching element cannot be disconnected from the actuator any longer.

Best illumination level will be reached with Alu lens with window, Typ-Nr. 84-7215.x00 and 84-7211.x00.

Standard version:

Cable length 300 mm with insulated ferrule.

Other options on request:

Customisation of cable and connectors.

Contacts: NO = Normally open

Terminals: FR = Flat ribbon cable

Circuit drawing from page 43

Switching element non-illuminated

| | Protection degree | Contacts | Terminals | Typ-Nr. | Circuit drawing |  |
|--|-------------------|----------|-----------|---------------------|-----------------|---|
| Switching element non-illuminated | IP 40 | 1 NO | FR | 84-8510.0040 | 6 | 0.010 |
| | | | PT 2.8 s | 84-8510.0020 | 6 | 0.005 |



Standard version:

Cable length 300 mm with insulated ferrule; Plug-in terminal 2.8 x 0.8 mm (solderable).

Other options on request:

Customisation of cable and connectors; Rear side fully sealed (IP 67).

Protection degree (rear side):

IP 40, upgrade to IP 67 with plug typ-Nr. 84-900 possible; With applications where strong vibrations occur, the plugs may become loose.

Contacts: NO = Normally open

Terminals: FR = Flat ribbon cable, PT 2.8 s = Plug-in terminal 2.8 mm (solderable)

Circuit drawing from page 43

Switching element PCB mounting illuminative

The customer has to decide what series resistor shall be used to the LED

| | Contacts | Terminals | Typ-Nr. | Component layout | Technical drawing | Circuit drawing |  |
|--|----------|-----------|-------------------|------------------|-------------------|-----------------|---|
| Switching element PCB mounting illuminative | 1 NO | P | 92-851.342 | 4 | 15 | 14 | 0.001 |



Illumination and mounting flange to be ordered separately.

Contacts: NO = Normally open

Terminals: P = PCB terminal

Component layout from page 31, Technical drawing from page 35, Circuit drawing from page 43

Illumination element PCB mounting

The customer has to decide what series resistor shall be used to the LED

| | Terminals | Typ-Nr. | Component layout | Technical drawing |  |
|--|-----------|-------------------|------------------|-------------------|---|
| Illumination element PCB mounting | P | 92-800.042 | 3 | 9 | 0.001 |



Illumination and mounting flange to be ordered separately.

Terminals: P = PCB terminal

Component layout from page 31, Technical drawing from page 35

Mounting flange

| | Typ-Nr. | Technical drawing |  |
|---|-----------------|-------------------|---|
| Mounting flange Ring illumination (illuminated multi-color bezel) | 84-960.0 | 13 | 0.001 |
| Standard version (non-illuminated) | 92-960.0 | 10 | 0.001 |



Technical drawing from page 35

Flat receptacle

| | Typ-Nr. |  |
|--|----------------|---|
| Flat receptacle 2.8 x 0.8 mm | 84-9420 | 0.001 |



Insulation sleeve

| | Typ-Nr. |  |
|--|---------------|---|
| Insulation sleeve for Flat receptacles 84-9420 | 31-929 | 0.001 |



Plug

| | Typ-Nr. |  |
|-------------|---------------|---|
| Plug | 84-900 | 0.001 |



for back protection IP67 of switching elements and illumination elements.
Two plugs are necessary per element.

Illumination

Single-LED

The customer has to decide what series resistor shall be used to the LED

| | Socket | Light colour | Operating voltage/-current | Typ-Nr. |  |
|-------------------|-----------|--------------|----------------------------|----------------------|---|
| Single-LED | T1 Bi-Pin | blue | 3.5 VDC, 20 mA | 10-2602.3206L | 0.001 |
| | | green | 3.5 VDC, 20 mA | 10-2602.3205L | 0.001 |
| | | orange | 2.1 VDC, 20 mA | 10-2602.3203L | 0.001 |
| | | red | 2.1 VDC, 20 mA | 10-2602.3202L | 0.001 |
| | | white | 3.5 VDC, 20 mA | 10-2602.3209L | 0.001 |
| | | yellow | 2.2 VDC, 20 mA | 10-2602.3174D | 0.001 |



Bi-colour LED

The customer has to decide what series resistor shall be used to the LED

| | Socket | Light colour | Operating voltage/-current | Typ-Nr. |  |
|----------------------|-----------|--------------|----------------------------|----------------------|---|
| Bi-colour LED | T1 Bi-Pin | red/green | 1.9/3.5 VDC, 20 mA | 10-2603.320AL | 0.001 |
| | | yellow/green | 2.0/3.2 VDC, 20 mA | 10-2603.320CL | 0.001 |



Multi-LED

The customer has to decide what series resistor shall be used to the LED

| | Socket | Light colour | Operating voltage/-current | Typ-Nr. |  |
|------------------|-----------|--------------|----------------------------|----------------------|---|
| Multi-LED | T1 Bi-Pin | yellow | 12 VDC, 40 mA | 10-5609.3174D | 0.001 |



Emergency-stop and Stop pushbutton

Emergency-stop label

front panel thickness 3 mm max.

| | Marking | Typ-Nr. |  |
|--|-----------------|------------------|---|
| Emergency-stop label 60 mm dia., yellow, Mounting hole size 22.5 mm dia. | ARRET D'URGENCE | 704.963.7 | 0.011 |
| | EMERGENCY STOP | 704.963.6 | 0.011 |
| | NOT AUS | 704.963.5 | 0.011 |
| | NOT HALT | 704.963.8 | 0.011 |
| 90 mm dia., yellow, Mounting hole size 22.5 mm dia. | ARRET D'URGENCE | 704.963.2 | 0.011 |
| | EMERGENCY STOP | 704.963.1 | 0.011 |
| | NOT AUS | 704.963.0 | 0.011 |
| | NOT HALT | 704.963.3 | 0.011 |



Emergency-stop protective shroud

Front panel thickness 1 ... 3 mm

| | Protective shroud | Marking | Typ-Nr. | Technical drawing |  |
|--|-----------------------|----------------|----------------|-------------------|---|
| Emergency-stop protective shroud 45 mm dia., IP 40, mounting hole 22.5 mm dia., with anti-twist device | Metal yellow RAL 1004 | without | 84-909 | 12 | 0.021 |
| 50 mm dia., IP 65, mounting hole 22.5 mm dia., with anti-twist device | Plastic yellow | EMERGENCY STOP | 84-902B | 14 | 0.006 |
| | | NOT - AUS | 84-902A | 14 | 0.006 |
| | | NOT - HALT | 84-902D | 14 | 0.006 |
| | | without | 84-902 | 14 | 0.006 |



Please note: By using the protective shroud Typ-Nr. 84-909 the E-stop or Stop-Switch has to be mounted twisted by 180°. Consult the dimensional drawing therefore.
Technical drawing from page 35

Fixing nut

| | Fixing nut | Typ-Nr. |  |
|---|---------------|---------------|---|
| Fixing nut 28 mm dia., for limited-space applications | Plastic black | 84-905 | 0.002 |
| 30 mm dia., standard delivery | Plastic black | 84-908 | 0.002 |



Emergency-stop enclosures

Bottom grey similar RAL 7035; cover lead-sealable, yellow similar RAL 1004

| | Dimension | Typ-Nr. | Technical drawing |  |
|--|---------------------------|---------------|-------------------|---|
| Emergency-stop enclosures with mounting hole 22.5 mm dia., with anti- twist device | L 65 mm, W 65 mm, H 57 mm | 84-910 | 11 | 0.099 |



Openings for cable gland M16 or M20.

Protection class IP 66.

Technical drawing from page 35

Stop pushbutton enclosure

Grey similar RAL 7035; cover lead-sealable

| | Dimension | Typ-Nr. | Technical drawing |  |
|---|------------------------------|------------------|-------------------|---|
| Stop pushbutton enclosure with mounting hole 1 x 22.5 mm dia., with anti-twist device | L 94 mm, W 94 mm, H 81 mm | 704.945.1 | 2 | 0.211 |
| with mounting hole 2 x 22.5 mm dia., with anti-twist device | L 130 mm, W 94 mm, H 81 mm | 704.945.2 | 3 | 0.251 |
| with mounting hole 3 x 22.5 mm dia., with anti-twist device | L 180 mm, W 94 mm, H 81 mm | 704.945.3 | 4 | 0.313 |
| with mounting hole 4 x 22.5 mm dia., with anti-twist device | L 180 mm, W 182 mm, H 110 mm | 704.945.4 | 5 | 0.572 |
| with mounting hole 6 x 22.5 mm dia., with anti-twist device | L 180 mm, W 182 mm, H 110 mm | 704.945.5 | 6 | 0.568 |



Technical drawing from page 35

Cable gland

| | Typ-Nr. |  |
|---|------------------|---|
| Cable gland M16, Plastic grey | 61-9481.6 | 0.007 |
| M20, Plastic grey | 704.945.6 | 0.011 |



with traction relief; protection degree IP 68.

Flat receptacle

| | Typ-Nr. |  |
|---|---------------|---|
| Flat receptacle 2.8 x 0.5 mm for Plug-in terminal | 31-946 | 0.001 |



Insulation sleeve

| | Typ-Nr. |  |
|---|---------------|---|
| Insulation sleeve for Flat receptacles 31-946 | 31-929 | 0.001 |



Stop request pushbutton

Housing, pole mounting 35 mm dia.

| | Housing | Colour | Typ-Nr. | Technical drawing |  |
|--|----------------|-----------------------|-------------------|-------------------|---|
| Housing, pole mounting 35 mm dia. | Plastic blue | RAL 5017 traffic blue | 84-9500.6A | 19 | 0.035 |
| | Plastic grey | RAL 7016 | 84-9500.8 | 19 | 0.035 |
| | Plastic yellow | RAL 1023 | 84-9500.4 | 19 | 0.035 |



Screws are not contained in the scope of supply.
Technical drawing from page 35

Housing, pole mounting 38 mm dia.

| | Housing | Colour | Typ-Nr. | Technical drawing |  |
|--|----------------|----------|------------------|-------------------|---|
| Housing, pole mounting 38 mm dia. | Plastic grey | RAL 7016 | 84-9600.8 | 20 | 0.030 |
| | Plastic yellow | RAL 1023 | 84-9600.4 | 20 | 0.030 |



Screws are not contained in the scope of supply.
Technical drawing from page 35

Adaptor, reducing to 30 mm dia.

| | Housing | Colour | Typ-Nr. | Technical drawing |  |
|---|----------------|----------|------------------|-------------------|---|
| Adaptor, reducing to 30 mm dia. for housing, pole mounting 35 mm dia. | Plastic grey | RAL 7016 | 84-9700.8 | 23 | 0.024 |
| | Plastic yellow | RAL 1023 | 84-9700.4 | 23 | 0.024 |



Technical drawing from page 35

Adaptor, reducing to 25 mm dia.

| | Housing | Colour | Typ-Nr. | Technical drawing |  |
|---|----------------|----------|------------------|-------------------|---|
| Adaptor, reducing to 25 mm dia. for housing, pole mounting 35 mm dia. | Plastic grey | RAL 7016 | 84-9300.8 | 22 | 0.008 |
| | Plastic yellow | RAL 1023 | 84-9300.4 | 22 | 0.008 |



Technical drawing from page 35

Housing, wall mounting

| | Housing | Colour | Typ-Nr. | Technical drawing |  |
|-------------------------------|----------------|----------|------------------|-------------------|---|
| Housing, wall mounting | Plastic grey | RAL 7016 | 84-9800.8 | 21 | 0.024 |
| | Plastic yellow | RAL 1023 | 84-9800.4 | 21 | 0.024 |



Screws are not contained in the scope of supply.
Technical drawing from page 35

Assembling

Lens remover

| | Typ-Nr. |  |
|---------------------|------------------|---|
| Lens remover | 61-9730.0 | 0.011 |



Mounting tool

| | Typ-Nr. |  |
|--|---------------|---|
| Mounting tool for tightening or loosening of Emergency-stop and Stop-Switch fixing nut | 84-996 | 0.014 |
| for tightening or loosening of Fixing nut, Indicator and Pushbutton | 84-997 | 0.027 |



Dismantling tool

| | Typ-Nr. |  |
|--|---------------|---|
| Dismantling tool for actuator dismantling of switching- and illumination element and mounting flange | 84-998 | 0.002 |



Emergency-stop

Switching system

The double-break switching system can be supplied for the following switching functions:

1 Normally closed, 2 Normally closed, 1 Normally closed + 1 Normally open.

The Normally closed contacts have forced opening according to EN IEC 60947-5-1

Material

Connection cable

Polyvinylchloride (PVC), operating temperature up to +65 °C

Mushroom-head cap

Polybutylenterephthalate (PBT), as per UL 94 V0 (red items)

Actuator housing

Polyamide (PA 66), as per UL 94 V0, Flat ribbon cable-cover
Polyamide (PA 6.6), as per UL 94 V0

Material of contact

Silver alloy gold plated

Mechanical characteristics

Front panel thickness

Standard 1 ... 4 mm
with E-stop protective shroud Typ-Nr. 84-902 1 ... 3 mm

Mounting hole

22.5 mm dia. as per EN IEC 60947-5-1 with anti-twist device

Terminals

Soldering terminals 2.8 x 0.5 mm (solderable), CuSn6 tin-plated
Flat ribbon cable 2-, 4-, or 6-poles 0.35 mm² (AWG 22)

Tightening torque

Fixing nut 80 Ncm

Actuating force

22 N ±4 N

Actuating travel

approx. 4 mm to release the internal operation part

Mechanical lifetime

≥50.000 cycles of operations

Electrical characteristics

Standards

The devices comply with : EN IEC 60947-5-1, EN IEC 60947-5-5 (Emergency-stop), DIN EN ISO 13850, EN IEC 60204

Illumination

LED red with pole reversal, constant current source

Operation Voltage 5 VDC ... 30 VDC
Current consumption 9.7 mA ... 12.4 mA

Rated Operational Voltage U_e

250 VAC, as per EN IEC 60947-1

Rated Insulation Voltage U_i

250 V, as per EN IEC 60947-1

Rated Impulse Withstand Voltage U_{imp}

2.5 kV, as per EN IEC 60947-1

Contact resistance

New state ≤ 50 mΩ, as per DIN IEC 60512-2-3

Isolation resistance

>10¹¹ Ω between the open contacts at 500 VDC, as per DIN IEC 60512-2-10

Electrical life

≥50 000 cycles of operations (inductive cosφ 0.4), as per EN IEC 60947-5-1

| | | | | |
|---------|---------|---------|---------|---------|
| Voltage | 120 VAC | 240 VAC | 125 VDC | 250 VDC |
| Current | 3 A | 1.5 A | 0.55 A | 0.27 A |

Reduced load ≥50'000 cycles of operations (resistive)

| | | |
|---------|----------|-----------|
| Voltage | 1 VAC/DC | 42 VAC/DC |
| Current | 100 mA | 200 mA |

Conventional free air thermal current I_{th}

5 A, as per EN IEC 60947-5-1

the maximum current in continuous operation and at ambient temperature must not exceed the quoted maximum values.

Switch rating

Switch rating AC with silver contact (gold plated), service category AC-15, as per EN IEC 60947-5-1

| | | |
|---------|---------|---------|
| Voltage | 120 VAC | 240 VAC |
| Current | 3 A | 1.5 A |

Switch rating DC for silver contact (gold plated), service category DC-13, as per EN IEC 60947-5-1 (inductive)

| | | | | | | |
|--------------------------|--------|--------|--------|--------|---------|---------|
| Voltage | 12 VDC | 24 VDC | 48 VDC | 60 VDC | 125 VDC | 250 VDC |
| Current _{Plug} | 5 A | 4 A | 2.1 A | 1.7 A | 0.55 A | 0.27 A |
| Current _{Cable} | 3 A | 3 A | 2.1 A | 1.7 A | 0.55 A | 0.27 A |

Recommended minimum operational data

Silver contacts (gold plated)

| | |
|---------|----------|
| Voltage | 1 VAC/DC |
| Current | 1 mA |

Electric strength

500 VAC, 50 Hz, 1 min, as per DIN IEC 60512-2

Rated conditional short-circuit current

1000 A, type of short-circuit unit 6 A gG, as per EN IEC 60947-5-1

Protection class

Class II, as per EN IEC 60947-5

Overvoltage category

II, as per EN IEC 60947-1

Degree of pollution

3, as per EN IEC 60947-1

Environmental conditions

Storage temperature

-25 °C ... +80 °C

Operating temperature

-25 °C ... +65 °C

Front protection

IP 65, as per EN IEC 60529

Shock resistance

(semi-sinusoidal)

max. 150 m/s², pulse width 11 ms, 3-axis, as per EN IEC 60068-2-27

Vibration resistance

(sinusoidal)

max. 50 m/s² at 10 Hz ... 500 Hz, 10 cycles, 3-axis, as per EN IEC 60068-2-6

Climate resistance

Damp heat, cyclic

96 hours, +25 °C / 97 %, +55 °C / 93 % relative humidity, as per EN IEC 60068-2-30

Damp heat, steady

56 days, +40 °C / 93 % relative humidity, as per EN IEC 60068-2-78

Dry heat

96 hours, +70 °C, as per EN IEC 60068-2-2

Low temperature

96 hours, -40 °C, as per EN IEC 60068-2-1

Saline mist

96 Stunden, +35 °C in chemical solution NaCl, as per EN IEC 60068-2-11

Approvals

Approbations

SEV
UL

Declaration of conformity

CE

Switching element illuminated pushbutton

Switching system

Short-travel switching system with 2 independent contact points and tactile operation.

Guarantees reliable switching even of very light loads.

Fitted with 1 normally open contact.

Material

Connection cable

Polyvinylchloride (PVC), short-time heat-resistant up to 105 °C

Material of contact

Silver alloy gold plated

Switching element

Thermoplastic polyester (PET, PBT), as per UL 94 V0 and Polyacetale (POM), as per UL 94 HB

Mechanical characteristics

Terminals

Plug-in terminals 2.8 x 0.8 mm (solderable)

Flat ribbon cable 0.5 mm²

PCB terminal

Actuating force

4.0 N ±0.2 N (measured at the lens)

Actuating travel

~0.5 mm

Rebound time

≤1 ms

Resistance to heat of soldering

260 °C, 5 s (PCB assembly)

350 °C, 10 s (when using a soldering iron)

as per EN IEC 60068-2-20

Mechanical lifetime

≥1 million cycles of operations

Electrical characteristics

Illumination

Single-Chip or Multi-Chip LED, green, orange, red, yellow, white and blue

Operation Voltage 12 VDC 24 VDC

Current consumption 40 mA 20 mA

Contact resistance

Starting value (initial) ≤100 mΩ, as per DIN IEC 60512-2

Isolation resistance

≥1 G Ω between all terminals at 100 VDC, as per DIN IEC 60512-2

Electrical life

as per EN IEC 60512-5

| | | |
|-----------|---------------------|------------------------------|
| 5 million | cycles of operation | 24 VAC, 50 mA at 480 Ω |
| 5 million | cycles of operation | 24 VAC, 100 mA at 240 Ω |
| 2 million | cycles of operation | 42 VAC, 50 mA at 840 Ω |
| 2 million | cycles of operation | 42 VAC, 100 mA at 420 Ω |
| 300 000 | cycles of operation | 42 VAC, 100 mA at cosφ 0,4 |
| 250 000 | cycles of operation | 42 VAC, 200 mA at cosφ 0,395 |

| | | |
|-------------|---------------------|-------------------------|
| 1 million | cycles of operation | 12 VDC, 250 mA at 48 Ω |
| 1 million | cycles of operation | 24 VDC, 50 mA at 480 Ω |
| 1 million | cycles of operation | 24 VDC, 100 mA at 240 Ω |
| 5 million | cycles of operation | 42 VDC, 25 mA at 1680 Ω |
| 1.5 million | cycles of operation | 42 VDC, 50 mA at 840 Ω |
| 100 000 | cycles of operation | 42 VDC, 100 mA at 420 Ω |

| | | |
|---------|---------------------|-----------------------------|
| 500 000 | cycles of operation | 24 VDC, 200 mA at L/R=30 ms |
| 300 000 | cycles of operation | 42 VDC, 100 mA at L/R=30 ms |
| 100 000 | cycles of operation | 42 VDC, 200 mA at L/R=30 ms |

Switch rating

Voltage 50 mVAC/DC ... 42 VAC/DC

Current 10 uA ... 100 mA

Power max. 2 W

Electric strength

500 VAC, 50 Hz, 1 min, as per DIN IEC 60512-2

Environmental conditions

Storage temperature

-40 °C ... +85 °C

Operating temperature

-25 °C ... +70 °C

Protection degree

Back protection:

IP 40, standard version

IP 67, fully sealed version, with mounted actuator only.

Shock resistance

(semi-sinusoidal)

max. 100 m/s², pulse width 11 ms, 3-axis, as per EN IEC 60068-2-27

Vibration resistance

(sinusoidal)

max. 50 m/s² at 10 Hz ... 500 Hz, 10 cycles, 3-axis, as per EN IEC 60068-2-6

Actuator

Material

Lens

Polycarbonate (PC), as per UL 94 V2 or Aluminium anodised

Actuator housing

Polyetherimid (PEI), as per UL 94 V0 or Aluminium anodised

Mechanical characteristics

Mounting hole

22.5 mm dia. and 30.5 mm dia.

Tightening torque

Fixing nut max. 80 Ncm

Actuating force

4.0 N ±0.2 N (measured at the lens)

Actuating travel

Total switching travel 1.2 mm

Mechanical lifetime

≥1 million cycles of operations

Electrical characteristics

Electrostatic breakdown value

Plastic case ≥15 kV

Aluminium case ≥5 kV

as per IEC 61000-4-2, mounted in plastic front panel

Environmental conditions

Storage temperature

-40 °C ... +85 °C

Operating temperature

-25 °C ... +70 °C

Front protection

IP 67 and IP40, as per EN IEC 60529

Climate resistance

Damp heat, cyclic

96 hours, +25 °C / 97 %, +55 °C / 93 % relative humidity, as per EN IEC 60068-2-30

Damp heat, state

56 days, +40 °C / 93 % relative humidity, as per EN IEC 60068-2-78

Rapid change of temperature

100 cycles, -40 °C ... +80 °C, as per EN IEC 60068-2-14

Suppressor circuits

When switching inductive loads such as relays, DC motors, and DC solenoids, it is always important to absorb surges (e.g. with a diode) to protect the contacts. When these inductive loads are switched off, a counter emf can severely damage switch contacts and greatly shorten lifetime.

Fig. 1 shows an inductive load with a free-wheeling diode connected in parallel. This free-wheeling diode provides a path for the inductor current to flow when the current is interrupted by the switch. Without this free-wheeling diode, the voltage across the coil will be limited only by dielectric breakdown voltages of the circuit or parasitic elements of the coil. This voltage can be kilovolts in amplitude even when nominal circuit voltages are low (e.g. 12 VDC) see Fig. 2.

The free-wheeling diode should be chosen so that the reverse breakdown voltage is greater than the voltage driving the inductive load. The DC blocking voltage (VR) of the free-wheeling diode can be found in the datasheet of a diode. The forward current should be equal or greater than the maximum current flowing through the load.

To get an efficient protection, the free-wheeling diode must be connected as close as possible to the inductive load!

Switching with inductive load
Fig. 1



Counter emf
over load without free-wheeling diode
Fig. 2

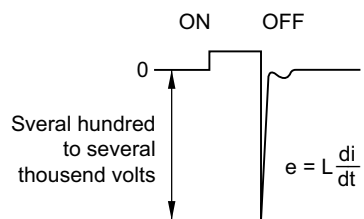

Component layout

1 Emergency-stop pushbutton, foolproof EN IEC 60947-5-5, complete page 7 | Stop pushbutton grey, complete page 8



2 Emergency-stop pushbutton, foolproof EN IEC 60947-5-5, complete page 7 | Stop pushbutton grey, complete page 8



3 Illumination element PCB mounting page 21

Single-LED

Drilling plan (Elementside)

- A Fixing holes for mounting flange (92-960.0)
- B Holes for LED
- C Holes for centering pins



Bi-colour-LED

Drilling plan (Elementside)

- A Fixing holes for mounting flange (92-960.0)
- B Holes for Bi-colour LED:
BA1 (green) + BA2 (yellow or red) = Anodes, BC = Cathode
- C Holes for centering pins



Hyper mini SMD-LED

Drilling plan (Elementside)

- A Fixing holes for mounting flange (84-960.0)



Libraries for the PCB layout-system p-cad 200X see : www.pcad.com/en/library Third-party Libraries

4 Switching element PCB mounting illuminative page 21

Single-LED

Drilling plan (Elementside)

- A Fixing holes for mounting flange (92-960.0)
- B Holes for LED
- C Holes for contact pins
Pad max. Ø 2.5 mm
Through-connection recommended



Bi-colour-LED

Drilling plan (Elementside)

- A Fixing holes for mounting flange (92-960.0)
- B Holes for Bi-colour LED:
BA1 (green) + BA2 (yellow or red) = Anodes, BK = Cathode
- C Holes for contact pins
Pad max. Ø 2.5 mm
Through-connection recommended



Hyper mini SMD-LED

Drilling plan (Elementside)

- A Fixing holes for mounting flange (84-960.0)



Libraries for the PCB layout-system p-cad 200X see : www.pcad.com/en/library Third-party Libraries

Mounting dimensions

1 Indicator actuator page 9 | Illuminated pushbutton actuator page 9 | Pushbutton actuator page 10 | Indicator actuator with ring illumination (illuminated bezel) page 10 | Pushbutton actuator with ring illumination (illuminated bezel) page 11 | Indicator actuator with ring illumination (illuminated multi-colour bezel) page 11 | Pushbutton actuator with ring illumination (illuminated multi-colour bezel) page 12



Hole spacing 31 mm min. by using blind plug 704.960.4

2 Emergency-stop pushbutton, foolproof EN IEC 60947-5-5, complete page 7 | Stop pushbutton grey, complete page 8



3 Illuminated pushbutton actuator page 9 | Pushbutton actuator page 10



Technical drawing

1 Blind plug page 16



2 Stop pushbutton enclosure page 24



3 Stop pushbutton enclosure page 24



4 Stop pushbutton enclosure page 24

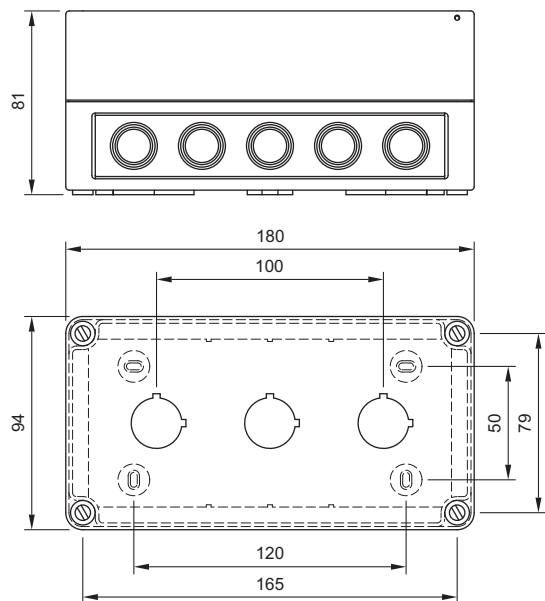

5 Stop pushbutton enclosure page 24



6 Stop pushbutton enclosure page 24



7 Legend frame page 15

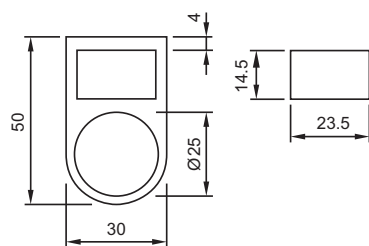

8 Blind plug page 16

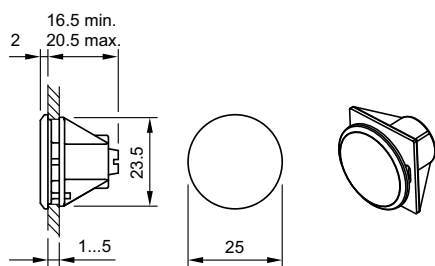

With this print version of the series 84, the panel thickness is reduced to 2.5 mm max.

9 Illumination element PCB mounting page 21



10 Mounting flange page 21



11 Emergency-stop enclosures page 24



12 Emergency-stop protective shroud page 23



13 Mounting flange page 21



14 Emergency-stop protective shroud page 23



15 Switching element PCB mounting illuminative page 21



16 Indicator actuator page 9 | Illuminated pushbutton actuator page 9 | Pushbutton actuator page 10 | Indicator actuator with ring illumination (illuminated bezel) page 10 | Pushbutton actuator with ring illumination (illuminated bezel) page 11 | Indicator actuator with ring illumination (illuminated multi-colour bezel) page 11 | Pushbutton actuator with ring illumination (illuminated multi-colour bezel) page 12

Lenses



17 Emergency-stop pushbutton, foolproof EN IEC 60947-5-5, complete page 7 | Stop pushbutton grey, complete page 8



18 Illuminated pushbutton actuator page 9 | Pushbutton actuator page 10



19 Housing, pole mounting 35 mm dia. page 25



Please note: The cut-out of the pole must read min. 22 mm dia. and needs to be aligned with the switch!

20 Housing, pole mounting 38 mm dia. page 25



Please note: The cut-out of the pole must read min. 22 mm dia. and needs to be aligned with the switch!

21 Housing, wall mounting page 26



Please note: The cut-out of the wall must read min. 22 mm dia. and needs to be aligned with the switch!

22 Adaptor, reducing to 25 mm dia. page 26

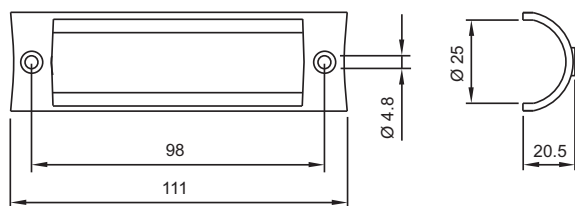

23 Adaptor, reducing to 30 mm dia. page 25

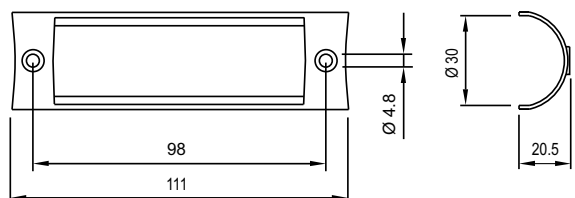

Circuit drawing

1 Illumination element with Bi-colour illumination page 18



2 Illumination element with Bi-colour illumination page 18



3 Switching element with Bi-colour illumination page 20



4 Illuminated pushbutton actuator page 9 | Pushbutton actuator page 10 | Pushbutton actuator with ring illumination (illuminated bezel) page 11 | Pushbutton actuator with ring illumination (illuminated multi-colour bezel) page 12



5 Illumination element page 17



6 Switching element non-illuminated page 20



7 Switching element illuminated page 19

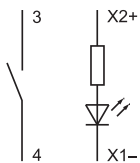

8 Emergency-stop pushbutton, foolproof EN IEC 60947-5-5, complete page 7 | Stop pushbutton grey, complete page 8



9 Emergency-stop pushbutton, foolproof EN IEC 60947-5-5, complete page 7 | Stop pushbutton grey, complete page 8



10 Emergency-stop pushbutton, foolproof EN IEC 60947-5-5, complete page 7 | Stop pushbutton grey, complete page 8



11 Emergency-stop pushbutton, foolproof EN IEC 60947-5-5, complete page 7 | Stop pushbutton grey, complete page 8



12 Emergency-stop pushbutton, foolproof EN IEC 60947-5-5, complete page 7 | Stop pushbutton grey, complete page 8



13 Emergency-stop pushbutton, foolproof EN IEC 60947-5-5, complete page 7 | Stop pushbutton grey, complete page 8



14 Switching element PCB mounting illuminative page 21



Index from Typ-Nr.

| Typ-Nr. | Page | Typ-Nr. | Page | Typ-Nr. | Page |
|---------------|------|--------------|------|--------------|------|
| 10-2602.3174D | 22 | 84-5030.0020 | 7 | 84-7124.400A | 15 |
| 10-2602.3202L | 22 | 84-5030.0040 | 7 | 84-7124.500A | 15 |
| 10-2602.3203L | 22 | 84-5031.2B20 | 7 | 84-7124.600A | 15 |
| 10-2602.3205L | 22 | 84-5031.2B40 | 7 | 84-7125.000 | 13 |
| 10-2602.3206L | 22 | 84-5040.0020 | 7 | 84-7125.800 | 13 |
| 10-2602.3209L | 22 | 84-5040.0040 | 7 | 84-7201.000 | 14 |
| 10-2603.320AL | 22 | 84-5041.2B20 | 7 | 84-7201.200 | 14 |
| 10-2603.320CL | 22 | 84-5041.2B40 | 7 | 84-7201.400 | 14 |
| 10-5609.3174D | 22 | 84-5120.0020 | 7 | 84-7201.500 | 14 |
| 31-929 | 22 | 84-5120.0040 | 7 | 84-7201.600 | 14 |
| 31-929 | 25 | 84-5121.2B20 | 7 | 84-7201.800 | 14 |
| 31-946 | 24 | 84-5121.2B40 | 7 | 84-7202.000 | 14 |
| 61-9453.0 | 16 | 84-5130.0020 | 7 | 84-7202.000A | 14 |
| 61-9481.6 | 24 | 84-5130.0040 | 7 | 84-7202.200 | 14 |
| 61-9707.7 | 13 | 84-5131.2B20 | 7 | 84-7202.200A | 14 |
| 61-9730.0 | 26 | 84-5131.2B40 | 7 | 84-7202.400 | 14 |
| 61-9980.0 | 15 | 84-5140.0020 | 7 | 84-7202.400A | 14 |
| 704.945.1 | 24 | 84-5140.0040 | 7 | 84-7202.500 | 14 |
| 704.945.2 | 24 | 84-5141.2B20 | 7 | 84-7202.500B | 14 |
| 704.945.3 | 24 | 84-5141.2B40 | 7 | 84-7202.600 | 14 |
| 704.945.4 | 24 | 84-6820.0020 | 8 | 84-7202.600A | 14 |
| 704.945.5 | 24 | 84-6820.0040 | 8 | 84-7202.800 | 14 |
| 704.945.6 | 24 | 84-6821.2B20 | 8 | 84-7202.800A | 14 |
| 704.963.0 | 23 | 84-6821.2B40 | 8 | 84-7205.000 | 14 |
| 704.963.1 | 23 | 84-6830.0020 | 8 | 84-7205.000A | 14 |
| 704.963.2 | 23 | 84-6830.0040 | 8 | 84-7205.200 | 14 |
| 704.963.3 | 23 | 84-6831.2B20 | 8 | 84-7205.200A | 14 |
| 704.963.5 | 23 | 84-6831.2B40 | 8 | 84-7205.400 | 14 |
| 704.963.6 | 23 | 84-6840.0020 | 8 | 84-7205.400A | 14 |
| 704.963.7 | 23 | 84-6840.0040 | 8 | 84-7205.500 | 14 |
| 704.963.8 | 23 | 84-6841.2B20 | 8 | 84-7205.500A | 14 |
| 704.964.8 | 16 | 84-6841.2B40 | 8 | 84-7205.600 | 14 |
| 704.968.0 | 16 | 84-7111.200 | 13 | 84-7205.600A | 14 |
| 704.968.1 | 16 | 84-7111.201 | 13 | 84-7205.800 | 14 |
| 84-0080.7 | 11 | 84-7111.202 | 13 | 84-7205.800A | 14 |
| 84-0090.7 | 10 | 84-7111.203 | 13 | 84-7211.000 | 15 |
| 84-0100.0 | 9 | 84-7111.300 | 13 | 84-7211.200 | 15 |
| 84-0200.7 | 9 | 84-7111.301 | 13 | 84-7211.400 | 15 |
| 84-1081.7 | 12 | 84-7111.400 | 13 | 84-7211.500 | 15 |
| 84-1091.7 | 11 | 84-7111.401 | 13 | 84-7211.600 | 15 |
| 84-1101.0 | 10 | 84-7111.500 | 13 | 84-7211.800 | 15 |
| 84-1101.0 | 9 | 84-7111.501 | 13 | 84-7215.000 | 15 |
| 84-1201.0 | 10 | 84-7111.502 | 13 | 84-7215.200 | 15 |
| 84-1201.0 | 9 | 84-7111.503 | 13 | 84-7215.400 | 15 |
| 84-1201.2 | 10 | 84-7111.600 | 13 | 84-7215.500 | 15 |
| 84-1201.2 | 9 | 84-7111.601 | 13 | 84-7215.600 | 15 |
| 84-1201.4 | 10 | 84-7111.602 | 13 | 84-7215.800 | 15 |
| 84-1201.4 | 9 | 84-7111.603 | 13 | 84-8001.2320 | 17 |
| 84-1201.5 | 10 | 84-7111.700 | 13 | 84-8001.2340 | 17 |
| 84-1201.5 | 9 | 84-7111.701 | 13 | 84-8001.2620 | 17 |
| 84-1201.6 | 10 | 84-7111.702 | 13 | 84-8001.2640 | 17 |
| 84-1201.6 | 9 | 84-7111.703 | 13 | 84-8001.3320 | 17 |
| 84-1201.7 | 10 | 84-7114.600A | 15 | 84-8001.3340 | 17 |
| 84-1201.7 | 9 | 84-7115.200 | 13 | 84-8001.3620 | 17 |
| 84-1221.7 | 10 | 84-7115.300 | 13 | 84-8001.3640 | 17 |
| 84-1221.7 | 9 | 84-7115.400 | 13 | 84-8001.4320 | 17 |
| 84-2101.0 | 10 | 84-7115.500 | 13 | 84-8001.4340 | 17 |
| 84-2101.0 | 9 | 84-7115.600 | 13 | 84-8001.4620 | 17 |
| 84-3100.0 | 9 | 84-7115.700 | 13 | 84-8001.4640 | 17 |
| 84-5020.0020 | 7 | 84-7121.000 | 13 | 84-8001.5320 | 17 |
| 84-5020.0040 | 7 | 84-7121.800 | 13 | 84-8001.5340 | 17 |
| 84-5021.2B20 | 7 | 84-7124.000A | 15 | 84-8001.5620 | 17 |
| 84-5021.2B40 | 7 | 84-7124.200A | 15 | 84-8001.5640 | 17 |

Index from Typ-Nr.

| Typ-Nr. | Page | Typ-Nr. | Page | Typ-Nr. | Page |
|--------------|------|------------|------|---------|------|
| 84-8001.6320 | 17 | 84-996 | 26 | | |
| 84-8001.6340 | 17 | 84-997 | 26 | | |
| 84-8001.6620 | 17 | 84-998 | 26 | | |
| 84-8001.6640 | 17 | 92-800.042 | 21 | | |
| 84-8001.9320 | 17 | 92-851.342 | 21 | | |
| 84-8001.9340 | 17 | 92-960.0 | 21 | | |
| 84-8001.9620 | 17 | | | | |
| 84-8001.9640 | 17 | | | | |
| 84-8005.7620 | 18 | | | | |
| 84-8005.7640 | 18 | | | | |
| 84-8005.8620 | 18 | | | | |
| 84-8005.8640 | 18 | | | | |
| 84-8510.0020 | 20 | | | | |
| 84-8510.0040 | 20 | | | | |
| 84-8511.2320 | 19 | | | | |
| 84-8511.2340 | 19 | | | | |
| 84-8511.2620 | 19 | | | | |
| 84-8511.2640 | 19 | | | | |
| 84-8511.3320 | 19 | | | | |
| 84-8511.3340 | 19 | | | | |
| 84-8511.3620 | 19 | | | | |
| 84-8511.3640 | 19 | | | | |
| 84-8511.4320 | 19 | | | | |
| 84-8511.4340 | 19 | | | | |
| 84-8511.4620 | 19 | | | | |
| 84-8511.4640 | 19 | | | | |
| 84-8511.5320 | 19 | | | | |
| 84-8511.5340 | 19 | | | | |
| 84-8511.5620 | 19 | | | | |
| 84-8511.5640 | 19 | | | | |
| 84-8511.6320 | 19 | | | | |
| 84-8511.6340 | 19 | | | | |
| 84-8511.6620 | 19 | | | | |
| 84-8511.6640 | 19 | | | | |
| 84-8511.9320 | 19 | | | | |
| 84-8511.9340 | 19 | | | | |
| 84-8511.9620 | 19 | | | | |
| 84-8511.9640 | 19 | | | | |
| 84-8515.7640 | 20 | | | | |
| 84-8515.8640 | 20 | | | | |
| 84-900 | 22 | | | | |
| 84-902 | 23 | | | | |
| 84-902A | 23 | | | | |
| 84-902B | 23 | | | | |
| 84-902D | 23 | | | | |
| 84-905 | 23 | | | | |
| 84-908 | 23 | | | | |
| 84-909 | 23 | | | | |
| 84-910 | 24 | | | | |
| 84-9103.7 | 15 | | | | |
| 84-9300.4 | 26 | | | | |
| 84-9300.8 | 26 | | | | |
| 84-9420 | 21 | | | | |
| 84-9500.4 | 25 | | | | |
| 84-9500.6A | 25 | | | | |
| 84-9500.8 | 25 | | | | |
| 84-960.0 | 21 | | | | |
| 84-9600.4 | 25 | | | | |
| 84-9600.8 | 25 | | | | |
| 84-9700.4 | 25 | | | | |
| 84-9700.8 | 25 | | | | |
| 84-9800.4 | 26 | | | | |
| 84-9800.8 | 26 | | | | |

| | |
|----------------|---|
| | EAO AG |
| | Tannwaldstrasse 88 4601 Olten, Switzerland |
| E-mail | info@eao.com |
| Website | www.eao.com |
| | Austria |
| Phone | +49 201 85 87 0 |
| Fax | +49 201 85 87 210 |
| E-mail | sales.ede@eao.com |
| | Belgium |
| Phone | +32 3 777 82 36 |
| Fax | +32 3 777 84 19 |
| E-mail | sales.ebl@eao.com |
| | China |
| Phone | +852 27 86 91 41 |
| Fax | +852 27 86 95 61 |
| E-mail | sales.ehk@eao.com |
| | France |
| Phone | +33 1 64 43 37 37 |
| Fax | +33 1 64 43 37 49 |
| E-mail | sales.esa@eao.com |
| | Germany |
| Phone | +49 201 85 87 0 |
| Fax | +49 201 85 87 210 |
| E-mail | sales.ede@eao.com |
| | Italy |
| Phone | +39 035 481 0189 |
| Fax | +39 035 481 3786 |
| E-mail | sales.eit@eao.com |
| | Japan |
| Phone | +81 3 5444 5411 |
| Fax | +81 3 5444 0345 |
| E-mail | sales.esj@eao.com |
| | Netherlands |
| Phone | +31 78 653 17 00 |
| Fax | +31 78 653 17 99 |
| E-mail | sales.enl@eao.com |
| | Sweden |
| Phone | +46 8 683 86 60 |
| Fax | +46 8 724 29 12 |
| E-mail | sales.esw@eao.com |
| | Switzerland |
| Phone | +41 62 388 95 00 |
| Fax | +41 62 388 95 55 |
| E-mail | sales.ech@eao.com |
| | United Kingdom |
| Phone | +44 1444 236 000 |
| Fax | +44 1444 236 641 |
| E-mail | sales.euk@eao.com |
| | USA |
| Phone | +1 203 877 4577 |
| Fax | +1 203 877 3694 |
| E-mail | sales.eus@eao.com |
| | Other Countries |
| Phone | +41 62 286 92 10 |
| Fax | +41 62 296 21 62 |
| E-mail | info@eao.com |

Компания «Life Electronics» занимается поставками электронных компонентов импортного и отечественного производства от производителей и со складов крупных дистрибьюторов Европы, Америки и Азии.

С конца 2013 года компания активно расширяет линейку поставок компонентов по направлению коаксиальный кабель, кварцевые генераторы и конденсаторы (керамические, пленочные, электролитические), за счёт заключения дистрибьюторских договоров

Мы предлагаем:

- Конкурентоспособные цены и скидки постоянным клиентам.
- Специальные условия для постоянных клиентов.
- Подбор аналогов.
- Поставку компонентов в любых объемах, удовлетворяющих вашим потребностям.
- Приемлемые сроки поставки, возможна ускоренная поставка.
- Доставку товара в любую точку России и стран СНГ.
- Комплексную поставку.
- Работу по проектам и поставку образцов.
- Формирование склада под заказчика.
- Сертификаты соответствия на поставляемую продукцию (по желанию клиента).
- Тестирование поставляемой продукции.
- Поставку компонентов, требующих военную и космическую приемку.
- Входной контроль качества.
- Наличие сертификата ISO.

В составе нашей компании организован Конструкторский отдел, призванный помогать разработчикам, и инженерам.

Конструкторский отдел помогает осуществить:

- Регистрацию проекта у производителя компонентов.
- Техническую поддержку проекта.
- Защиту от снятия компонента с производства.
- Оценку стоимости проекта по компонентам.
- Изготовление тестовой платы монтаж и пусконаладочные работы.



Тел: +7 (812) 336 43 04 (многоканальный)

Email: org@lifeelectronics.ru