

Optocoupler, Phototransistor Output, Dual Channel

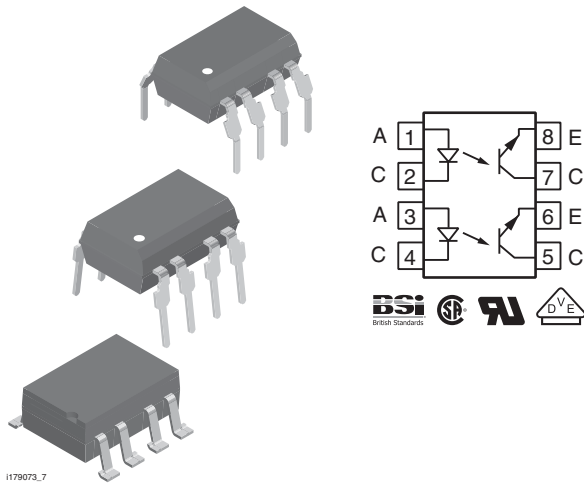

H179073_7

FEATURES

- Dual version of SFH610 series
- Isolation test voltage, 5300 V_{RMS}
- V_{CEsat} 0.25 (≤ 0.4) V at I_F = 10 mA, I_C = 2.5 mA
- V_{CEO} = 70 V
- Compliant to RoHS Directive 2002/95/EC and in accordance to WEEE 2002/96/EC

RoHS
COMPLIANT

AGENCY APPROVALS

- UL1577, file no. E52744 system code H or J, double protection
- DIN EN 60747-5-5 (VDE 0884)/DIN EN 60747-5-5 pending
- CSA 93751
- BSI IEC 60950; IEC 60065

DESCRIPTION

The ILD610 series is a dual channel optocoupler series for high density applications. Each channel consists of an optically coupled pair with a gallium arsenide infrared LED and silicon NPN phototransistor. Signal information, including a DC level, can be transmitted by the device while maintaining a high degree of electrical isolation between input and output. The ILD610 series is the dual version of SFH610 series and uses a repetitive pin-out configuration instead of the more common alternating pin-out used in most dual couplers.

ORDERING INFORMATION

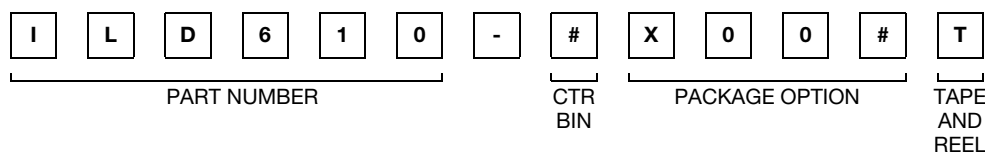

AGENCY CERTIFIED/PACKAGE	CTR (%)			
	40 to 80	63 to 125	100 to 200	160 to 320
UL, CSA, BSI	40 to 80	63 to 125	100 to 200	160 to 320
DIP-8	ILD610-1	-	ILD610-3	-
DIP-8, 400 mil, option 6	-	-	ILD610-3X006	-
SMD-8, option 7	-	ILD610-2X007T	-	-
SMD-8, option 9	-	-	ILD610-3X009	ILD610-4X009

Note

- Additional options may be possible, please contact sales office.

Vishay Semiconductors Optocoupler, Phototransistor Output, Dual Channel

ABSOLUTE MAXIMUM RATINGS ($T_{amb} = 25\text{ }^{\circ}\text{C}$, unless otherwise specified)				
PARAMETER	TEST CONDITION	SYMBOL	VALUE	UNIT
INPUT				
Reverse voltage		V_R	6.0	V
Surge forward current	$t \leq 1.0\text{ ms}$	I_{FSM}	1.5	A
Power dissipation		P_{diss}	100	mW
Derate linearly from 25 °C			1.3	mW/°C
Forward continuous current		I_F	60	mA
OUTPUT				
Collector emitter voltage		V_{CE}	70	V
Collector current		I_C	50	mA
	$t \leq 1.0\text{ ms}$	I_C	100	mA
Power dissipation		P_{diss}	150	mW
Derate linearly from 25 °C			2.0	mW/°C
COUPLER				
Isolation test voltage	$t = 1.0\text{ s}$	V_{ISO}	5300	V_{RMS}
Isolation resistance	$V_{IO} = 500\text{ V}, T_{amb} = 25\text{ }^{\circ}\text{C}$	R_{IO}	$\geq 10^{12}$	Ω
	$V_{IO} = 500\text{ V}, T_{amb} = 100\text{ }^{\circ}\text{C}$	R_{IO}	$\geq 10^{11}$	Ω
Storage temperature		T_{stg}	- 55 to + 150	°C
Operating temperature		T_{amb}	- 55 to + 100	°C
Junction temperature		T_j	100	°C
Lead soldering time at 260 °C			10	s

Note

- Stresses in excess of the absolute maximum ratings can cause permanent damage to the device. Functional operation of the device is not implied at these or any other conditions in excess of those given in the operational sections of this document. Exposure to absolute maximum ratings for extended periods of the time can adversely affect reliability.

ELECTRICAL CHARACTERISTICS ($T_{amb} = 25\text{ }^{\circ}\text{C}$, unless otherwise specified)							
PARAMETER	TEST CONDITION	PART	SYMBOL	MIN.	TYP.	MAX.	UNIT
INPUT							
Forward voltage	$I_F = 60\text{ mA}$		V_F		1.25	1.65	V
Reverse current	$V_R = 6.0\text{ V}$		I_R		0.01	10	μA
Capacitance	$V_R = 0\text{ V}, f = 1.0\text{ MHz}$		C_O		25		pF
OUTPUT							
Collector emitter breakdown voltage	$I_C = 10\text{ mA}, I_E = 10\text{ }\mu\text{A}$		BV_{CEO}	70	90		V
			BV_{CEO}	6.0	7.0		V
Collector emitter dark current	$V_{CE} = 10\text{ V}$		I_{CEO}		2.0	50	nA
Collector emitter capacitance	$V_{CE} = 5.0\text{ V}, f = 1.0\text{ MHz}$		C_{CE}		7.0		pF
Collector emitter leakage current	$V_{CE} = 10\text{ V}$	ILD610-1	I_{CEO}		2.0	50	nA
		ILD610-2	I_{CEO}		2.0	50	nA
		ILD610-3	I_{CEO}		5.0	100	nA
		ILD610-4	I_{CEO}		5.0	100	nA
COUPLER							
Collector emitter saturation voltage	$I_F = 10\text{ mA}, I_C = 2.5\text{ mA}$		V_{CEsat}		0.25	0.40	V
Coupling capacitance			C_C		0.35		pF

Note

- Minimum and maximum values are testing requirements. Typical values are characteristics of the device and are the result of engineering evaluation. Typical values are for information only and are not part of the testing requirements.



Optocoupler, Phototransistor Output, Dual Channel Vishay Semiconductors

CURRENT TRANSFER RATIO ($T_{amb} = 25\text{ }^{\circ}\text{C}$, unless otherwise specified)							
PARAMETER	TEST CONDITION	PART	SYMBOL	MIN.	TYP.	MAX.	UNIT
CTR ⁽¹⁾	$I_F = 10\text{ mA}$, $V_{CE} = 5.0\text{ V}$	ILD610-1	CTR	40		80	%
		ILD610-2	CTR	63		125	%
		ILD610-3	CTR	100		200	%
		ILD610-4	CTR	160		320	%
	$I_F = 1.0\text{ mA}$, $V_{CE} = 5.0\text{ V}$	ILD610-1	CTR	13			%
		ILD610-2	CTR	22			%
		ILD610-3	CTR	34			%
		ILD610-4	CTR	56			%

Note

⁽¹⁾ CTR will match within a ratio of 1.7:1

SWITCHING CHARACTERISTICS ($T_{amb} = 25\text{ }^{\circ}\text{C}$, unless otherwise specified)							
PARAMETER	TEST CONDITION	PART	SYMBOL	MIN.	TYP.	MAX.	UNIT
NON-SATURATED							
Rise time	$V_{CC} = 5.0\text{ V}$, $R_L = 75\text{ }\Omega$, $I_F = 10\text{ mA}$	ILD610-1	t_r		2.0		μs
		ILD610-2			2.5		
		ILD610-3			2.9		
		ILD610-4			3.3		
Fall time	$V_{CC} = 5.0\text{ V}$, $R_L = 75\text{ }\Omega$, $I_F = 10\text{ mA}$	ILD610-1	t_f		2.0		μs
		ILD610-2			2.6		
		ILD610-3			3.1		
		ILD610-4			3.5		
Turn-on time	$V_{CC} = 5.0\text{ V}$, $R_L = 75\text{ }\Omega$, $I_F = 10\text{ mA}$	ILD610-1	t_{on}		3.0		μs
		ILD610-2			3.2		
		ILD610-3			3.6		
		ILD610-4			4.1		
Turn-off time	$V_{CC} = 5.0\text{ V}$, $R_L = 75\text{ }\Omega$, $I_F = 10\text{ mA}$	ILD610-1	t_{off}		2.9		μs
		ILD610-2			3.4		
		ILD610-3			3.7		
		ILD610-4			4.1		
SATURATED							
Rise time	$V_{CC} = 5.0\text{ V}$, $R_L = 1.0\text{ k}\Omega$, $I_F = 20\text{ mA}$	ILD610-1	t_r		2.0		μs
	$V_{CC} = 5.0\text{ V}$, $R_L = 1.0\text{ k}\Omega$, $I_F = 10\text{ mA}$	ILD610-2			2.8		
	$V_{CC} = 5.0\text{ V}$, $R_L = 1.0\text{ k}\Omega$, $I_F = 10\text{ mA}$	ILD610-3			2.8		
	$V_{CC} = 5.0\text{ V}$, $R_L = 1.0\text{ k}\Omega$, $I_F = 5\text{ mA}$	ILD610-4			4.6		
Fall time	$V_{CC} = 5.0\text{ V}$, $R_L = 1.0\text{ k}\Omega$, $I_F = 20\text{ mA}$	ILD610-1	t_f		11		μs
	$V_{CC} = 5.0\text{ V}$, $R_L = 1.0\text{ k}\Omega$, $I_F = 10\text{ mA}$	ILD610-2			14		
	$V_{CC} = 5.0\text{ V}$, $R_L = 1.0\text{ k}\Omega$, $I_F = 10\text{ mA}$	ILD610-3			14		
	$V_{CC} = 5.0\text{ V}$, $R_L = 1.0\text{ k}\Omega$, $I_F = 5\text{ mA}$	ILD610-4			15		
Turn-on time	$V_{CC} = 5.0\text{ V}$, $R_L = 1.0\text{ k}\Omega$, $I_F = 20\text{ mA}$	ILD610-1	t_{on}		3.0		μs
	$V_{CC} = 5.0\text{ V}$, $R_L = 1.0\text{ k}\Omega$, $I_F = 10\text{ mA}$	ILD610-2			4.3		
	$V_{CC} = 5.0\text{ V}$, $R_L = 1.0\text{ k}\Omega$, $I_F = 10\text{ mA}$	ILD610-3			4.3		
	$V_{CC} = 5.0\text{ V}$, $R_L = 1.0\text{ k}\Omega$, $I_F = 5\text{ mA}$	ILD610-4			6.0		
Turn-off time	$V_{CC} = 5.0\text{ V}$, $R_L = 1.0\text{ k}\Omega$, $I_F = 20\text{ mA}$	ILD610-1	t_{off}		18		μs
	$V_{CC} = 5.0\text{ V}$, $R_L = 1.0\text{ k}\Omega$, $I_F = 10\text{ mA}$	ILD610-2			25		
	$V_{CC} = 5.0\text{ V}$, $R_L = 1.0\text{ k}\Omega$, $I_F = 10\text{ mA}$	ILD610-3			25		
	$V_{CC} = 5.0\text{ V}$, $R_L = 1.0\text{ k}\Omega$, $I_F = 5\text{ mA}$	ILD610-4			25		

TYPICAL CHARACTERISTICS ($T_{amb} = 25\text{ }^{\circ}\text{C}$, unless otherwise specified)

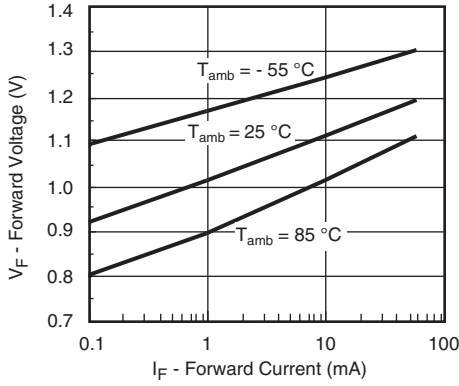

iiilct6_01

Fig. 1 - Forward Voltage vs. Forward Current

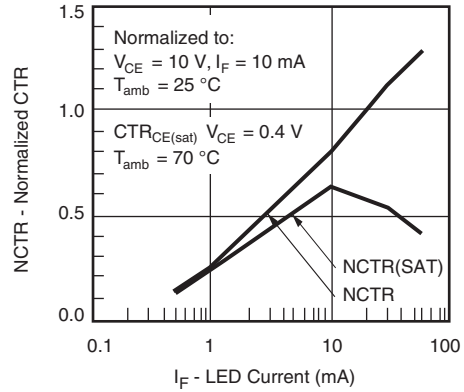

iiilct6_04

Fig. 4 - Normalized Non-Saturated and Saturated CTR vs. LED Current

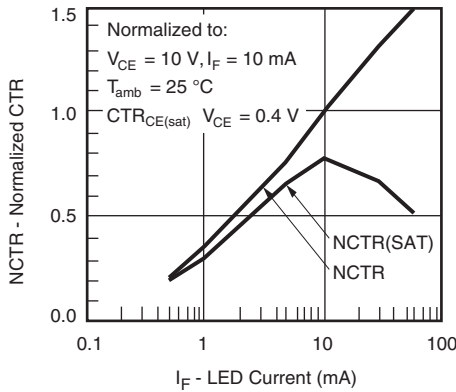

iiilct6_02

Fig. 2 - Normalized Non-Saturated and Saturated CTR vs. LED Current

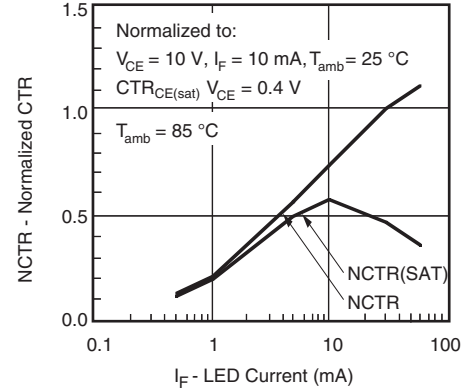

iiilct6_05

Fig. 5 - Normalized Non-Saturated and Saturated CTR vs. LED Current

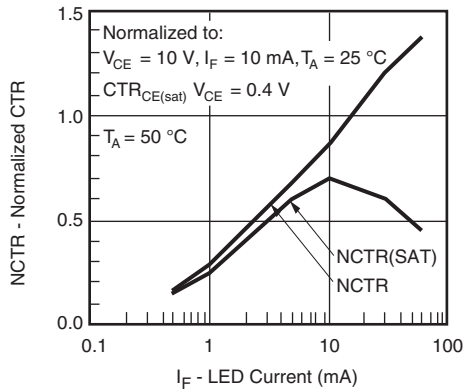

iiilct6_03

Fig. 3 - Normalized Non-Saturated and Saturated CTR vs. LED Current

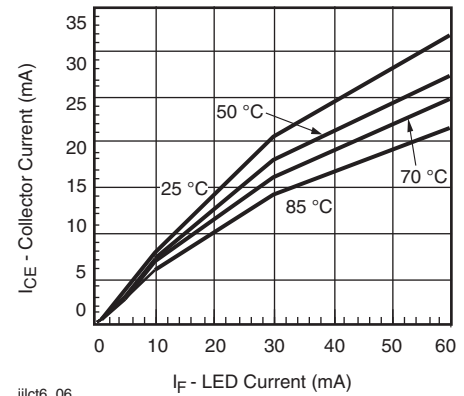

iiilct6_06

Fig. 6 - Collector Emitter Current vs. Temperature and LED Current

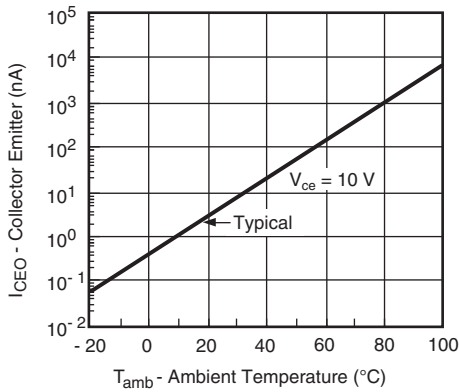

iilc6_07

Fig. 7 - Collector Emitter Leakage Current vs. Temperature

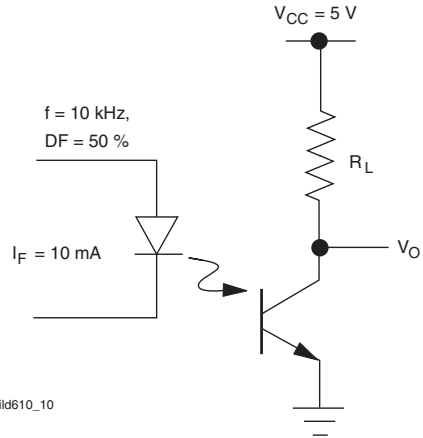

iild610_10

Fig. 10 - Non-Saturated Switching Schematic

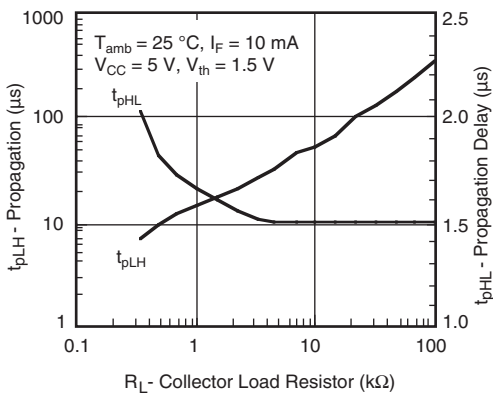

iilc6_08

Fig. 8 - Propagation Delay vs. Collector Load Resistor

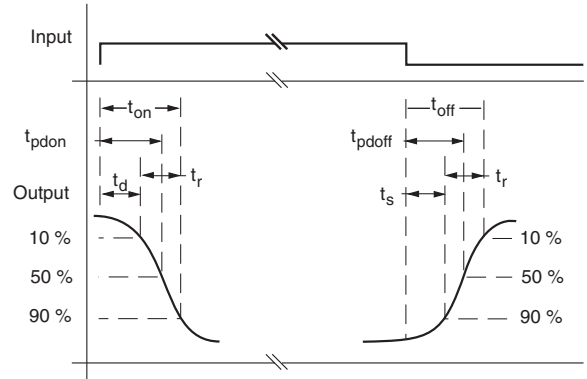

iild610_11

Fig. 11 - Saturated Switching Time Test Waveform

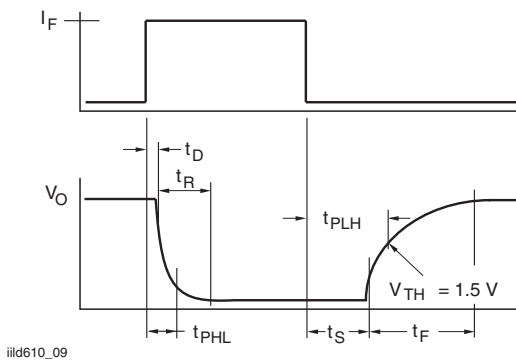

iild610_09

Fig. 9 - Switching Timing

ILD610

Vishay Semiconductors Optocoupler, Phototransistor Output, Dual Channel



PACKAGE DIMENSIONS in millimeters

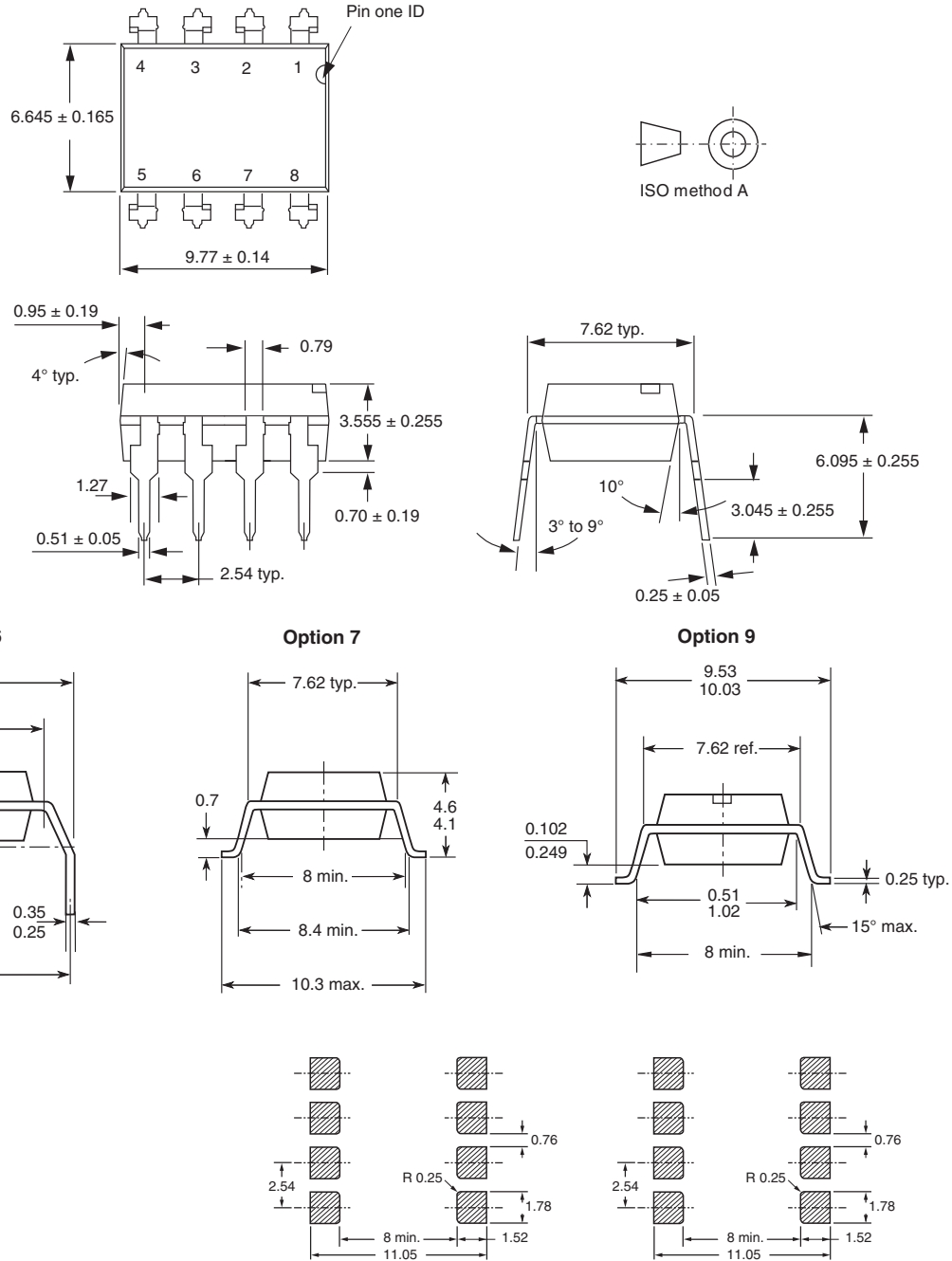

PACKAGE MARKING



Notes

- Only option 1 and 7 reflected in the package marking
- Tape and reel suffix (T) is not part of the package marking



Disclaimer

ALL PRODUCT, PRODUCT SPECIFICATIONS AND DATA ARE SUBJECT TO CHANGE WITHOUT NOTICE TO IMPROVE RELIABILITY, FUNCTION OR DESIGN OR OTHERWISE.

Vishay Intertechnology, Inc., its affiliates, agents, and employees, and all persons acting on its or their behalf (collectively, "Vishay"), disclaim any and all liability for any errors, inaccuracies or incompleteness contained in any datasheet or in any other disclosure relating to any product.

Vishay makes no warranty, representation or guarantee regarding the suitability of the products for any particular purpose or the continuing production of any product. To the maximum extent permitted by applicable law, Vishay disclaims (i) any and all liability arising out of the application or use of any product, (ii) any and all liability, including without limitation special, consequential or incidental damages, and (iii) any and all implied warranties, including warranties of fitness for particular purpose, non-infringement and merchantability.

Statements regarding the suitability of products for certain types of applications are based on Vishay's knowledge of typical requirements that are often placed on Vishay products in generic applications. Such statements are not binding statements about the suitability of products for a particular application. It is the customer's responsibility to validate that a particular product with the properties described in the product specification is suitable for use in a particular application. Parameters provided in datasheets and/or specifications may vary in different applications and performance may vary over time. All operating parameters, including typical parameters, must be validated for each customer application by the customer's technical experts. Product specifications do not expand or otherwise modify Vishay's terms and conditions of purchase, including but not limited to the warranty expressed therein.

Except as expressly indicated in writing, Vishay products are not designed for use in medical, life-saving, or life-sustaining applications or for any other application in which the failure of the Vishay product could result in personal injury or death. Customers using or selling Vishay products not expressly indicated for use in such applications do so at their own risk. Please contact authorized Vishay personnel to obtain written terms and conditions regarding products designed for such applications.

No license, express or implied, by estoppel or otherwise, to any intellectual property rights is granted by this document or by any conduct of Vishay. Product names and markings noted herein may be trademarks of their respective owners.

Material Category Policy

Vishay Intertechnology, Inc. hereby certifies that all its products that are identified as RoHS-Compliant fulfill the definitions and restrictions defined under Directive 2011/65/EU of The European Parliament and of the Council of June 8, 2011 on the restriction of the use of certain hazardous substances in electrical and electronic equipment (EEE) - recast, unless otherwise specified as non-compliant.

Please note that some Vishay documentation may still make reference to RoHS Directive 2002/95/EC. We confirm that all the products identified as being compliant to Directive 2002/95/EC conform to Directive 2011/65/EU.

Vishay Intertechnology, Inc. hereby certifies that all its products that are identified as Halogen-Free follow Halogen-Free requirements as per JEDEC JS709A standards. Please note that some Vishay documentation may still make reference to the IEC 61249-2-21 definition. We confirm that all the products identified as being compliant to IEC 61249-2-21 conform to JEDEC JS709A standards.

Компания «Life Electronics» занимается поставками электронных компонентов импортного и отечественного производства от производителей и со складов крупных дистрибьюторов Европы, Америки и Азии.

С конца 2013 года компания активно расширяет линейку поставок компонентов по направлению коаксиальный кабель, кварцевые генераторы и конденсаторы (керамические, пленочные, электролитические), за счёт заключения дистрибьюторских договоров

Мы предлагаем:

- Конкурентоспособные цены и скидки постоянным клиентам.
- Специальные условия для постоянных клиентов.
- Подбор аналогов.
- Поставку компонентов в любых объемах, удовлетворяющих вашим потребностям.
- Приемлемые сроки поставки, возможна ускоренная поставка.
- Доставку товара в любую точку России и стран СНГ.
- Комплексную поставку.
- Работу по проектам и поставку образцов.
- Формирование склада под заказчика.
- Сертификаты соответствия на поставляемую продукцию (по желанию клиента).
- Тестирование поставляемой продукции.
- Поставку компонентов, требующих военную и космическую приемку.
- Входной контроль качества.
- Наличие сертификата ISO.

В составе нашей компании организован Конструкторский отдел, призванный помогать разработчикам, и инженерам.

Конструкторский отдел помогает осуществить:

- Регистрацию проекта у производителя компонентов.
- Техническую поддержку проекта.
- Защиту от снятия компонента с производства.
- Оценку стоимости проекта по компонентам.
- Изготовление тестовой платы монтаж и пусконаладочные работы.



Тел: +7 (812) 336 43 04 (многоканальный)

Email: org@lifeelectronics.ru