

HDSP Series

Low Current Seven Segment Displays



Data Sheet

**HDSP-335x Series, HDSP-555x Series
HDSP-751x Series, HDSP-A10x Series
HDSP-A80x Series, HDSP-A90x Series
HDSP-E10x Series, HDSP-F10x Series
HDSP-G10x Series, HDSP-H10x Series
HDSP-K12x, K70x Series, HDSP-N10x Series**



Description

These low current seven segment displays are designed for applications requiring low power consumption. They are tested and selected for their excellent low current characteristics to ensure that the segments are matched at low currents. Drive currents as low as 1 mA per segment are available.

Pin for pin equivalent displays are also available in a standard current or high light ambient design. The standard current displays are available in all colors and are ideal for most applications. The high light ambient displays are ideal for sunlight ambients or long string lengths. For additional information see the 7.6 mm Micro Bright Seven Segment Displays, 10 mm Seven Segment Displays, 7.6 mm/10.9 mm Seven Segment Displays, 14.2 mm Seven Segment Displays, 20 mm Seven Segment Displays, or High Light Ambient Seven Segment Displays data sheets.

Features

- Low Power Consumption
- Industry Standard Size
- Industry Standard Pinout
- Choice of Character Size
7.6 mm (0.30 in), 10 mm (0.40 in), 10.9 mm (0.43 in), 14.2 mm (0.56 in), 20 mm (0.80 in)
- Choice of Colors
AlGaAs Red, High Efficiency Red (HER), Yellow, Green
- Excellent Appearance
Evenly Lighted Segments
 $\pm 50^\circ$ Viewing Angle
- Design Flexibility
Common Anode or Common Cathode
Single and Dual Digit
Left and Right Hand Decimal Points
 ± 1 . Overflow Character
- Categorized for Luminous Intensity
Yellow and Green Categorized for Color
Use of Like Categories Yields a Uniform Display
- Excellent for Long Digit String Multiplexing

Devices

AlGaAs HDSP-	HER HDSP-	Yellow HDSP-	Green HDSP-	Description	Package Drawing
A101	7511	A801	A901	7.6 mm Common Anode Right Hand Decimal	A
A103	7513	A803	A903	7.6 mm Common Cathode Right Hand Decimal	B
A107	7517	A807	A907	7.6 mm Common Anode ± 1 . Overflow	C
A108	7518	A808	A908	7.6 mm Common Cathode ± 1 . Overflow	D
F101				10 mm Common Anode Right Hand Decimal	E
F103				10 mm Common Cathode Right Hand Decimal	F
F107				10 mm Common Anode ± 1 . Overflow	G
F108				10 mm Common Cathode ± 1 . Overflow	H
G101				10 mm Two Digit Common Anode Right Hand Decimal	X
G103				10 mm Two Digit Common Cathode Right Hand Decimal	Y
E100	3350			10.9 mm Common Anode Left Hand Decimal	I
E101	3351			10.9 mm Common Anode Right Hand Decimal	J
E103	3353			10.9 mm Common Cathode Right Hand Decimal	K
E106	3356			10.9 mm Universal ± 1 . Overflow ^[1]	L
H101	5551			14.2 mm Common Anode Right Hand Decimal	M
H103	5553			14.2 mm Common Cathode Right Hand Decimal	N
H107	5557			14.2 mm Common Anode ± 1 . Overflow	O
H108	5558			14.2 mm Common Cathode ± 1 . Overflow	P
K121	K701			14.2 mm Two Digit Common Anode Right Hand Decimal	R
K123	K703			14.2 mm Two Digit Common Cathode Right Hand Decimal	S
N100				20 mm Common Anode Left Hand Decimal	Q
N101				20 mm Common Anode Right Hand Decimal	T
N103				20 mm Common Cathode Right Hand Decimal	U
N105				20 mm Common Cathode Left Hand Decimal	V
N106				20 mm Universal ± 1 . Overflow ^[1]	W

Note:

1. Universal pinout brings the anode and cathode of each segment's LED out to separate pins. See internal diagrams L or W.

Part Numbering System

5082 - x xx x - x x x xx

HDSP - x xx x - x x x xx



Notes:

1. For codes not listed in the figure above, please refer to the respective datasheet or contact your nearest Agilent representative for details.
2. Bin options refer to shippable bins for a part-number. Color and Intensity Bins are typically restricted to 1 bin per tube (exceptions may apply). Please refer to respective datasheet for specific bin limit information.

Package Dimensions



A, B



A, B, C, D



C, D

PIN	FUNCTION			
	A	B	C	D
1	ANODE ^[4]	CATHODE ^[5]	ANODE ^[4]	CATHODE ^[5]
2	CATHODE f	ANODE f	CATHODE PLUS	ANODE PLUS
3	CATHODE g	ANODE g	CATHODE MINUS	ANODE MINUS
4	CATHODE e	ANODE e	NC	NC
5	CATHODE d	ANODE d	NC	NC
6	ANODE ^[4]	CATHODE ^[5]	ANODE ^[4]	CATHODE ^[5]
7	CATHODE DP	ANODE DP	CATHODE DP	ANODE DP
8	CATHODE c	ANODE c	CATHODE c	ANODE c
9	CATHODE b	ANODE b	CATHODE b	ANODE b
10	CATHODE a	ANODE a	NC	NC

NOTES:

1. ALL DIMENSIONS IN MILLIMETRES (INCHES).
2. MAXIMUM.
3. ALL UNTOLERANCED DIMENSIONS ARE FOR REFERENCE ONLY.
4. REDUNDANT ANODES.
5. REDUNDANT CATHODES.

Package Dimensions (cont.)



* The Side View of package indicates Country of Origin.



PIN	FUNCTION			
	E	F	G	H
1	ANODE ⁽¹⁾	CATHODE ⁽²⁾	ANODE ⁽¹⁾	CATHODE ⁽²⁾
2	CATHODE f	ANODE f	CATHODE PLUS	ANODE PLUS
3	CATHODE g	ANODE g	CATHODE MINUS	ANODE MINUS
4	CATHODE e	ANODE e	NC	NC
5	CATHODE d	ANODE d	NC	NC
6	ANODE ⁽¹⁾	CATHODE ⁽²⁾	ANODE ⁽¹⁾	CATHODE ⁽²⁾
7	CATHODE DP	ANODE DP	CATHODE DP	ANODE DP
8	CATHODE c	ANODE c	CATHODE c	ANODE c
9	CATHODE b	ANODE b	CATHODE b	ANODE b
10	CATHODE a	ANODE a	NC	NC

NOTES:

1. ALL DIMENSIONS IN MILLIMETRES (INCHES).
2. ALL UNTOLERANCED DIMENSIONS ARE FOR REFERENCE ONLY.
3. FOR YELLOW AND GREEN SERIES PRODUCT ONLY.
4. REDUNDANT ANODES.
5. REDUNDANT CATHODES.

Package Dimensions (cont.)



I
FRONT VIEW



J, K
FRONT VIEW



SIDE VIEW

*The Side View of package indicates Country of Origin.



END VIEW

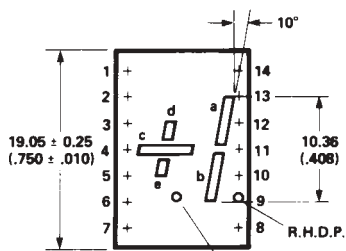

L

PIN	FUNCTION			
	I	J	K	L
1	CATHODE-a	CATHODE-a	ANODE-a	CATHODE-d
2	CATHODE-f	CATHODE-f	ANODE-f	ANODE-d
3	ANODE ^[3]	ANODE ^[3]	CATHODE ^[6]	NO PIN
4	NO PIN	NO PIN	NO PIN	CATHODE-c
5	NO PIN	NO PIN	NO PIN	CATHODE-e
6	CATHODE-dp	NO CONN. ^[5]	NO CONN. ^[5]	ANODE-e
7	CATHODE-e	CATHODE-e	ANODE-e	ANODE-c
8	CATHODE-d	CATHODE-d	ANODE-d	ANODE-dp
9	NO CONN. ^[5]	CATHODE-dp	ANODE-dp	CATHODE-dp
10	CATHODE-c	CATHODE-c	ANODE-c	CATHODE-b
11	CATHODE-g	CATHODE-g	ANODE-g	CATHODE-a
12	NO PIN	NO PIN	NO PIN	NO PIN
13	CATHODE-b	CATHODE-b	ANODE-b	ANODE-a
14	ANODE ^[3]	ANODE ^[3]	CATHODE ^[6]	ANODE-b

NOTES:

1. ALL DIMENSIONS IN MILLIMETRES (INCHES).
2. ALL UNTOLERANCED DIMENSIONS ARE FOR REFERENCE ONLY.
3. REDUNDANT ANODES.
4. UNUSED dp POSITION.
5. SEE INTERNAL CIRCUIT DIAGRAM.
6. REDUNDANT CATHODES.
7. SEE PART NUMBER TABLE FOR L.H.D.P. AND R.H.D.P. DESIGNATION.

Package Dimensions (cont.)



PIN	FUNCTION			
	M	N	O	P
1	CATHODE e	ANODE e	CATHODE c	ANODE c
2	CATHODE d	ANODE d	ANODE c, d	CATHODE c, d
3	ANODE[4]	CATHODE[5]	CATHODE b	ANODE b
4	CATHODE c	ANODE c	ANODE a, b, DP	CATHODE a, b, DP
5	CATHODE DP	ANODE DP	CATHODE DP	ANODE DP
6	CATHODE b	ANODE b	CATHODE a	ANODE a
7	CATHODE a	ANODE a	ANODE a, b, DP	CATHODE a, b, DP
8	ANODE[4]	CATHODE[5]	ANODE c, d	CATHODE c, d
9	CATHODE f	ANODE f	CATHODE d	ANODE d
10	CATHODE g	ANODE g	NO PIN	NO PIN



NOTES:

1. ALL DIMENSIONS IN MILLIMETRES (INCHES).
2. MAXIMUM.
3. ALL UNTOLERANCED DIMENSIONS ARE FOR REFERENCE ONLY.
4. REDUNDANT ANODES.
5. REDUNDANT CATHODES.

Package Dimensions (cont.)

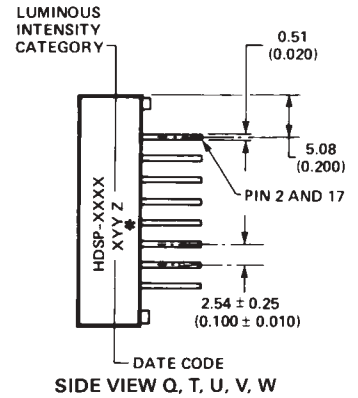

*The Side View of package indicates Country of Origin.

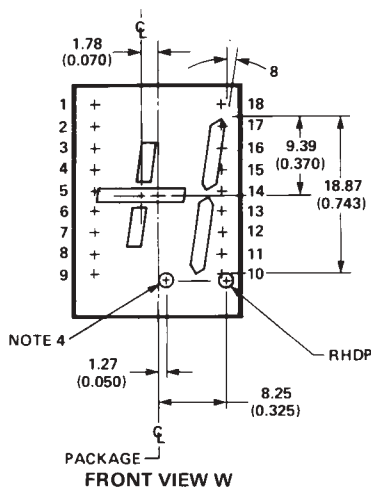

Pin	Function				
	Q	T	U	V	W
1	NO PIN	NO PIN	NO PIN	NO PIN	NO PIN
2	CATHODE a	CATHODE a	ANODE a	ANODE a	CATHODE a
3	CATHODE f	CATHODE f	ANODE f	ANODE f	ANODE d
4	ANODE ^[3]	ANODE ^[3]	CATHODE ^[6]	CATHODE ^[6]	CATHODE d
5	CATHODE e	CATHODE e	ANODE e	ANODE e	CATHODE c
6	ANODE ^[3]	ANODE ^[3]	CATHODE ^[6]	CATHODE ^[6]	CATHODE e
7	CATHODE dp	NO CONNEC.	NO CONNEC.	ANODE dp	ANODE e
8	NO PIN	NO PIN	NO PIN	NO PIN	CATHODE dp
9	NO PIN	NO PIN	NO PIN	NO PIN	NO PIN
10	NO PIN	CATHODE dp	ANODE dp	NO PIN	ANODE dp
11	CATHODE d	CATHODE d	ANODE d	ANODE d	CATHODE dp
12	ANODE ^[3]	ANODE ^[3]	CATHODE ^[6]	CATHODE ^[6]	CATHODE b
13	CATHODE c	CATHODE c	ANODE c	ANODE c	ANODE b
14	CATHODE g	CATHODE g	ANODE g	ANODE g	ANODE c
15	CATHODE b	CATHODE b	ANODE b	ANODE b	ANODE a
16	NO PIN	NO PIN	NO PIN	NO PIN	NO PIN
17	ANODE ^[3]	ANODE ^[3]	CATHODE ^[6]	CATHODE ^[6]	CATHODE a
18	NO PIN	NO PIN	NO PIN	NO PIN	NO PIN

NOTES:

- ALL DIMENSIONS IN MILLIMETRES (INCHES).
- ALL UNTOLERANCED DIMENSIONS ARE FOR REFERENCE ONLY.
- REDUNDANT ANODES.
- UNUSED dp POSITION.
- SEE INTERNAL CIRCUIT DIAGRAM.
- REDUNDANT CATHODES.
- SEE PART NUMBER TABLE FOR L.H.D.P. AND R.H.D.P. DESIGNATION.

Package Dimensions (cont.)



TOP END VIEW R, S

*The Side View of package indicates Country of Origin.



FRONT VIEW R, S



TOP END VIEW X, Y

*The Side View of package indicates Country of Origin.



FRONT VIEW X, Y

Pin	Function	
	R,X	S,Y
1	E CATHODE NO. 1	E ANODE NO. 1
2	D CATHODE NO. 1	D ANODE NO. 1
3	C CATHODE NO. 1	C ANODE NO. 1
4	DP CATHODE NO. 1	DP ANODE NO. 1
5	E CATHODE NO. 2	E ANODE NO. 2
6	D CATHODE NO. 2	D ANODE NO. 2
7	G CATHODE NO. 2	G ANODE NO. 2
8	C CATHODE NO. 2	C ANODE NO. 2
9	DP CATHODE NO. 2	DP ANODE NO. 2
10	B CATHODE NO. 2	B ANODE NO. 2
11	A CATHODE NO. 2	A ANODE NO. 2
12	F CATHODE NO. 2	F ANODE NO. 2
13	DIGIT NO. 2 ANODE	DIGIT NO. 2 CATHODE
14	DIGIT NO. 1 ANODE	DIGIT NO. 1 CATHODE
15	B CATHODE NO. 1	B ANODE NO. 1
16	A CATHODE NO. 1	A ANODE NO. 1
17	G CATHODE NO. 1	G ANODE NO. 1
18	F CATHODE NO. 1	F ANODE NO. 1

NOTES:
 1. DIMENSIONS ARE IN MILLIMETRES (INCHES).
 2. ALL UNTOLERANCED DIMENSIONS ARE FOR REFERENCE ONLY.
 3. WHERE APPLICABLE.

Internal Circuit Diagram



A, E



B, F



C, G



D, H



I



J



K



L



M



N



O

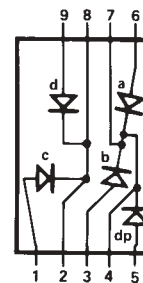

P



Q

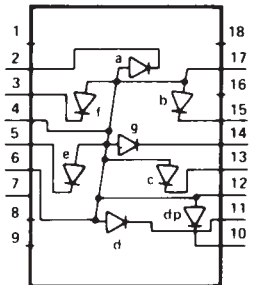

T



U

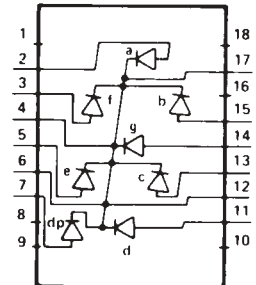

V

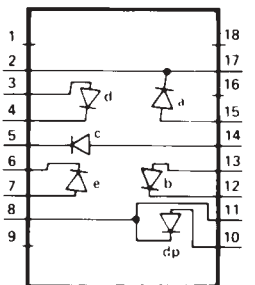

W

Internal Circuit Diagram (cont.)



HOLE PATTERN FOR PCB LAYOUT TO ACHIEVE UNIFORM 0.450 in. DIGIT TO DIGIT PITCH. FOR HDSP-FXXX TO HDSP-GXXX.

Absolute Maximum Ratings

Description	AlGaAs Red - HDSP-A10X/E10X/H10X K12X/N10X/F10X, G10X Series	HER HDSP-751X/335X/555X/K70X Series	Yellow HDSP-A80X Series	Green HDSP-A90X Series	Units
Average Power per Segment or DP	37	52	64		mW
Peak Forward Current per Segment or DP	45				mA
DC Forward Current per Segment or DP	15 ^[1]	15 ^[2]			mA
Operating Temperature Range	-20 to +100	-40 to +100			°C
Storage Temperature Range	-55 to +100				°C
Reverse Voltage per Segment or DP	3.0				V
Wave Soldering Temperature for 3 Seconds (1.60 mm [0.063 in.] below seating body)	250				°C

Notes:

1. Derate above 91°C at 0.53 mA/°C.
2. Derate HER/Yellow above 80°C at 0.38 mA/°C and Green above 71°C at 0.31 mA/°C.

Electrical/Optical Characteristics at $T_A = 25^\circ\text{C}$
AlGaAs Red

Device Series HDSP-	Parameter	Symbol	Min.	Typ.	Max.	Units	Test Conditions				
A10x	Luminous Intensity/Segment ^[1,2] (Digit Average)	I_V		315	600	μcd	$I_F = 1 \text{ mA}$				
					3600			$I_F = 5 \text{ mA}$			
F10x, G10x				330	650			$I_F = 1 \text{ mA}$			
					3900			$I_F = 5 \text{ mA}$			
E10x				390	650			$I_F = 1 \text{ mA}$			
					3900			$I_F = 5 \text{ mA}$			
H10x, K12x				400	700			$I_F = 1 \text{ mA}$			
					4200			$I_F = 5 \text{ mA}$			
N10x				270	590			$I_F = 1 \text{ mA}$			
					3500			$I_F = 5 \text{ mA}$			
All Devices				Forward Voltage/Segment or DP	V_F			1.6		V	$I_F = 1 \text{ mA}$
								1.7			$I_F = 5 \text{ mA}$
	1.8	2.2	$I_F = 20 \text{ mA Pk}$								
	Peak Wavelength	λ_{PEAK}		645		nm					
	Dominant Wavelength ^[3]	λ_d		637		nm					
Reverse Voltage/Segment or DP ^[4]	V_R	3.0	15		V	$I_R = 100 \mu\text{A}$					
	Temperature Coefficient of V_F /Segment or DP	$\Delta V_F/^\circ\text{C}$		-2 mV		mV/ $^\circ\text{C}$					
A10x	Thermal Resistance LED Junction-to-Pin	$R\theta_{\text{J-PIN}}$		255		$^\circ\text{C/W/Seg}$					
F10x, G10x				320							
E10x				340							
H10x, K12x				400							
N10x				430							

High Efficiency Red

Device Series HDSP-	Parameter	Symbol	Min.	Typ.	Max.	Units	Test Conditions
751x	Luminous Intensity/Segment ^[1,2] (Digit Average)	I _V	160	270		μcd	I _F = 2 mA
				1050			I _F = 5 mA
335x, 555x, K70x			200	300			I _F = 2 mA
				1200			I _F = 5 mA
			270	370			I _F = 2 mA
				1480			I _F = 5 mA
All Devices	Forward Voltage/Segment or DP	V _F		1.6		V	I _F = 2 mA
				1.7			I _F = 5 mA
				2.1	2.5		I _F = 20 mA Pk
	Peak Wavelength	λ _{PEAK}		635		nm	
	Dominant Wavelength ^[3]	λ _d		626		nm	
	Reverse Voltage/Segment or DP ^[4]	V _R	3.0	30		V	I _R = 100 μA
Temperature Coefficient of V _F /Segment or DP	ΔV _F /°C		-2		mV/°C		
751x	Thermal Resistance LED Junction-to-Pin	Rθ _{J-PIN}		200		°C/W	
335x				280			
555x, K70x				345			

Yellow

Device Series HDSP-	Parameter	Symbol	Min.	Typ.	Max.	Units	Test Conditions
A80x	Luminous Intensity/Segment ^[1,2] (Digit Average)	I _V	250	420		μcd	I _F = 4 mA
				1300			I _F = 10 mA
	Forward Voltage/Segment or DP	V _F		1.7		V	I _F = 4 mA
				1.8			I _F = 5 mA
				2.1	2.5		I _F = 20 mA Pk
	Peak Wavelength	λ _{PEAK}		583		nm	
	Dominant Wavelength ^[3,5]	λ _d	581.5	585	592.5	nm	
	Reverse Voltage/Segment or DP ^[4]	V _R	3.0	30		V	I _R = 100 μA
	Temperature Coefficient of V _F /Segment or DP	ΔV _F /°C		-2		mV/°C	
Thermal Resistance LED Junction-to-Pin	Rθ _{J-PIN}		200		°C/W		

Green

Device Series HDSP-	Parameter	Symbol	Min.	Typ.	Max.	Units	Test Conditions
A90x	Luminous Intensity/Segment ^[1,2] (Digit Average)	I _V	250	475		μcd	I _F = 4 mA
				1500			I _F = 10 mA
	Forward Voltage/Segment or DP	V _F		1.9		V	I _F = 4 mA
				2.0			I _F = 10 mA
				2.1	2.5		I _F = 20 mA Pk
	Peak Wavelength	λ _{PEAK}		566		nm	
	Dominant Wavelength ^[3,5]	λ _d		571	577	nm	
	Reverse Voltage/Segment or DP ^[4]	V _R	3.0	30		V	I _R = 100 μA
	Temperature Coefficient of V _F /Segment or DP	ΔV _F /°C		-2		mV/°C	
Thermal Resistance LED Junction-to-Pin	Rθ _{J-PIN}		200		°C/W		

Notes:

1. Device case temperature is 25°C prior to the intensity measurement.
2. The digits are categorized for luminous intensity. The intensity category is designated by a letter on the side of the package.
3. The dominant wavelength, λ_d, is derived from the CIE chromaticity diagram and is the single wavelength which defines the color of the device.
4. Typical specification for reference only. Do not exceed absolute maximum ratings.
5. The yellow (HDSP-A800) and Green (HDSP-A900) displays are categorized for dominant wavelength. The category is designated by a number adjacent to the luminous intensity category letter.

AlGaAs Red



Figure 1. Maximum Allowable Average or DC Current vs. Ambient Temperature.

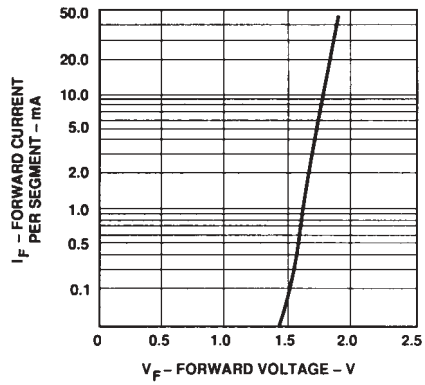

Figure 2. Forward Current vs. Forward Voltage.



Figure 3. Relative Luminous Intensity vs. DC Forward Current.

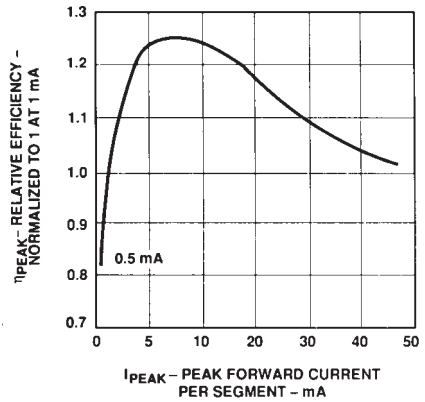

Figure 4. Relative Efficiency (Luminous Intensity per Unit Current) vs. Peak Current.

HER, Yellow, Green



Figure 5. Maximum Allowable Average or DC Current vs. Ambient Temperature.



Figure 6. Forward Current vs. Forward Voltage.



Figure 7. Relative Luminous Intensity vs. DC Forward Current.



Figure 8. Relative Efficiency (Luminous Intensity per Unit Current) vs. Peak Current.

Intensity Bin Limits (mcd)
AlGaAs Red

HDSP-A 10x		
IV Bin Category	Min.	Max.
E	0.315	0.520
F	0.428	0.759
G	0.621	1.16
H	0.945	1.71
I	1.40	2.56
J	2.10	3.84
K	3.14	5.75
L	4.70	8.55

HDSP-E10x/F10x/G10x		
IV Bin Category	Min.	Max.
D	0.391	0.650
E	0.532	0.923
F	0.755	1.39
G	1.13	2.08
H	1.70	3.14

HDSP-H10x/K12x		
IV Bin Category	Min.	Max.
C	0.415	0.690
D	0.565	0.990
E	0.810	1.50
F	1.20	2.20
G	1.80	3.30
H	2.73	5.00
I	4.09	7.50

HDSP-N10x		
IV Bin Category	Min.	Max.
A	0.270	0.400
B	0.325	0.500
C	0.415	0.690
D	0.565	0.990
E	0.810	1.50
F	1.20	2.20
G	1.80	3.30
H	2.73	5.00
I	4.09	7.50

Intensity Bin Limits (mcd), continued
HER

HDSP-751x		
IV Bin Category	Min.	Max.
B	0.160	0.240
C	0.200	0.300
D	0.250	0.385
E	0.315	0.520
F	0.428	0.759
G	0.621	1.16

HDSP-335x		
IV Bin Category	Min.	Max.
B	0.240	0.366
C	0.300	0.477
D	0.391	0.650
E	0.532	0.923
F	0.755	1.39
G	1.13	2.08
H	1.70	3.14

HDSP-555x/K70x		
IV Bin Category	Min.	Max.
A	0.270	0.400
B	0.325	0.500
C	0.415	0.690
D	0.565	0.990
E	0.810	1.50
F	1.20	2.20
G	1.80	3.30
H	2.73	5.00
I	4.09	7.50

Intensity Bin Limits (mcd), continued**Yellow**

HDSP-A 80x		
IV Bin Category	Min.	Max.
D	0.250	0.385
E	0.315	0.520
F	0.425	0.760
G	0.625	1.14
H	0.940	1.70
I	1.40	2.56
J	2.10	3.84
K	3.14	5.76
L	4.71	8.64
M	7.07	13.00
N	10.60	19.40
O	15.90	29.20
P	23.90	43.80
Q	35.80	65.60

Green

HDSP-A 90x		
IV Bin Category	Min.	Max.
E	0.315	0.520
F	0.425	0.760
G	0.625	1.14
H	0.940	1.70
I	1.40	2.56
J	2.10	3.84
K	3.14	5.76
L	4.71	8.64
M	7.07	13.00
N	10.60	19.40
O	15.90	29.20
P	23.90	43.80
Q	35.80	65.60

Color Categories

Color	Bin	Dominant Wavelength (nm)	
		Min.	Max.
Yellow	1	581.50	585.00
	3	584.00	587.50
	2	586.50	590.00
	4	589.00	592.50
Green	2	573.00	577.00
	3	570.00	574.00
	4	567.00	571.00
	5	564.00	568.00

Note:

All categories are established for classification of products. Products may not be available in all categories. Please contact your local Agilent representatives for further clarification/information.

Electrical/Optical

For more information on electrical/optical characteristics, please see Application Note 1005.

Contrast Enhancement

For information on contrast enhancement, please see Application Note 1015.

Soldering/Cleaning

Cleaning agents from the ketone family (acetone, methyl ethyl ketone, etc.) and from the chlorinated hydrocarbon family (methylene chloride, trichloroethylene, carbon tetrachloride, etc.) are not recommended for cleaning LED parts. All of these various solvents attack or dissolve the encapsulating epoxies used to form the package of plastic LED parts.

For information on soldering LEDs, please refer to Application Note 1027.

For product information and a complete list of distributors, please go to our web site: www.avagotech.com

Avago, Avago Technologies, and the A logo are trademarks of Avago Technologies, Pte. in the United States and other countries. Data subject to change. Copyright © 2006 Avago Technologies Pte. All rights reserved. Obsoletes 5989-2824EN 5989-3880EN - April 12, 2006



Компания «Life Electronics» занимается поставками электронных компонентов импортного и отечественного производства от производителей и со складов крупных дистрибьюторов Европы, Америки и Азии.

С конца 2013 года компания активно расширяет линейку поставок компонентов по направлению коаксиальный кабель, кварцевые генераторы и конденсаторы (керамические, пленочные, электролитические), за счёт заключения дистрибьюторских договоров

Мы предлагаем:

- Конкурентоспособные цены и скидки постоянным клиентам.
- Специальные условия для постоянных клиентов.
- Подбор аналогов.
- Поставку компонентов в любых объемах, удовлетворяющих вашим потребностям.
- Приемлемые сроки поставки, возможна ускоренная поставка.
- Доставку товара в любую точку России и стран СНГ.
- Комплексную поставку.
- Работу по проектам и поставку образцов.
- Формирование склада под заказчика.
- Сертификаты соответствия на поставляемую продукцию (по желанию клиента).
- Тестирование поставляемой продукции.
- Поставку компонентов, требующих военную и космическую приемку.
- Входной контроль качества.
- Наличие сертификата ISO.

В составе нашей компании организован Конструкторский отдел, призванный помогать разработчикам, и инженерам.

Конструкторский отдел помогает осуществить:

- Регистрацию проекта у производителя компонентов.
- Техническую поддержку проекта.
- Защиту от снятия компонента с производства.
- Оценку стоимости проекта по компонентам.
- Изготовление тестовой платы монтаж и пусконаладочные работы.



Тел: +7 (812) 336 43 04 (многоканальный)
Email: org@lifeelectronics.ru