



MICROCHIP MCP4901/4911/4921

8/10/12-Bit Voltage Output Digital-to-Analog Converter with SPI Interface

Features

- MCP4901: 8-Bit Voltage Output DAC
- MCP4911: 10-Bit Voltage Output DAC
- MCP4921: 12-Bit Voltage Output DAC
- Rail-to-Rail Output
- SPI Interface with 20 MHz Clock Support
- Simultaneous Latching of the DAC Output with LDAC Pin
- Fast Settling Time of 4.5 μ s
- Selectable Unity or 2x Gain Output
- External Voltage Reference Input
- External Multiplier Mode
- 2.7V to 5.5V Single-Supply Operation
- Extended Temperature Range: -40°C to +125°C

Applications

- Set Point or Offset Trimming
- Precision Selectable Voltage Reference
- Motor Control Feedback Loop
- Digitally-Controlled Multiplier/Divider
- Calibration of Optical Communication Devices

Related Products

P/N	DAC Resolution	No. of Channels	Voltage Reference (V_{REF})
MCP4801	8	1	Internal (2.048V)
MCP4811	10	1	
MCP4821	12	1	
MCP4802	8	2	
MCP4812	10	2	
MCP4822	12	2	
MCP4901	8	1	External
MCP4911	10	1	
MCP4921	12	1	
MCP4902	8	2	
MCP4912	10	2	
MCP4922	12	2	

Note: The products listed here have similar AC/DC performances.

Description

The MCP4901/4911/4921 devices are single channel 8-bit, 10-bit and 12-bit buffered voltage output Digital-to-Analog Converters (DACs), respectively. The devices operate from a single 2.7V to 5.5V supply with an SPI compatible Serial Peripheral Interface. The user can configure the full-scale range of the device to be V_{REF} or $2 \cdot V_{REF}$ by setting the gain selection option bit (gain of 1 of 2).

The user can shut down the device by setting the Configuration Register bit. In Shutdown mode, most of the internal circuits are turned off for power savings, and the output amplifier is configured to present a known high resistance output load (500 k Ω , typical).

The devices include double-buffered registers, allowing synchronous updates of the DAC output using the LDAC pin. These devices also incorporate a Power-on Reset (POR) circuit to ensure reliable power-up.

The devices utilize a resistive string architecture, with its inherent advantages of low Differential Non-Linearity (DNL) error and fast settling time. These devices are specified over the extended temperature range (+125°C).

The devices provide high accuracy and low noise performance for consumer and industrial applications where calibration or compensation of signals (such as temperature, pressure and humidity) are required.

The MCP4901/4911/4921 devices are available in the PDIP, SOIC, MSOP and DFN packages.

Package Types



MCP4901/4911/4921

Block Diagram



1.0 ELECTRICAL CHARACTERISTICS

Absolute Maximum Ratings †

V_{DD}	6.5V
All inputs and outputs w.r.t	$V_{SS} - 0.3V$ to $V_{DD} + 0.3V$
Current at Input Pins	± 2 mA
Current at Supply Pins	± 50 mA
Current at Output Pins	± 25 mA
Storage temperature	$-65^{\circ}C$ to $+150^{\circ}C$
Ambient temp. with power applied	$-55^{\circ}C$ to $+125^{\circ}C$
ESD protection on all pins	≥ 4 kV (HBM), $\geq 400V$ (MM)
Maximum Junction Temperature (T_J)	$+150^{\circ}C$

† **Notice:** Stresses above those listed under "Maximum Ratings" may cause permanent damage to the device. This is a stress rating only and functional operation of the device at those or any other conditions above those indicated in the operational listings of this specification is not implied. Exposure to maximum rating conditions for extended periods may affect device reliability.

ELECTRICAL CHARACTERISTICS

Electrical Specifications: Unless otherwise indicated, $V_{DD} = 5V$, $V_{SS} = 0V$, $V_{REF} = 2.048V$, Output Buffer Gain (G) = 2x, $R_L = 5$ k Ω to GND, $C_L = 100$ pF $T_A = -40$ to $+85^{\circ}C$. Typical values are at $+25^{\circ}C$.

Parameters	Sym	Min	Typ	Max	Units	Conditions
Power Requirements						
Operating Voltage	V_{DD}	2.7	—	5.5		
Supply Current	I_{DD}	—	175	350	μA	$V_{DD} = 5V$ $V_{DD} = 3V$ V_{REF} input is unbuffered, all digital inputs are grounded, all analog outputs (V_{OUT}) are unloaded. Code = 0x000h
		—	125	250	μA	
Software Shutdown Current	I_{SHDN_SW}	—	3.3	6	μA	Power-on Reset circuit remains on
Power-On-Reset Threshold	V_{POR}	—	2.0	—	V	
DC Accuracy						
MCP4901						
Resolution	n	8	—	—	Bits	
INL Error	INL	-1	± 0.125	1	LSb	
DNL	DNL	-0.5	± 0.1	+0.5	LSb	Note 1
MCP4911						
Resolution	n	10	—	—	Bits	
INL Error	INL	-3.5	± 0.5	3.5	LSb	
DNL	DNL	-0.5	± 0.1	+0.5	LSb	Note 1
MCP4921						
Resolution	n	12	—	—	Bits	
INL Error	INL	-12	± 2	12	LSb	
DNL	DNL	-0.75	± 0.2	+0.75	LSb	Note 1

Note 1: Guaranteed monotonic by design over all codes.

2: This parameter is ensured by design, and not 100% tested.

MCP4901/4911/4921

ELECTRICAL CHARACTERISTICS (CONTINUED)

Electrical Specifications: Unless otherwise indicated, $V_{DD} = 5V$, $V_{SS} = 0V$, $V_{REF} = 2.048V$, Output Buffer Gain (G) = 2x, $R_L = 5\text{ k}\Omega$ to GND, $C_L = 100\text{ pF}$ $T_A = -40$ to $+85^\circ\text{C}$. Typical values are at $+25^\circ\text{C}$.						
Parameters	Sym	Min	Typ	Max	Units	Conditions
Offset Error	V_{OS}	—	± 0.02	1	% of FSR	Code = 0x000h
Offset Error Temperature Coefficient	$V_{OS}/^\circ\text{C}$	—	0.16	—	ppm/ $^\circ\text{C}$	-45°C to 25°C
		—	-0.44	—	ppm/ $^\circ\text{C}$	$+25^\circ\text{C}$ to 85°C
Gain Error	g_E	—	-0.10	1	% of FSR	Code = 0xFFh, not including offset error
Gain Error Temperature Coefficient	$\Delta G/^\circ\text{C}$	—	-3	—	ppm/ $^\circ\text{C}$	
Input Amplifier (V_{REF} Input)						
Input Range – Buffered Mode	V_{REF}	0.040	—	$V_{DD} - 0.040$	V	Note 2 Code = 2048
Input Range – Unbuffered Mode	V_{REF}	0	—	V_{DD}	V	$V_{REF} = 0.2\text{ Vp-p}$, $f = 100\text{ Hz}$ and 1 kHz
Input Impedance	R_{VREF}	—	165	—	k Ω	Unbuffered Mode
Input Capacitance – Unbuffered Mode	C_{VREF}	—	7	—	pF	
Multiplier Mode -3 dB Bandwidth	f_{VREF}	—	450	—	kHz	$V_{REF} = 2.5V \pm 0.2V_{p-p}$, Unbuffered, $G = 1$
	f_{VREF}	—	400	—	kHz	$V_{REF} = 2.5V \pm 0.2V_{p-p}$, Unbuffered, $G = 2$
Multiplier Mode – Total Harmonic Distortion	THD_{VREF}	—	-73	—	dB	$V_{REF} = 2.5V \pm 0.2V_{p-p}$, Frequency = 1 kHz
Output Amplifier						
Output Swing	V_{OUT}	—	0.01 to $V_{DD} - 0.04$	—	V	Accuracy is better than 1 LSB for $V_{OUT} = 10\text{ mV}$ to $(V_{DD} - 40\text{ mV})$
Phase Margin	θ_m	—	66	—	Degrees	
Slew Rate	SR	—	0.55	—	V/ μs	
Short Circuit Current	I_{SC}	—	15	24	mA	
Settling Time	t_{settling}	—	4.5	—	μs	Within 1/2 LSB of final value from 1/4 to 3/4 full-scale range
Dynamic Performance (Note 2)						
DAC-to-DAC Crosstalk		—	10	—	nV-s	
Major Code Transition Glitch		—	45	—	nV-s	1 LSB change around major carry (0111...1111 to 1000...0000)
Digital Feedthrough		—	10	—	nV-s	
Analog Crosstalk		—	10	—	nV-s	

Note 1: Guaranteed monotonic by design over all codes.

2: This parameter is ensured by design, and not 100% tested.

ELECTRICAL CHARACTERISTIC WITH EXTENDED TEMPERATURE

Electrical Specifications: Unless otherwise indicated, $V_{DD} = 5V$, $V_{SS} = 0V$, $V_{REF} = 2.048V$, Output Buffer Gain (G) = 2x, $R_L = 5\text{ k}\Omega$ to GND, $C_L = 100\text{ pF}$. Typical values are at +125°C by characterization or simulation.

Parameters	Sym	Min	Typ	Max	Units	Conditions
Power Requirements						
Input Voltage	V_{DD}	2.7	—	5.5		
Input Current	I_{DD}	—	200	—	μA	V_{REF} input is unbuffered, all digital inputs are grounded, all analog outputs (VOUT) are unloaded. Code = 0x000h
Software Shutdown Current	I_{SHDN_SW}	—	5	—	μA	
Power-on Reset Threshold	V_{POR}	—	1.85	—	V	
DC Accuracy						
MCP4901						
Resolution	n	8	—	—	Bits	
INL Error	INL		± 0.25		LSb	
DNL	DNL		± 0.2		LSb	Note 1
MCP4911						
Resolution	n	10	—	—	Bits	
INL Error	INL		± 1		LSb	
DNL	DNL		± 0.2		LSb	Note 1
MCP4921						
Resolution	n	12	—	—	Bits	
INL Error	INL		± 4		LSb	
DNL	DNL		± 0.25		LSb	Note 1
Offset Error	V_{OS}	—	± 0.02	—	% of FSR	Code = 0x000h
Offset Error Temperature Coefficient	$V_{OS}/^{\circ}C$	—	-5	—	ppm/ $^{\circ}C$	+25°C to +125°C
Gain Error	g_E	—	-0.10	—	% of FSR	Code = 0xFFFFh, not including offset error
Gain Error Temperature Coefficient	$\Delta G/^{\circ}C$	—	-3	—	ppm/ $^{\circ}C$	
Input Amplifier (V_{REF} Input)						
Input Range – Buffered Mode	V_{REF}	—	0.040 to V_{DD} -0.040	—	V	Note 1 Code = 2048, $V_{REF} = 0.2\text{ Vp-p}$, $f = 100\text{ Hz}$ and 1 kHz
Input Range – Unbuffered Mode	V_{REF}	0	—	V_{DD}	V	
Input Impedance	R_{VREF}	—	174	—	k Ω	Unbuffered Mode
Input Capacitance – Unbuffered Mode	C_{VREF}	—	7	—	pF	
Multiplying Mode -3 dB Bandwidth	f_{VREF}	—	450	—	kHz	$V_{REF} = 2.5V \pm 0.1\text{ Vp-p}$, Unbuffered, G = 1x
	f_{VREF}	—	400	—	kHz	$V_{REF} = 2.5V \pm 0.1\text{ Vp-p}$, Unbuffered, G = 2x

Note 1: Guaranteed monotonic by design over all codes.

2: This parameter is ensured by design, and not 100% tested.

MCP4901/4911/4921

ELECTRICAL CHARACTERISTIC WITH EXTENDED TEMPERATURE (CONTINUED)

Electrical Specifications: Unless otherwise indicated, $V_{DD} = 5V$, $V_{SS} = 0V$, $V_{REF} = 2.048V$, Output Buffer Gain (G) = 2x, $R_L = 5\text{ k}\Omega$ to GND, $C_L = 100\text{ pF}$. Typical values are at +125°C by characterization or simulation.						
Parameters	Sym	Min	Typ	Max	Units	Conditions
Multiplying Mode - Total Harmonic Distortion	$THD_{V_{REF}}$	—	—	—	dB	$V_{REF} = 2.5V \pm 0.1V_{p-p}$, Frequency = 1 kHz
Output Amplifier						
Output Swing	V_{OUT}	—	0.01 to $V_{DD} - 0.04$	—	V	Accuracy is better than 1 LSB for $V_{OUT} = 10\text{ mV}$ to $(V_{DD} - 40\text{ mV})$
Phase Margin	θ_m	—	66	—	Degrees	
Slew Rate	SR	—	0.55	—	V/ μ s	
Short Circuit Current	I_{SC}	—	17	—	mA	
Settling Time	t_{settling}	—	4.5	—	μ s	Within 1/2 LSB of final value from 1/4 to 3/4 full-scale range
Dynamic Performance (Note 2)						
Major Code Transition Glitch		—	45	—	nV-s	1 LSB change around major carry (0111...1111 to 1000...0000)
Digital Feedthrough		—	10	—	nV-s	

Note 1: Guaranteed monotonic by design over all codes.

2: This parameter is ensured by design, and not 100% tested.

AC CHARACTERISTICS (SPI TIMING SPECIFICATIONS)

Electrical Specifications: Unless otherwise indicated, $V_{DD} = 2.7V - 5.5V$, $T_A = -40$ to $+125^\circ C$. Typical values are at $+25^\circ C$.

Parameters	Sym	Min	Typ	Max	Units	Conditions
Schmitt Trigger High Level Input Voltage (All digital input pins)	V_{IH}	$0.7 V_{DD}$	—	—	V	
Schmitt Trigger Low Level Input Voltage (All digital input pins)	V_{IL}	—	—	$0.2 V_{DD}$	V	
Hysteresis of Schmitt Trigger Inputs	V_{HYS}	—	$0.05 V_{DD}$	—		
Input Leakage Current	$I_{LEAKAGE}$	-1	—	1	μA	$\overline{LDAC} = \overline{CS} = \overline{SDI} = \overline{SCK} = V_{REF} = V_{DD}$ or V_{SS}
Digital Pin Capacitance (All inputs/outputs)	C_{IN}, C_{OUT}	—	10	—	pF	$V_{DD} = 5.0V$, $T_A = +25^\circ C$, $f_{CLK} = 1$ MHz (Note 1)
Clock Frequency	F_{CLK}	—	—	20	MHz	$T_A = +25^\circ C$ (Note 1)
Clock High Time	t_{HI}	15	—	—	ns	Note 1
Clock Low Time	t_{LO}	15	—	—	ns	Note 1
\overline{CS} Fall to First Rising CLK Edge	t_{CSSR}	40	—	—	ns	Applies only when \overline{CS} falls with CLK high (Note 1)
Data Input Setup Time	t_{SU}	15	—	—	ns	Note 1
Data Input Hold Time	t_{HD}	10	—	—	ns	Note 1
SCK Rise to \overline{CS} Rise Hold Time	t_{CHS}	15	—	—	ns	Note 1
\overline{CS} High Time	t_{CSH}	15	—	—	ns	Note 1
\overline{LDAC} Pulse Width	t_{LD}	100	—	—	ns	Note 1
\overline{LDAC} Setup Time	t_{LS}	40	—	—	ns	Note 1
SCK Idle Time before \overline{CS} Fall	t_{IDLE}	40	—	—	ns	Note 1

Note 1: This parameter is ensured by design and not 100% tested.



FIGURE 1-1: SPI Input Timing Data.

MCP4901/4911/4921

TEMPERATURE CHARACTERISTICS

Electrical Specifications: Unless otherwise indicated, $V_{DD} = +2.7V$ to $+5.5V$, $V_{SS} = GND$.						
Parameters	Sym	Min	Typ	Max	Units	Conditions
Temperature Ranges						
Specified Temperature Range	T_A	-40	—	+125	°C	
Operating Temperature Range	T_A	-40	—	+125	°C	Note 1
Storage Temperature Range	T_A	-65	—	+150	°C	
Thermal Package Resistances						
Thermal Resistance, 8L-DFN (2 x 3)	θ_{JA}	—	68	—	°C/W	
Thermal Resistance, 8L-PDIP	θ_{JA}	—	90	—	°C/W	
Thermal Resistance, 8L-SOIC	θ_{JA}	—	150	—	°C/W	
Thermal Resistance, 8L-MSOP	θ_{JA}	—	211	—	°C/W	

Note 1: The MCP4901/4911/4921 devices operate over this extended temperature range, but with reduced performance. Operation in this range must not cause T_J to exceed the maximum junction temperature of 150°C.

2.0 TYPICAL PERFORMANCE CURVES

Note: The graphs and tables provided following this note are a statistical summary based on a limited number of samples and are provided for informational purposes only. The performance characteristics listed herein are not tested or guaranteed. In some graphs or tables, the data presented may be outside the specified operating range (e.g., outside specified power supply range) and therefore outside the warranted range.

Note: Unless otherwise indicated, $T_A = +25^\circ\text{C}$, $V_{DD} = 5\text{V}$, $V_{SS} = 0\text{V}$, $V_{REF} = 2.048\text{V}$, Gain = 2x, $R_L = 5\text{ k}\Omega$, $C_L = 100\text{ pF}$.



FIGURE 2-1: DNL vs. Code (MCP4921).



FIGURE 2-4: Absolute DNL vs. Temperature (MCP4921).

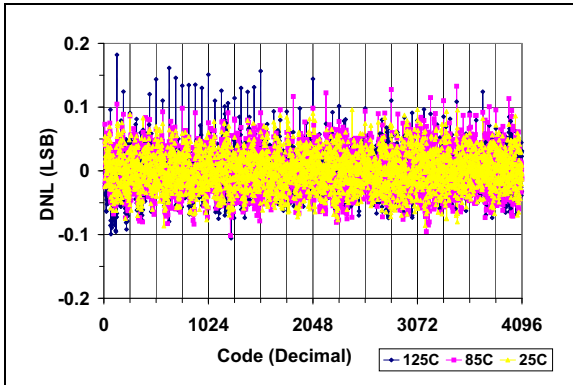

FIGURE 2-2: DNL vs. Code and Temperature (MCP4921).

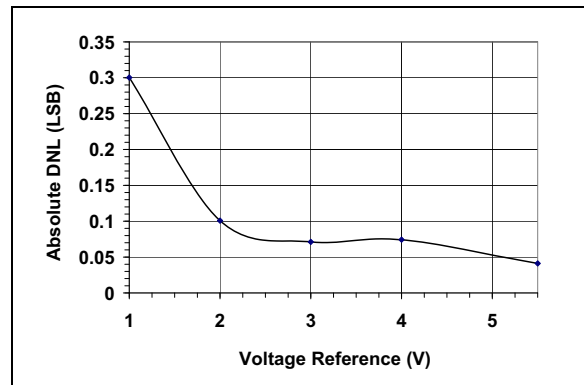

FIGURE 2-5: Absolute DNL vs. Voltage Reference (MCP4921).



FIGURE 2-3: DNL vs. Code and V_{REF} Gain=1 (MCP4921).



FIGURE 2-6: INL vs. Code and Temperature (MCP4921).

MCP4901/4911/4921

Note: Unless otherwise indicated, $T_A = +25^\circ\text{C}$, $V_{DD} = 5\text{V}$, $V_{SS} = 0\text{V}$, $V_{REF} = 2.048\text{V}$, $\text{Gain} = 2$, $R_L = 5\text{ k}\Omega$, $C_L = 100\text{ pF}$.



FIGURE 2-7: Absolute INL vs. Temperature (MCP4921).



FIGURE 2-10: INL vs. Code (MCP4921).

Note: Single device graph (Figure 2-10) for illustration of 64 code effect.



FIGURE 2-8: Absolute INL vs. V_{REF} (MCP4921).



FIGURE 2-11: DNL vs. Code and Temperature (MCP4911).



FIGURE 2-9: INL vs. Code and V_{REF} (MCP4921).



FIGURE 2-12: INL vs. Code and Temperature (MCP4911).

MCP4901/4911/4921

Note: Unless otherwise indicated, $T_A = +25^\circ\text{C}$, $V_{DD} = 5\text{V}$, $V_{SS} = 0\text{V}$, $V_{REF} = 2.048\text{V}$, Gain = 2, $R_L = 5\text{ k}\Omega$, $C_L = 100\text{ pF}$.



FIGURE 2-13: DNL vs. Code and Temperature (MCP4901).



FIGURE 2-16: I_{DD} Histogram ($V_{DD} = 2.7\text{V}$).



FIGURE 2-14: INL vs. Code and Temperature (MCP4901).



FIGURE 2-17: I_{DD} Histogram ($V_{DD} = 5.0\text{V}$).



FIGURE 2-15: I_{DD} vs. Temperature and V_{DD} .

MCP4901/4911/4921

Note: Unless otherwise indicated, $T_A = +25^\circ\text{C}$, $V_{DD} = 5\text{V}$, $V_{SS} = 0\text{V}$, $V_{REF} = 2.048\text{V}$, Gain = 2, $R_L = 5\text{ k}\Omega$, $C_L = 100\text{ pF}$.

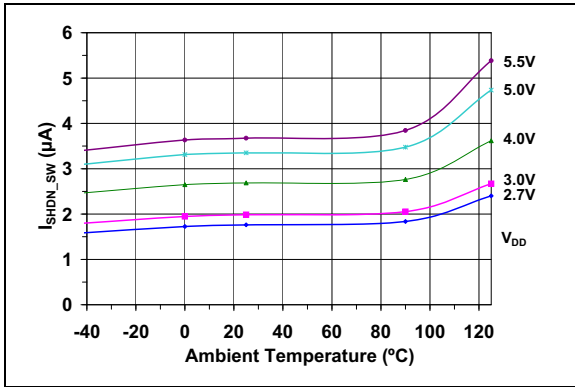

FIGURE 2-18: Shutdown Current vs. Temperature and V_{DD} .



FIGURE 2-21: V_{IN} High Threshold vs. Temperature and V_{DD} .

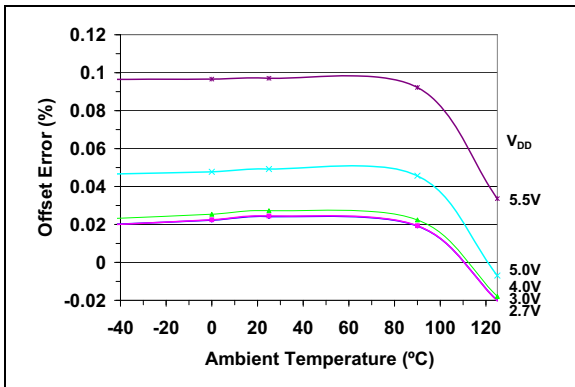

FIGURE 2-19: Offset Error vs. Temperature and V_{DD} .



FIGURE 2-22: V_{IN} Low Threshold vs. Temperature and V_{DD} .

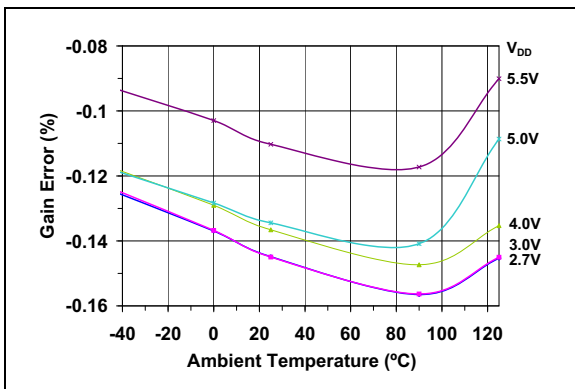

FIGURE 2-20: Gain Error vs. Temperature and V_{DD} .

MCP4901/4911/4921

Note: Unless otherwise indicated, $T_A = +25^\circ\text{C}$, $V_{DD} = 5\text{V}$, $V_{SS} = 0\text{V}$, $V_{REF} = 2.048\text{V}$, Gain = 2, $R_L = 5\text{ k}\Omega$, $C_L = 100\text{ pF}$.



FIGURE 2-23: Input Hysteresis vs. Temperature and V_{DD} .



FIGURE 2-26: V_{OUT} Low Limit vs. Temperature and V_{DD} .

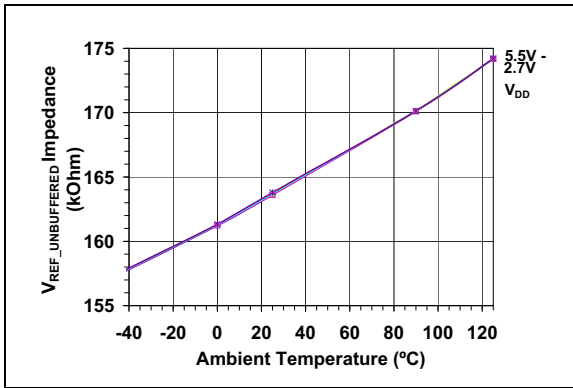

FIGURE 2-24: V_{REF} Input Impedance vs. Temperature and V_{DD} .

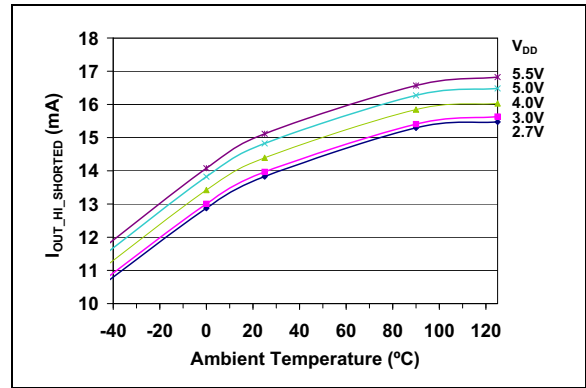

FIGURE 2-27: I_{OUT} High Short vs. Temperature and V_{DD} .



FIGURE 2-25: V_{OUT} High Limit vs. Temperature and V_{DD} .



FIGURE 2-28: I_{OUT} vs. V_{OUT} . Gain = 1.

MCP4901/4911/4921

Note: Unless otherwise indicated, $T_A = +25^\circ\text{C}$, $V_{DD} = 5\text{V}$, $V_{SS} = 0\text{V}$, $V_{REF} = 2.048\text{V}$, Gain = 2, $R_L = 5\text{ k}\Omega$, $C_L = 100\text{ pF}$.



FIGURE 2-29: V_{OUT} Rise Time



FIGURE 2-32: V_{OUT} Rise Time



FIGURE 2-30: V_{OUT} Fall Time.



FIGURE 2-33: V_{OUT} Rise Time Exit Shutdown.



FIGURE 2-31: V_{OUT} Rise Time



FIGURE 2-34: PSRR vs. Frequency.

Note: Unless otherwise indicated, $T_A = +25^\circ\text{C}$, $V_{DD} = 5\text{V}$, $V_{SS} = 0\text{V}$, $V_{REF} = 2.50\text{V}$, Gain = 2, $R_L = 5\text{ k}\Omega$, $C_L = 100\text{ pF}$.

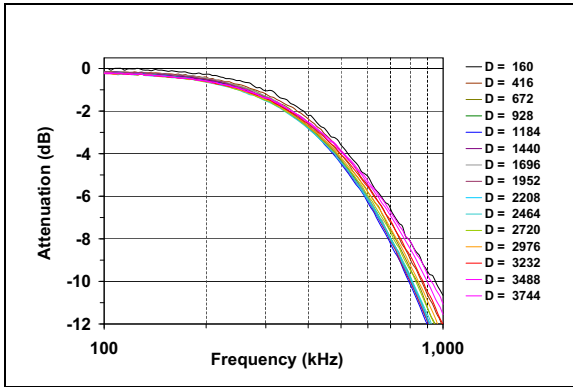

FIGURE 2-35: Multiplier Mode Bandwidth.



FIGURE 2-37: Phase Shift.

Figure 2-35 calculation:

$$\text{Attenuation (dB)} = 20 \log(V_{\text{OUT}}/V_{\text{REF}}) - 20 \log(G(D/4096))$$

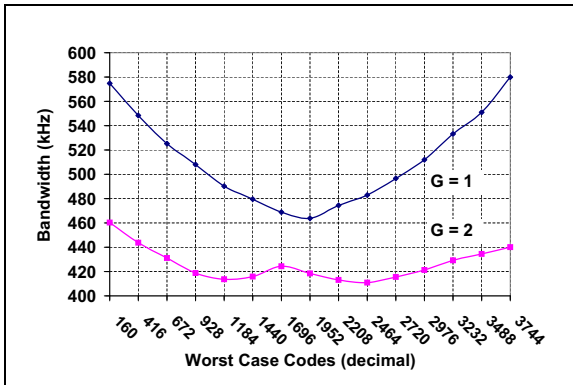

FIGURE 2-36: -3 db Bandwidth vs. Worst Codes.

MCP4901/4911/4921

NOTES:

3.0 PIN DESCRIPTIONS

The descriptions of the pins are listed in [Table 3-1](#).

TABLE 3-1: PIN FUNCTION TABLE

PDIP, MSOP, SOIC	DFN	Symbol	Description
1	1	V_{DD}	Supply Voltage Input (2.7V to 5.5V)
2	2	\overline{CS}	Chip Select Input
3	3	SCK	Serial Clock Input
4	4	SDI	Serial Data Input
5	5	\overline{LDAC}	DAC Output Synchronization Input. This pin is used to transfer the input register (DAC settings) to the output register (V_{OUT})
6	6	V_{REF}	Voltage Reference Input
7	7	V_{SS}	Ground reference point for all circuitry on the device
8	8	V_{OUT}	DAC Analog Output
—	9	EP	Exposed Thermal Pad. This pad must be connected to V_{SS} in application

3.1 Supply Voltage Pins (V_{DD} , V_{SS})

V_{DD} is the positive supply voltage input pin. The input supply voltage is relative to V_{SS} and can range from 2.7V to 5.5V. The power supply at the V_{DD} pin should be as clean as possible for good DAC performance. It is recommended to use an appropriate bypass capacitor of about 0.1 μ F (ceramic) to ground. An additional 10 μ F capacitor (tantalum) in parallel is also recommended to further attenuate high-frequency noise present in application boards.

V_{SS} is the analog ground pin and the current return path of the device. The user must connect the V_{SS} pin to a ground plane through a low-impedance connection. If an analog ground path is available in the application Printed Circuit Board (PCB), it is highly recommended that the V_{SS} pin be tied to the analog ground path or isolated within an analog ground plane of the circuit board.

3.2 Chip Select (\overline{CS})

\overline{CS} is the chip select input, which requires an active-low signal to enable serial clock and data functions.

3.3 Serial Clock Input (SCK)

SCK is the SPI compatible serial clock input.

3.4 Serial Data Input (SDI)

SDI is the SPI compatible serial data input.

3.5 Latch DAC Input (\overline{LDAC})

The \overline{LDAC} (latch DAC synchronization input) pin is used to transfer the input latch register to the DAC register (output latches, V_{OUT}). When this pin is low, V_{OUT} is updated with input register content. This pin can be tied to low (V_{SS}) if the V_{OUT} update is desired at the rising edge of the \overline{CS} pin. This pin can be driven by an external control device such as an MCU I/O pin.

3.6 Analog Output (V_{OUT})

V_{OUT} is the DAC analog output pin. The DAC output has an output amplifier. The full-scale range of the DAC output is from V_{SS} to $G \cdot V_{REF}$, where G is the gain selection option (1x or 2x). The DAC analog output cannot go higher than the supply voltage (V_{DD}).

3.7 Voltage Reference Input (V_{REF})

V_{REF} is the voltage reference input for the device. The reference on this pin is utilized to set the reference voltage on the string DAC. The input voltage can range from V_{SS} to V_{DD} . This pin can be tied to V_{DD} .

3.8 Exposed Thermal Pad (EP)

There is an internal electrical connection between the Exposed Thermal Pad (EP) and the V_{SS} pin. They must be connected to the same potential on the PCB.

MCP4901/4911/4921

NOTES:

4.0 GENERAL OVERVIEW

The MCP4901, MCP4911 and MCP4921 are single channel voltage output 8-bit, 10-bit and 12-bit DAC devices, respectively. These devices include a V_{REF} input buffer, a rail-to-rail output amplifier, shutdown and reset management circuitry. The devices use an SPI serial communication interface and operate with a single-supply voltage from 2.7V to 5.5V.

The DAC input coding of these devices is straight binary. Equation 4-1 shows the DAC analog output voltage calculation.

EQUATION 4-1: ANALOG OUTPUT VOLTAGE (V_{OUT})

$$V_{OUT} = \frac{(V_{REF} \times D_n)}{2^n} G$$

Where:

- V_{REF} = External voltage reference
- D_n = DAC input code
- G = Gain Selection
 - = 2 for $\langle \overline{GA} \rangle$ bit = 0
 - = 1 for $\langle \overline{GA} \rangle$ bit = 1
- n = DAC Resolution
 - = 8 for MCP4901
 - = 10 for MCP4911
 - = 12 for MCP4912

The ideal output range of each device is:

- **MCP4901 (n = 8)**
 - (a) 0V to $255/256 \times V_{REF}$ when gain setting = 1x.
 - (b) 0V to $255/256 \times 2 \times V_{REF}$ when gain setting = 2x.
- **MCP4911 (n = 10)**
 - (a) 0V to $1023/1024 \times V_{REF}$ when gain setting = 1x.
 - (b) 0V to $1023/1024 \times 2 \times V_{REF}$ when gain setting = 2x.
- **MCP4921 (n = 12)**
 - (a) 0V to $4095/4096 \times V_{REF}$ when gain setting = 1x.
 - (b) 0V to $4095/4096 \times 2 \times V_{REF}$ when gain setting = 2x.

Note: See the output swing voltage specification in Section 1.0 "Electrical Characteristics".

1 LSB is the ideal voltage difference between two successive codes. Table 4-1 illustrates the LSB calculation of each device.

TABLE 4-1: LSb OF EACH DEVICE

Device	Gain Selection	LSb Size
MCP4901 (n = 8)	1x	$V_{REF}/256$
	2x	$(2 \times V_{REF})/256$
MCP4911 (n = 10)	1x	$V_{REF}/1024$
	2x	$(2 \times V_{REF})/1024$
MCP4921 (n = 12)	1x	$V_{REF}/4096$
	2x	$(2 \times V_{REF})/4096$

where V_{REF} is the external voltage reference.

4.1 DC Accuracy

4.1.1 INL ACCURACY

Integral Non-Linearity (INL) error is the maximum deviation between an actual code transition point and its corresponding ideal transition point, after offset and gain errors have been removed. The two endpoints (from 0x000 and 0xFFFF) method is used for the calculation. Figure 4-1 shows the details.

A positive INL error represents transition(s) later than ideal. A negative INL error represents transition(s) earlier than ideal.



FIGURE 4-1: Example for INL Error.

4.1.2 DNL ACCURACY

A Differential Non-Linearity (DNL) error is the measure of variations in code widths from the ideal code width. A DNL error of zero indicates that every code is exactly 1 LSB wide.

MCP4901/4911/4921



FIGURE 4-2: Example for DNL Accuracy.

4.1.3 OFFSET ERROR

An offset error is the deviation from zero voltage output when the digital input code is zero.

4.1.4 GAIN ERROR

A gain error is the deviation from the ideal output, $V_{REF} - 1 \text{ LSB}$, excluding the effects of offset error.

4.2 Circuit Descriptions

4.2.1 OUTPUT AMPLIFIER

The DAC's output is buffered with a low-power, precision CMOS amplifier. This amplifier provides low offset voltage and low noise. The output stage enables the device to operate with output voltages close to the power supply rails. Refer to **Section 1.0 "Electrical Characteristics"** for the analog output voltage range and load conditions.

In addition to resistive load driving capability, the amplifier will also drive high capacitive loads without oscillation. The amplifier's strong output allows V_{OUT} to be used as a programmable voltage reference in a system.

Selecting a gain of 2 reduces the bandwidth of the amplifier in Multiplying mode. Refer to **Section 1.0 "Electrical Characteristics"** for the Multiplying mode bandwidth for given load conditions.

4.2.1.1 Programmable Gain Block

The rail-to-rail output amplifier has two configurable gain options: a gain of 1x ($\langle \overline{GA} \rangle = 1$) or a gain of 2x ($\langle \overline{GA} \rangle = 0$). The default value is a gain of 2x ($\langle \overline{GA} \rangle = 0$).

4.2.2 VOLTAGE REFERENCE AMPLIFIER

The input buffer amplifier for the MCP4901/4911/4921 devices provides low offset voltage and low noise. A Configuration bit for each DAC allows the V_{REF} input to bypass the V_{REF} input buffer amplifier, achieving Buffered or Unbuffered mode. Buffered mode provides a very high input impedance, with only minor limitations on the input range and frequency response. Unbuffered mode provides a wide input range (0V to V_{DD}), with a typical input impedance of 165 k Ω with 7 pF. Unbuffered mode ($\langle \overline{BUF} \rangle = 0$) is the default configuration.

4.2.3 POWER-ON RESET CIRCUIT

The internal Power-on Reset (POR) circuit monitors the power supply voltage (V_{DD}) during device operation. The circuit also ensures that the device powers up with high output impedance ($\langle \overline{SHDN} \rangle = 0$, typically 500 k Ω). The devices will continue to have a high-impedance output until a valid write command is received, and the \overline{LDAC} pin meets the input low threshold.

If the power supply voltage is less than the POR threshold ($V_{POR} = 2.0V$, typical), the device will be held in its Reset state. It will remain in that state until $V_{DD} > V_{POR}$ and a subsequent write command is received.

Figure 4-3 shows a typical power supply transient pulse and the duration required to cause a reset to occur, as well as the relationship between the duration and trip voltage. A 0.1 μF decoupling capacitor, mounted as close as possible to the V_{DD} pin, can provide additional transient immunity.



FIGURE 4-3: Typical Transient Response.

4.2.4 SHUTDOWN MODE

The user can shut down the device by using a software command. During Shutdown mode, most of the internal circuits, including the output amplifier, are turned off for power savings. The serial interface remains active, thus allowing a write command to bring the device out of Shutdown mode. There will be no analog output at the V_{OUT} pin, and the V_{OUT} pin is internally switched to a known resistive load (500 k Ω , typical). [Figure 4-4](#) shows the analog output stage during Shutdown mode.

The device will remain in Shutdown mode until it receives a write command with \overline{SHDN} bit = 1 and the bit is latched into the device. When the device is changed from Shutdown to Active mode, the output settling time takes less than 10 μ s, but more than the standard active mode settling time (4.5 μ s).



FIGURE 4-4: Output Stage for Shutdown Mode.

MCP4901/4911/4921

NOTES:

5.0 SERIAL INTERFACE

5.1 Overview

The MCP4901/4911/4921 devices are designed to interface directly with the Serial Peripheral Interface (SPI) port, which is available on many microcontrollers and supports Mode 0,0 and Mode 1,1. Commands and data are sent to the device via the SDI pin, with data being clocked-in on the rising edge of SCK. The communications are unidirectional, thus the data cannot be read out of the MCP4901/4911/4921. The $\overline{\text{CS}}$ pin must be held low for the duration of a write command. The write command consists of 16 bits and is used to configure the DAC's control and data latches. Register 5-1 through Register 5-3 detail the input register that is used to configure and load the DAC register for each device. Figure 5-1 through Figure 5-3 show the write command for each device.

Refer to Figure 1-1 and the SPI Timing Specifications Table for detailed input and output timing specifications for both Mode 0,0 and Mode 1,1 operation.

5.2 Write Command

The write command is initiated by driving the $\overline{\text{CS}}$ pin low, followed by clocking the four Configuration bits and the 12 data bits into the SDI pin on the rising edge of SCK. The $\overline{\text{CS}}$ pin is then raised, causing the data to be latched into the DAC's input register.

The MCP4901/4911/4921 utilizes a double-buffered latch structure to allow the analog output to be synchronized with the $\overline{\text{LDAC}}$ pin, if desired.

By bringing the $\overline{\text{LDAC}}$ pin down to a low state, the content stored in the DAC's input register is transferred into the DAC's output register (V_{OUT}), and V_{OUT} is updated.

All writes to the MCP4901/4911/4921 devices are 16-bit words. Any clocks past the 16th clock will be ignored. The Most Significant 4 bits are Configuration bits. The remaining 12 bits are data bits. No data can be transferred into the device with $\overline{\text{CS}}$ high. This transfer will only occur if 16 clocks have been transferred into the device. If the rising edge of $\overline{\text{CS}}$ occurs prior to that, shifting of data into the input register will be aborted.

MCP4901/4911/4921

REGISTER 5-1: WRITE COMMAND REGISTER FOR MCP4921 (12-BIT DAC)

W-x	W-x	W-x	W-0	W-x	W-x	W-x	W-x	W-x	W-x	W-x	W-x	W-x	W-x	W-x	W-x
0	BUF	\overline{GA}	\overline{SHDN}	D11	D10	D9	D8	D7	D6	D5	D4	D3	D2	D1	D0
bit 15								bit 0							

REGISTER 5-2: WRITE COMMAND REGISTER FOR MCP4911 (10-BIT DAC)

W-x	W-x	W-x	W-0	W-x	W-x	W-x	W-x	W-x	W-x	W-x	W-x	W-x	W-x	W-x	W-x
0	BUF	\overline{GA}	\overline{SHDN}	D9	D8	D7	D6	D5	D4	D3	D2	D1	D0	x	x
bit 15								bit 0							

REGISTER 5-3: WRITE COMMAND REGISTER FOR MCP4901 (8-BIT DAC)

W-x	W-x	W-x	W-0	W-x	W-x	W-x	W-x	W-x	W-x	W-x	W-x	W-x	W-x	W-x	W-x
0	BUF	\overline{GA}	\overline{SHDN}	D7	D6	D5	D4	D3	D2	D1	D0	x	x	x	x
bit 15								bit 0							

Where:

- bit 15 0 = Write to DAC register
 1 = Ignore this command
- bit 14 **BUF:** V_{REF} Input Buffer Control bit
 1 = Buffered
 0 = Unbuffered
- bit 13 **\overline{GA} :** Output Gain Selection bit
 1 = $1x$ ($V_{OUT} = V_{REF} * D/4096$)
 0 = $2x$ ($V_{OUT} = 2 * V_{REF} * D/4096$)
- bit 12 **\overline{SHDN} :** Output Shutdown Control bit
 1 = Active mode operation. V_{OUT} is available.
 0 = Shutdown the device. Analog output is not available. V_{OUT} pin is connected to 500 k Ω (typical).
- bit 11-0 **D11:D0:** DAC Input Data bits. Bit x is ignored.

Legend

R = Readable bit	W = Writable bit	U = Unimplemented bit, read as '0'
-n = Value at POR	1 = bit is set	0 = bit is cleared x = bit is unknown



FIGURE 5-1: Write Command for MCP4921 (12-bit DAC).



FIGURE 5-2: Write Command for MCP4911 (10-bit DAC). Note: X are don't care bits.



FIGURE 5-3: Write Command for MCP4901(8-bit DAC). Note: X are don't care bits.

MCP4901/4911/4921

NOTES:

6.0 TYPICAL APPLICATIONS

The MCP4901/4911/4921 family devices are general purpose DACs intended to be used in applications where precision with low-power and moderate bandwidth is required.

Applications generally suited for the devices are:

- Set Point or Offset Trimming
- Sensor Calibration
- Digitally-Controlled Multiplier/Divider
- Portable Instrumentation (Battery Powered)
- Motor Control Feedback Loop

6.1 Digital Interface

The MCP4901/4911/4921 devices utilize a 3-wire synchronous serial protocol to transfer the DAC's setup and output values from the digital source. The serial protocol can be interfaced to SPI or Microwire peripherals that are common on many microcontrollers, including Microchip's PIC[®] MCUs and dsPIC[®] DSCs.

In addition to the three serial connections (\overline{CS} , SCK and SDI), the \overline{LDAC} pin synchronizes the analog output (V_{OUT}) with the pin event. By bringing the \overline{LDAC} pin down "low", the DAC input code and settings in the input register are latched into the output register, and the analog output is updated. Figure 6-1 shows an example of the pin connections. Note that the \overline{LDAC} pin can be tied low (V_{SS}) to reduce the required connections from 4 to 3 I/O pins. In this case, the DAC output can be immediately updated when a valid 16-clock transmission has been received and \overline{CS} pin has been raised.

6.2 Power Supply Considerations

The typical application will require a bypass capacitor in order to filter high-frequency noise. The noise can be induced onto the power supply's traces from various events such as digital switching or as a result of changes on the DAC's output. The bypass capacitor helps to minimize the effect of these noise sources. Figure 6-1 illustrates an appropriate bypass strategy. In this example, two bypass capacitors are used in parallel: (a) 0.1 μF (ceramic) and (b) 10 μF (tantalum). These capacitors should be placed as close to the device power pin (V_{DD}) as possible (within 4 mm).

The power source supplying these devices should be as clean as possible. If the application circuit has separate digital and analog power supplies, V_{DD} and V_{SS} should reside on the analog plane.



FIGURE 6-1: Typical Connection Diagram.

6.3 Layout Considerations

Inductively-coupled AC transients and digital switching noises can degrade the input and output signal integrity, potentially reducing the device's performance. Careful board layout will minimize these effects and increase the Signal-to-Noise Ratio (SNR). Bench testing has shown that a multi-layer board utilizing a low-inductance ground plane, isolated inputs, and isolated outputs with proper decoupling, is critical for best performance. Particularly harsh environments may require shielding of critical signals.

Breadboards and wire-wrapped boards are not recommended if low noise is desired.

MCP4901/4911/4921

6.4 Single-Supply Operation

The MCP4901/4911/4921 devices are rail-to-rail voltage output DAC devices designed to operate with a V_{DD} range of 2.7V to 5.5V. Its output amplifier is robust enough to drive small signal loads directly. Therefore, it does not require an external output buffer for most applications.

6.4.1 DC SET POINT OR CALIBRATION

A common application for DAC devices is digitally-controlled set points and/or calibration of variable parameters, such as sensor offset or slope. For example, the MCP4921 and MCP4922 provide 4096 output steps. If the external voltage reference (V_{REF}) is 4.096V, the LSB size is 1 mV. If a smaller output step size is desired, a lower external voltage reference is needed.

6.4.1.1 Decreasing Output Step Size

If the application is calibrating the bias voltage of a diode or transistor, a bias voltage range of 0.8V may be desired with about 200 μ V resolution per step. Two common methods to achieve a 0.8V range is to either reduce V_{REF} to 0.82V or use a voltage divider on the DAC's output.

Using a V_{REF} is an option if the V_{REF} is available with the desired output voltage range. However, occasionally, when using a low-voltage V_{REF} , the noise floor causes an SNR error that is intolerable. Using a voltage divider method is another option and provides some advantages when V_{REF} needs to be very low or when the desired output voltage is not available. In this case, a larger value V_{REF} is used while two resistors scale the output range down to the precise desired level.

Example 6-1 illustrates this concept. Note that the bypass capacitor on the output of the voltage divider plays a critical function in attenuating the output noise of the DAC and the induced noise from the environment.



EXAMPLE 6-1: EXAMPLE CIRCUIT OF SET POINT OR THRESHOLD CALIBRATION.

6.4.1.2 Building a “Window” DAC

When calibrating a set point or threshold of a sensor, typically only a small portion of the DAC output range is utilized. If the LSb size is adequate enough to meet the application’s accuracy needs, the unused range is sacrificed without consequences. If greater accuracy is needed, then the output range will need to be reduced to increase the resolution around the desired threshold.

If the threshold is not near V_{REF} or V_{SS} , then creating a “window” around the threshold has several advantages. One simple method to create this “window” is to use a voltage divider network with a pull-up and pull-down resistor. [Example 6-2](#) and [Example 6-4](#) illustrate this concept.



EXAMPLE 6-2: SINGLE-SUPPLY “WINDOW” DAC.

MCP4901/4911/4921

6.5 Bipolar Operation

Bipolar operation is achievable using the MCP4901/4911/4921 family devices by using an external operational amplifier (op amp). This configuration is desirable due to the wide variety and availability of op amps. This allows a general purpose DAC, with its cost and availability advantages, to meet almost any desired output voltage range, power and noise performance.

Example 6-3 illustrates a simple bipolar voltage source configuration. R_1 and R_2 allow the gain to be selected, while R_3 and R_4 shift the DAC's output to a selected offset. Note that R_4 can be tied to V_{REF} instead of V_{SS} if a higher offset is desired. Note that a pull-up to V_{REF} could be used, instead of R_4 , if a higher offset is desired.

(a) Single Output DAC:
MCP4901
MCP4911
MCP4921

(b) Dual Output DAC:
MCP4902
MCP4912
MCP4922

$V_{OUT} = V_{REF} \cdot G \cdot \frac{D_n}{2^N}$

$V_{IN+} = \frac{V_{OUT}R_4}{R_3 + R_4}$

$V_O = V_{IN+} \left(1 + \frac{R_2}{R_1} \right) - V_{DD} \left(\frac{R_2}{R_1} \right)$

G = Gain selection (1x or 2x)
 D_n = Digital value of DAC (0 – 255) for MCP4901/MCP4902
 = Digital value of DAC (0 – 1023) for MCP4911/MCP4912
 = Digital value of DAC (0 – 4095) for MCP4921/MCP4922
 N = DAC Bit Resolution

EXAMPLE 6-3: DIGITALLY-CONTROLLED BIPOLAR VOLTAGE SOURCE.

6.5.1 DESIGN EXAMPLE: DESIGN A BIPOLAR DAC USING EXAMPLE 6-3 WITH 12-BIT MCP4912 OR MCP4922

An output step magnitude of 1 mV with an output range of $\pm 2.05V$ is desired for a particular application. The following steps show the details:

1. Calculate the range: $+2.05V - (-2.05V) = 4.1V$.
2. Calculate the resolution needed:
 $4.1V / 1 \text{ mV} = 4100$
 Since $2^{12} = 4096$, 12-bit resolution is desired.
3. The amplifier gain (R_2/R_1), multiplied by V_{REF} , must be equal to the desired minimum output to achieve bipolar operation. Since any gain can be realized by choosing resistor values ($R_1 + R_2$), the V_{REF} source needs to be determined first. If a V_{REF} of 4.1V is used, solve for the gain by setting the DAC to 0, knowing that the output needs to be -2.05V. The equation can be simplified to:

$$\frac{-R_2}{R_1} = \frac{-2.05}{V_{REF}} = \frac{-2.05}{4.1} \quad \frac{R_2}{R_1} = \frac{1}{2}$$

If $R_1 = 20 \text{ k}\Omega$ and $R_2 = 10 \text{ k}\Omega$, the gain will be 0.5

4. Next, solve for R_3 and R_4 by setting the DAC to 4096, knowing that the output needs to be +2.05V.

$$\frac{R_4}{(R_3 + R_4)} = \frac{2.05V + 0.5V_{REF}}{1.5V_{REF}} = \frac{2}{3}$$

If $R_4 = 20 \text{ k}\Omega$, then $R_3 = 10 \text{ k}\Omega$

6.6 Selectable Gain and Offset Bipolar Voltage Output Using DAC Devices

In some applications, precision digital control of the output range is desirable. [Example 6-4](#) illustrates how to use the DAC devices to achieve this in a bipolar or single-supply application.

This circuit is typically used in Multiplier mode and is ideal for linearizing a sensor whose slope and offset varies. Refer to [Section 6.9 “Using Multiplier Mode”](#) for more information on Multiplier mode.

The equation to design a bipolar “window” DAC would be utilized if R_3 , R_4 and R_5 are populated.



EXAMPLE 6-4: BIPOLAR VOLTAGE SOURCE WITH SELECTABLE GAIN AND OFFSET.

MCP4901/4911/4921

6.7 Designing a Double-Precision DAC

Example 6-5 illustrates how to design a single-supply voltage output capable of up to 24-bit resolution by using 12-bit DACs. This design is simply a voltage divider with a buffered output.

As an example, if a similar application to the one developed in Section 6.5.1 “Design Example: Design a bipolar dac using example 6-3 with 12-bit MCP4912 or MCP4922” required a resolution of 1 μ V instead of 1 mV and a range of 0V to 4.1V, then 12-bit resolution would not be adequate.

1. Calculate the resolution needed:
 $4.1V/1 \mu V = 4.1 \times 10^6$. Since $2^{22} = 4.2 \times 10^6$, 22-bit resolution is desired. Since $DNL = \pm 0.75$ LSB, this design can be done with the MCP4921 or MCP4922.
2. Since the DAC_B's V_{OUTB} has a resolution of 1 mV, its output only needs to be “pulled” 1/1000 to meet the 1 μ V target. Dividing V_{OUTA} by 1000 would allow the application to compensate for DAC_B's DNL error.
3. If R_2 is 100 Ω , then R_1 needs to be 100 k Ω .
4. The resulting transfer function is not perfectly linear, as shown in the equation of Example 6-5.



EXAMPLE 6-5: SIMPLE, DOUBLE PRECISION DAC WITH MCP4921 OR MCP4922.

6.8 Building Programmable Current Source

Example 6-6 shows an example for building a programmable current source using a voltage follower. The current sensor (sensor resistor) is used to convert the DAC voltage output into a digitally-selectable current source.

Adding the resistor network from **Example 6-2** would be advantageous in this application. The smaller R_{sense} is, the less power is dissipated across it. However, this also reduces the resolution that the current can be controlled with. The voltage divider, or “window”, DAC configuration would allow the range to be reduced, thus increasing the resolution around the range of interest.

When working with very small sensor voltages, plan on eliminating the amplifier's offset error by storing the DAC's setting under known sensor conditions.



EXAMPLE 6-6: DIGITALLY-CONTROLLED CURRENT SOURCE.

MCP4901/4911/4921

6.9 Using Multiplier Mode

The MCP4901/4911/4921 and MCP4902/MCP4912/MCP4922 family devices use external reference, and these devices are ideally suited for use as a multiplier/divider in a signal chain. Common applications are: (a) precision programmable gain/attenuator amplifiers and (b) motor control feedback loops. The wide input range ($0V - V_{DD}$) is in Unbuffered mode, and near rail-to-rail range in Buffered mode. Its bandwidth (> 400 kHz), selectable 1x/2x gain and low power consumption give maximum flexibility to meet the application's needs.

To configure the device for multiplier applications, connect the input signal to V_{REF} and serially configure the DAC's input buffer, gain and output value. The DAC's output can utilize any of the examples from 6-1 to 6-6, depending on the application requirements. [Example 6-7](#) is an illustration of how the DAC can operate in a motor control feedback loop.

If the gain selection bit is configured for 1x mode ($\langle \overline{GA} \rangle = 1$), the resulting input signal will be attenuated by $D/2^n$. With the 12-bit DAC (MCP4921 or MCP4922), if the gain is configured for 2x mode ($\langle \overline{GA} \rangle = 0$), codes less than 2048 attenuate the signal, while codes greater than 2048 gain the signal.

A DAC provides significantly more gain/attenuation resolution when compared to typical programmable gain amplifiers. Adding an op amp to buffer the output, as illustrated in Examples 6-2 through 6-6, extends the output range and power to meet the precise needs of the application.



EXAMPLE 6-7: MULTIPLIER MODE USING V_{REF} INPUT.

7.0 DEVELOPMENT SUPPORT

7.1 Evaluation & Demonstration Boards

The Mixed Signal PICtail™ Board supports the MCP4901/4911/4921 family of devices. Please refer to www.microchip.com for further information on this product's capabilities and availability.

MCP4901/4911/4921

NOTES:

8.0 PACKAGING INFORMATION

8.1 Package Marking Information

8-Lead DFN (2x3)



Example:



8-Lead MSOP



Example:

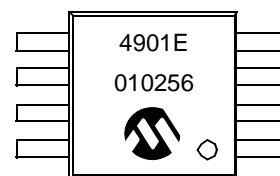

8-Lead PDIP (300 mil)



Example:

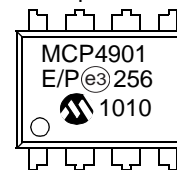

8-Lead SOIC (150 mil)



Example:

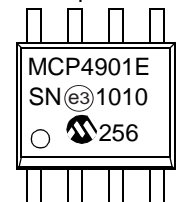

Legend:	XX...X	Customer-specific information
	Y	Year code (last digit of calendar year)
	YY	Year code (last 2 digits of calendar year)
	WW	Week code (week of January 1 is week '01')
	NNN	Alphanumeric traceability code
	(e3)	Pb-free JEDEC designator for Matte Tin (Sn)
	*	This package is Pb-free. The Pb-free JEDEC designator (e3) can be found on the outer packaging for this package.

Note: In the event the full Microchip part number cannot be marked on one line, it will be carried over to the next line, thus limiting the number of available characters for customer-specific information.

MCP4901/4911/4921

8-Lead Plastic Dual Flat, No Lead Package (MC) – 2x3x0.9 mm Body [DFN]

Note: For the most current package drawings, please see the Microchip Packaging Specification located at <http://www.microchip.com/packaging>



Dimension Limits	Units	MILLIMETERS		
		MIN	NOM	MAX
Number of Pins	N	8		
Pitch	e	0.50 BSC		
Overall Height	A	0.80	0.90	1.00
Standoff	A1	0.00	0.02	0.05
Contact Thickness	A3	0.20 REF		
Overall Length	D	2.00 BSC		
Overall Width	E	3.00 BSC		
Exposed Pad Length	D2	1.30	–	1.55
Exposed Pad Width	E2	1.50	–	1.75
Contact Width	b	0.20	0.25	0.30
Contact Length	L	0.30	0.40	0.50
Contact-to-Exposed Pad	K	0.20	–	–

Notes:

- Pin 1 visual index feature may vary, but must be located within the hatched area.
- Package may have one or more exposed tie bars at ends.
- Package is saw singulated.
- Dimensioning and tolerancing per ASME Y14.5M.

BSC: Basic Dimension. Theoretically exact value shown without tolerances.

REF: Reference Dimension, usually without tolerance, for information purposes only.

Microchip Technology Drawing C04-123C

8-Lead Plastic Dual Flat, No Lead Package (MC) – 2x3x0.9 mm Body [DFN]

Note: For the most current package drawings, please see the Microchip Packaging Specification located at <http://www.microchip.com/packaging>



RECOMMENDED LAND PATTERN

		Units	MILLIMETERS		
Dimension Limits			MIN	NOM	MAX
Contact Pitch	E		0.50 BSC		
Optional Center Pad Width	W2				1.45
Optional Center Pad Length	T2				1.75
Contact Pad Spacing	C1			2.90	
Contact Pad Width (X8)	X1				0.30
Contact Pad Length (X8)	Y1				0.75
Distance Between Pads	G	0.20			

Notes:

1. Dimensioning and tolerancing per ASME Y14.5M

BSC: Basic Dimension. Theoretically exact value shown without tolerances.

Microchip Technology Drawing No. C04-2123A

MCP4901/4911/4921

8-Lead Plastic Micro Small Outline Package (MS) [MSOP]

Note: For the most current package drawings, please see the Microchip Packaging Specification located at <http://www.microchip.com/packaging>



Dimension Limits	Units	MILLIMETERS		
		MIN	NOM	MAX
Number of Pins	N	8		
Pitch	e	0.65 BSC		
Overall Height	A	–	–	1.10
Molded Package Thickness	A2	0.75	0.85	0.95
Standoff	A1	0.00	–	0.15
Overall Width	E	4.90 BSC		
Molded Package Width	E1	3.00 BSC		
Overall Length	D	3.00 BSC		
Foot Length	L	0.40	0.60	0.80
Footprint	L1	0.95 REF		
Foot Angle	ϕ	0°	–	8°
Lead Thickness	c	0.08	–	0.23
Lead Width	b	0.22	–	0.40

Notes:

- Pin 1 visual index feature may vary, but must be located within the hatched area.
- Dimensions D and E1 do not include mold flash or protrusions. Mold flash or protrusions shall not exceed 0.15 mm per side.
- Dimensioning and tolerancing per ASME Y14.5M.

BSC: Basic Dimension. Theoretically exact value shown without tolerances.

REF: Reference Dimension, usually without tolerance, for information purposes only.

Microchip Technology Drawing C04-111B

MCP4901/4911/4921

8-Lead Plastic Micro Small Outline Package (MS) [MSOP]

Note: For the most current package drawings, please see the Microchip Packaging Specification located at <http://www.microchip.com/packaging>



RECOMMENDED LAND PATTERN

Dimension Limits	Units	MILLIMETERS		
		MIN	NOM	MAX
Contact Pitch	E	0.65 BSC		
Contact Pad Spacing	C		4.40	
Overall Width	Z			5.85
Contact Pad Width (X8)	X1			0.45
Contact Pad Length (X8)	Y1			1.45
Distance Between Pads	G1	2.95		
Distance Between Pads	GX	0.20		

Notes:

1. Dimensioning and tolerancing per ASME Y14.5M

BSC: Basic Dimension. Theoretically exact value shown without tolerances.

Microchip Technology Drawing No. C04-2111A

MCP4901/4911/4921

8-Lead Plastic Small Outline (SN) – Narrow, 3.90 mm Body [SOIC]

Note: For the most current package drawings, please see the Microchip Packaging Specification located at <http://www.microchip.com/packaging>



Dimension Limits	Units	MILLIMETERS		
		MIN	NOM	MAX
Number of Pins	N	8		
Pitch	e	1.27 BSC		
Overall Height	A	–	–	1.75
Molded Package Thickness	A2	1.25	–	–
Standoff §	A1	0.10	–	0.25
Overall Width	E	6.00 BSC		
Molded Package Width	E1	3.90 BSC		
Overall Length	D	4.90 BSC		
Chamfer (optional)	h	0.25	–	0.50
Foot Length	L	0.40	–	1.27
Footprint	L1	1.04 REF		
Foot Angle	ϕ	0°	–	8°
Lead Thickness	c	0.17	–	0.25
Lead Width	b	0.31	–	0.51
Mold Draft Angle Top	α	5°	–	15°
Mold Draft Angle Bottom	β	5°	–	15°

Notes:

- Pin 1 visual index feature may vary, but must be located within the hatched area.
- § Significant Characteristic.
- Dimensions D and E1 do not include mold flash or protrusions. Mold flash or protrusions shall not exceed 0.15 mm per side.
- Dimensioning and tolerancing per ASME Y14.5M.

BSC: Basic Dimension. Theoretically exact value shown without tolerances.

REF: Reference Dimension, usually without tolerance, for information purposes only.

Microchip Technology Drawing C04-057B

MCP4901/4911/4921

8-Lead Plastic Small Outline (SN) – Narrow, 3.90 mm Body [SOIC]

Note: For the most current package drawings, please see the Microchip Packaging Specification located at <http://www.microchip.com/packaging>



RECOMMENDED LAND PATTERN

Dimension Limits	Units	MILLIMETERS		
		MIN	NOM	MAX
Contact Pitch	E	1.27 BSC		
Contact Pad Spacing	C		5.40	
Contact Pad Width (X8)	X1			0.60
Contact Pad Length (X8)	Y1			1.55

Notes:

1. Dimensioning and tolerancing per ASME Y14.5M

BSC: Basic Dimension. Theoretically exact value shown without tolerances.

Microchip Technology Drawing No. C04-2057A

MCP4901/4911/4921

8-Lead Plastic Dual In-Line (P) – 300 mil Body [PDIP]

Note: For the most current package drawings, please see the Microchip Packaging Specification located at <http://www.microchip.com/packaging>

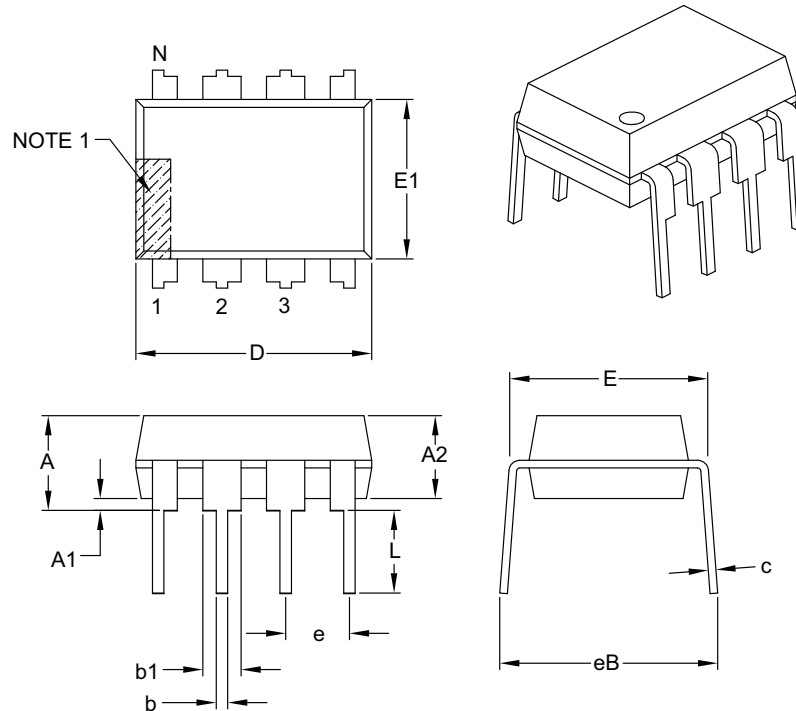

Dimension Limits	Units	INCHES		
		MIN	NOM	MAX
Number of Pins	N	8		
Pitch	e	.100 BSC		
Top to Seating Plane	A	–	–	.210
Molded Package Thickness	A2	.115	.130	.195
Base to Seating Plane	A1	.015	–	–
Shoulder to Shoulder Width	E	.290	.310	.325
Molded Package Width	E1	.240	.250	.280
Overall Length	D	.348	.365	.400
Tip to Seating Plane	L	.115	.130	.150
Lead Thickness	c	.008	.010	.015
Upper Lead Width	b1	.040	.060	.070
Lower Lead Width	b	.014	.018	.022
Overall Row Spacing §	eB	–	–	.430

Notes:

- Pin 1 visual index feature may vary, but must be located with the hatched area.
- § Significant Characteristic.
- Dimensions D and E1 do not include mold flash or protrusions. Mold flash or protrusions shall not exceed .010" per side.
- Dimensioning and tolerancing per ASME Y14.5M.

BSC: Basic Dimension. Theoretically exact value shown without tolerances.

Microchip Technology Drawing C04-018B

APPENDIX A: REVISION HISTORY

Revision A (April 2010)

- Original Release of this Document.

MCP4901/4911/4921

NOTES:

MCP4901/4911/4921

PRODUCT IDENTIFICATION SYSTEM

To order or obtain information, e.g., on pricing or delivery, refer to the factory or the listed sales office.

<u>PART NO.</u>	<u>X</u>	<u>/XX</u>	
Device	Temperature Range	Package	
Device	MCP4901:	8-Bit Voltage Output DAC	
	MCP4901T:	8-Bit Voltage Output DAC (Tape and Reel)	
	MCP4911:	10-Bit Voltage Output DAC	
	MCP4911T:	10-Bit Voltage Output DAC (Tape and Reel)	
	MCP4921:	12-Bit Voltage Output DAC	
	MCP4921T:	12-Bit Voltage Output DAC (Tape and Reel)	
Temperature Range	E	= -40°C to +125°C	(Extended)
Package	MC	= 8-Lead Plastic Dual Flat, No Lead Package - 2x3x0.9 mm Body (DFN)	
	MS	= 8-Lead Plastic Micro Small Outline (MSOP)	
	SN	= 8-Lead Plastic Small Outline - Narrow, 150 mil (SOIC)	
	P	= 8-Lead Plastic Dual In-Line (PDIP)	

Examples:	
a)	MCP4901-E/P: Extended temperature, PDIP package.
b)	MCP4901-E/SN: Extended temperature, SOIC package.
c)	MCP4901T-E/SN: Extended temperature, SOIC package Tape and Reel.
d)	MCP4901-E/MS: Extended temperature, MSOP package.
e)	MCP4901T-E/MS: Extended temperature, MSOP package Tape and Reel.
f)	MCP4901-E/MC: Extended temperature, DFN package.
g)	MCP4901T-E/MC: Extended temperature, DFN package Tape and Reel.
h)	MCP4911-E/P: Extended temperature, PDIP package.
i)	MCP4911-E/SN: Extended temperature, SOIC package.
j)	MCP4911T-E/SN: Extended temperature, SOIC package Tape and Reel.
k)	MCP4911-E/MS: Extended temperature, MSOP package.
l)	MCP4911T-E/MS: Extended temperature, MSOP package Tape and Reel.
m)	MCP4911-E/MC: Extended temperature, DFN package.
n)	MCP4911T-E/MC: Extended temperature, DFN package Tape and Reel.
o)	MCP4921-E/P: Extended temperature, PDIP package.
p)	MCP4921-E/SL: Extended temperature, SOIC package.
q)	MCP4921T-E/SL: Extended temperature, SOIC package Tape and Reel.
r)	MCP4921-E/MS: Extended temperature, MSOP package.
s)	MCP4921T-E/MS: Extended temperature, MSOP package Tape and Reel.
t)	MCP4921-E/MC: Extended temperature, DFN package.
u)	MCP4921T-E/MC: Extended temperature, DFN package Tape and Reel.

MCP4901/4911/4921

NOTES:

Note the following details of the code protection feature on Microchip devices:

- Microchip products meet the specification contained in their particular Microchip Data Sheet.
- Microchip believes that its family of products is one of the most secure families of its kind on the market today, when used in the intended manner and under normal conditions.
- There are dishonest and possibly illegal methods used to breach the code protection feature. All of these methods, to our knowledge, require using the Microchip products in a manner outside the operating specifications contained in Microchip's Data Sheets. Most likely, the person doing so is engaged in theft of intellectual property.
- Microchip is willing to work with the customer who is concerned about the integrity of their code.
- Neither Microchip nor any other semiconductor manufacturer can guarantee the security of their code. Code protection does not mean that we are guaranteeing the product as “unbreakable.”

Code protection is constantly evolving. We at Microchip are committed to continuously improving the code protection features of our products. Attempts to break Microchip's code protection feature may be a violation of the Digital Millennium Copyright Act. If such acts allow unauthorized access to your software or other copyrighted work, you may have a right to sue for relief under that Act.

Information contained in this publication regarding device applications and the like is provided only for your convenience and may be superseded by updates. It is your responsibility to ensure that your application meets with your specifications. MICROCHIP MAKES NO REPRESENTATIONS OR WARRANTIES OF ANY KIND WHETHER EXPRESS OR IMPLIED, WRITTEN OR ORAL, STATUTORY OR OTHERWISE, RELATED TO THE INFORMATION, INCLUDING BUT NOT LIMITED TO ITS CONDITION, QUALITY, PERFORMANCE, MERCHANTABILITY OR FITNESS FOR PURPOSE. Microchip disclaims all liability arising from this information and its use. Use of Microchip devices in life support and/or safety applications is entirely at the buyer's risk, and the buyer agrees to defend, indemnify and hold harmless Microchip from any and all damages, claims, suits, or expenses resulting from such use. No licenses are conveyed, implicitly or otherwise, under any Microchip intellectual property rights.

Trademarks

The Microchip name and logo, the Microchip logo, dsPIC, KEELOQ, KEELOQ logo, MPLAB, PIC, PICmicro, PICSTART, PIC³² logo, rPIC and UNI/O are registered trademarks of Microchip Technology Incorporated in the U.S.A. and other countries.

FilterLab, Hampshire, HI-TECH C, Linear Active Thermistor, MXDEV, MXLAB, SEEVAL and The Embedded Control Solutions Company are registered trademarks of Microchip Technology Incorporated in the U.S.A.

Analog-for-the-Digital Age, Application Maestro, CodeGuard, dsPICDEM, dsPICDEM.net, dsPICworks, dsSPEAK, ECAN, ECONOMONITOR, FanSense, HI-TIDE, In-Circuit Serial Programming, ICSP, Mindi, MiWi, MPASM, MPLAB Certified logo, MPLIB, MPLINK, mTouch, Octopus, Omniscient Code Generation, PICC, PICC-18, PICDEM, PICDEM.net, PICkit, PICTail, REAL ICE, rLAB, Select Mode, Total Endurance, TSHARC, UniWinDriver, WiperLock and ZENA are trademarks of Microchip Technology Incorporated in the U.S.A. and other countries.

SQTP is a service mark of Microchip Technology Incorporated in the U.S.A.

All other trademarks mentioned herein are property of their respective companies.

© 2010, Microchip Technology Incorporated, Printed in the U.S.A., All Rights Reserved.

 Printed on recycled paper.

ISBN:

Microchip received ISO/TS-16949:2002 certification for its worldwide headquarters, design and wafer fabrication facilities in Chandler and Tempe, Arizona; Gresham, Oregon and design centers in California and India. The Company's quality system processes and procedures are for its PIC® MCUs and dsPIC® DSCs, KEELOQ® code hopping devices, Serial EEPROMs, microperipherals, nonvolatile memory and analog products. In addition, Microchip's quality system for the design and manufacture of development systems is ISO 9001:2000 certified.

**QUALITY MANAGEMENT SYSTEM
CERTIFIED BY DNV
== ISO/TS 16949:2002 ==**



WORLDWIDE SALES AND SERVICE

AMERICAS

Corporate Office
2355 West Chandler Blvd.
Chandler, AZ 85224-6199
Tel: 480-792-7200
Fax: 480-792-7277
Technical Support:
<http://support.microchip.com>
Web Address:
www.microchip.com

Atlanta
Duluth, GA
Tel: 678-957-9614
Fax: 678-957-1455

Boston
Westborough, MA
Tel: 774-760-0087
Fax: 774-760-0088

Chicago
Itasca, IL
Tel: 630-285-0071
Fax: 630-285-0075

Cleveland
Independence, OH
Tel: 216-447-0464
Fax: 216-447-0643

Dallas
Addison, TX
Tel: 972-818-7423
Fax: 972-818-2924

Detroit
Farmington Hills, MI
Tel: 248-538-2250
Fax: 248-538-2260

Kokomo
Kokomo, IN
Tel: 765-864-8360
Fax: 765-864-8387

Los Angeles
Mission Viejo, CA
Tel: 949-462-9523
Fax: 949-462-9608

Santa Clara
Santa Clara, CA
Tel: 408-961-6444
Fax: 408-961-6445

Toronto
Mississauga, Ontario,
Canada
Tel: 905-673-0699
Fax: 905-673-6509

ASIA/PACIFIC

Asia Pacific Office
Suites 3707-14, 37th Floor
Tower 6, The Gateway
Harbour City, Kowloon
Hong Kong
Tel: 852-2401-1200
Fax: 852-2401-3431

Australia - Sydney
Tel: 61-2-9868-6733
Fax: 61-2-9868-6755

China - Beijing
Tel: 86-10-8528-2100
Fax: 86-10-8528-2104

China - Chengdu
Tel: 86-28-8665-5511
Fax: 86-28-8665-7889

China - Chongqing
Tel: 86-23-8980-9588
Fax: 86-23-8980-9500

China - Hong Kong SAR
Tel: 852-2401-1200
Fax: 852-2401-3431

China - Nanjing
Tel: 86-25-8473-2460
Fax: 86-25-8473-2470

China - Qingdao
Tel: 86-532-8502-7355
Fax: 86-532-8502-7205

China - Shanghai
Tel: 86-21-5407-5533
Fax: 86-21-5407-5066

China - Shenyang
Tel: 86-24-2334-2829
Fax: 86-24-2334-2393

China - Shenzhen
Tel: 86-755-8203-2660
Fax: 86-755-8203-1760

China - Wuhan
Tel: 86-27-5980-5300
Fax: 86-27-5980-5118

China - Xian
Tel: 86-29-8833-7252
Fax: 86-29-8833-7256

China - Xiamen
Tel: 86-592-2388138
Fax: 86-592-2388130

China - Zhuhai
Tel: 86-756-3210040
Fax: 86-756-3210049

ASIA/PACIFIC

India - Bangalore
Tel: 91-80-3090-4444
Fax: 91-80-3090-4123

India - New Delhi
Tel: 91-11-4160-8631
Fax: 91-11-4160-8632

India - Pune
Tel: 91-20-2566-1512
Fax: 91-20-2566-1513

Japan - Yokohama
Tel: 81-45-471- 6166
Fax: 81-45-471-6122

Korea - Daegu
Tel: 82-53-744-4301
Fax: 82-53-744-4302

Korea - Seoul
Tel: 82-2-554-7200
Fax: 82-2-558-5932 or
82-2-558-5934

Malaysia - Kuala Lumpur
Tel: 60-3-6201-9857
Fax: 60-3-6201-9859

Malaysia - Penang
Tel: 60-4-227-8870
Fax: 60-4-227-4068

Philippines - Manila
Tel: 63-2-634-9065
Fax: 63-2-634-9069

Singapore
Tel: 65-6334-8870
Fax: 65-6334-8850

Taiwan - Hsin Chu
Tel: 886-3-6578-300
Fax: 886-3-6578-370

Taiwan - Kaohsiung
Tel: 886-7-536-4818
Fax: 886-7-536-4803

Taiwan - Taipei
Tel: 886-2-2500-6610
Fax: 886-2-2508-0102

Thailand - Bangkok
Tel: 66-2-694-1351
Fax: 66-2-694-1350

EUROPE

Austria - Wels
Tel: 43-7242-2244-39
Fax: 43-7242-2244-393

Denmark - Copenhagen
Tel: 45-4450-2828
Fax: 45-4485-2829

France - Paris
Tel: 33-1-69-53-63-20
Fax: 33-1-69-30-90-79

Germany - Munich
Tel: 49-89-627-144-0
Fax: 49-89-627-144-44

Italy - Milan
Tel: 39-0331-742611
Fax: 39-0331-466781

Netherlands - Drunen
Tel: 31-416-690399
Fax: 31-416-690340

Spain - Madrid
Tel: 34-91-708-08-90
Fax: 34-91-708-08-91

UK - Wokingham
Tel: 44-118-921-5869
Fax: 44-118-921-5820

01/05/10

Компания «Life Electronics» занимается поставками электронных компонентов импортного и отечественного производства от производителей и со складов крупных дистрибьюторов Европы, Америки и Азии.

С конца 2013 года компания активно расширяет линейку поставок компонентов по направлению коаксиальный кабель, кварцевые генераторы и конденсаторы (керамические, пленочные, электролитические), за счёт заключения дистрибьюторских договоров

Мы предлагаем:

- Конкурентоспособные цены и скидки постоянным клиентам.
- Специальные условия для постоянных клиентов.
- Подбор аналогов.
- Поставку компонентов в любых объемах, удовлетворяющих вашим потребностям.
- Приемлемые сроки поставки, возможна ускоренная поставка.
- Доставку товара в любую точку России и стран СНГ.
- Комплексную поставку.
- Работу по проектам и поставку образцов.
- Формирование склада под заказчика.
- Сертификаты соответствия на поставляемую продукцию (по желанию клиента).
- Тестирование поставляемой продукции.
- Поставку компонентов, требующих военную и космическую приемку.
- Входной контроль качества.
- Наличие сертификата ISO.

В составе нашей компании организован Конструкторский отдел, призванный помогать разработчикам, и инженерам.

Конструкторский отдел помогает осуществить:

- Регистрацию проекта у производителя компонентов.
- Техническую поддержку проекта.
- Защиту от снятия компонента с производства.
- Оценку стоимости проекта по компонентам.
- Изготовление тестовой платы монтаж и пусконаладочные работы.



Тел: +7 (812) 336 43 04 (многоканальный)
Email: org@lifeelectronics.ru