

LOC	DIST	REVISIONS			
		REV	DATE	BY	APPV
GP	00	C1	REV PER ECR-11-022334	03NOV2011	CZ SZ
		C3	REVISED 1-8	16JAN2014	CZ SZ
		C5	ADDING NOTE FOR 1-8	10SEP2015	CZ SZ
		C6	REVISED 1-0 BY CUSTOMER	05MAY2016	CZ SZ

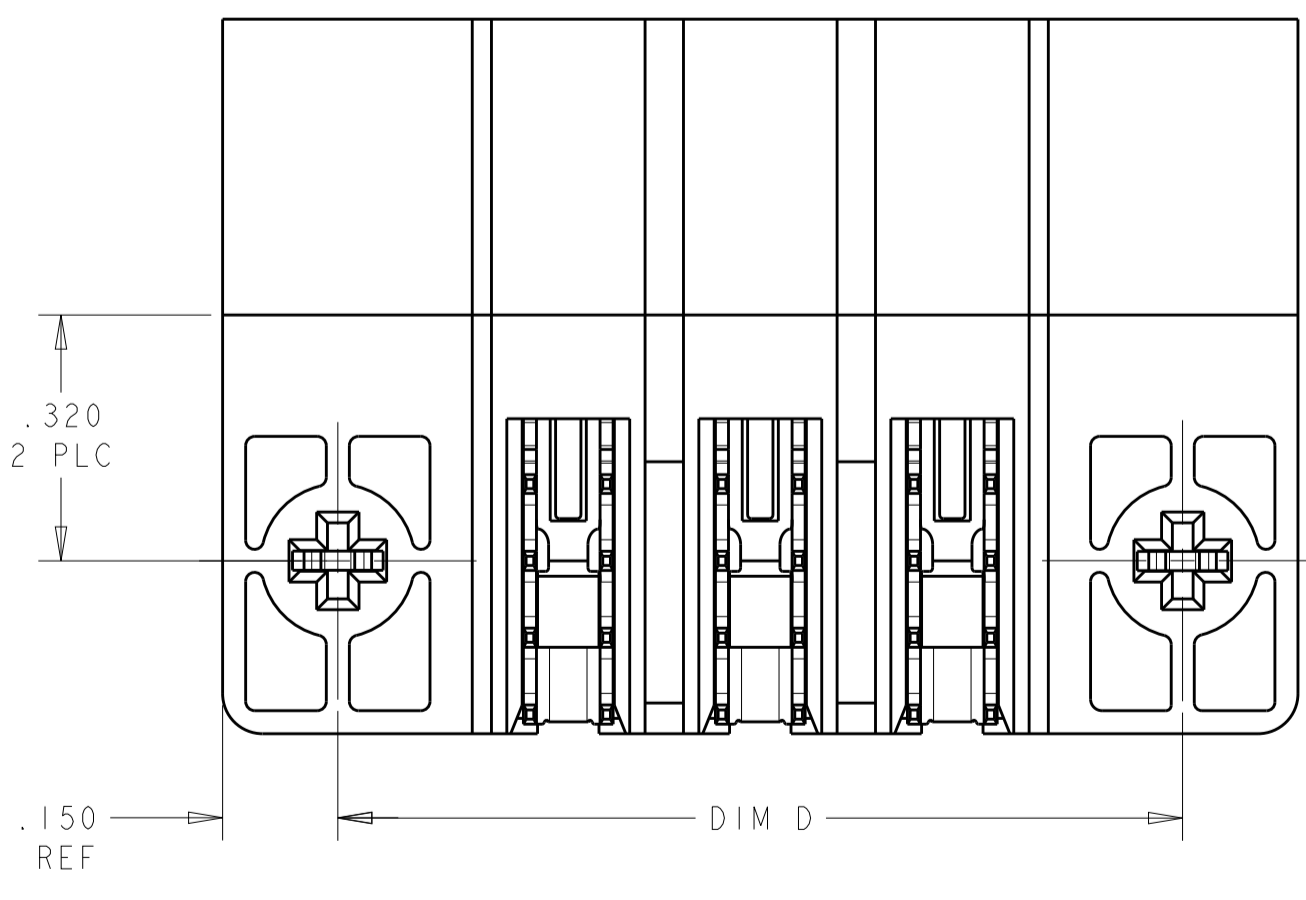
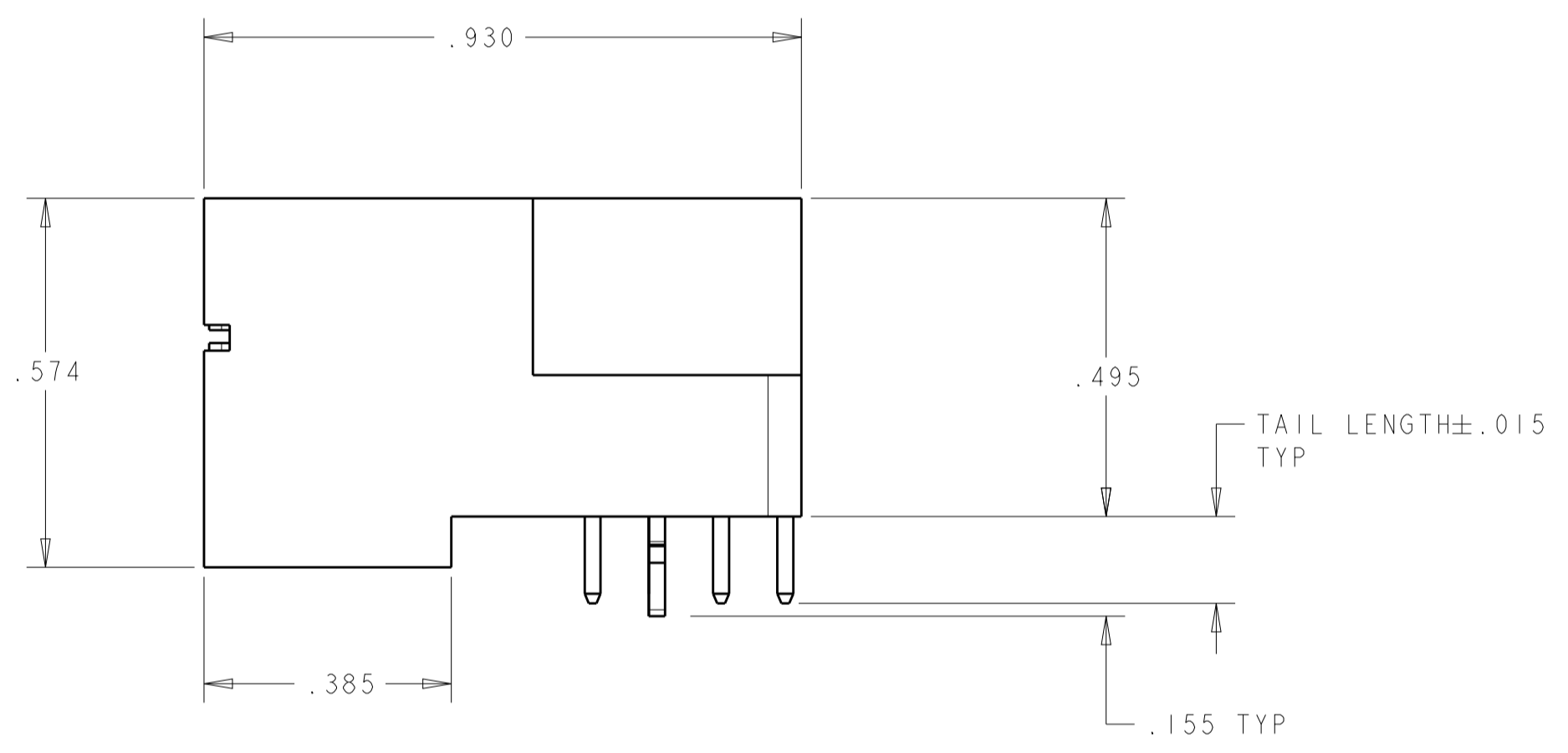
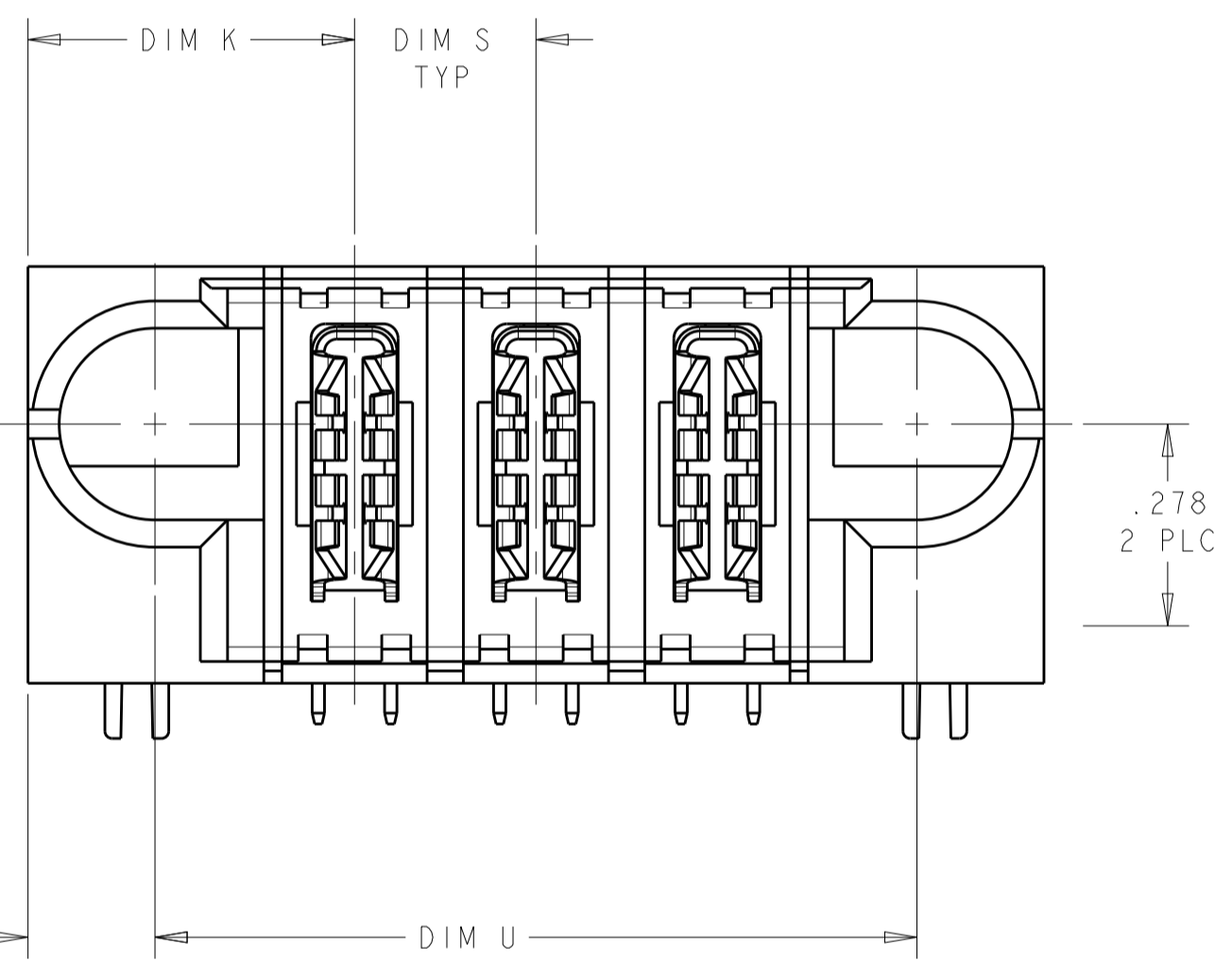
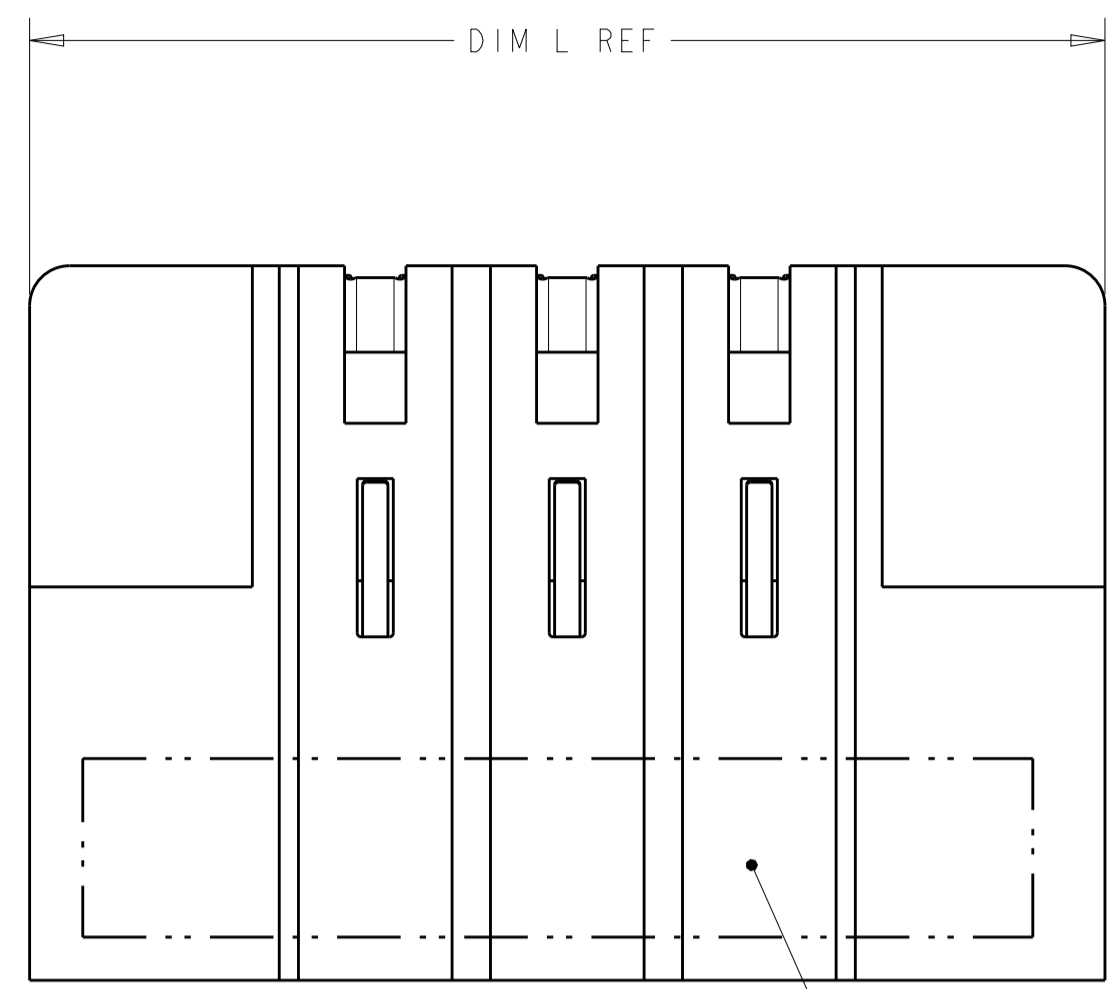

- 1 "AMP", PART NUMBER, AND DATE CODE TO BE MARKED IN AREA SHOWN.
- 2 MATERIAL: HOUSING - GLASS FILLED HIGH TEMP THERMO PLASTIC, UL94 V-0
POWER CONTACT - HIGH CONDUCTIVITY COPPER ALLOY
- 3 CONTACT PLATING: NOBLE METAL PLATING ON CONTACT FUNCTIONAL AREA OF POWER AND SIGNAL CONTACTS
- 4 MECHANICAL CONNECTOR KEEP OUT ZONE.
- 5 DATUM AND BASIC DIMENSIONS ESTABLISHED BY CUSTOMER.
- 6 PCB- ALL HOLE DIAMETERS ARE FINISHED HOLE SIZES.
- 7 PCB - .0453±.0010 DRILLED HOLES WITH .0003 MIN Sn OVER .001 TO .003 Cu PLATING TO ACHIEVE A .040±.003 DIA HOLE.
- 8 VARIABLE DIMENSIONS SHOWN ON VIEW (SHEET 3)
- 9 FOR DETAIL DIMENSION PLEASE REFER TO TABLE

3.750	.200	3.800	.450	4.100	17P	1-6450123-8
1.150	.300	1.200	.450	1.500	3ACP	1-6450123-6
1.725	.375	1.775	.475	2.075	4P	1-6450123-5
2.700	.300	2.750	.475	3.050	8ACP	1-6450123-4
1.300	.200	1.350	.425	1.650	5HDP	1-6450123-2
5.550	.200	5.600	.450	5.900	26P	1-6450123-1
1.750	.200	1.800	.450	2.100	7HDP	1-6450123-0
2.300	.250	2.350	.450	2.650	8P	6450123-8
1.700	8	1.750	.425	2.050	6P	6450123-7
1.550	.250	1.600	.450	1.900	5P	6450123-6
2.050	.250	2.100	.450	2.400	7P	6450123-5
.800	.250	.850	.450	1.150	2P	6450123-4
1.200	.300	1.250	.475	1.550	3ACP	6450123-3
1.300	.250	1.350	.450	1.650	4P	6450123-2
1.050	.250	1.100	.450	1.400	3P	6450123-1
DIM U	DIM S	DIM D	DIM K	DIM L	DESCRIPTION	PART NUMBER

THIS DRAWING IS A CONTROLLED DOCUMENT. DWN: R. GRZYBOWSKI TOFEB05
 CHK: M. PERCHERKE TOFEB05
 APVD: M. PERCHERKE

DIMENSIONS: INCHES
 TOLERANCES UNLESS OTHERWISE SPECIFIED:
 0 PLC ±.01
 1 PLC ±.01
 2 PLC ±.01
 3 PLC ±.005
 4 PLC ±.002
 ANGLES ±.02°
 FINISH

MATERIAL: 2

THIS DRAWING IS A CONTROLLED DOCUMENT. DWN: R. GRZYBOWSKI TOFEB05
 CHK: M. PERCHERKE TOFEB05
 APVD: M. PERCHERKE

PRODUCT SPEC: 108-1973
 APPLICATION SPEC: 114-13038

SIZE: A1
 CAGE CODE: 100779
 DRAWING NO: 6450123

RESTRICTED TO: CUSTOMER DRAWING
 SCALE: 4:1
 SHEET: 1 OF 8
 REV: C6

STE TE Connectivity
 RIGHT ANGLE HEADER ASSEMBLY W/GUIDES
 MULTI-BEAM XL

PART NUMBER	ROWS	POWER		
		P1	P2	P3
6450123-1	D C B A	PM	PM	PM
3P		HD		HD

PART NUMBER	ROWS	POWER		
		P1	P2	P3
6450123-3	D C B A	PM	PM	PM
3ACP		HD		HD

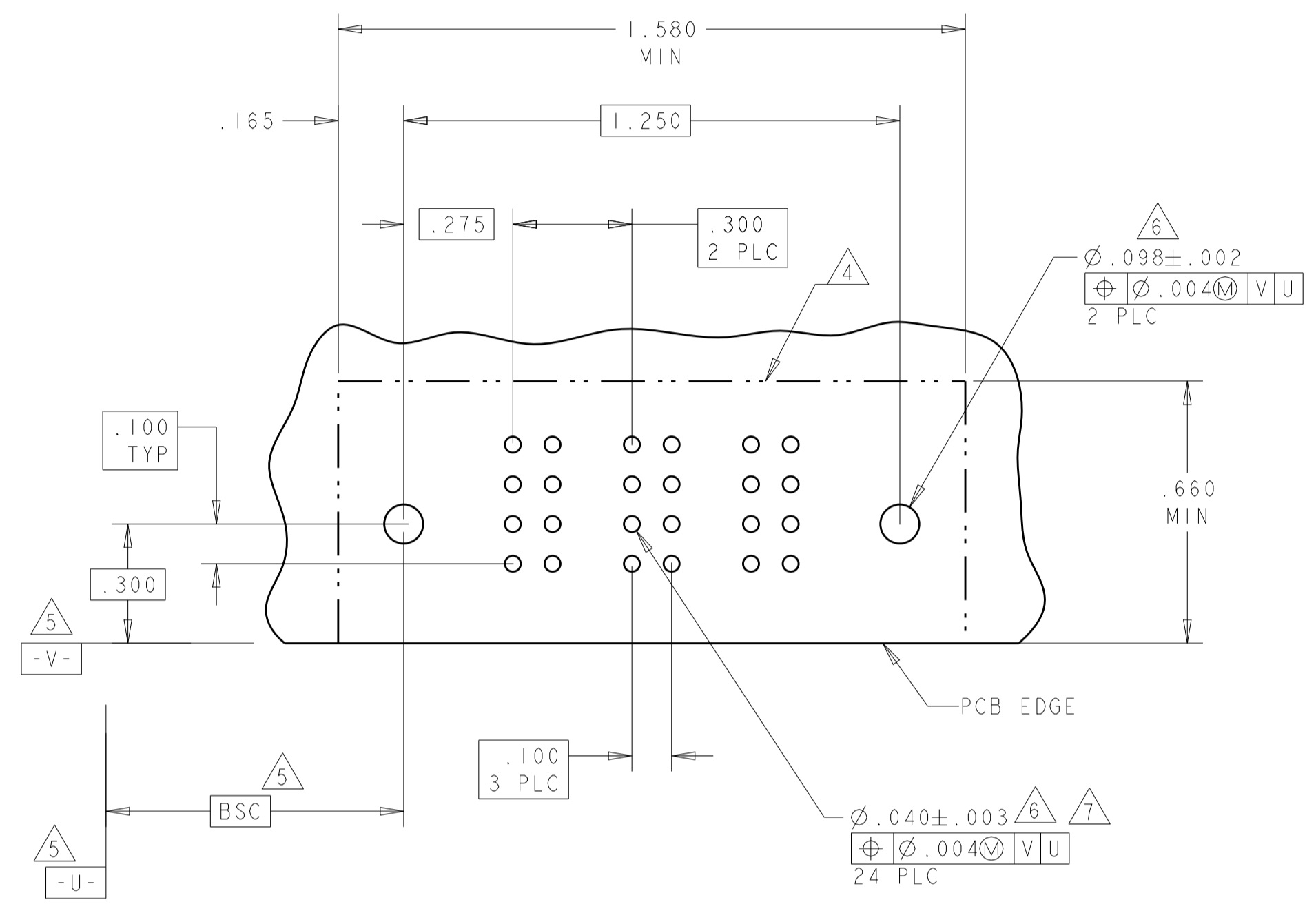
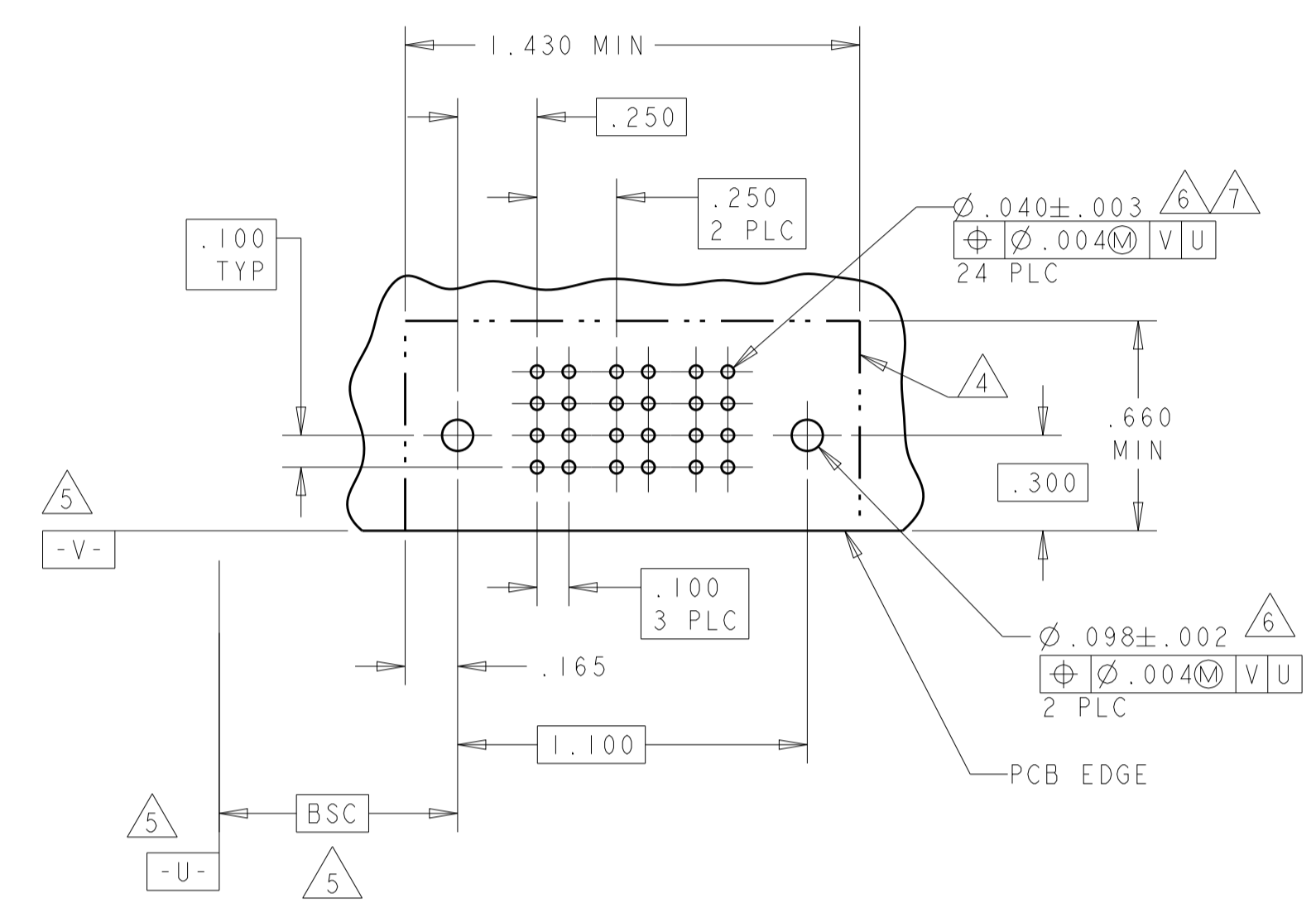

PART NUMBER	ROWS	POWER			
		P1	P2	P3	P4
6450123-2	D C B A	PM	PM	PM	PM
4P		HD			HD

PART NUMBER	ROWS	POWER	
		P1	P2
6450123-4	D C B A	PM	PM
2P		HD	HD

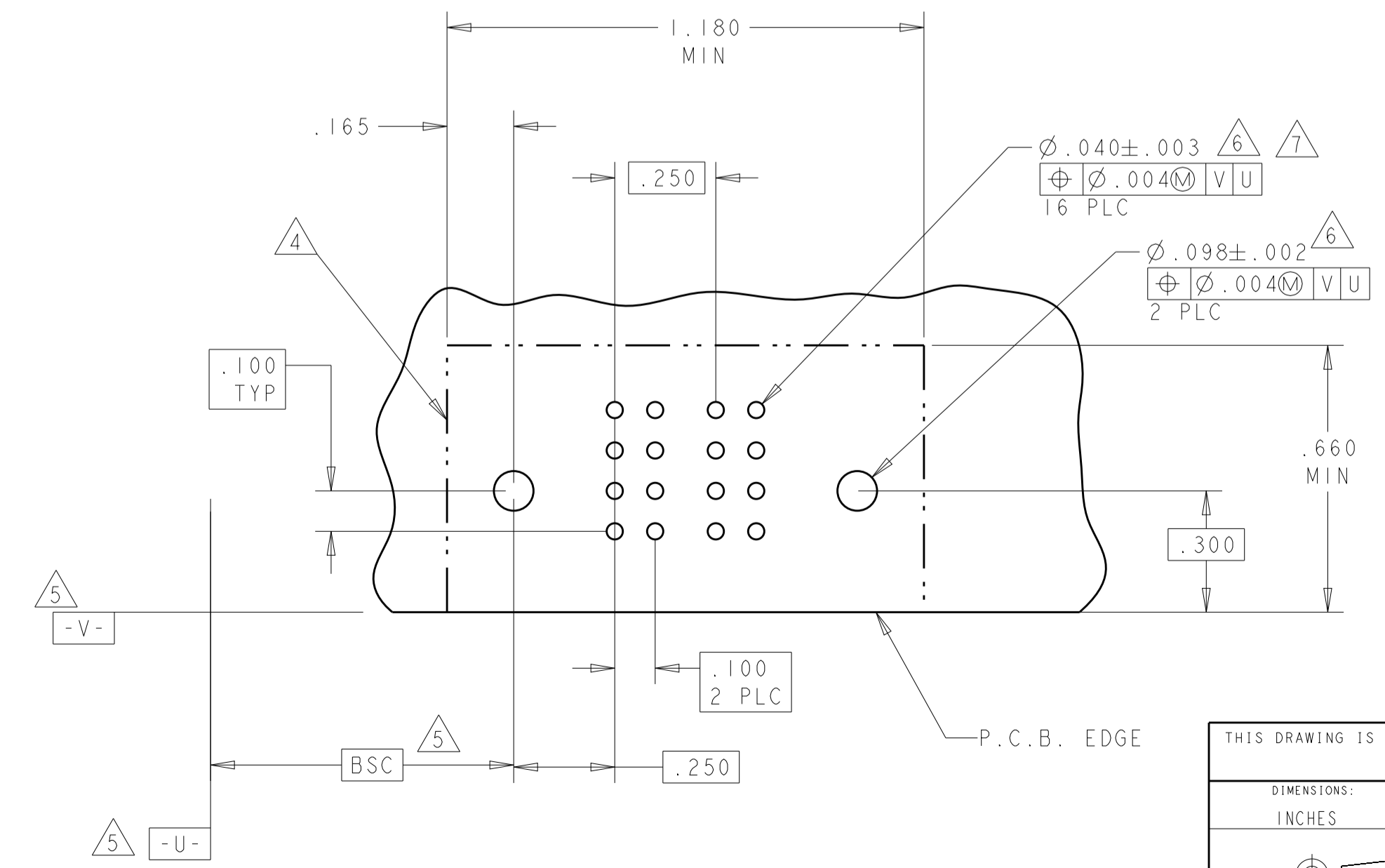
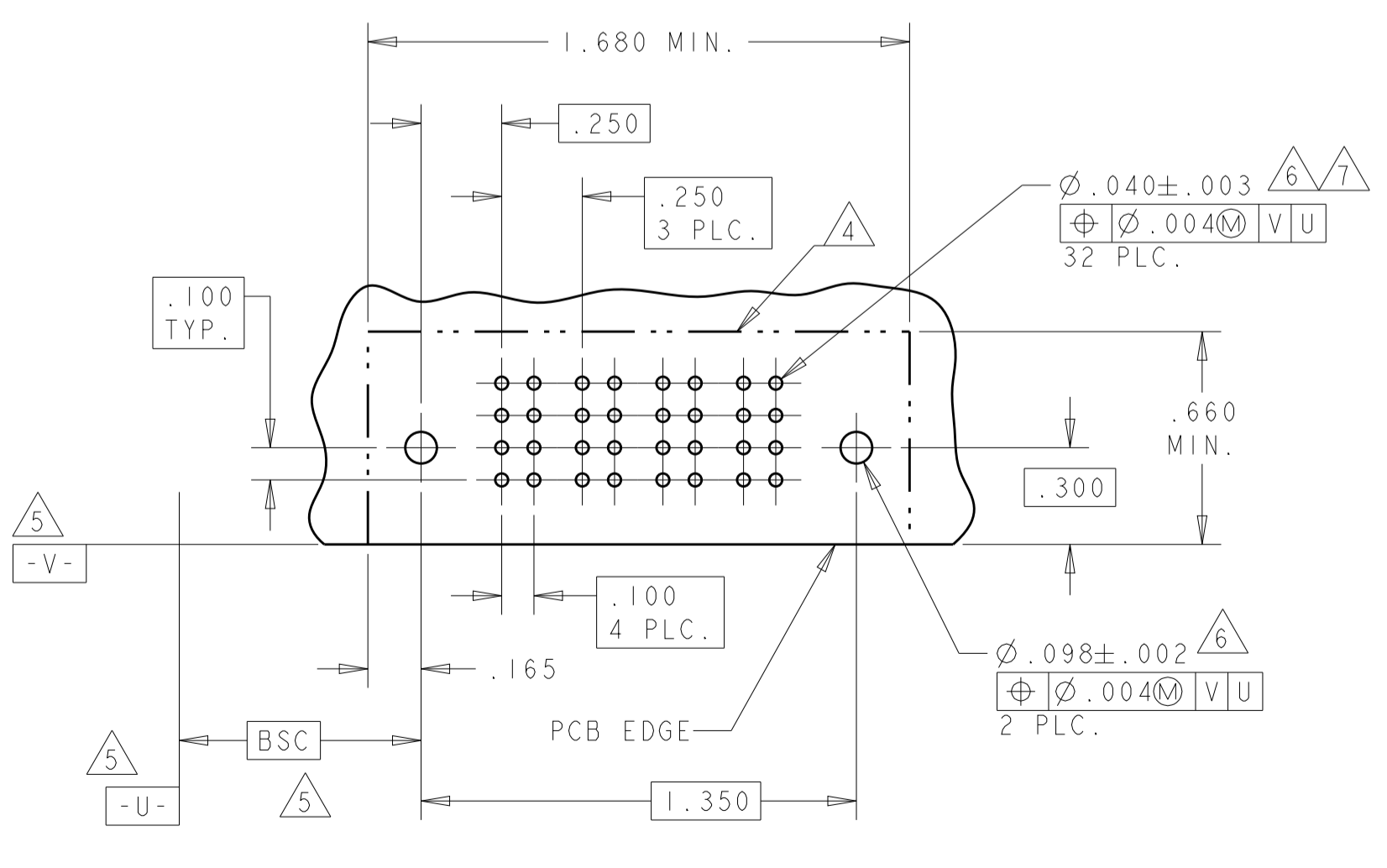

PA	.090
PM	.135
CODE	TAIL LENGTH
POWER CONTACT	

THIS DRAWING IS A CONTROLLED DOCUMENT.

DIMENSIONS:	TOLERANCES UNLESS OTHERWISE SPECIFIED:	OWN: R. GRZYBOWSKI	TOFEB05
INCHES	0 PLC ± .01	CHK: M. PERCHERKE	TOFEB05
	1 PLC ± .01	APVD: M. PERCHERKE	
	2 PLC ± .01	NAME: RIGHT ANGLE HEADER ASSEMBLY W/GUIDES	
	3 PLC ± .005	PRODUCT SPEC: 108-1973	
	4 PLC ± .002	APPLICATION SPEC: 114-13038	
	ANGLES ± .002	SIZE: 114-13038	
MATERIAL:	FINISH:	WEIGHT:	RESTRICTED TO:
			A100779C=6450123
CUSTOMER DRAWING		SCALE: 4:1	SHEET 2 OF 8 REV: C6

PART NUMBER	ROWS	POWER						
		P1	P2	P3	P4	P5	P6	P7
6450123-5	D C B A	PA	PA	PA	PA	PA	PA	PA
7P								

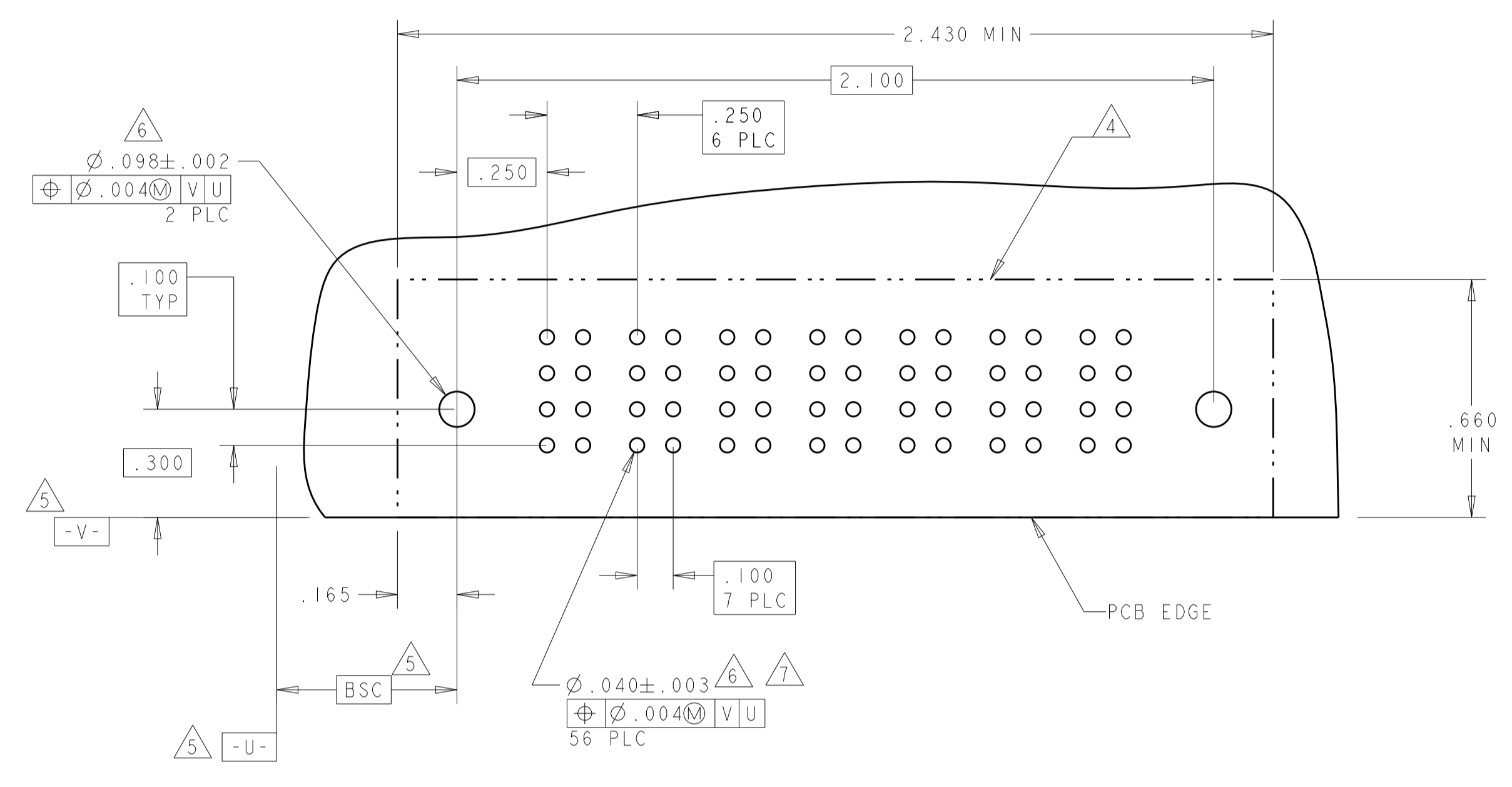

PART NUMBER	ROWS	POWER					
		P1	P2	P3	P4	P5	P6
6450123-7	D C B A	PM	PM	PM	PM	PM	PM
6P							

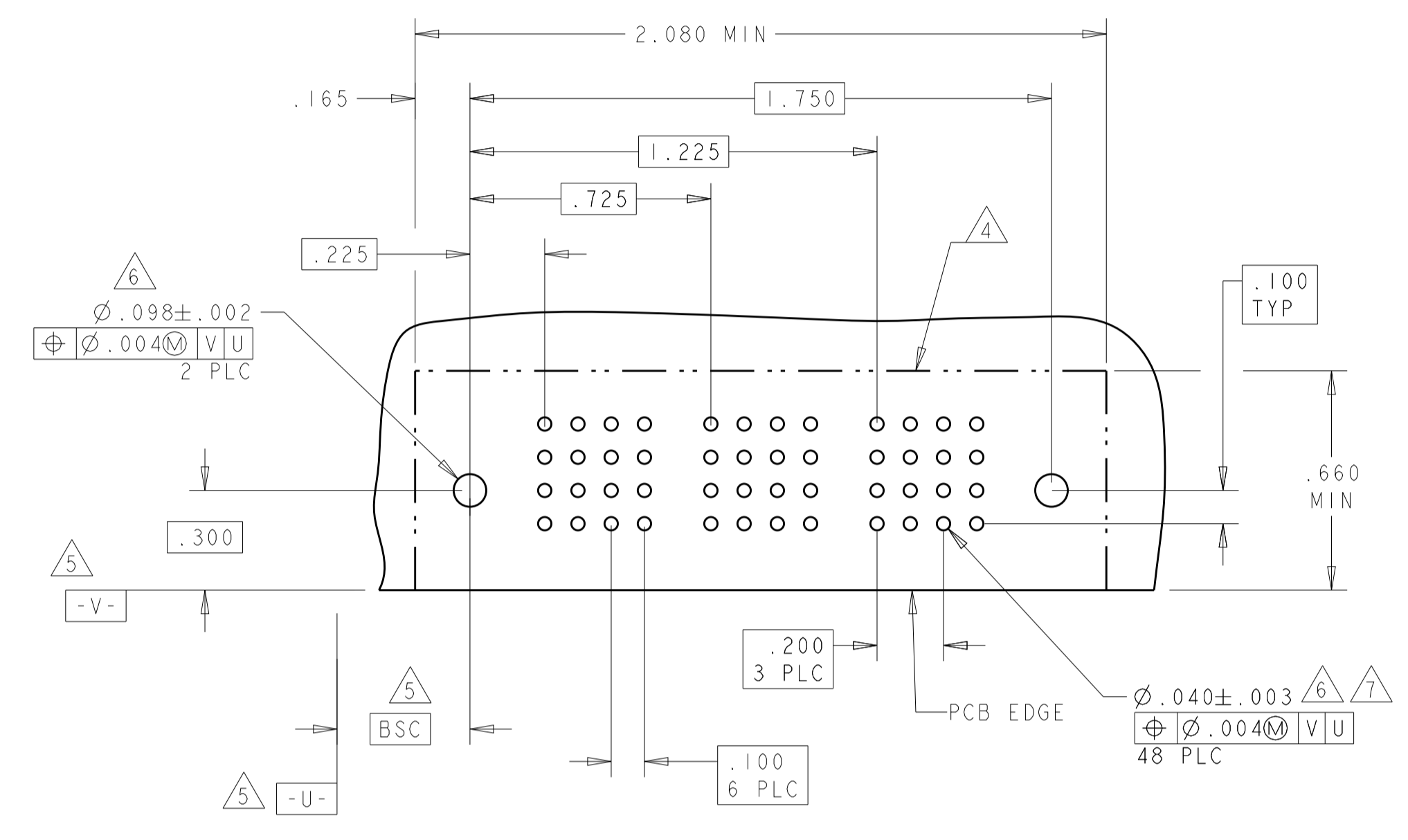

PART NUMBER	ROWS	POWER				
		P1	P2	P3	P4	P5
6450123-6	D C B A	PM	PM	PM	PM	PM
5P						

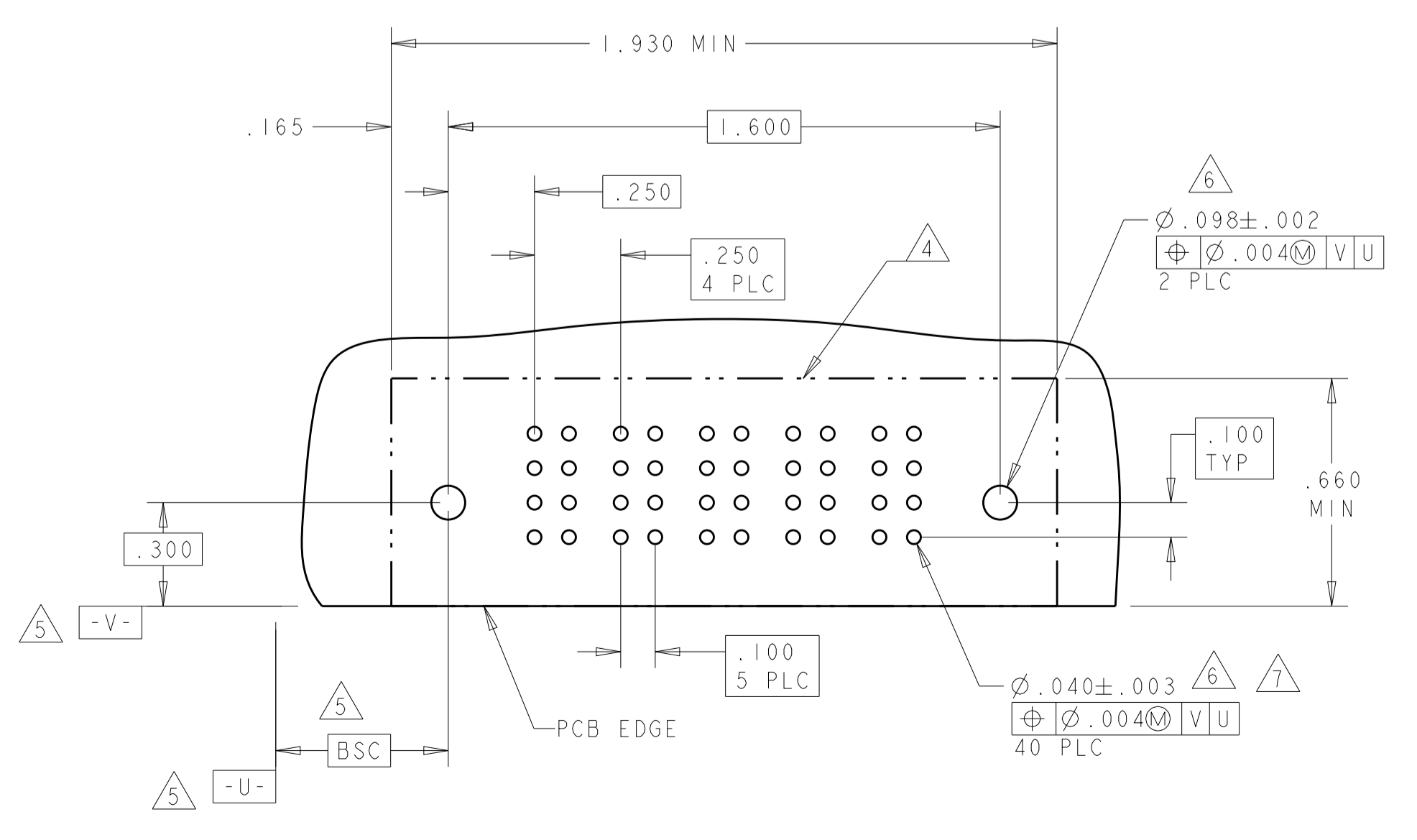

PART NUMBER	ROWS	POWER							
		P1	P2	P3	P4	P5	P6	P7	P8
6450123-8	D C B A	PM	PM	PM	PM	PM	PM	PM	PM
8P									

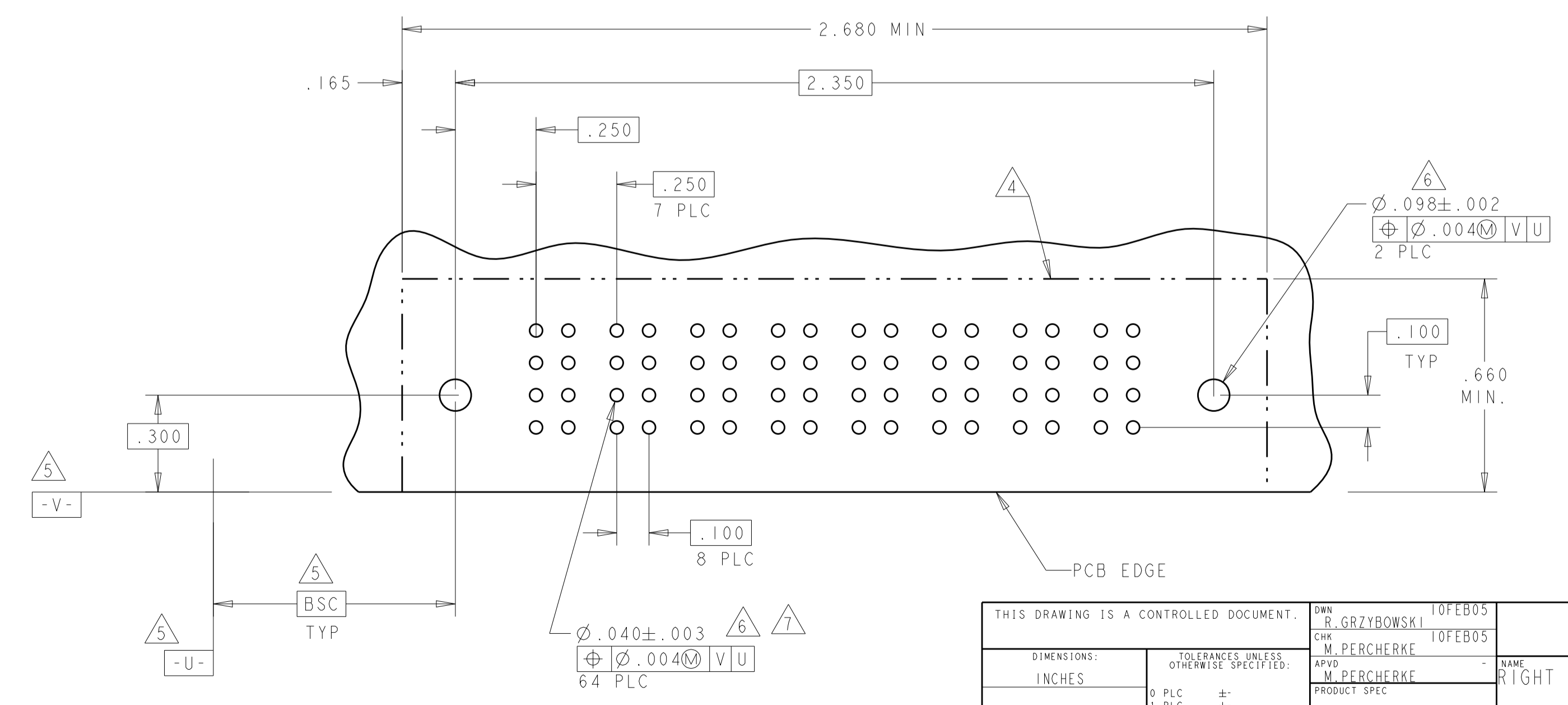

THIS DRAWING IS A CONTROLLED DOCUMENT.		DWN: R. GRZYBOWSKI	10FEB05	STE TE Connectivity
DIMENSIONS: INCHES		CHK: M. PERCHERKE	10FEB05	
TOLERANCES UNLESS OTHERWISE SPECIFIED:		APVD: M. PERCHERKE	NAME: RIGHT ANGLE HEADER ASSEMBLY W/GUIDES MULTI-BEAM XL	
0 PLC ±.01	1 PLC ±.01	PRODUCT SPEC: 108-1973	APPLICATION SPEC: 114-13038	RESTRICTED TO: -
2 PLC ±.005	3 PLC ±.002	SIZE: A1	CAGE CODE: 6450123	SCALE: 4:1
4 PLC ±.002	ANGLES ±.002	WEIGHT: -	SHEET: 3 OF 8	REV: C6
MATERIAL: -		CUSTOMER DRAWING		

LOC	DIST	REVISIONS				
GP	00	P	LTN	DATE	DWN	APVD
		-	SEE SHEET 1			

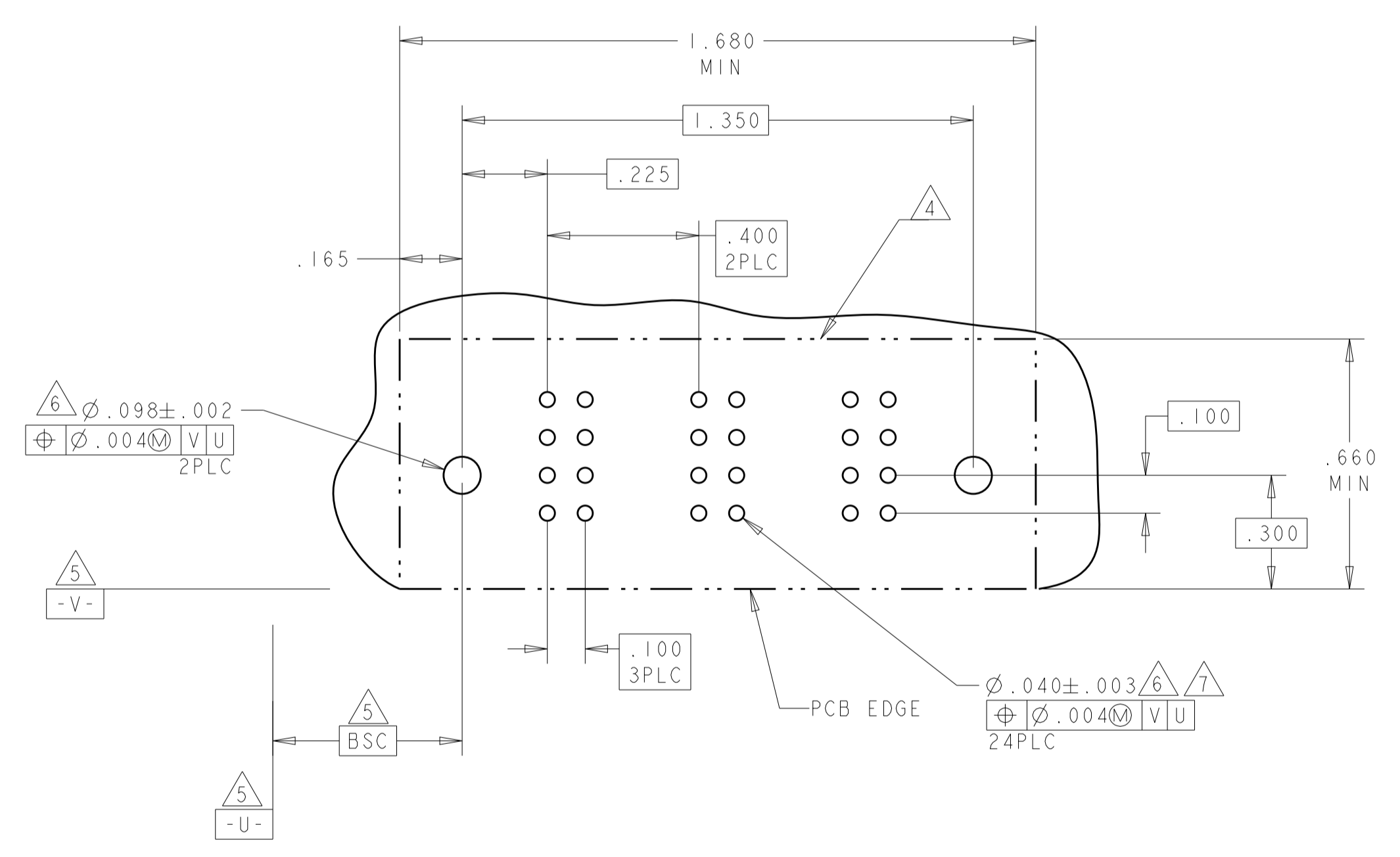
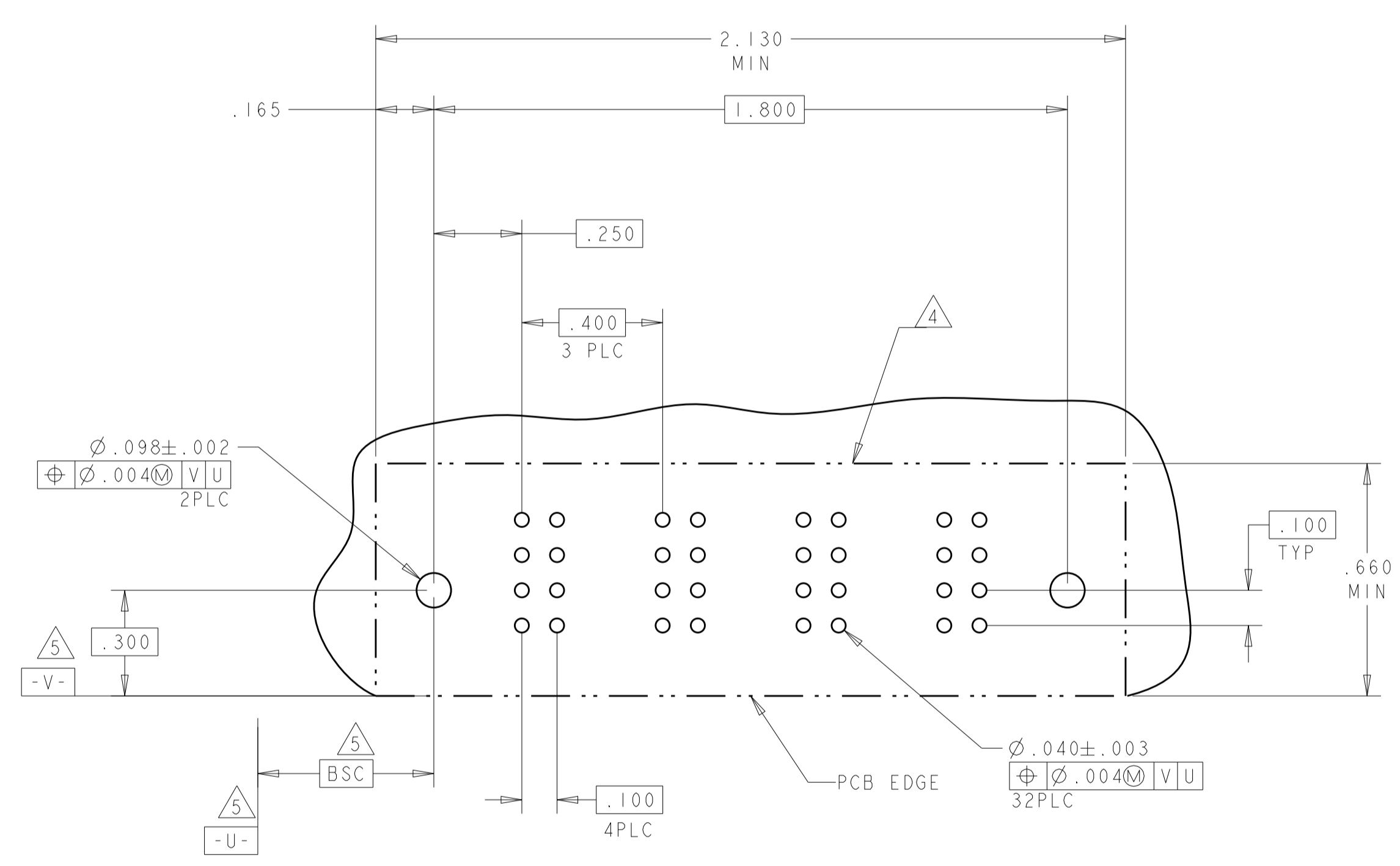
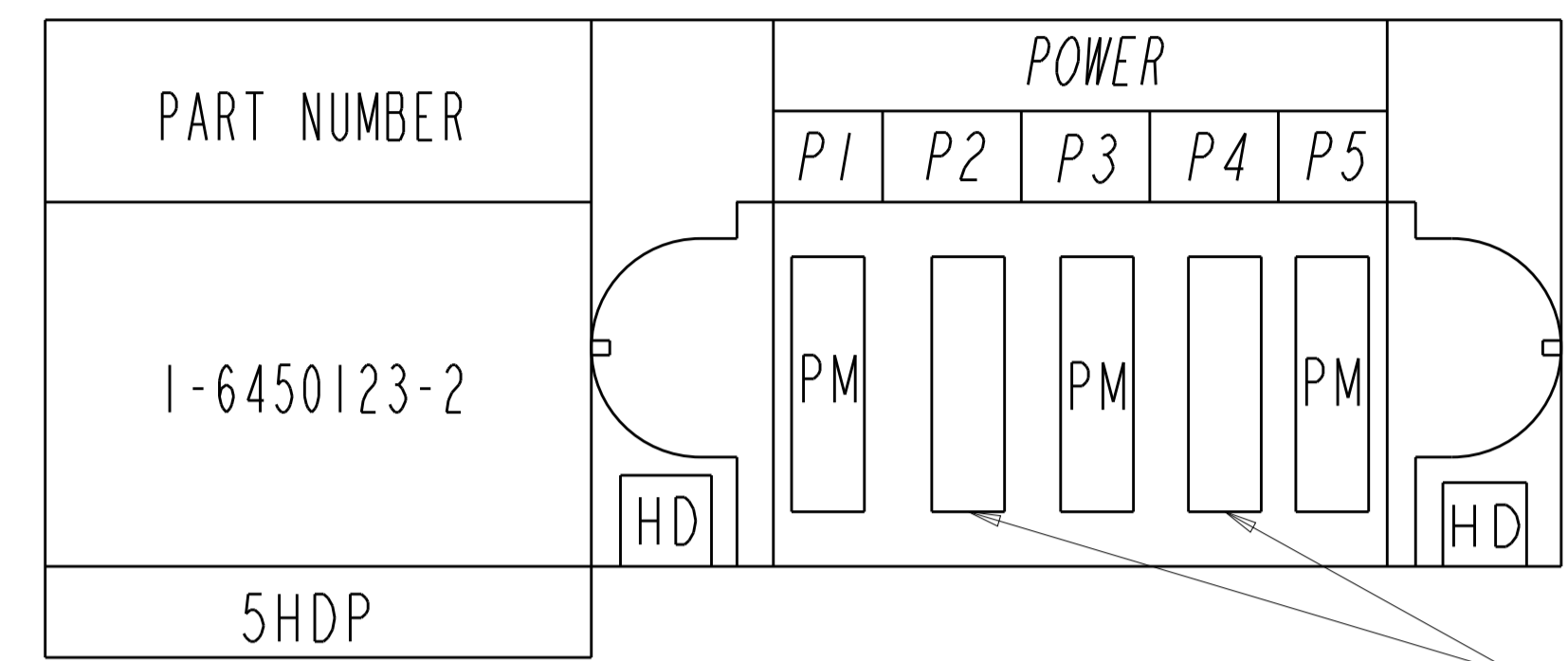
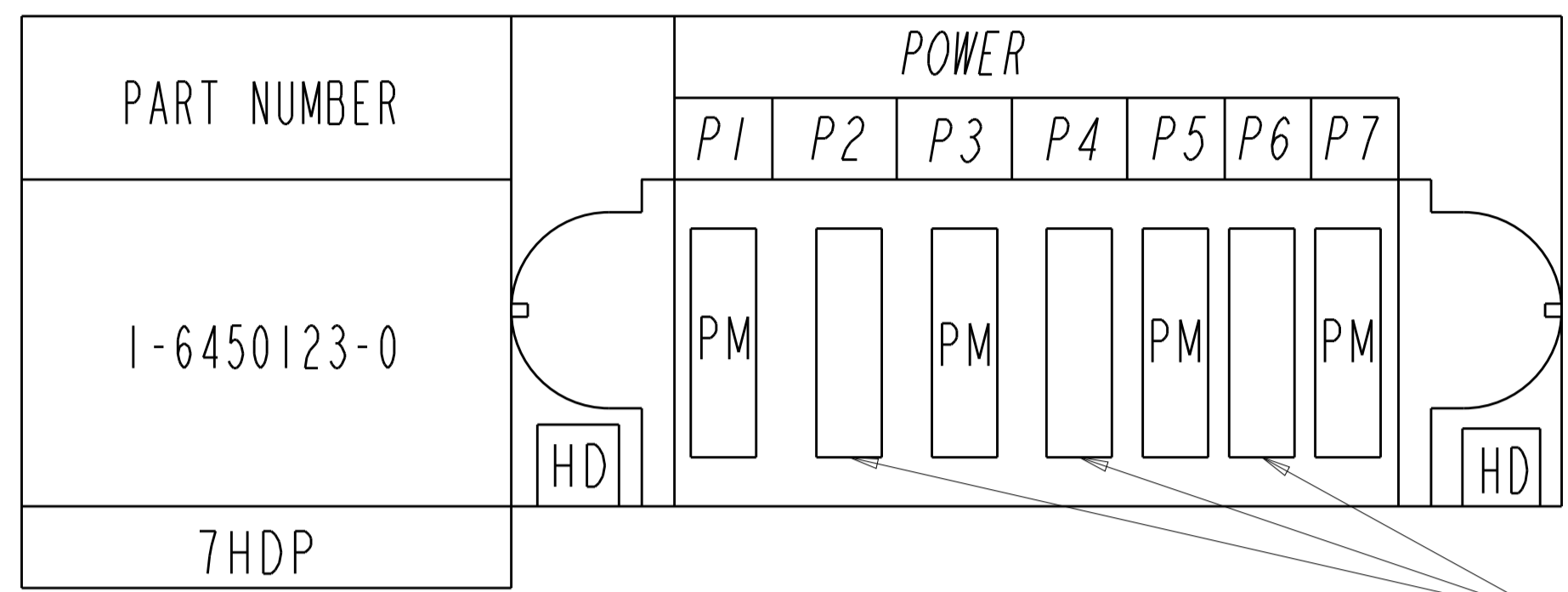

THIS DRAWING IS A CONTROLLED DOCUMENT.		OWN: R. GRZYBOWSKI CHK: M. PERCHERKE APVD: M. PERCHERKE	10FEB05 10FEB05	TE Connectivity NAME: RIGHT ANGLE HEADER ASSEMBLY W/GUIDES MULTI-BEAM XL
DIMENSIONS: INCHES	TOLERANCES UNLESS OTHERWISE SPECIFIED:	PRODUCT SPEC: 108-1973 APPLICATION SPEC: 114-13038	SIZE: 114-13038	
MATERIAL:	FINISH:	WEIGHT:	CAGE CODE: A100779	DRAWING NO: C=6450123
CUSTOMER DRAWING		SCALE: 4:1	SHEET: 4 OF 8	REV: C6

LOC	DIST	REVISIONS			
P	LTN	DESCRIPTION	DATE	DMN	APVD
-	-	SEE SHEET 1	-	-	-

PART NUMBER	ROWS	POWER																									
		P1	P2	P3	P4	P5	P6	P7	P8	P9	P10	P11	P12	P13	P14	P15	P16	P17	P18	P19	P20	P21	P22	P23	P24	P25	P26
1-6450123-1	D C B A	PM	PM	PM	PM	PM	PM	PM	PM	PM	PM	PM	PM	PM	PM	PM	PM	PM	PM	PM	PM	PM	PM	PM	PM	PM	PM
26P																											

NO CONTACTS LOADED

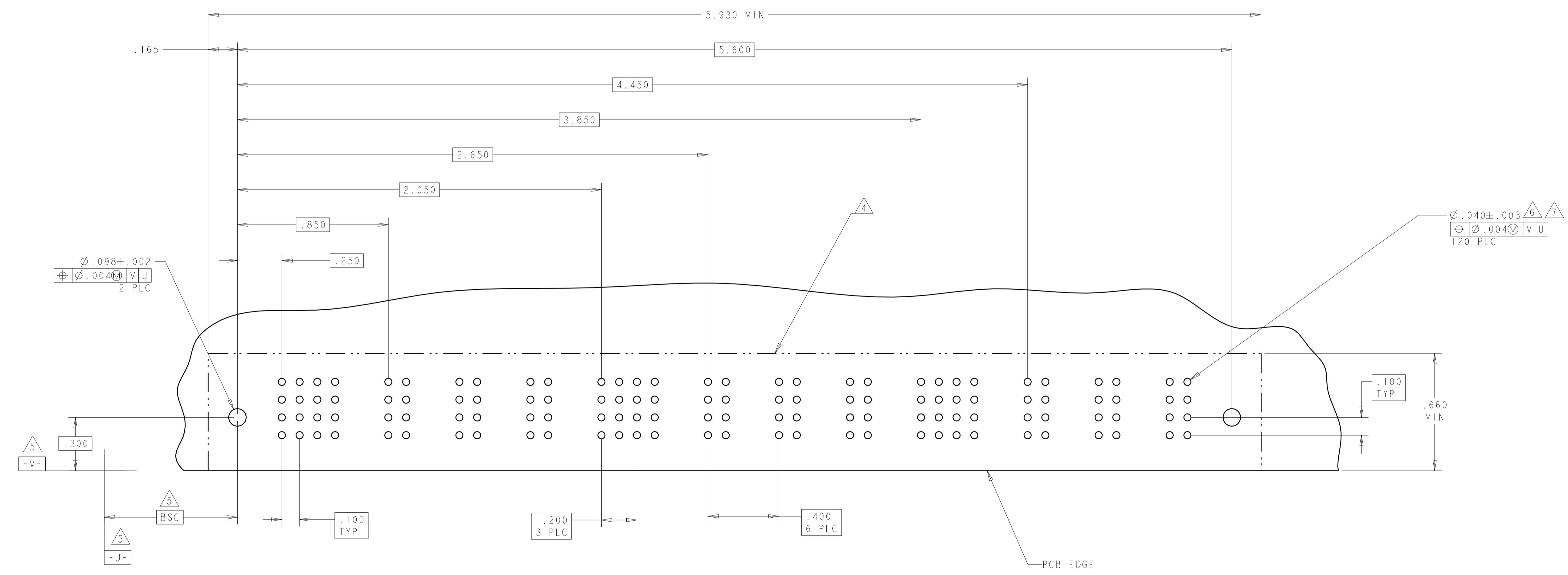

THIS DRAWING IS A CONTROLLED DOCUMENT.		DMN: R. GRZYBOWSKI	TOFEB05	TE Connectivity
DIMENSIONS: INCHES		CHK: M. PERCHERKE	TOFEB05	
TOLERANCES UNLESS OTHERWISE SPECIFIED: 0 PLC ±. 1 PLC ±.01 2 PLC ±.01 3 PLC ±.005 4 PLC ±.0020 ANGLES ±.2° FINISH		APVD: M. PERCHERKE	NAME: RIGHT ANGLE HEADER ASSEMBLY W/GUIDES MULTI-BEAM XL	
MATERIAL: -		PRODUCT SPEC: 108-1973	APPLICATION SPEC: 114-13038	RESTRICTED TO: -
CUSTOMER DRAWING		WEIGHT: -	SCALE: 4:1	SHEET 5 OF 8
		CAGE CODE: A100779	DRAWING NO: C=6450123	REV: C6

LOC	DIST	REVISIONS			
P	LTN	DESCRIPTION	DATE	DMN	APVD
GP	00	SEE SHEET 1	-	-	-

PART NUMBER	ROWS	POWER			
		P1	P2	P3	P4
1-6450123-5	D C B A	PM	PM	PM	PM
4P		HD			HD

PART NUMBER	ROWS	POWER		
		P1	P2	P3
1-6450123-6	D C B A	PM	PM	PM
3ACP		HD		HD

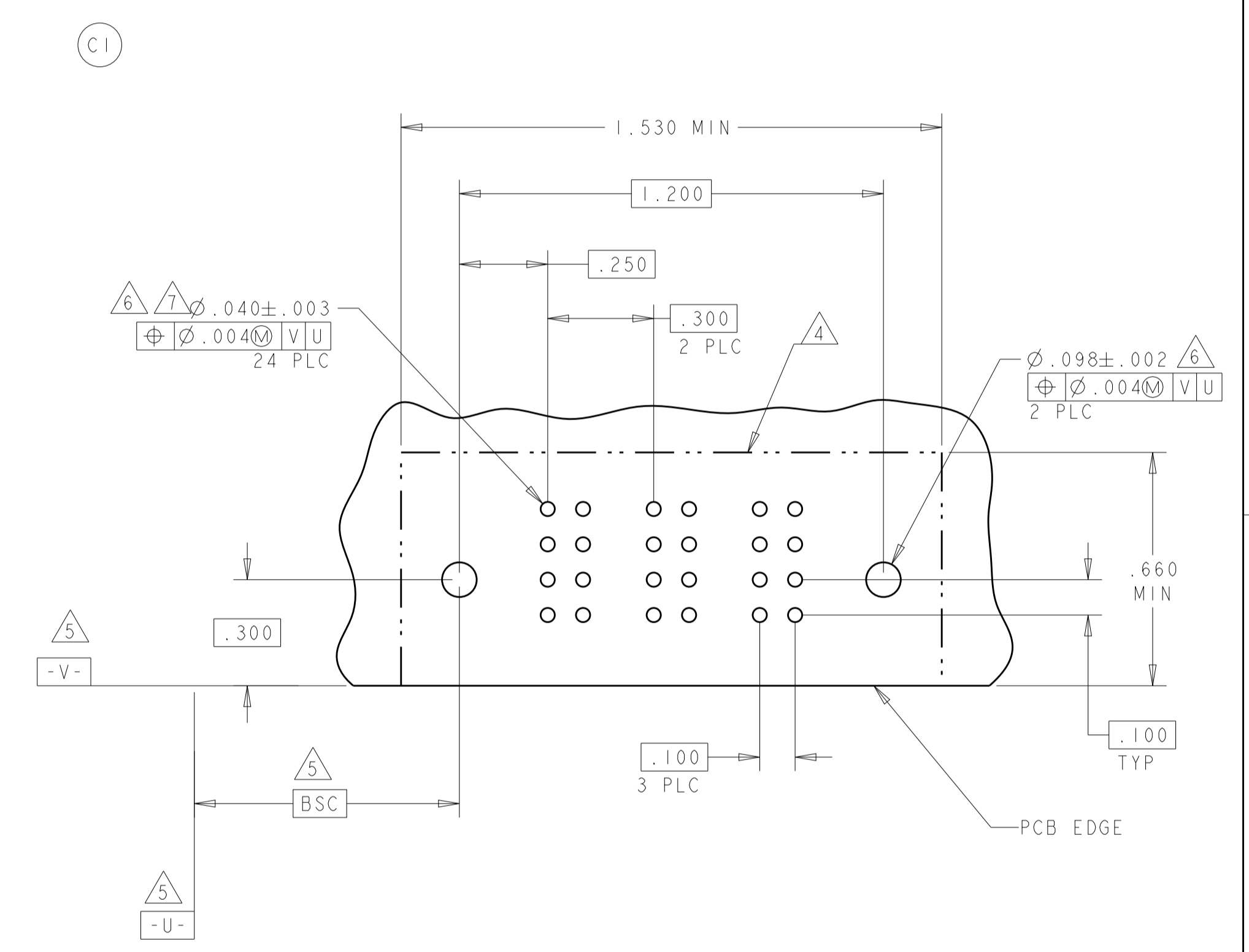
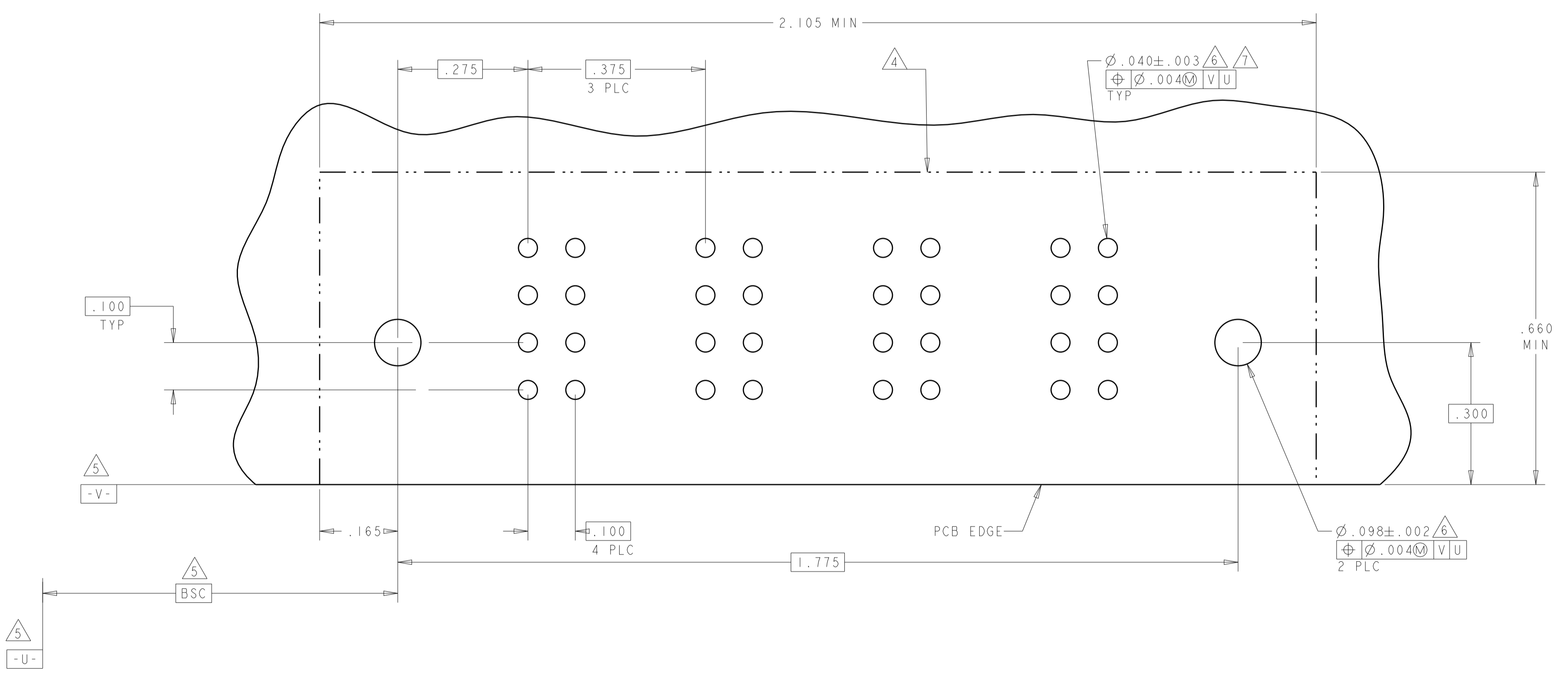

THIS DRAWING IS A CONTROLLED DOCUMENT.		DMN: R. GRZYBOWSKI / TOFEB05	TE Connectivity
DIMENSIONS: INCHES		CHK: M. PERCHERKE / TOFEB05	
TOLERANCES UNLESS OTHERWISE SPECIFIED:		APVD: M. PERCHERKE	NAME: RIGHT ANGLE HEADER ASSEMBLY W/GUIDES MULTI-BEAM XL
0 PLC ±.01	1 PLC ±.01	PRODUCT SPEC: 108-1973	SIZE: 114-13038
2 PLC ±.005	3 PLC ±.005	APPLICATION SPEC: 114-13038	RESTRICTED TO: -
4 PLC ±.0020	ANGLES ±.020	WEIGHT: -	SCALE: 4:1
MATERIAL: -	FINISH: -	CUSTOMER DRAWING: A100779	SHEET 7 OF 8
		CAGE CODE: C=6450123	REV: C6

LOC	DIST	REVISIONS			
P	LTN	DESCRIPTION	DATE	DMN	APVD
-	-	SEE SHEET 1	-	-	-

PART NUMBER	ROWS	POWER																
		P1	P2	P3	P4	P5	P6	P7	P8	P9	P10	P11	P12	P13	P14	P15	P16	P17
I-6450123-8	D C B A	PM																
		HD																
17P																		

FOR PART I-6450123-8 MAX OPERATING VOLTAGE: 480VAC AND WITHSTAND HOT PLUG WITH 480VAC 0.1A

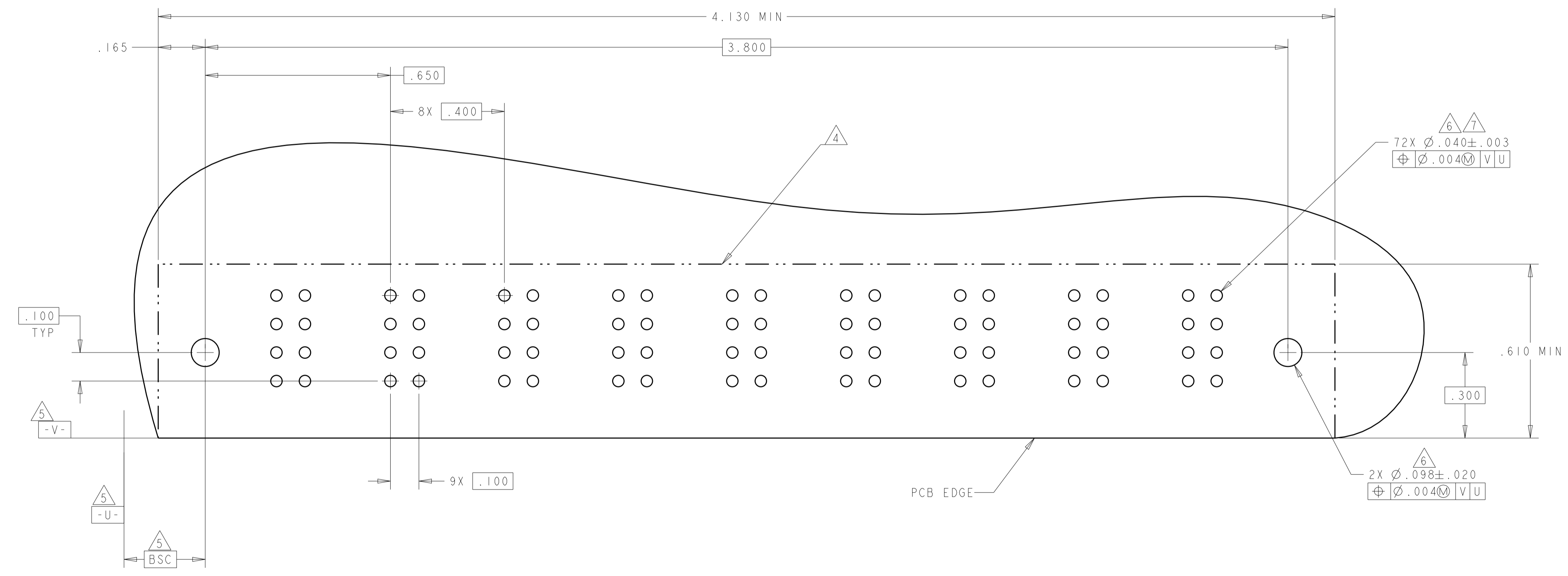
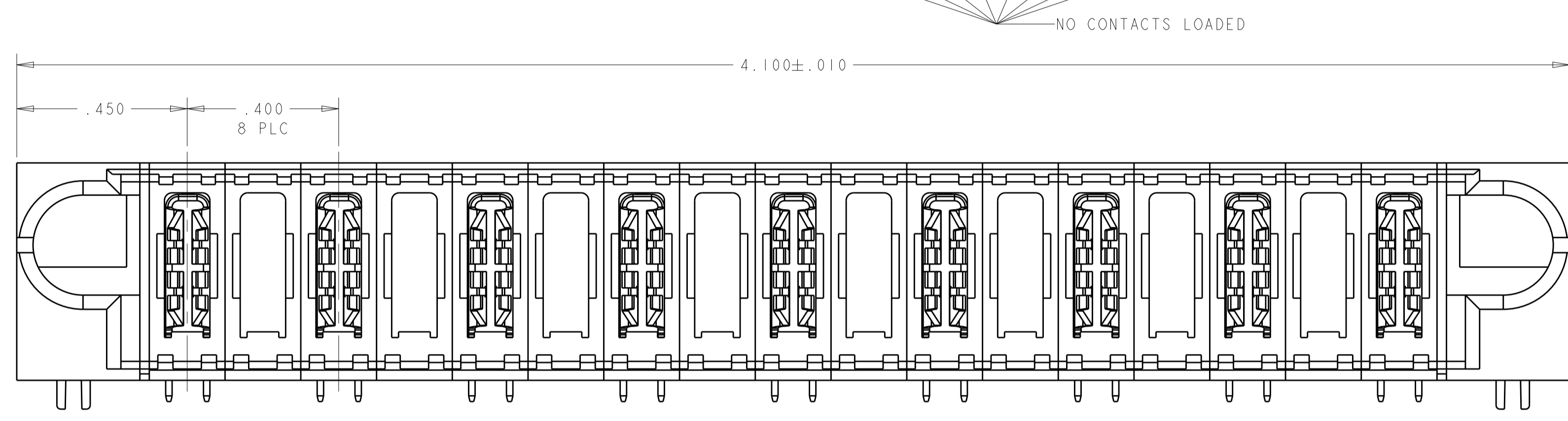

THIS DRAWING IS A CONTROLLED DOCUMENT.		DMN R. GRZYBOWSKI	10FEB05	TE Connectivity
DIMENSIONS: INCHES		CHK M. PERCHERKE	10FEB05	
TOLERANCES UNLESS OTHERWISE SPECIFIED: 0 PLC ±. 1 PLC ±.01 2 PLC ±.01 3 PLC ±.005 4 PLC ±.0020 ANGLES ±.2°		APVD M. PERCHERKE	NAME RIGHT ANGLE HEADER ASSEMBLY W/GUIDES MULTI-BEAM XL	SIZE CAGE CODE DRAWING NO A100779 C=6450123
MATERIAL		PRODUCT SPEC 108-1973	APPLICATION SPEC 114-13038	
FINISH		WEIGHT	CUSTOMER DRAWING	SCALE 4:1 SHEET 8 OF 8 REV C6

Компания «Life Electronics» занимается поставками электронных компонентов импортного и отечественного производства от производителей и со складов крупных дистрибьюторов Европы, Америки и Азии.

С конца 2013 года компания активно расширяет линейку поставок компонентов по направлению коаксиальный кабель, кварцевые генераторы и конденсаторы (керамические, пленочные, электролитические), за счёт заключения дистрибьюторских договоров

Мы предлагаем:

- Конкурентоспособные цены и скидки постоянным клиентам.
- Специальные условия для постоянных клиентов.
- Подбор аналогов.
- Поставку компонентов в любых объемах, удовлетворяющих вашим потребностям.
- Приемлемые сроки поставки, возможна ускоренная поставка.
- Доставку товара в любую точку России и стран СНГ.
- Комплексную поставку.
- Работу по проектам и поставку образцов.
- Формирование склада под заказчика.
- Сертификаты соответствия на поставляемую продукцию (по желанию клиента).
- Тестирование поставляемой продукции.
- Поставку компонентов, требующих военную и космическую приемку.
- Входной контроль качества.
- Наличие сертификата ISO.

В составе нашей компании организован Конструкторский отдел, призванный помогать разработчикам, и инженерам.

Конструкторский отдел помогает осуществить:

- Регистрацию проекта у производителя компонентов.
- Техническую поддержку проекта.
- Защиту от снятия компонента с производства.
- Оценку стоимости проекта по компонентам.
- Изготовление тестовой платы монтаж и пусконаладочные работы.



Тел: +7 (812) 336 43 04 (многоканальный)

Email: org@lifeelectronics.ru