

16-Ball WLCS Package Option 1: iCE40 LP

Dimensions in Millimeters

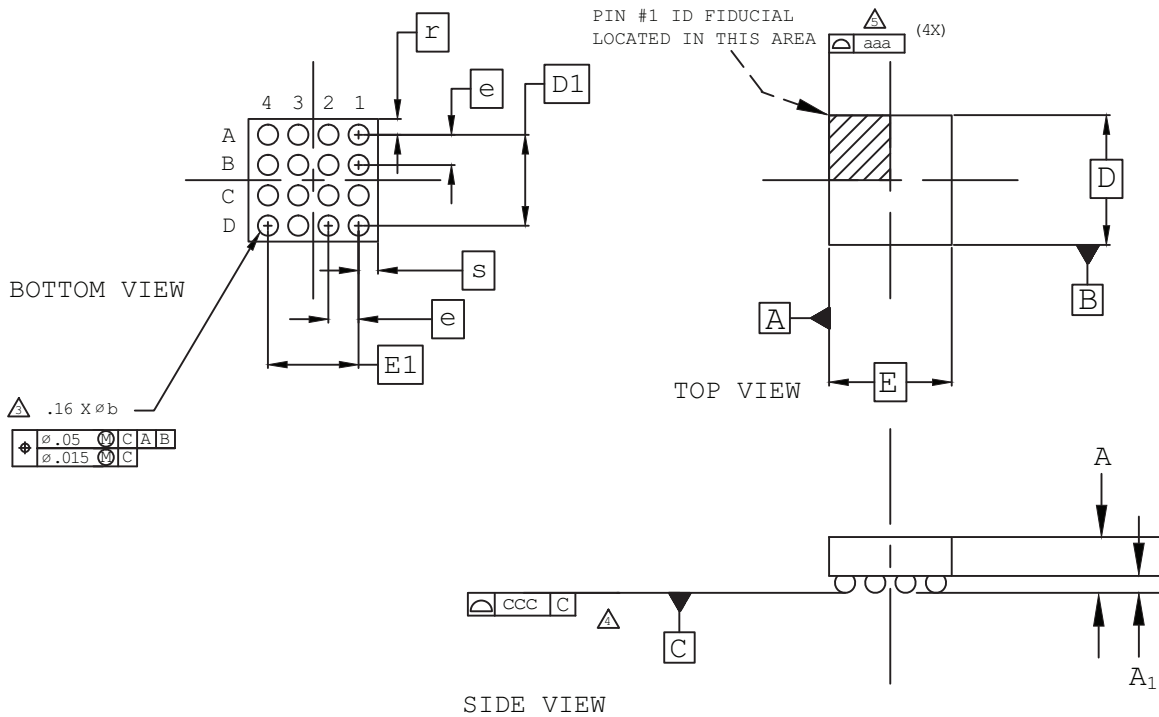

NOTES:

1. ALL DIMENSIONS AND TOLERANCE PER ASME Y 14.5M - 1994.
2. ALL DIMENSIONS ARE IN MILLIMETERS.

Δ DIMENSION "b" IS MEASURES AT THE MAXIMUM BUMP DIAMETER PARALLEL TO PRIMARY DATUM C.

Δ PRIMARY DATUM C AND SEATING PLANE ARE DEFINED BY THE SPHERICAL CROWNS OF THE SOLDER BUMPS.

Δ BILATERAL TOLERANCE ZONE IS APPLIED TO EACH SIDE OF THE PACKAGE BODY.

REF.	Min.	Nom.	Max.
A	0.413	0.452	0.491
A1	0.122	0.152	0.182
b	0.188	0.218	0.248
D	1.40 BSC		
E	1.48 BSC		
D1	1.05 BSC		
E1	1.05 BSC		
e	0.35 BSC		
aaa	0.03		
ccc	0.03		
r	-	0.175	-
s	-	0.215	-

16-Ball WLCS Package Option 2: iCE40 UltraLite™

Dimensions in Millimeters

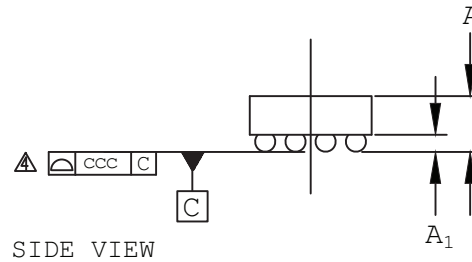
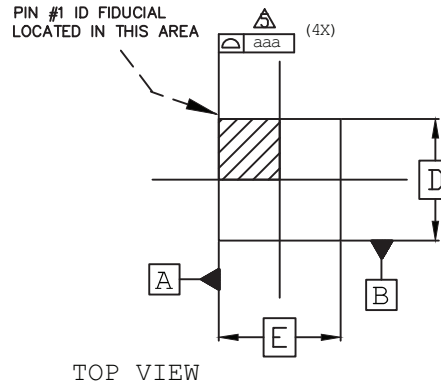
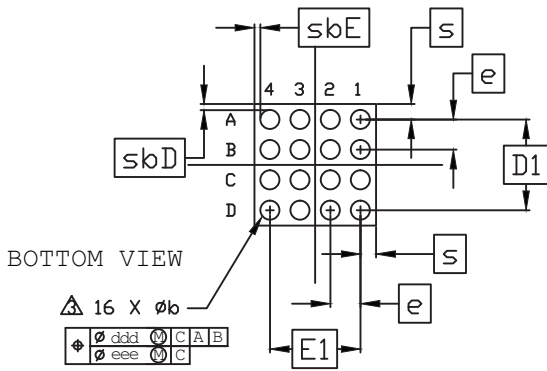

NOTES:

1. ALL DIMENSIONS AND TOLERANCE PER ASME Y 14.5M - 1994.

2. ALL DIMENSIONS ARE IN MILLIMETERS.

△ DIMENSION "b" IS MEASURES AT THE MAXIMUM BUMP DIAMETER PARALLEL TO PRIMARY DATUM C.

△ PRIMARY DATUM C AND SEATING PLANE ARE DEFINED BY THE SPHERICAL CROWNS OF THE SOLDER BUMPS.

△ BILATERAL TOLERANCE ZONE IS APPLIED TO EACH SIDE OF THE PACKAGE BODY.

REF.	Min.	Nom.	Max.
A	0.413	0.452	0.491
A1	0.122	0.152	0.182
b	0.188	0.218	0.248
D	1.409 BSC		
E	1.409 BSC		
D1	1.05 BSC		
E1	1.05 BSC		
e	0.35 BSC		
s	-	0.180	-
sbD	0.067	0.071	0.072
sbE	0.067	0.071	0.072
aaa	0.03		
ccc	0.03		
ddd	0.050		
eee	0.015		

20-Pin (300-Mil) CERDIP Package

Dimensions in Inches

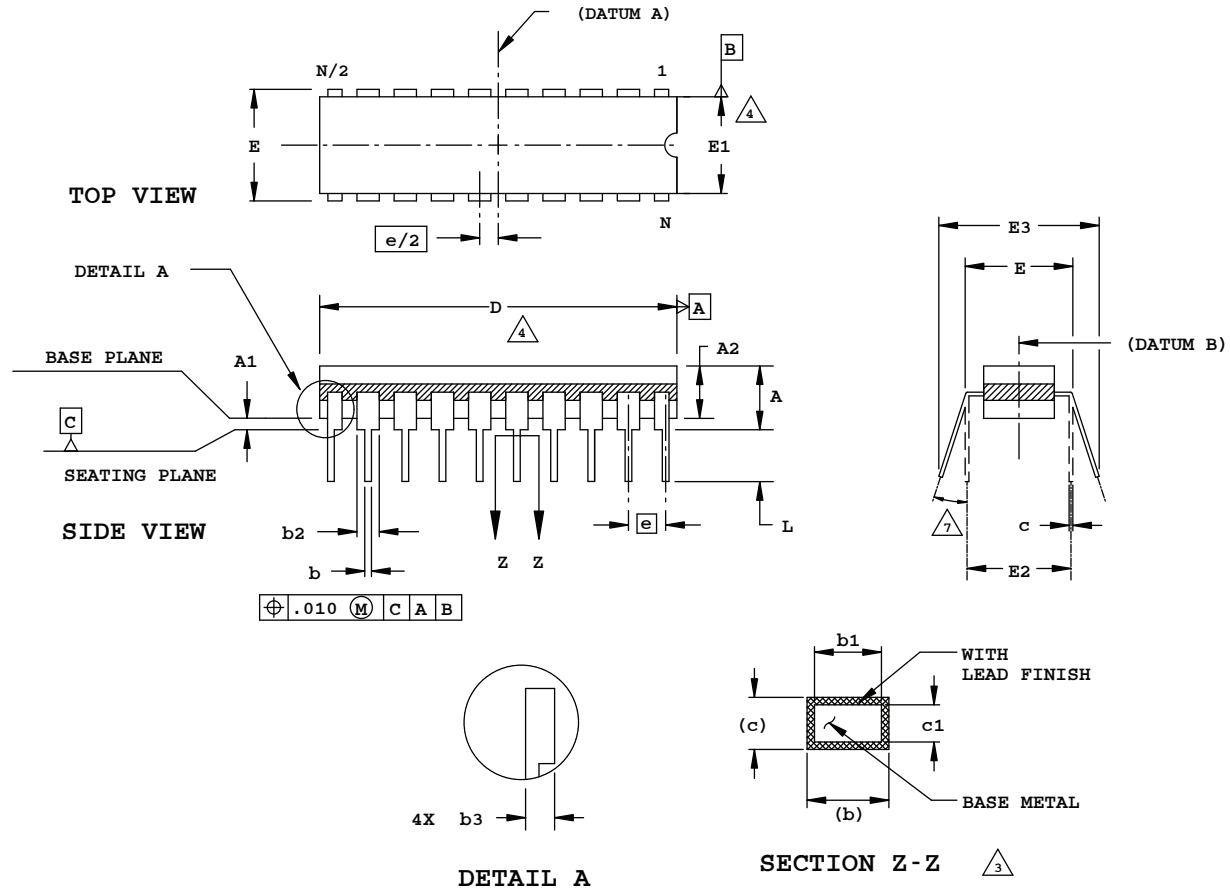

NOTES:

- DIMENSIONING AND TOLERANCING PER ANSI Y14.5M.
- ALL DIMENSIONS ARE IN INCHES.
- MEASUREMENTS TO BE TAKEN AT A MINIMUM OF .060 INCHES FROM THE LEAD TIP.
- DIMENSIONS D AND E1 INCLUDE ALLOWANCE FOR GLASS OVERRUN AND MENISCUS, AND LID TO BASE MISMATCH.
- DIMENSIONS A, A1 AND L ARE MEASURED WITH THE PACKAGE SEATED IN JEDEC SEATING PLANE GAUGE GS-003.
- E3 IS TO BE MEASURED AT THE LEAD TIPS.
- ALLOWED LEAD TIP POSITION RANGE.

SYMBOL	INCHES		
	MIN.	NOM.	MAX.
A	-	-	.200
A1	.015	-	-
A2	.140	-	.175
b	.015	-	.023
b1	.015	.018	.021
b2	.045	-	.065
b3	.023	-	.045
c	.008	-	.014
c1	.008	.010	.012
D	.942	.950	.970
E	.308	-	.325
E1	.280	.288	.296
E2	.300 REF		
E3	.325	-	.410
e	.100 BSC		
L	.125	-	.200
N	20		

20-Pin LCC Package

Dimensions in Inches

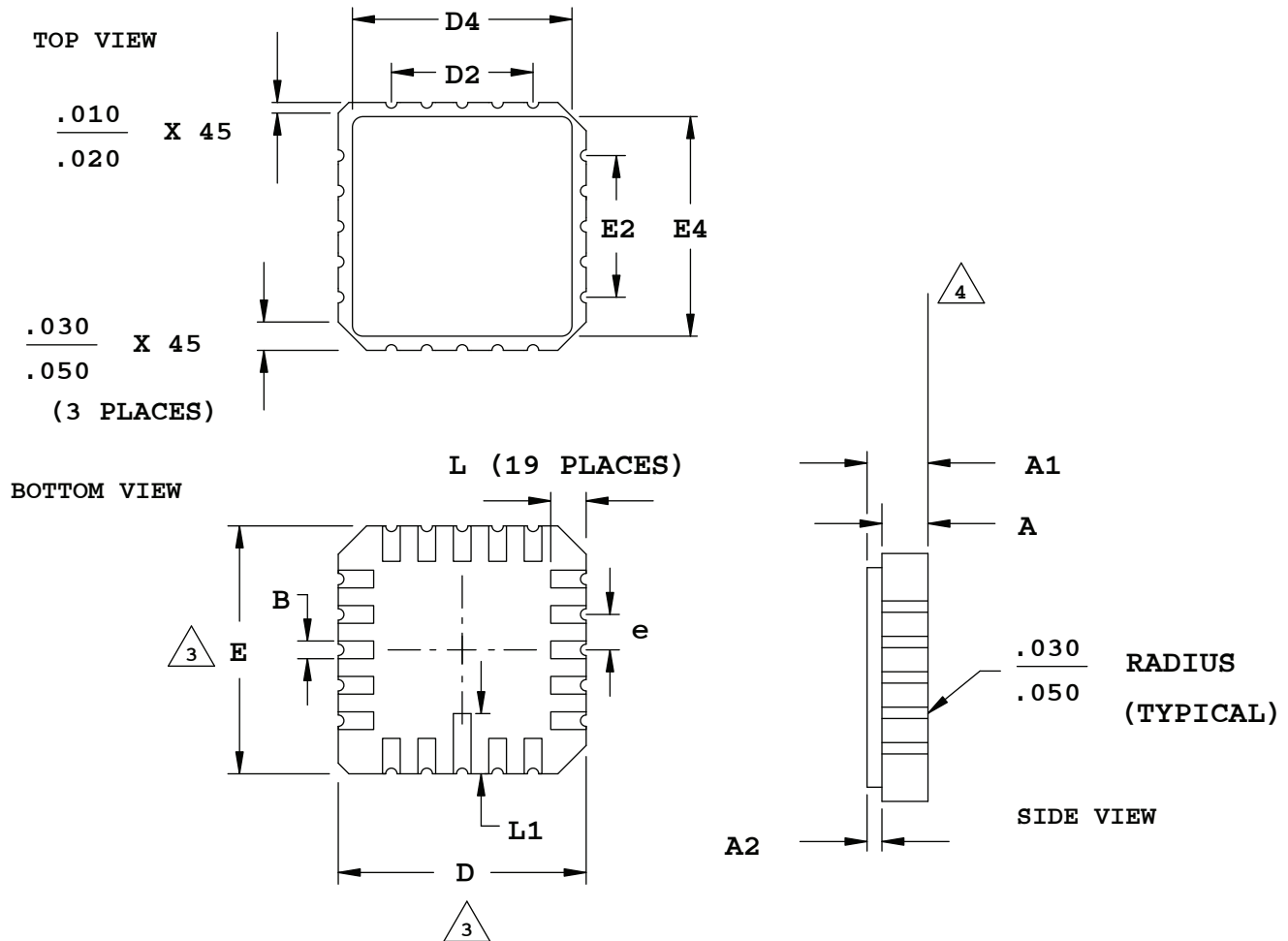

NOTES:

1. DIMENSIONING AND TOLERANCING PER ANSI Y14.5.
2. ALL DIMENSIONS ARE IN INCHES.

3. DIMENSIONS D AND E MAY HAVE MATERIAL PROTRUSION OF .010 INCHES MAXIMUM ABOVE THE DIMENSION SHOWN NOT TO EXCEED .005 INCHES MAXIMUM PER SIDE.

4. FLATNESS TOLERANCE IS .004 INCHES PER INCH.

SYMBOL	INCHES	
	MIN.	MAX.
A	.054	.074
A1	.064	.089
A2	.007	.015
B	.022	.028
D	.342	.358
D2	.200	
D4	.270	.315
E	.342	.358
E2	.200	
E4	.270	.315
e	.050 BSC	
L	.042	.058
L1	.075	.095

20-Pin PLCC Package

Dimensions in Inches

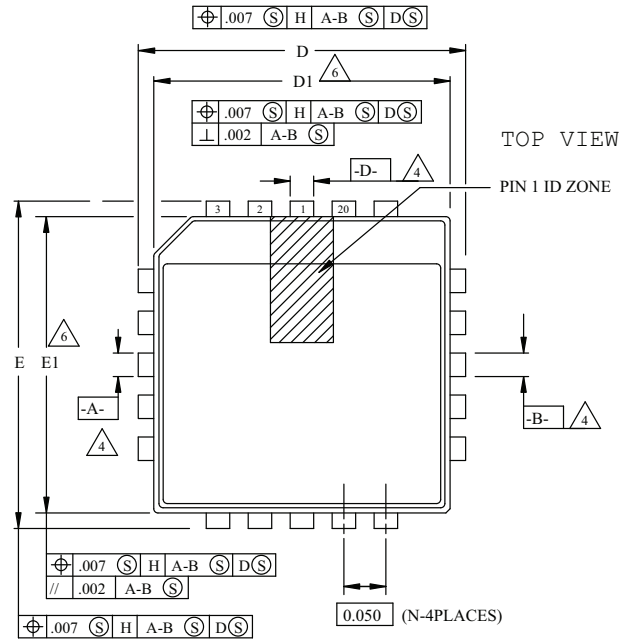
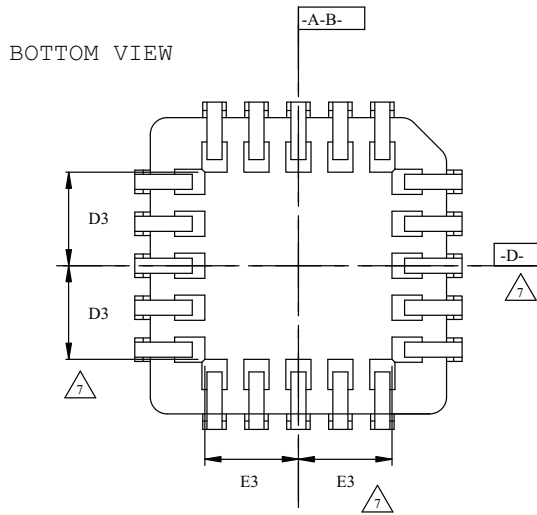

SYMBOL	DIMENSIONS		
	MIN.	NOM.	MAX.
A	.165	.172	.180
A1	.090	.105	.120
A2	.062	-	.083
D	.385	.390	.395
D1	.350	.353	.356
D2	.141	.155	.169
D3		.075	
E	.385	.390	.395
E1	.350	.353	.356
E2	.141	.155	.169
E3		.075	
N	20		

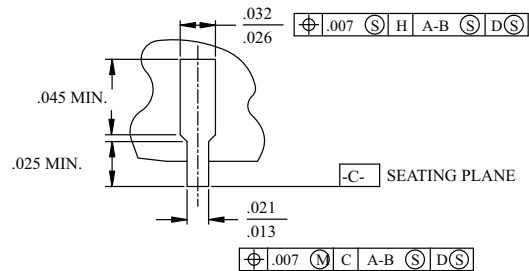
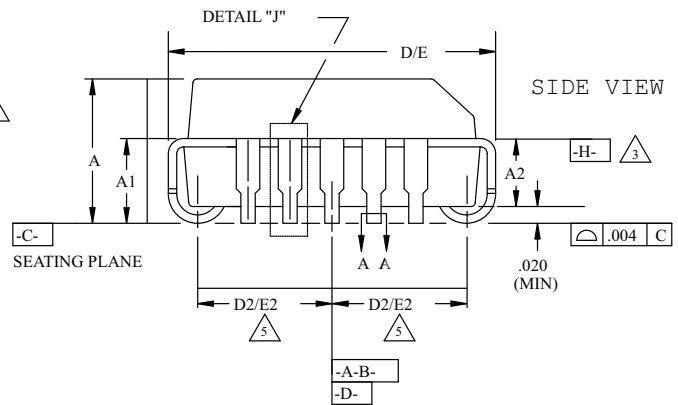
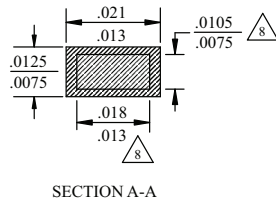

NOTES:

- ALL DIMENSIONS AND TOLERANCES CONFORM TO ANSI Y14.5M-1982
- ALL DIMENSIONS IN INCHES
- DATUM PLANE \square LOCATED AT TOP OF MOLD PARTING LINE AND COINCIDENT WITH TOP OF LEAD WHERE LEAD EXITS PLASTIC BODY
- DATUMS \square AND \square TO BE DETERMINED WHERE CENTER LEADS EXIT PLASTIC BODY AT DATUM PLANE \square
- TO BE MEASURED AT SEATING PLANE \square CONTACT POINT
- DIMENSIONS D1 AND E1 DO NOT INCLUDE MOLD PROTRUSION. ALLOWABLE PROTRUSION IS .010 PER SIDE.
- TOP POINT OF MEASUREMENT IS DATUM \square ; BOTTOM POINT OF MEASUREMENT IS AT MAJOR FLAT AREA OF LOWER PLASTIC SURFACE DEFINED BY D3/E3
- DIMENSION APPLIES TO BASE METAL ONLY

DETAIL "J" (TYP ALL SIDES)

20-Pin Plastic DIP Package

Dimensions in Inches

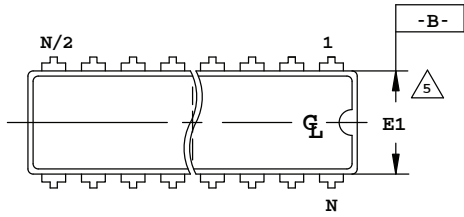

TOP VIEW

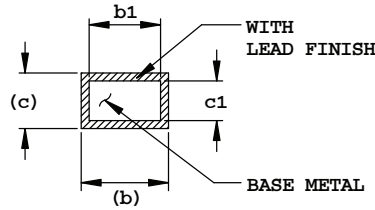

SECTION Z-Z

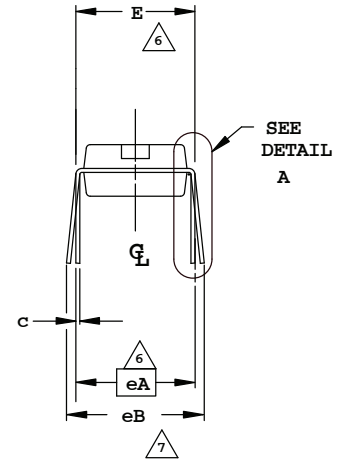

SEE
DETAIL
A

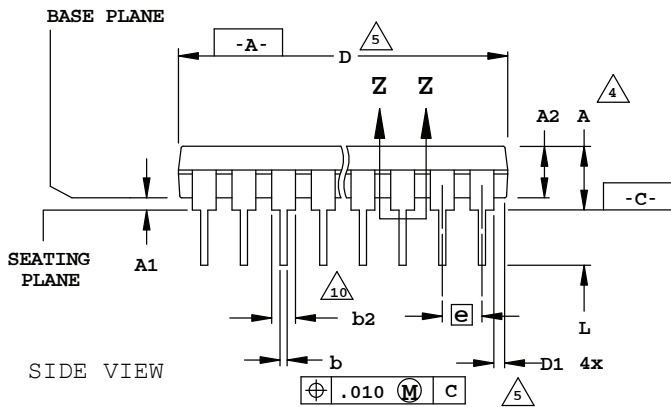

SIDE VIEW

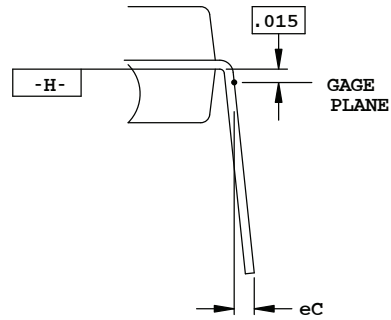

DETAIL A

NOTES:

1. CONTROLLING DIMENSION: INCH.
2. DIMENSIONING AND TOLERANCING PER ANSI Y14.5M
3. DISTANCE BETWEEN LEADS INCLUDING DAMBAR PROTRUSIONS TO BE .005 MINIMUM.
4. DIMENSIONS A, A1 & L ARE MEASURED WITH THE PACKAGE SEATED IN JEDEC SEATING PLANE GAUGE GS-3.
5. DIMENSIONS D, D1 AND E1 DO NOT INCLUDE MOLD FLASH OR PROTRUSIONS. MOLD FLASH OR PROTRUSIONS SHALL NOT EXCEED .010
6. E AND eA MEASURED WITH THE LEADS CONSTRAINED TO BE PERPENDICULAR TO DATUM -C-
7. eB AND eC ARE MEASURED AT THE LEAD TIPS WITH THE LEADS UNCONSTRAINED.
8. N IS THE MAXIMUM NUMBER OF LEAD POSITIONS.
9. POINTED OR ROUNDED LEAD TIPS ARE PREFERRED TO EASE INSERTION
10. b2 MAXIMUM DIMENSION DOES NOT INCLUDE DAMBAR PROTRUSIONS. DAMBAR PROTRUSIONS SHALL NOT EXCEED .010
11. DATUM PLANE -H- COINCIDENT WITH THE BOTTOM OF LEAD, WHERE LEAD EXITS BODY

		N = 20			
SYMBOL	UNIT	INCHES			NOTES
		MIN.	NOM.	MAX.	
A	-	-	-	.210	4
A1	.015	-	-	-	4
A2	.115	.130	.195	-	-
b	.014	.018	.022	-	-
b1	.014	.018	.020	-	-
b2	.045	.060	.070	10	-
c	.008	.010	.014	-	-
c1	.008	.010	.011	-	-
D	.980	1.030	1.060	5	-
D1	.005	-	-	5	-
E	.300	.310	.325	6	-
E1	.240	.250	.280	5	-
e	.100 BSC			-	-
eA	.300 BSC			-	6
eB	-	-	.430	7	-
eC	.000	-	.060	7	-
L	.115	.130	.150	4	-

24-Pin (300-Mil) CERDIP

Dimensions in Inches

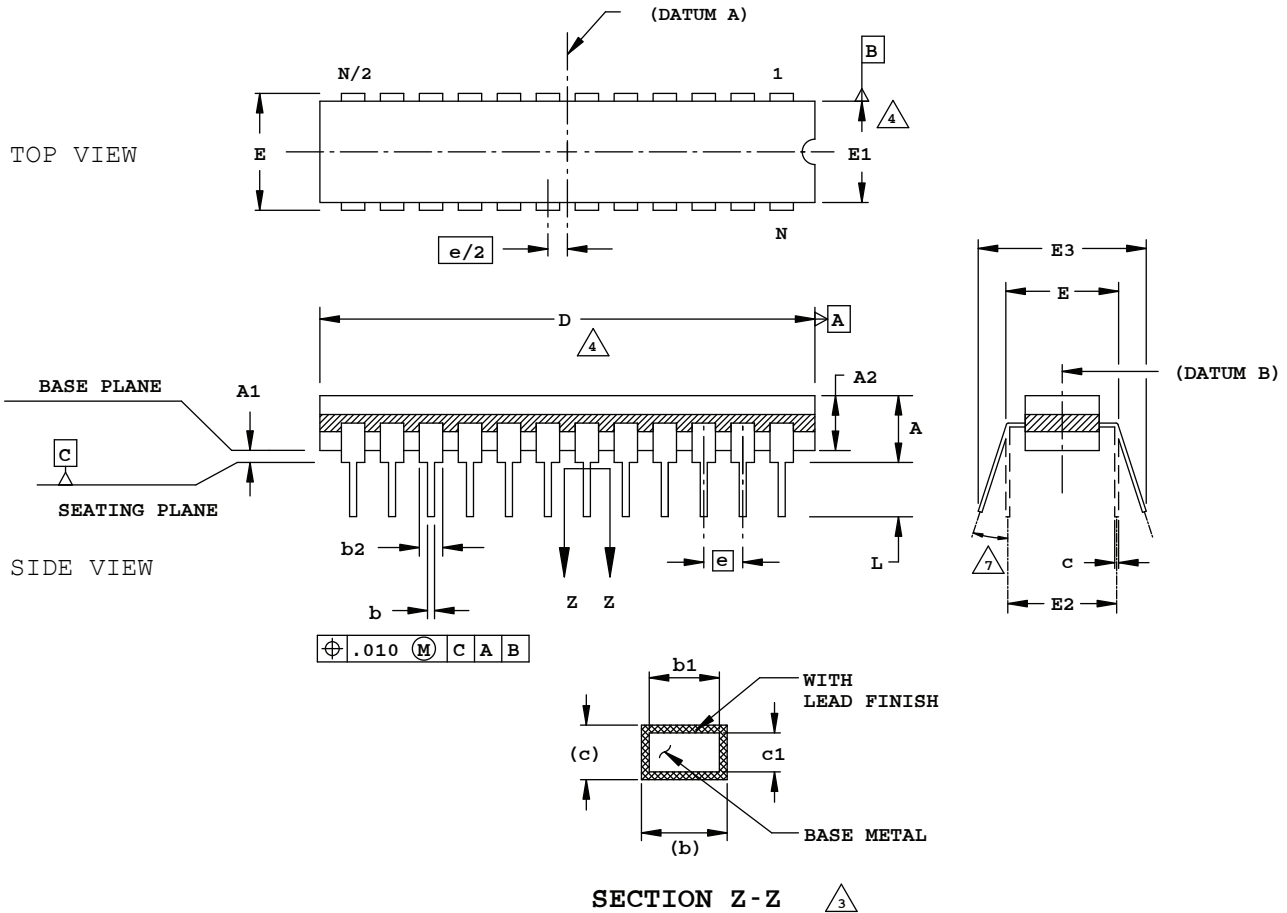

NOTES:

1. DIMENSIONING AND TOLERANCING PER ANSI Y14.5M.
2. ALL DIMENSIONS ARE IN INCHES.
3. MEASUREMENTS TO BE TAKEN AT A MINIMUM OF .060 INCHES FROM THE LEAD TIP.
4. DIMENSIONS D AND E1 INCLUDE ALLOWANCE FOR GLASS OVERRUN AND MENISCUS, AND LID TO BASE MISMATCH.
5. DIMENSIONS A, A1 AND L ARE MEASURED WITH THE PACKAGE SEATED IN JEDEC SEATING PLANE GAUGE GS-003.
6. E3 IS TO BE MEASURED AT THE LEAD TIPS.
7. ALLOWED LEAD TIP POSITION RANGE.

SYMBOL	INCHES		
	MIN.	NOM.	MAX.
A	-	-	.200
A1	.015	-	-
A2	.140	-	.175
b	.015	-	.023
b1	.015	.018	.021
b2	.045	-	.065
c	.008	-	.014
c1	.008	.010	.012
D	1.242	1.250	1.270
E	.308	-	.325
E1	.280	.288	.296
E2	.300 REF		
E3	.325	-	.410
e	.100 BSC		
L	.125	-	.200
N	24		

24-Pin Plastic DIP

Dimensions in Inches

TOP VIEW

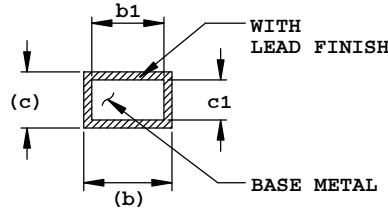
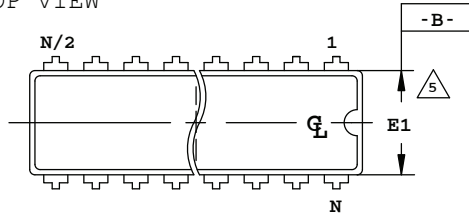

SECTION Z-Z

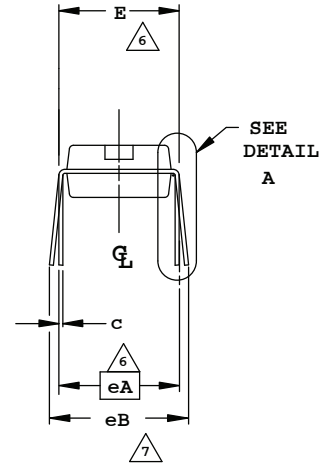

SEE
DETAIL
A

SIDE VIEW

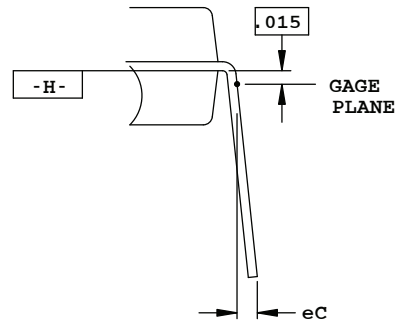
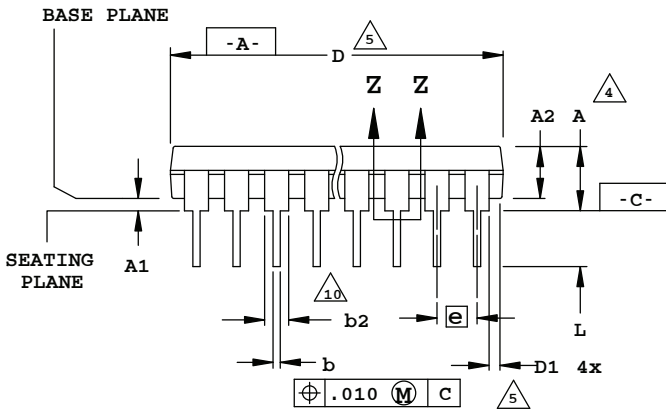

DETAIL A

NOTES:

1. CONTROLLING DIMENSION: INCH.
2. DIMENSIONING AND TOLERANCING PER ANSI Y14.5M
3. DISTANCE BETWEEN LEADS INCLUDING DAMBAR PROTRUSIONS TO BE .005 MINIMUM.
4. DIMENSIONS A, A1 & L ARE MEASURED WITH THE PACKAGE SEATED IN JEDEC SEATING PLANE GAUGE GS-3.
5. DIMENSIONS D, D1 AND E1 DO NOT INCLUDE MOLD FLASH OR PROTRUSIONS. MOLD FLASH OR PROTRUSIONS SHALL NOT EXCEED .010
6. E AND eA MEASURED WITH THE LEADS CONSTRAINED TO BE PERPENDICULAR TO DATUM -C-
7. eB AND eC ARE MEASURED AT THE LEAD TIPS WITH THE LEADS UNCONSTRAINED.
8. N IS THE MAXIMUM NUMBER OF LEAD POSITIONS.
9. POINTED OR ROUNDED LEAD TIPS ARE PREFERRED TO EASE INSERTION
10. b2 MAXIMUM DIMENSIONS DOES NOT INCLUDE DAMBAR PROTRUSIONS. DAMBAR PROTRUSIONS SHALL NOT EXCEED .010
11. DATUM PLANE -H- COINCIDENT WITH THE BOTTOM OF LEAD, WHERE LEAD EXITS BODY

		N = 24				
A V W B D E		INCHES			H O S E	E
		MIN.	NOM.	MAX.		
A	-	-	.210	4		
A1	.015	-	-	4		
A2	.115	.130	.195			
b	.014	.018	.022			
b1	.014	.018	.020			
b2	.045	.060	.070	10		
c	.008	.010	.014			
c1	.008	.010	.011			
D	1.230	1.250	1.280	5		
D1	.005	-	-	5		
E	.300	.310	.325	6		
E1	.240	.250	.280	5		
e		.100	BSC			
eA		.300	BSC	6		
eB	-	-	.430	7		
eC	.000	-	.060	7		
L	.115	.130	.150			

24-Pin QFNS Package

Dimensions in Millimeters

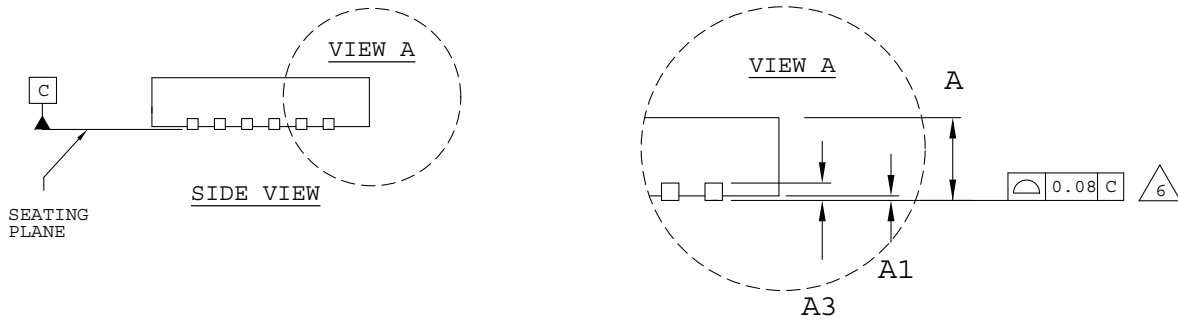
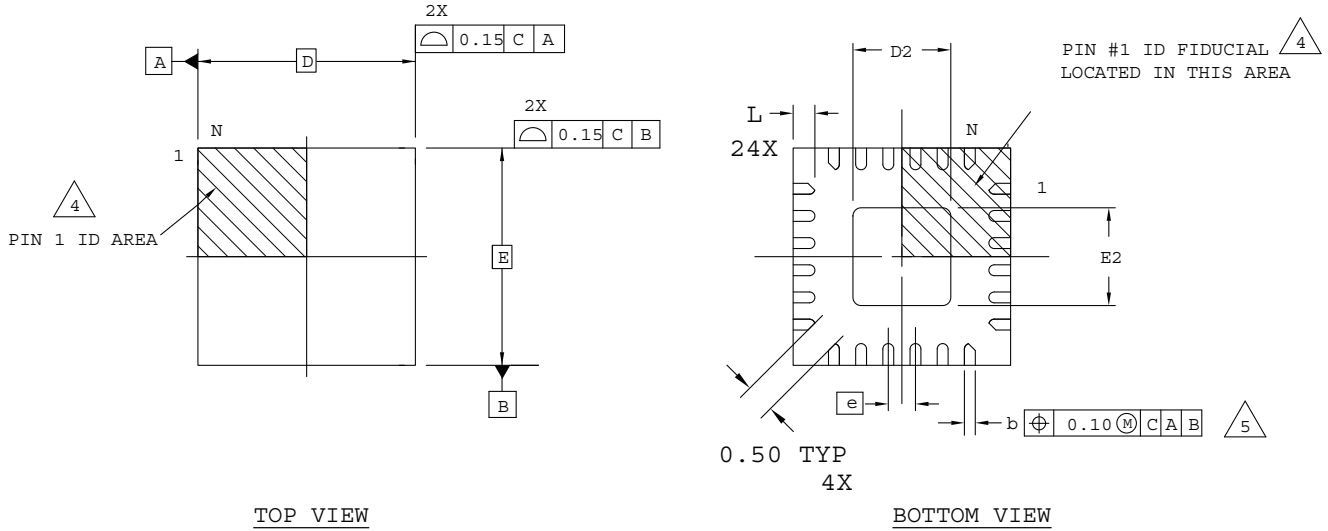

NOTES: UNLESS OTHERWISE SPECIFIED

1. DIMENSIONS AND TOLERANCES PER ANSI Y14.5M.
2. ALL DIMENSIONS ARE IN MILLIMETERS.
3. DRAWING CONFORMS TO JEDEC MO-220, VARIATION VGGD-9.

EXACT SHAPE AND SIZE OF THIS FEATURE IS OPTIONAL.

DIMENSION b APPLIES TO PLATED TERMINAL AND IS MEASURED BETWEEN 0.15 AND 0.30 mm FROM TERMINAL TIP.

APPLIES TO EXPOSED PORTION OF TERMINALS.

SYMBOL	MIN.	NOM.	MAX.
A	0.80	0.90	1.00
A1	0.00	0.02	0.05
A3	0.2 REF		
D	4.0 BSC		
D2	1.05	-	2.45
E	4.0 BSC		
E2	1.05	-	2.45
b	0.18	0.25	0.30
e	0.50 BSC		
L	0.45	0.50	0.55

25-Ball WLCS Package (0.40 mm Pitch)

Dimensions in Millimeters

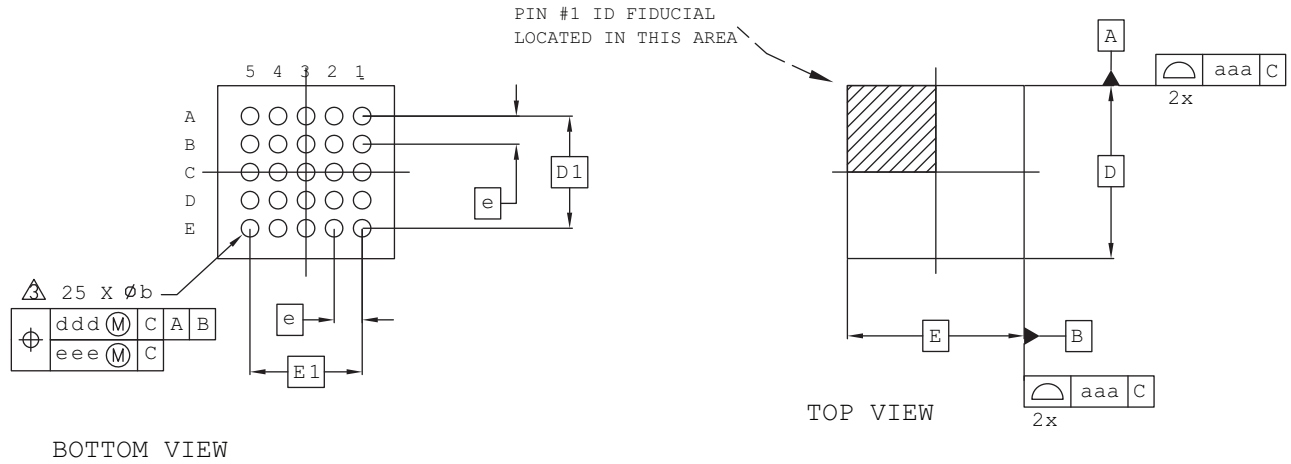

Notes:

- 1 ALL DIMENSIONS AND TOLERANCE PER ASME Y 14.5M - 1994.
- 2 ALL DIMENSIONS ARE IN MILLIMETERS.
- Δ DIMENSION "b" IS MEASURED AT THE MAXIMUM BUMP DIAMETER PARALLEL TO PRIMARY DATUM C.
- Δ PRIMARY DATUM C AND SEATING PLANE ARE DEFINED BY THE SPHERICAL CROWNS OF THE SOLDER BUMPS.

REF.	Min.	Nom.	Max.
A	0.535	0.575	0.615
A1	0.170	0.200	0.230
b	0.220	0.250	0.280
D	2.492 BSC		
E	2.546 BSC		
D1	1.60 BSC		
E1	1.60 BSC		
e	0.40 BSC		
aaa	0.025		
bbb	0.060		
ccc	0.015		
ddd	0.150		
eee	0.050		

25-Ball WLCS Package (0.35 mm Pitch)

Dimensions in Millimeters

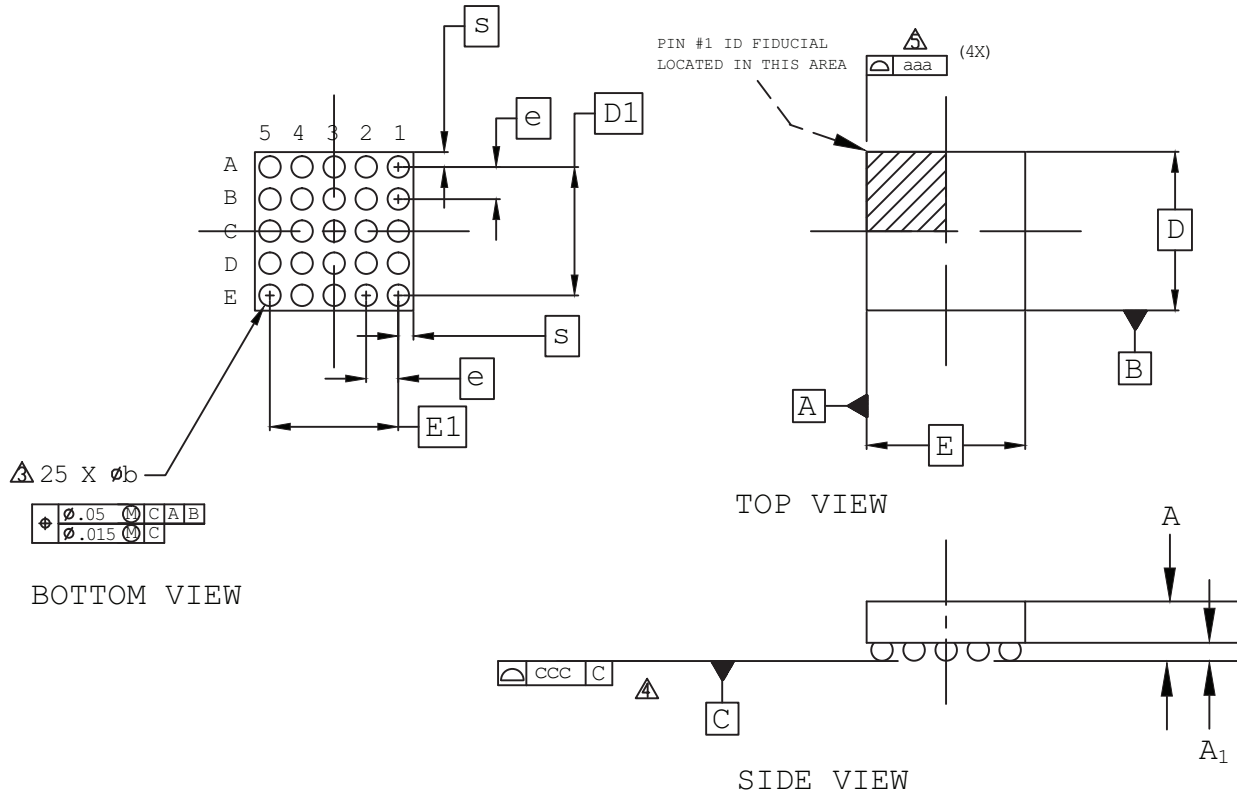

Notes:

- 1 ALL DIMENSIONS AND TOLERANCE PER ASME Y 14.5M - 1994.
- 2 ALL DIMENSIONS ARE IN MILLIMETERS.
- △ DIMENSION "b" IS MEASURED AT THE MAXIMUM BUMP DIAMETER PARALLEL TO PRIMARY DATUM C.
- △ PRIMARY DATUM C AND SEATING PLANE ARE DEFINED BY THE SPHERICAL CROWNS OF THE SOLDER BUMPS.
- △ BILATERAL TOLERANCE ZONE IS APPLIED TO EACH SIDE OF THE PACKAGE BODY.

REF.	Min.	Nom.	Max.
A	0.413	0.452	0.491
A1	0.122	0.152	0.182
b	0.188	0.218	0.248
D	1.71 BSC		
E	1.71 BSC		
D1	1.40 BSC		
E1	1.40 BSC		
e	0.35 BSC		
aaa	0.03		
ccc	0.03		
s	-	0.015	-

28-Pin LCC Package

Dimensions in Inches

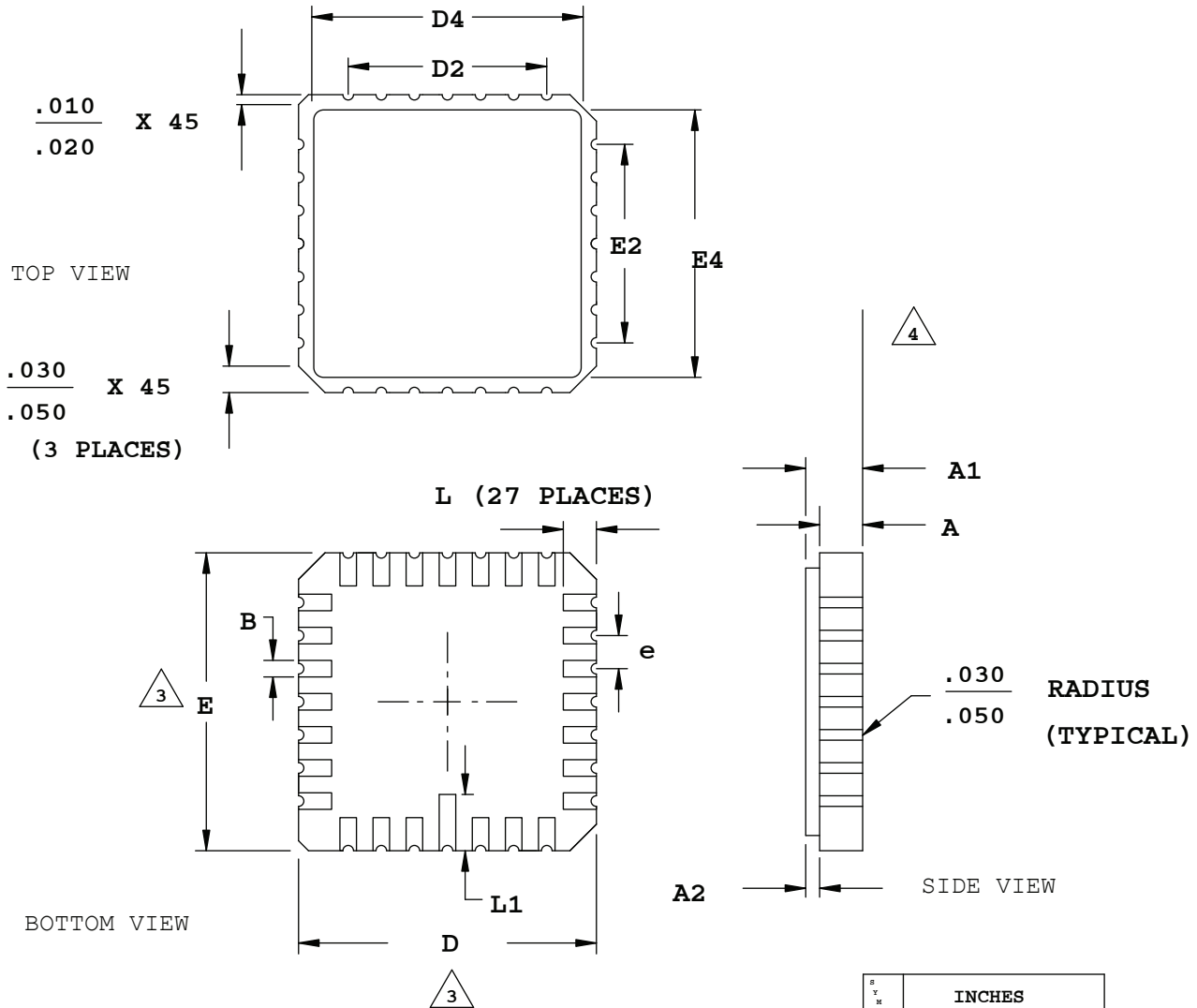

NOTES:

1. DIMENSIONING AND TOLERANCING PER ANSI Y14.5.
2. ALL DIMENSIONS ARE IN INCHES.

3. DIMENSIONS D AND E MAY HAVE MATERIAL PROTRUSION OF .010 INCHES MAXIMUM ABOVE THE DIMENSION SHOWN NOT TO EXCEED .005 INCHES MAXIMUM PER SIDE.

4. FLATNESS TOLERANCE IS .004 INCHES PER INCH.

SYMBOL	INCHES	
	MIN.	MAX.
A	.054	.074
A1	.064	.089
A2	.007	.015
B	.022	.028
D	.440	.460
D2	.300	
D4	.370	.403
E	.440	.460
E2	.300	
E4	.370	.403
e	.050 BSC	
L	.042	.058
L1	.075	.095

28-Pin PLCC Package

Dimensions in Inches

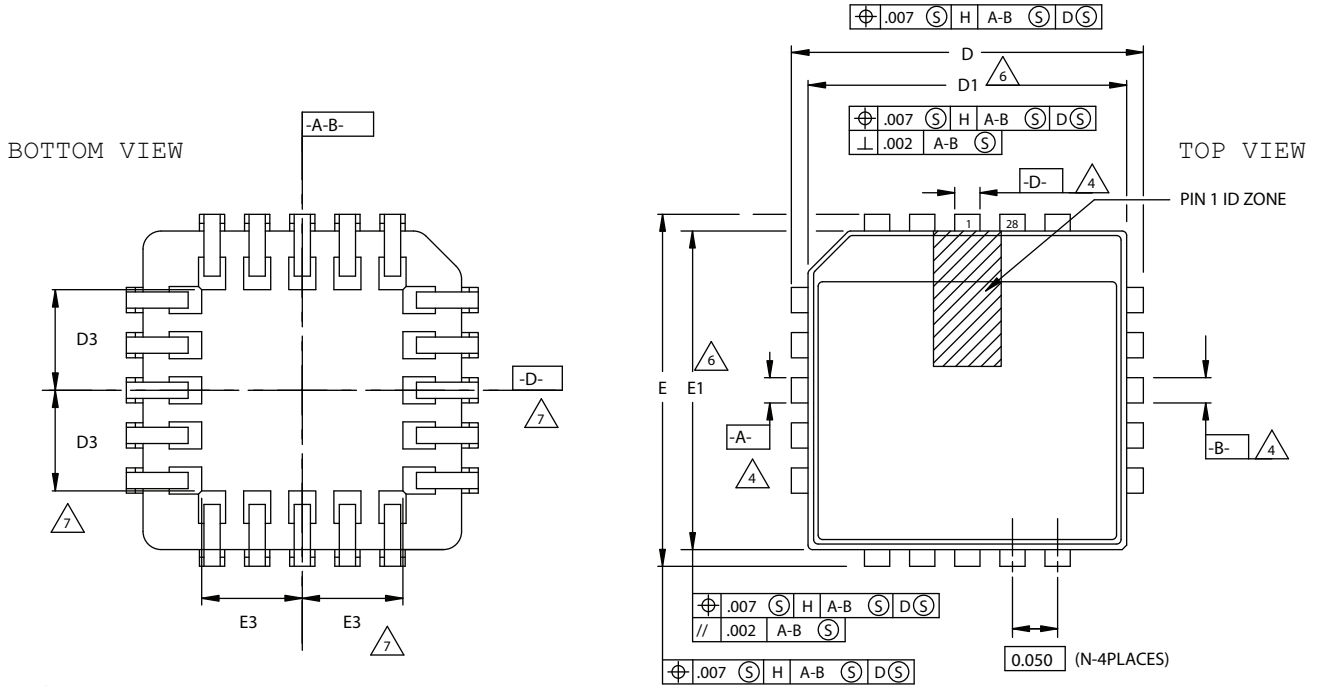

SYMBOL	MIN. NOM. MAX.		
	A	.165	.172
A1	.090	.105	.120
A2	.062	-	.083
D	.485	.490	.495
D1	.450	.453	.456
D2	.191	.205	.219
D3		.125	
E	.485	.490	.495
E1	.450	.453	.456
E2	.191	.205	.219
E3		.125	
N	28		

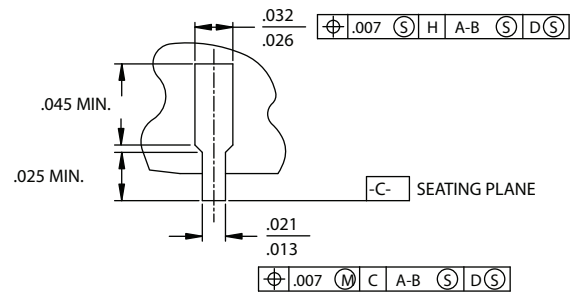
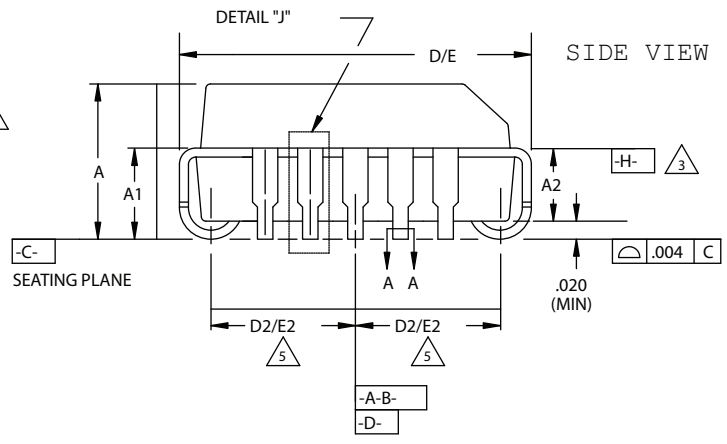
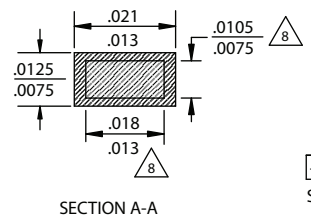

NOTES:

- ALL DIMENSIONS AND TOLERANCES CONFORM TO ANSI Y14.5M-1982
- ALL DIMENSIONS IN INCHES
- DATUM PLANE \square -H- LOCATED AT TOP OF MOLD PARTING LINE AND COINCIDENT WITH TOP OF LEAD WHERE LEAD EXITS PLASTIC BODY
- DATUMS \square -A-B AND \square -D- TO BE DETERMINED WHERE CENTER LEADS EXIT PLASTIC BODY AT DATUM PLANE \square -H-
- TO BE MEASURED AT SEATING PLANE \square -C- CONTACT POINT
- DIMENSIONS D1 AND E1 DO NOT INCLUDE MOLD PROTRUSION. ALLOWABLE PROTRUSION IS .010 PER SIDE.
- TOP POINT OF MEASUREMENT IS DATUM \square -H- ; BOTTOM POINT OF MEASUREMENT IS AT MAJOR FLAT AREA OF LOWER PLASTIC SURFACE DEFINED BY D3/E3
- DIMENSION APPLIES TO BASE METAL ONLY

DETAIL "J" (TYP ALL SIDES)

28-Pin Plastic DIP Package

Dimensions in Inches

TOP VIEW

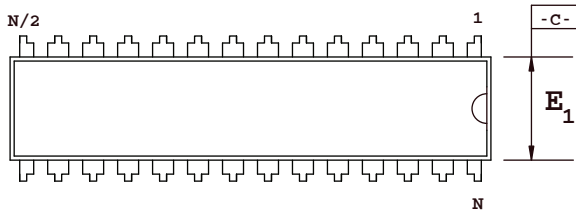

NOTE:

- 1 CONTROLLING DIMENSION: INCHES
- 2 DIMENSIONING AND TOLERANCING PER ANSI Y14.5M-1982
- 3 ALL END LEADS IN THIS FAMILY ARE 1/2 LEADS
- 4 DIMENSION A, A1, AND L ARE MEASURED WITH THE PACKAGE SEATED IN JEDEC SEATING PLANE GAUGE GS-3
- 5 D AND E1 DIMENSIONS DO NOT INCLUDE MOLD FLASH OR PROTRUSION. MOLD FLASH AND PROTRUSION SHALL NOT EXCEED 0.010
- 6 E AND eA MEASURED WITH THE LEADS CONSTRAINED TO BE PERPENDICULAR TO PLANE A
- 7 eB AND eC ARE MEASURED AT THE LEAD TIPS WITH THE LEADS UNCONSTRAINED. eC MUST BE ZERO OR GREATER
- 8 N IS THE NUMBER OF TERMINAL POSITIONS
- 9 B1 AND B2 MAXIMUM DIMENSIONS DO NOT INCLUDE DAMBAR PROTRUSIONS. DAMBAR PROTRUSIONS SHALL NOT EXCEED 0.010

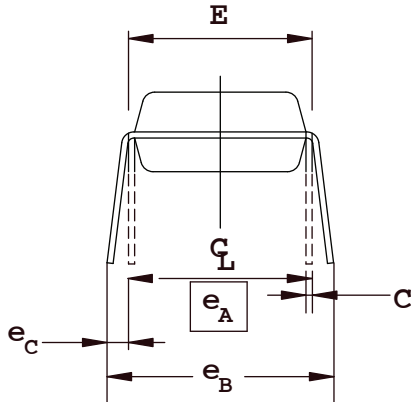

SIDE VIEW

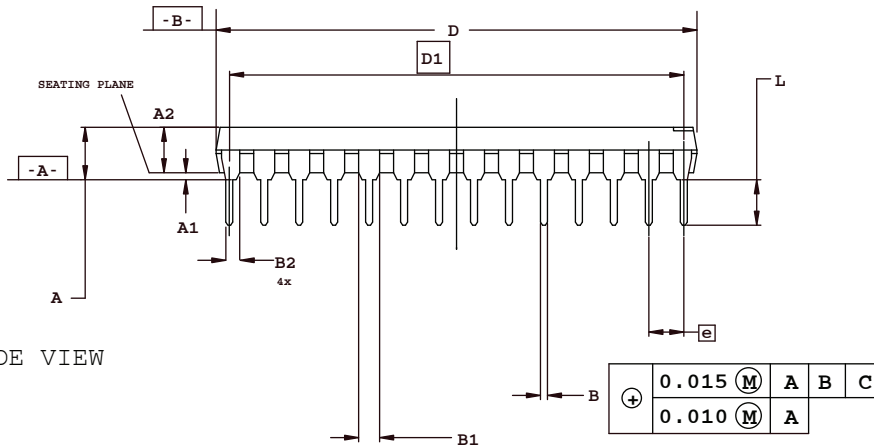

SYMBOL	INCHES		
	MIN.	NOM.	MAX.
A	-	-	.180
A ₁	.015	-	-
A ₂	.120	.135	.150
B	.014	.018	.022
B ₁	.045	.050	.060
B ₂	.030	.040	.045
C	.008	.010	.015
D	1.345	1.365	1.385
D1	1.300 BSC		
E	.300	.310	.325
E ₁	.275	.285	.295
e	.100 BSC		
e _A	.300 BSC		
e _B	-	-	.430
e _C	.000	-	.060
L	.110	.130	.150
N	28		

28-Pin SSOP Package

Dimensions in Millimeters

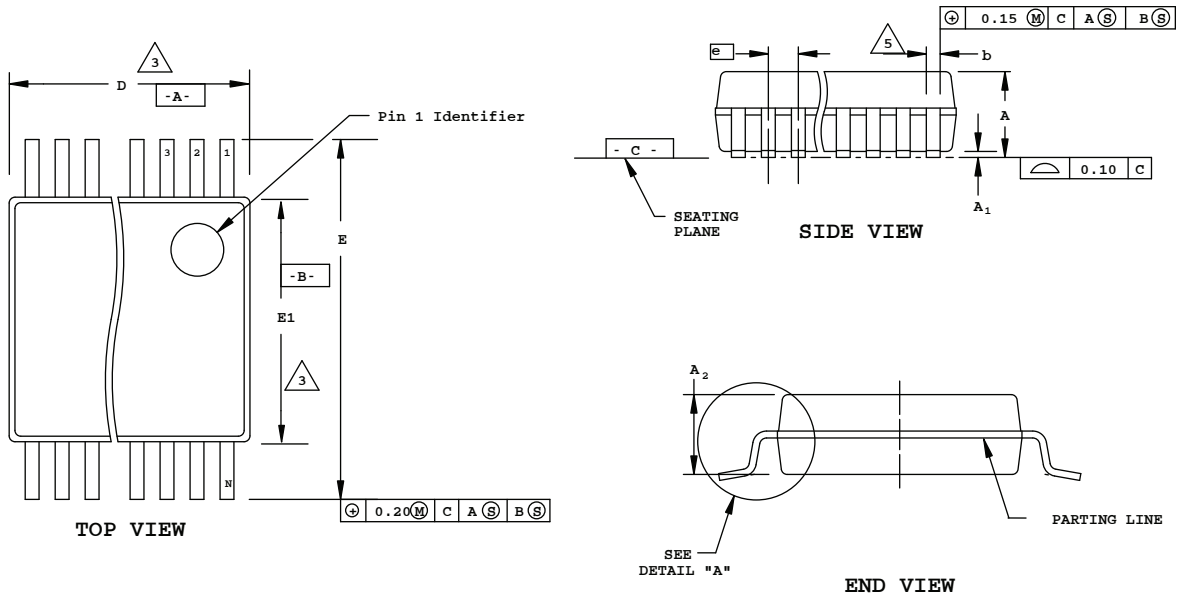

SYMBOL	COMMON DIMENSIONS		
	MIN.	NOM.	MAX.
A	--	--	2.0
A ₁	0.05	--	--
A ₂	1.65	1.75	1.85
b	0.22	-	0.38
b ₁	0.22	0.30	0.33
c	0.09	--	0.25
c ₁	0.09	0.15	0.21
D	9.90	10.20	10.50
E ₁	5.00	5.30	5.60
e	0.65 BSC		
E	7.40	7.80	8.20
L	0.55	0.75	0.95
L ₁	1.25 REF.		
N	28		
OC	0	4	8
R1	0.09	--	--

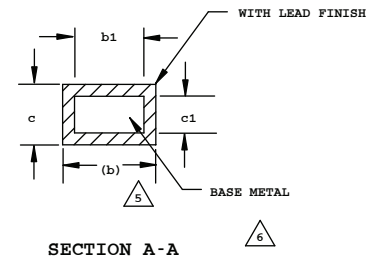
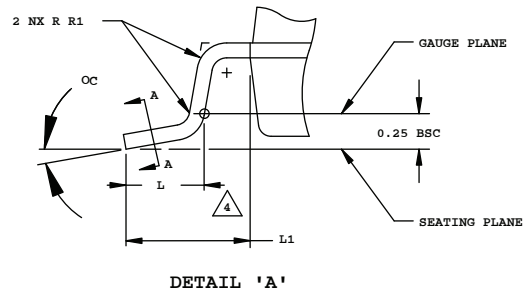

NOTES:

- CONTROLLING DIMENSION: MILLIMETERS.
- DIMENSIONING & TOLERANCES PER ANSI.Y14.5M-1982.

$\triangle 3$ "D" & "E₁" DO NOT INCLUDE MOLD FLASH OR PROTRUSIONS, BUT DO INCLUDE MOLD MISMATCH AND ARE MEASURED AT THE PARTING LINE. MOLD FLASH OR PROTRUSIONS SHALL NOT EXCEED 0.20mm PER SIDE.

$\triangle 4$ TO BE DETERMINED AT THE SEATING PLANE

$\triangle 5$ DIMENSION b DOES NOT INCLUDE DAMBAR PROTRUSION/INTRUSION. ALLOWABLE DAMBAR PROTRUSION SHALL BE 0.13mm TOTAL IN EXCESS OF b DIMENSION AT MAXIMUM MATERIAL CONDITION. DAMBAR INTRUSION SHALL NOT REDUCE DIMENSION b BY MORE THAN 0.07mm AT LEAST MATERIAL CONDITION.

$\triangle 6$ THESE DIMENSIONS APPLY TO THE FLAT SECTION OF THE LEAD BETWEEN 0.10 & 0.25mm FROM THE LEAD TIP

7. "N" IS THE NUMBER OF TERMINAL POSITIONS

32-Pin QFNS Package Option 1: Power Manager II, iCE40™

Dimensions in Millimeters

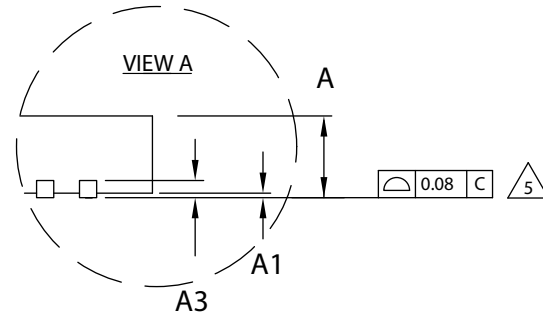
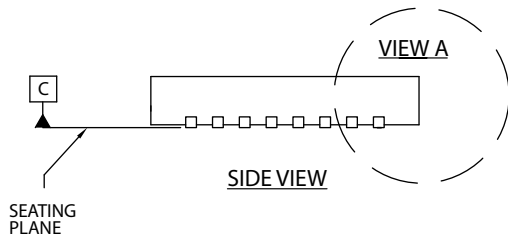
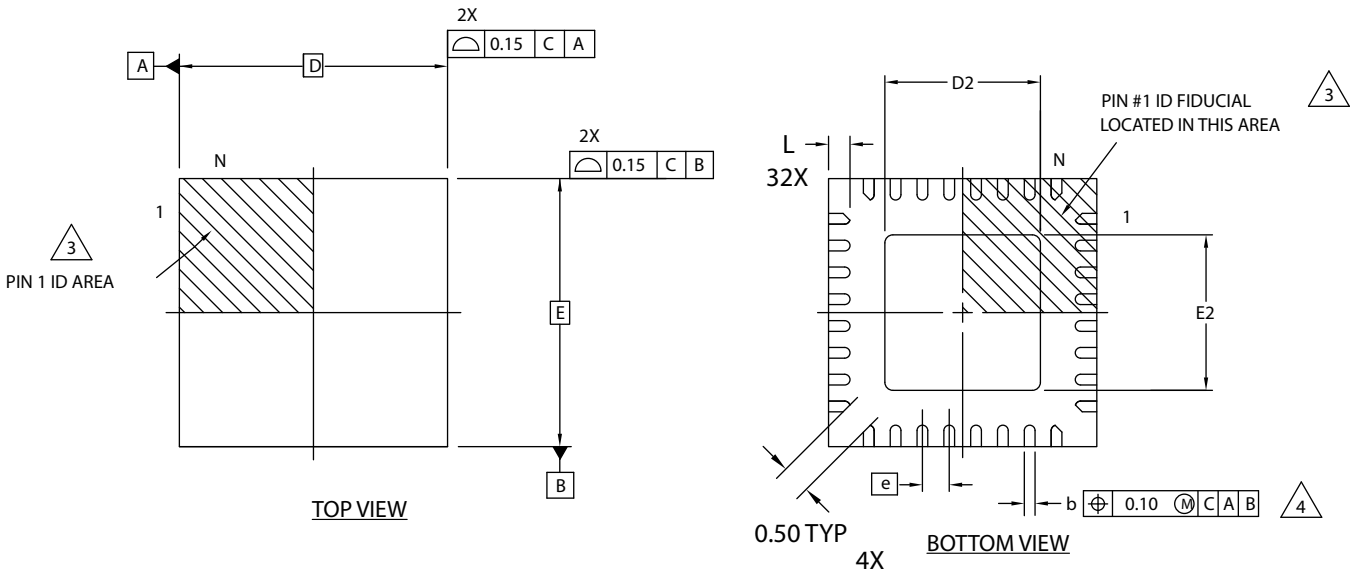

NOTES: UNLESS OTHERWISE SPECIFIED

1. DIMENSIONS AND TOLERANCES PER ANSI Y14.5M.
2. ALL DIMENSIONS ARE IN MILLIMETERS.
3. EXACT SHAPE AND SIZE OF THIS FEATURE IS OPTIONAL.
4. DIMENSION b APPLIES TO PLATED TERMINAL AND IS MEASURED BETWEEN 0.15 AND 0.30 mm FROM TERMINAL TIP.
5. APPLIES TO EXPOSED PORTION OF TERMINALS.

SYMBOL	MIN.	NOM.	MAX.
A	0.80	0.90	1.00
A1	0.00	0.02	0.05
A3	0.2 REF		
D	5.0 BSC		
D2	1.25	2.70	3.75
E	5.0 BSC		
E2	1.25	2.70	3.75
b	0.18	0.24	0.30
e	0.50 BSC		
L	0.30	0.40	0.50

32-Pin QFNS Package Option 2: MachXO2™

Dimensions in Millimeters

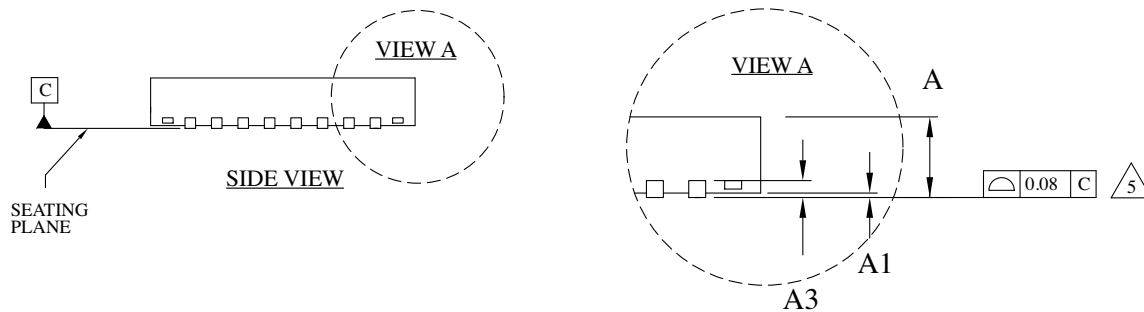
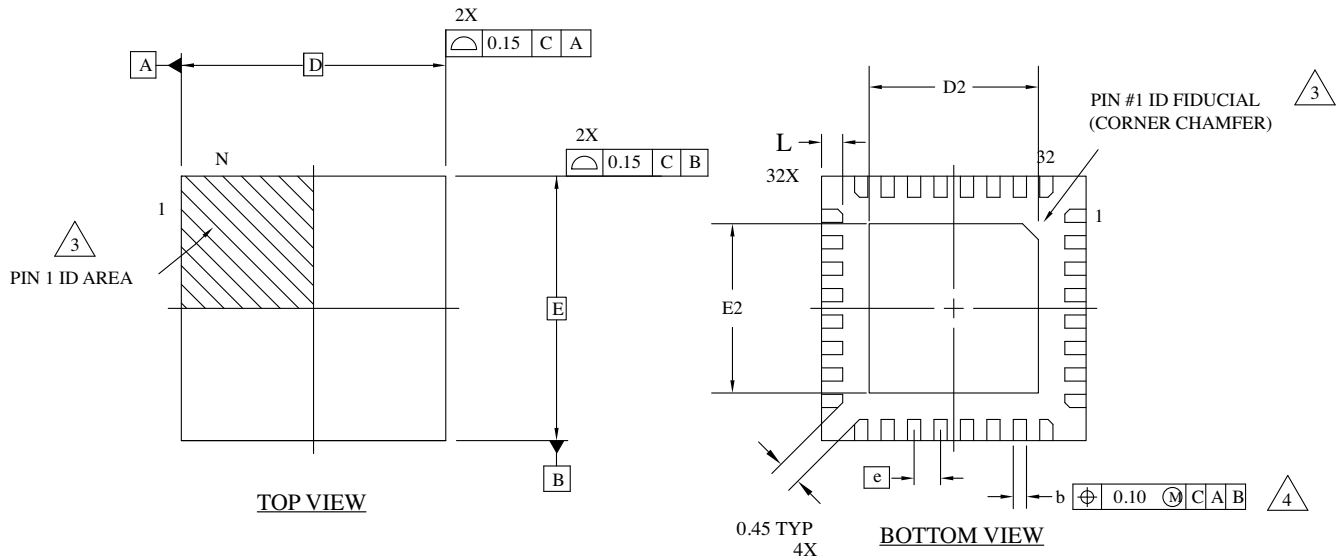

NOTES: UNLESS OTHERWISE SPECIFIED

1. DIMENSIONS AND TOLERANCES PER ANSI Y14.5M.
 2. ALL DIMENSIONS ARE IN MILLIMETERS.
- 3 EXACT SHAPE AND SIZE OF THIS FEATURE IS OPTIONAL.
- 4 DIMENSION b APPLIES TO PLATED TERMINAL AND IS MEASURED BETWEEN 0.15 AND 0.30 mm FROM TERMINAL TIP.
- 5 APPLIES TO EXPOSED PORTION OF TERMINALS.

SYMBOL	MIN.	NOM.	MAX.
A	0.50	0.55	0.60
A1	0.00	0.02	0.05
A3	0.2 REF		
D	5.0 BSC		
D2	3.10	3.20	3.30
E	5.0 BSC		
E2	3.10	3.20	3.30
b	0.20	0.25	0.30
e	0.50 BSC		
L	0.35	0.40	0.45

36-Ball ucBGA Package Option 1

Dimensions in Millimeters

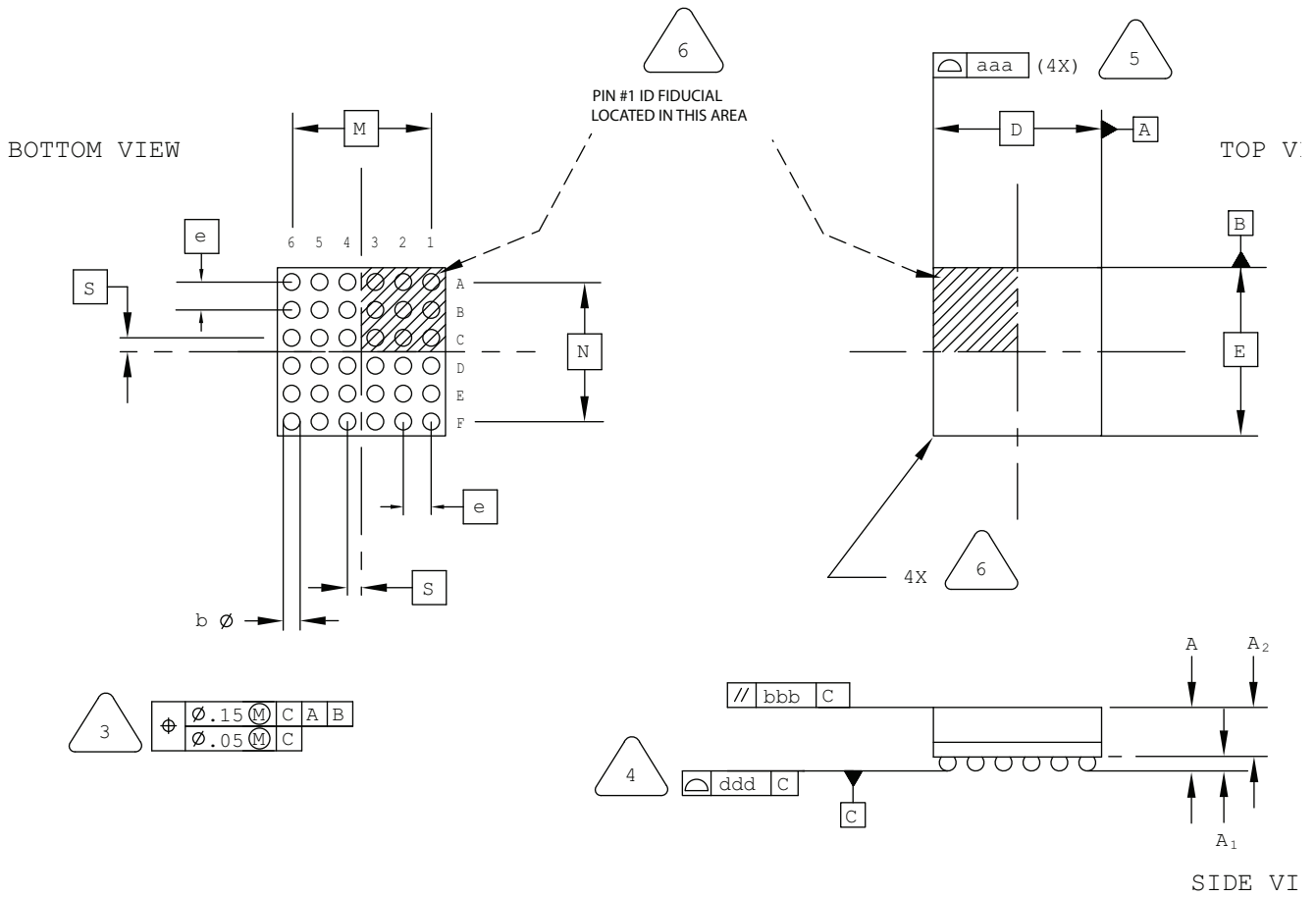

NOTES: UNLESS OTHERWISE SPECIFIED

- DIMENSIONS AND TOLERANCES PER ANSI Y14.5M.
- ALL DIMENSIONS ARE IN MILLIMETERS.



DIMENSION "b" IS MEASURED AT THE MAXIMUM SOLDER BALL DIAMETER, PARALLEL TO PRIMARY DATUM [C]



PRIMARY DATUM [C] AND SEATING PLANE ARE DEFINED BY THE SPHERICAL CROWNS OF THE SOLDER BALLS.



BILATERAL TOLERANCE ZONE IS APPLIED TO EACH SIDE OF THE PACKAGE BODY.



EXACT SHAPE AND SIZE OF THIS FEATURE IS OPTIONAL.

SYMBOL	MIN.	NOM.	MAX.
A	-	-	1.00
A1	0.10	-	-
A2	-	-	0.90
D/E	2.50 BSC		
M/N	2.00 BSC		
S	0.20 BSC		
b	0.20	0.25	0.30
e	0.40 BSC		
aaa	-	-	0.10
bbb	-	-	0.10
ddd	-	-	0.10

36-Ball ucfBGA Package: iCE40 Ultra™

Dimensions in Millimeters

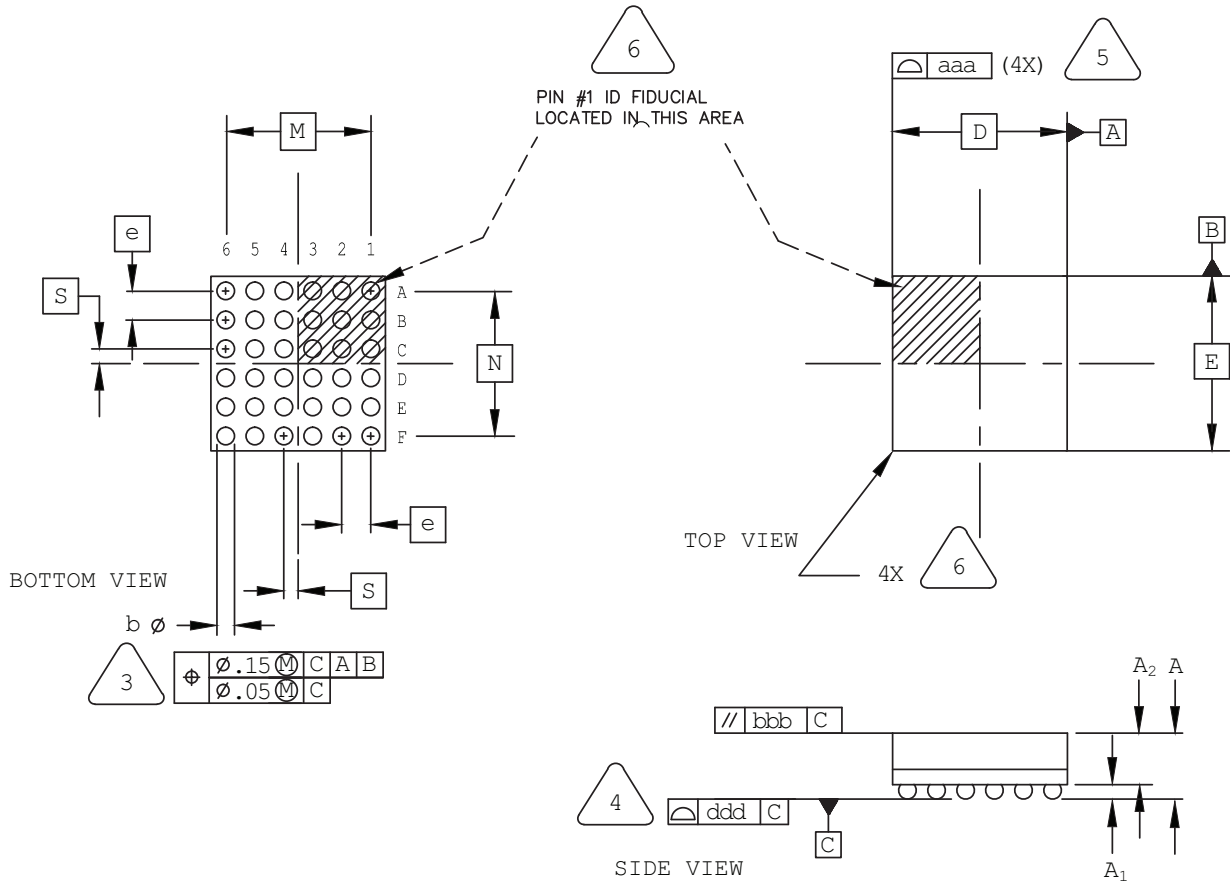

NOTES: UNLESS OTHERWISE SPECIFIED

1. DIMENSIONS AND TOLERANCES PER ANSI Y14.5M.
2. ALL DIMENSIONS ARE IN MILLIMETERS.



DIMENSION "b" IS MEASURED AT THE MAXIMUM SOLDER BALL DIAMETER, PARALLEL TO PRIMARY DATUM [C]



PRIMARY DATUM [C] AND SEATING PLANE ARE DEFINED BY THE SPHERICAL CROWNS OF THE SOLDER BALLS.



BILATERAL TOLERANCE ZONE IS APPLIED TO EACH SIDE OF THE PACKAGE BODY.



EXACT SHAPE AND SIZE OF THIS FEATURE IS OPTIONAL.

SYMBOL	MIN.	NOM.	MAX.
A	-	0.81	0.91
A1	0.12	-	-
A2	-	-	0.70
D/E	2.50 BSC		
M/N	2.00 BSC		
S	0.20 BSC		
b	0.20	0.25	0.30
e	0.40 BSC		
aaa	-	-	0.10
bbb	-	-	0.10
ddd	-	-	0.10

36-Ball WLCS Package Option 1: iCE40 Ultra

Dimensions in Millimeters

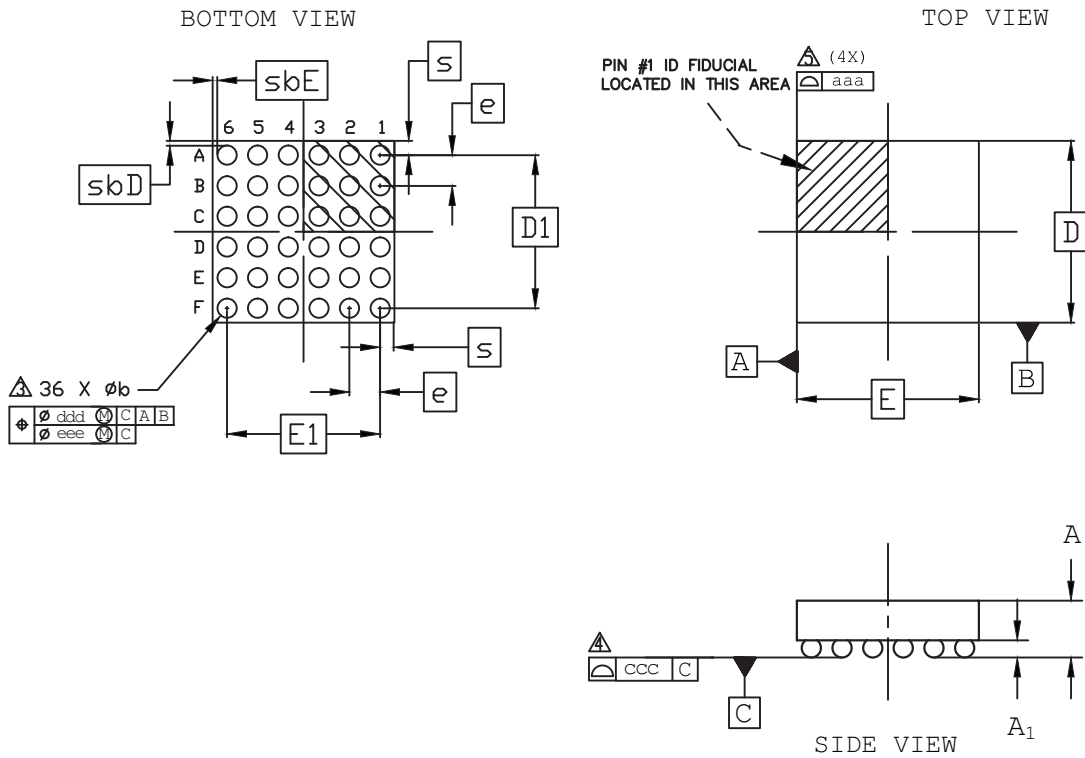

NOTES:

1. ALL DIMENSIONS AND TOLERANCE PER ASME Y 14.5M - 1994.
2. ALL DIMENSIONS ARE IN MILLIMETERS.

▲ DIMENSION "b" IS MEASURES AT THE MAXIMUM BUMP DIAMETER PARALLEL TO PRIMARY DATUM **C**.

▲ PRIMARY DATUM **C** AND SEATING PLANE ARE DEFINED BY THE SPHERICAL CROWNS OF THE SOLDER BUMPS.

▲ BILATERAL TOLERANCE ZONE IS APPLIED TO EACH SIDE OF THE PACKAGE BODY.

REF.	Min.	Nom.	Max.
A	0.413	0.452	0.491
A1	0.122	0.152	0.182
b	0.188	0.218	0.248
D	2.078 BSC		
E	2.078 BSC		
D1	1.75 BSC		
E1	1.75 BSC		
e	0.35 BSC		
s	0.157	0.164	0.172
sbD	0.051	0.055	0.056
sbE	0.051	0.055	0.056
aaa	0.030		
ccc	0.030		
ddd	0.015		
eee	0.050		

36-Ball WLCS Package Option 2: MachXO3™

Dimensions in Millimeters

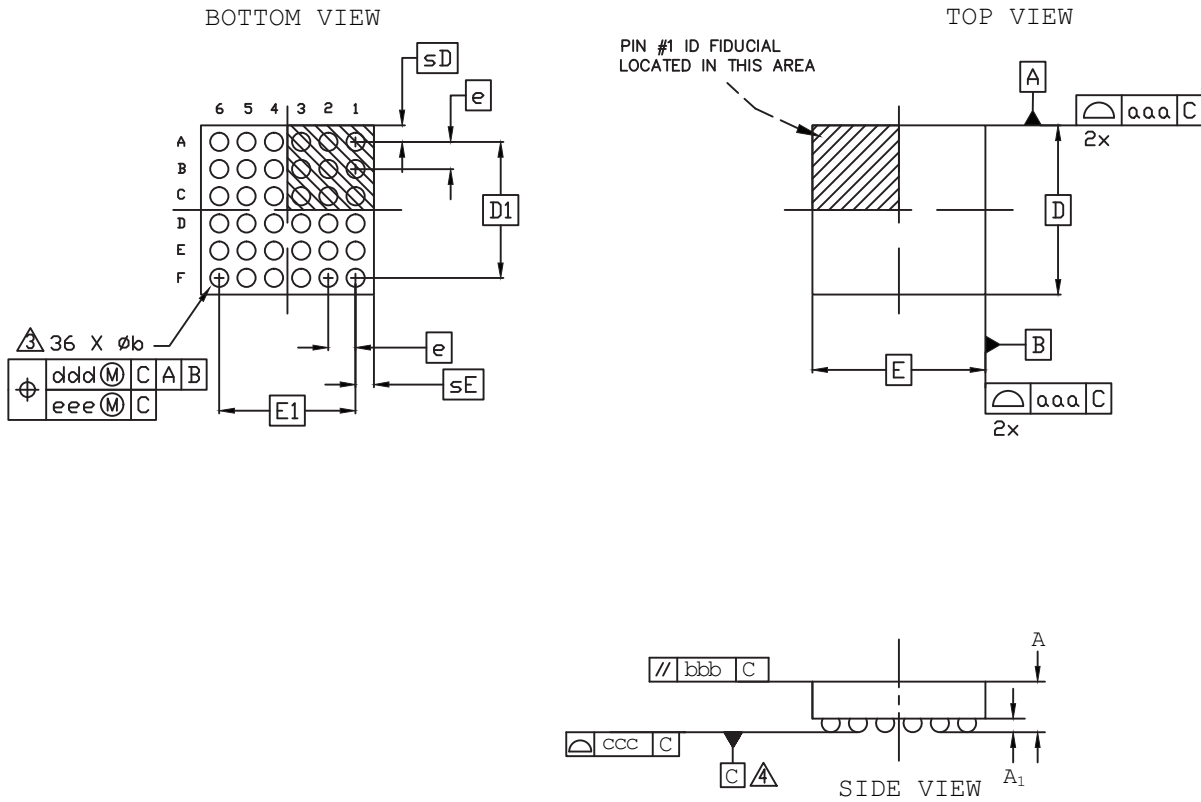

NOTES:

1. ALL DIMENSIONS AND TOLERANCE PER ASME Y 14.5M - 1994.
2. ALL DIMENSIONS ARE IN MILLIMETERS.

▲ DIMENSION "b" IS MEASURES AT THE MAXIMUM BUMP DIAMETER PARALLEL TO PRIMARY DATUM [C].

▲ PRIMARY DATUM [C] AND SEATING PLANE ARE DEFINED BY THE SPHERICAL CROWNS OF THE SOLDER BUMPS.

REF.	Min.	Nom.	Max.
A	0.510	0.543	0.576
A1	0.167	0.196	0.225
b	0.239	0.266	0.319
D	2.487 BSC		
E	2.541 BSC		
D1	2.00 BSC		
E1	2.00 BSC		
e	0.40 BSC		
sD	-	0.244	-
sE	-	0.271	-
aaa	0.025		
bbb	0.060		
ccc	0.030		
ddd	0.0150		
eee	0.050		

44-Pin JLCC Package

Dimensions in Inches

BOTTOM VIEW

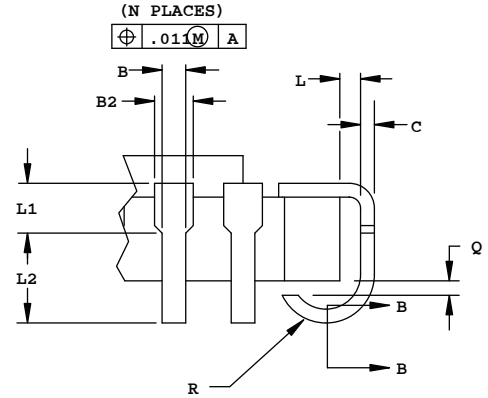
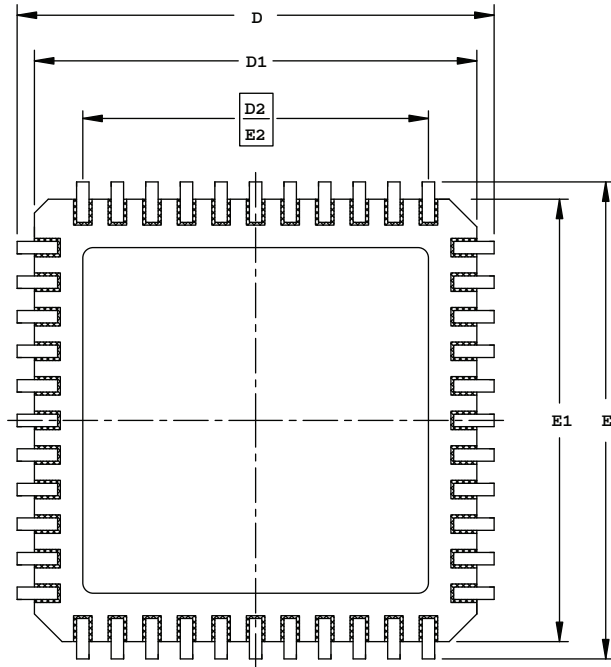

DETAIL A

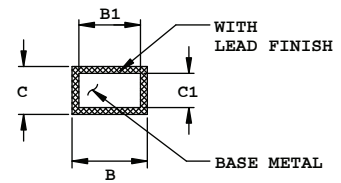

SECTION B-B

SIDE VIEW

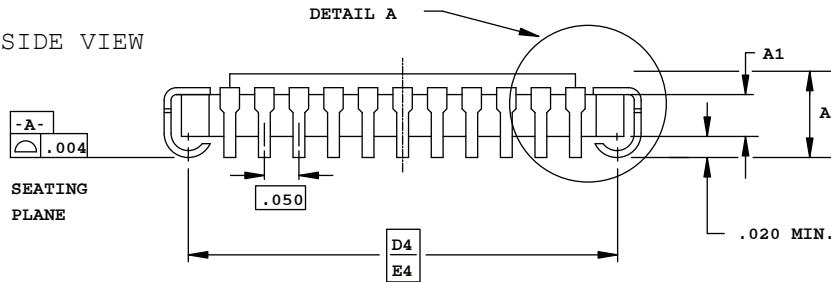

NOTES :

1. DIMENSIONING AND TOLERANCING PER ANSI Y14.5M.
2. ALL DIMENSIONS ARE IN INCHES.
3. CORNER CHAMFERS AND/OR NOTCHES ARE OPTIONAL.

SYMBOL	INCHES		
	MIN.		MAX.
A	.115	-	.190
A1	.065 REF		
B	.013	-	.023
B1	.013	-	.020
B2	.022	-	.035
C	.007	-	.013
C1	.007	-	.010
D/E	.675	.690	.700
D1/E1	.620	-	.660
D2/E2	.500 BSC		
D4/E4	.630 BSC		
L	.005	-	-
L1	.020	-	-
L2	.025	-	-
Q	.003	-	-
R	.020	-	.040
N	44		

44-Pin PLCC Package

Dimensions in Inches

BOTTOM VIEW

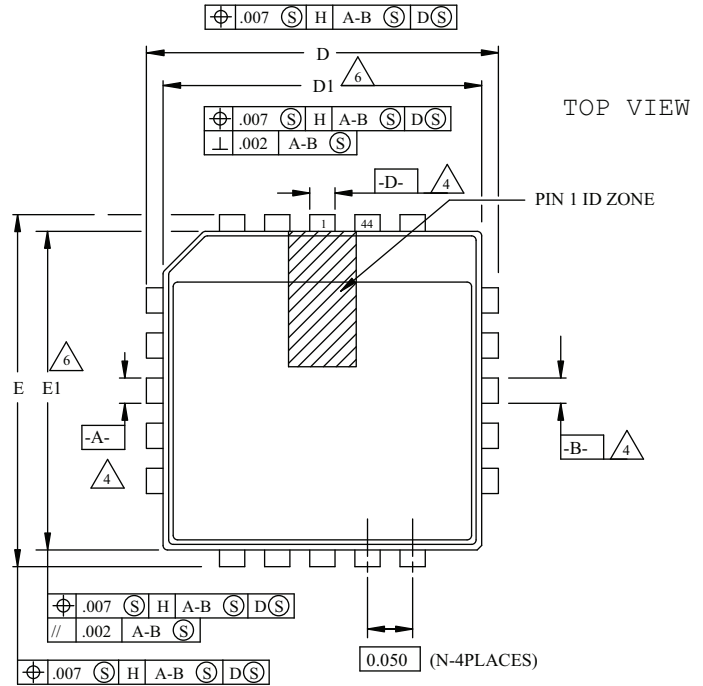
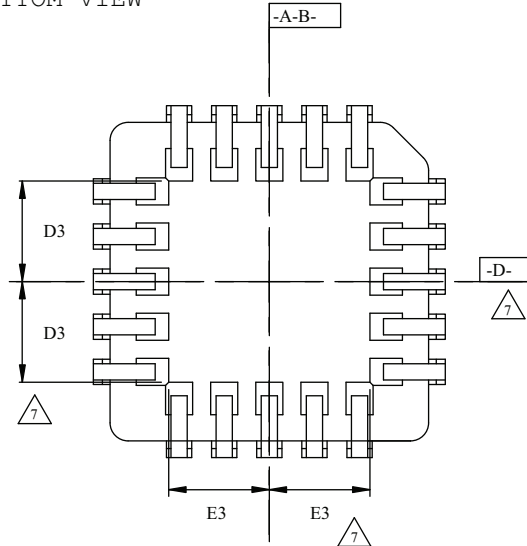

SYMBOL	DIMENSIONS		
	MIN.	NOM.	MAX.
A	.165	.172	.180
A1	.090	.105	.120
A2	.062	-	.083
D	.685	.690	.695
D1	.650	.653	.656
D2	.291	.305	.319
D3		.225	
E	.685	.690	.695
E1	.650	.653	.656
E2	.291	.305	.319
E3		.225	
N		44	

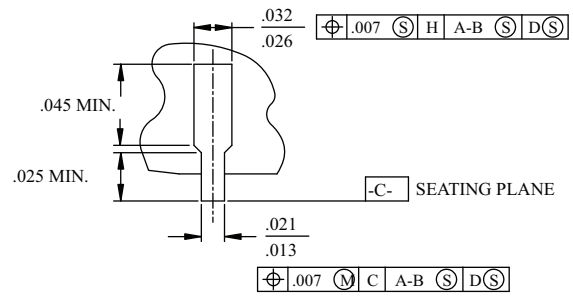
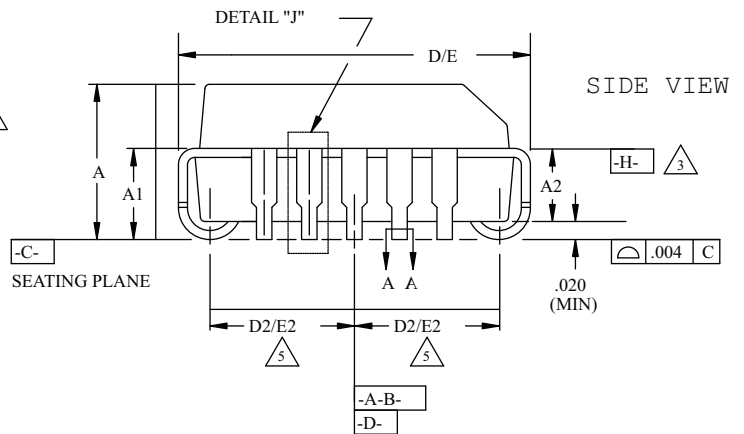
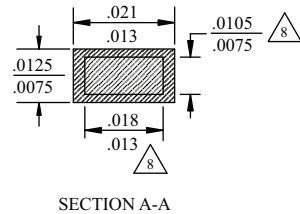

NOTES:

- ALL DIMENSIONS AND TOLERANCES CONFORM TO ANSI Y14.5M-1982
- ALL DIMENSIONS IN INCHES
- DATUM PLANE [-H-] LOCATED AT TOP OF MOLD PARTING LINE AND COINCIDENT WITH TOP OF LEAD WHERE LEAD EXITS PLASTIC BODY
- DATUMS [-A-B-] AND [-D-] TO BE DETERMINED WHERE CENTER LEADS EXIT PLASTIC BODY AT DATUM PLANE [-H-]
- TO BE MEASURED AT SEATING PLANE [-C-] CONTACT POINT
- DIMENSIONS D1 AND E1 DO NOT INCLUDE MOLD PROTRUSION. ALLOWABLE PROTRUSION IS .010 PER SIDE.
- TOP POINT OF MEASUREMENT IS DATUM [-H-]; BOTTOM POINT OF MEASUREMENT IS AT MAJOR FLAT AREA OF LOWER PLASTIC SURFACE DEFINED BY D3/E3
- DIMENSION APPLIES TO BASE METAL ONLY

DETAIL "J" (TYP ALL SIDES)

44-Pin TQFP Package (1.0 mm thick)

Dimensions in Millimeters

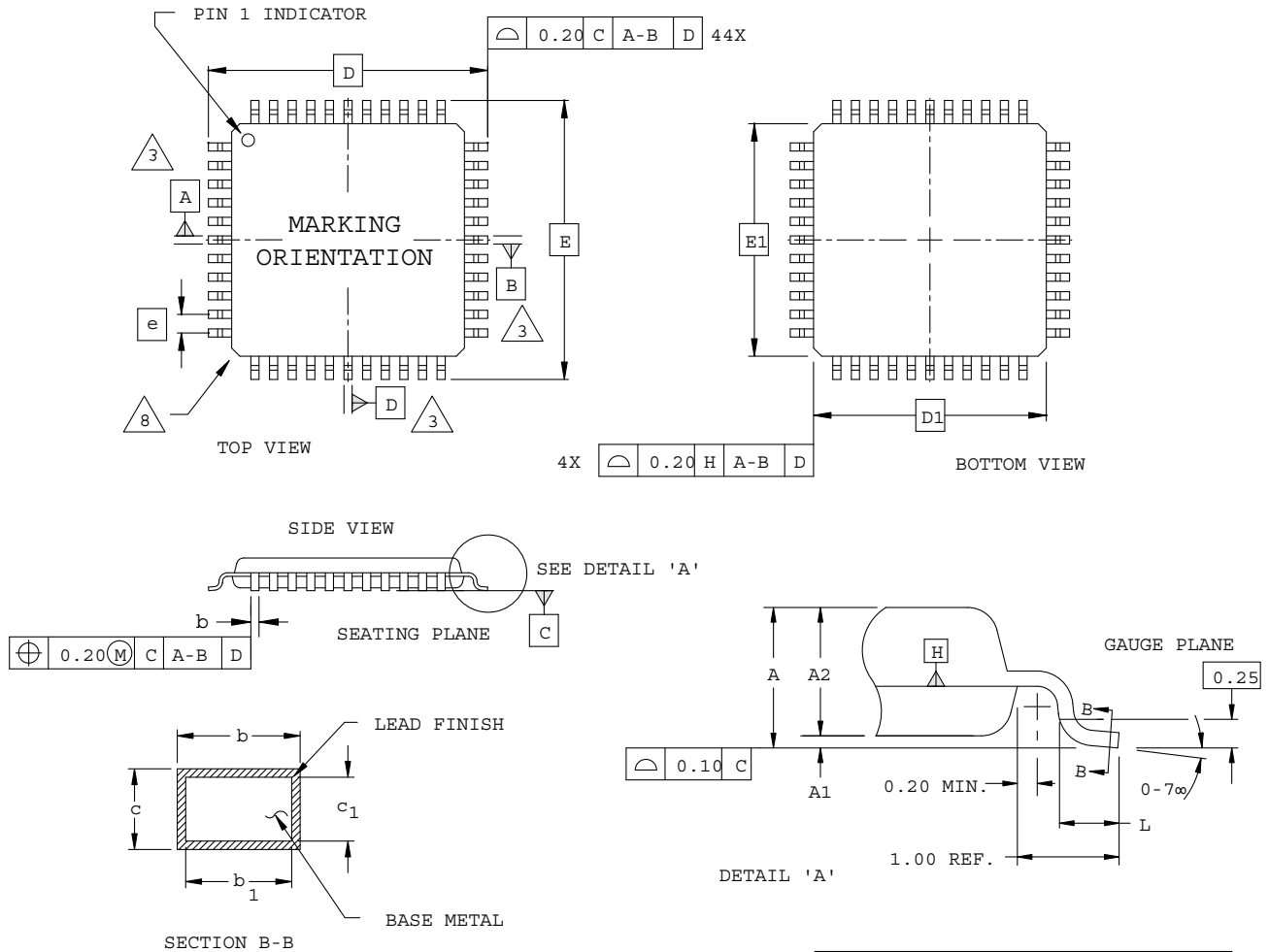

NOTES:

- DIMENSIONING AND TOLERANCING PER ANSI Y14.5 - 1982.
- ALL DIMENSIONS ARE IN MILLIMETERS.
- DATUMS A, B AND D TO BE DETERMINED AT DATUM PLANE H.
- DIMENSIONS D1 AND E1 DO NOT INCLUDE MOLD PROTRUSION. ALLOWABLE MOLD PROTRUSION IS 0.254 MM ON D1 AND E1 DIMENSIONS.
- THE TOP OF PACKAGE MAY BE SMALLER THAN THE BOTTOM OF THE PACKAGE BY 0.15 MM.
- SECTION B-B:
THESE DIMENSIONS APPLY TO THE FLAT SECTION OF THE LEAD BETWEEN 0.10 AND 0.25 MM FROM THE LEAD TIP.
- A1 IS DEFINED AS THE DISTANCE FROM THE SEATING PLANE TO THE LOWEST POINT ON THE PACKAGE BODY.
- EXACT SHAPE OF EACH CORNER IS OPTIONAL.

SYMBOL	MIN.	NOM.	MAX.
A	-	-	1.20
A1	0.05	-	0.15
A2	.95	1.00	1.05
D	12.00 BSC		
D1	10.00 BSC		
E	12.00 BSC		
E1	10.00 BSC		
L	0.45	0.60	0.75
N	44		
e	0.80 BSC		
b	0.30	0.37	0.45
b1	0.30	0.35	0.40
c	0.09	0.15	0.20
c1	0.09	0.13	0.16

44-Pin TQFP Package (1.4 mm thick)

Dimensions in Millimeters

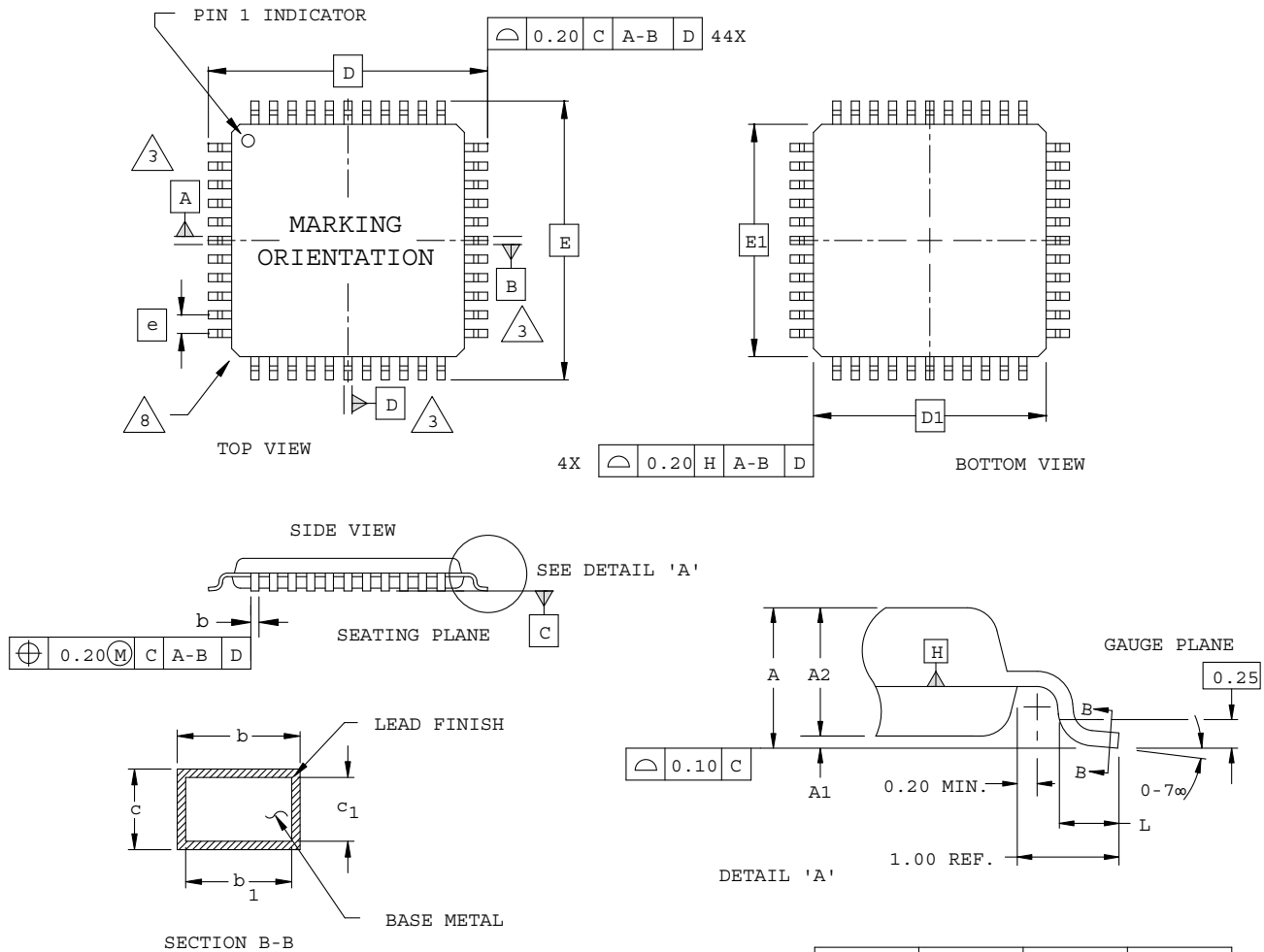

NOTES:

- DIMENSIONING AND TOLERANCING PER ANSI Y14.5 - 1982.
- ALL DIMENSIONS ARE IN MILLIMETERS.
- DATUMS A, B AND D TO BE DETERMINED AT DATUM PLANE H.
- DIMENSIONS D1 AND E1 DO NOT INCLUDE MOLD PROTRUSION. ALLOWABLE MOLD PROTRUSION IS 0.254 MM ON D1 AND E1 DIMENSIONS.
- THE TOP OF PACKAGE MAY BE SMALLER THAN THE BOTTOM OF THE PACKAGE BY 0.15 MM.
- SECTION B-B:
THESE DIMENSIONS APPLY TO THE FLAT SECTION OF THE LEAD BETWEEN 0.10 AND 0.25 MM FROM THE LEAD TIP.
- A1 IS DEFINED AS THE DISTANCE FROM THE SEATING PLANE TO THE LOWEST POINT ON THE PACKAGE BODY.
- EXACT SHAPE OF EACH CORNER IS OPTIONAL.

SYMBOL	MIN.	NOM.	MAX.
A	-	-	1.60
A1	0.05	-	0.15
A2	1.35	1.40	1.45
D	12.00 BSC		
D1	10.00 BSC		
E	12.00 BSC		
E1	10.00 BSC		
L	0.45	0.60	0.75
N	44		
e	0.80 BSC		
b	0.30	0.37	0.45
b1	0.30	0.35	0.40
c	0.09	0.15	0.20
c1	0.09	0.13	0.16

48-Pin TQFP Package (1.0 mm thick)

Dimensions in Millimeters

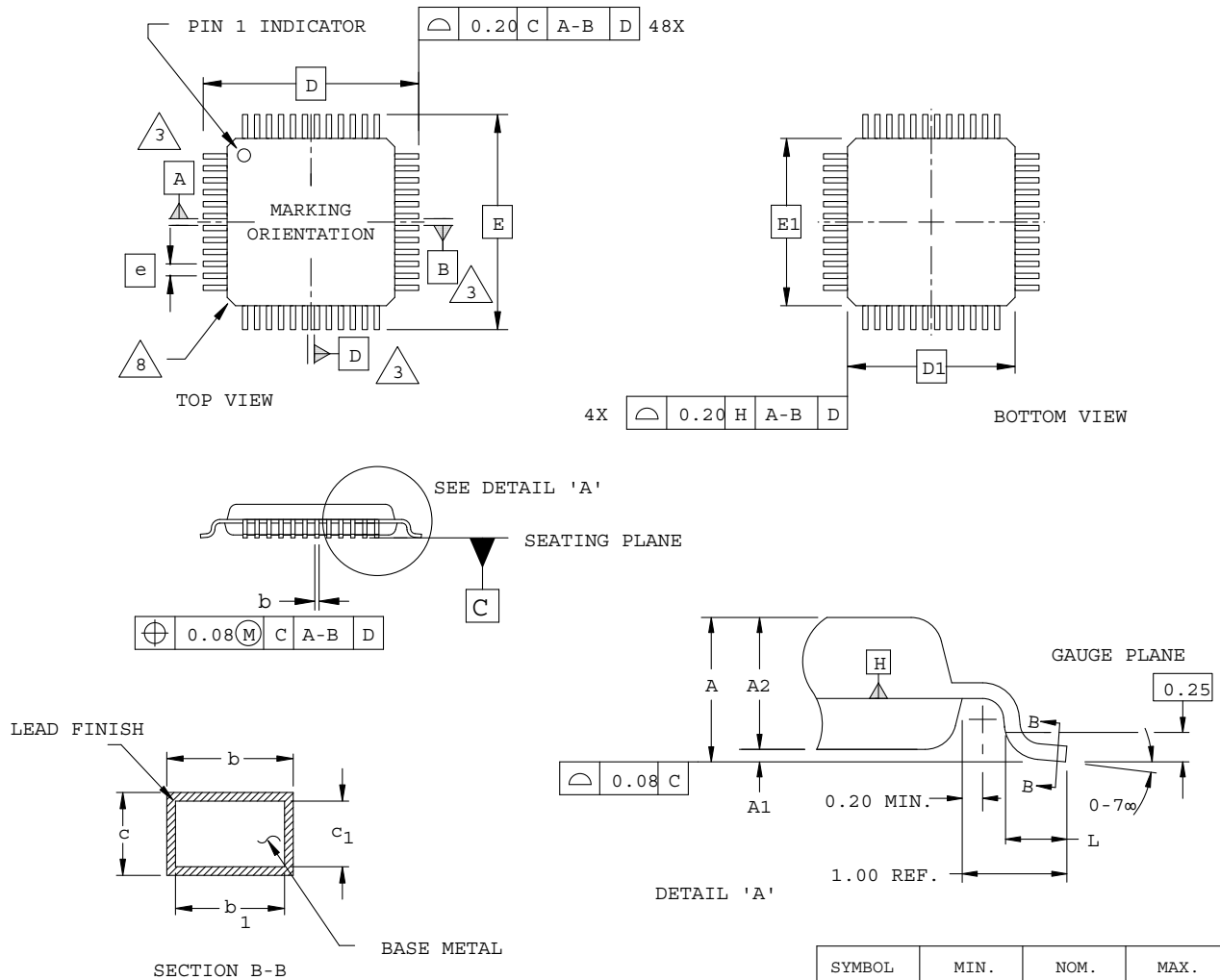

NOTES:

- DIMENSIONING AND TOLERANCING PER ANSI Y14.5 - 1982.
- ALL DIMENSIONS ARE IN MILLIMETERS.
- DATUMS A, B AND D TO BE DETERMINED AT DATUM PLANE H.
- DIMENSIONS D1 AND E1 DO NOT INCLUDE MOLD PROTRUSION. ALLOWABLE MOLD PROTRUSION IS 0.254 MM ON D1 AND E1 DIMENSIONS.
- THE TOP OF PACKAGE MAY BE SMALLER THAN THE BOTTOM OF THE PACKAGE BY 0.15 MM.
- SECTION B-B:
THESE DIMENSIONS APPLY TO THE FLAT SECTION OF THE LEAD BETWEEN 0.10 AND 0.25 MM FROM THE LEAD TIP.
- A1 IS DEFINED AS THE DISTANCE FROM THE SEATING PLANE TO THE LOWEST POINT ON THE PACKAGE BODY.
- EXACT SHAPE OF EACH CORNER IS OPTIONAL.

SYMBOL	MIN.	NOM.	MAX.
A	-	-	1.20
A1	0.05	-	0.15
A2	.95	1.00	1.05
D	9.00 BSC		
D1	7.00 BSC		
E	9.00 BSC		
E1	7.00 BSC		
L	0.45	0.60	0.75
N	48		
e	0.50 BSC		
b	0.17	0.22	0.27
b1	0.17	0.20	0.23
c	0.09	0.15	0.20
c1	0.09	0.13	0.16

48-Pin TQFP Package (1.4 mm thick)

Dimensions in Millimeters

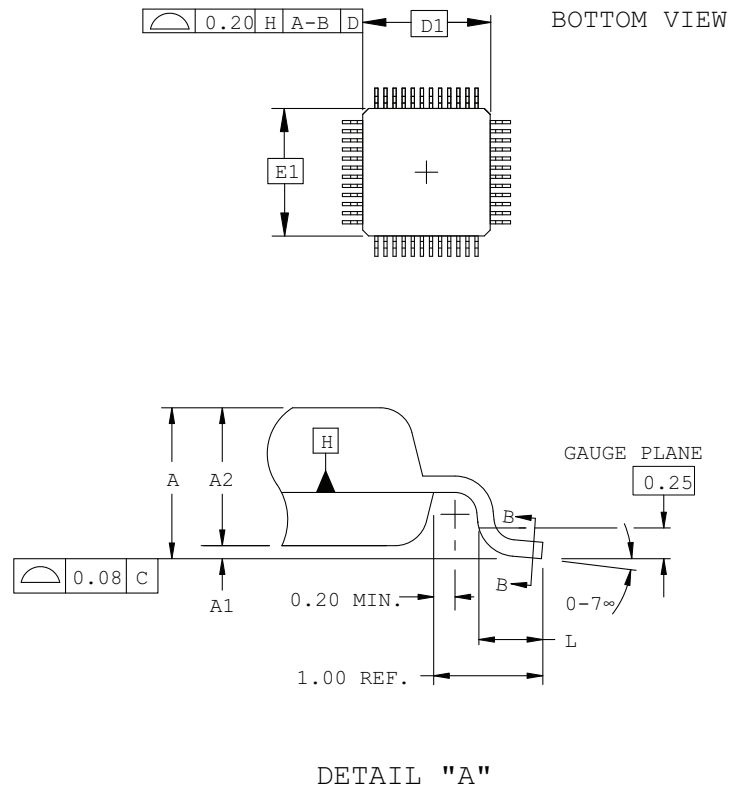
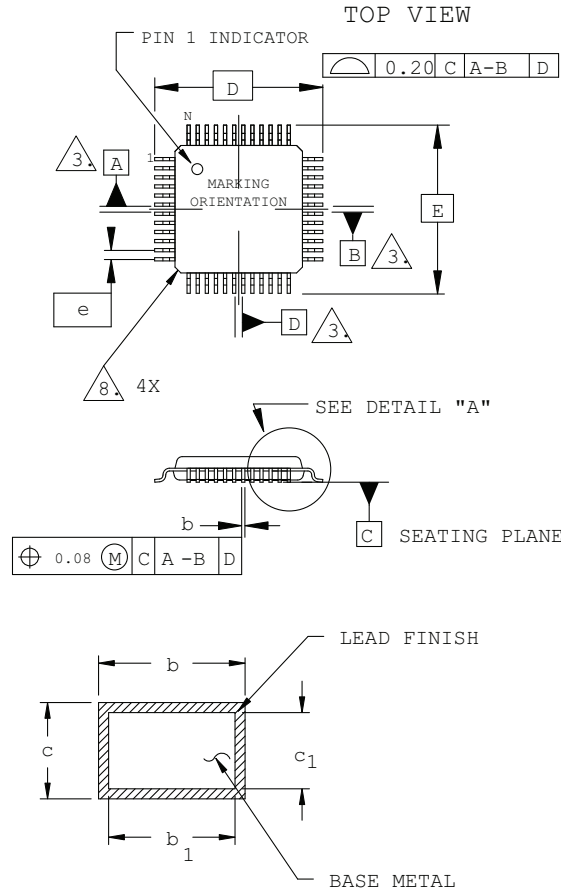

SECTION B - B

NOTES:

1. DIMENSIONING AND TOLERANCING PER ANSI Y14.5 - 1982.
2. ALL DIMENSIONS ARE IN MILLIMETERS.
3. DATUMS A, B AND D TO BE DETERMINED AT DATUM PLANE H.
4. DIMENSIONS D1 AND E1 DO NOT INCLUDE MOLD PROTRUSION. ALLOWABLE MOLD PROTRUSION IS 0.254 MM ON D1 AND E1 DIMENSIONS.
5. THE TOP OF PACKAGE MAY BE SMALLER THAN THE BOTTOM OF THE PACKAGE BY 0.15 MM.
6. SECTION B-B:
THESE DIMENSIONS APPLY TO THE FLAT SECTION OF THE LEAD BETWEEN 0.10 AND 0.25 MM FROM THE LEAD TIP.
7. A1 IS DEFINED AS THE DISTANCE FROM THE SEATING PLANE TO THE LOWEST POINT ON THE PACKAGE BODY.
8. EXACT SHAPE OF EACH CORNER IS OPTIONAL.

SYMBOL	MIN.	NOM.	MAX.
A	-	-	1.60
A1	0.05	-	0.15
A2	1.35	1.40	1.45
D	9.00 BSC		
D1	7.00 BSC		
E	9.00 BSC		
E1	7.00 BSC		
L	0.45	0.60	0.75
N	48		
e	0.50 BSC		
b	0.17	0.22	0.27
b1	0.17	0.20	0.23
c	0.09	0.15	0.20
c1	0.09	0.13	0.16

48-Pin QFN Package Option 1

Dimensions in Millimeters

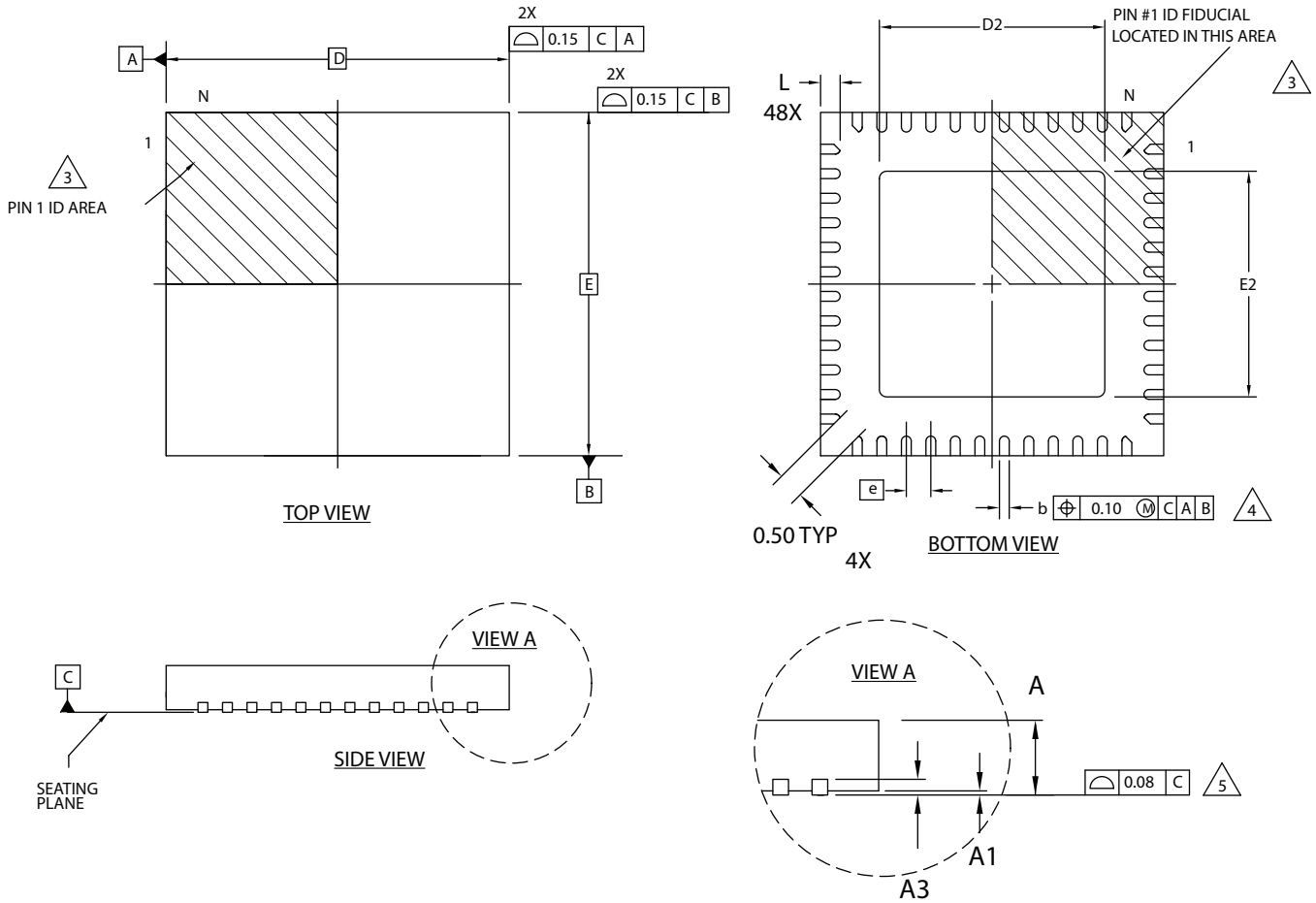

NOTES: UNLESS OTHERWISE SPECIFIED

1. DIMENSIONS AND TOLERANCES PER ANSI Y14.5M.
 2. ALL DIMENSIONS ARE IN MILLIMETERS.
- △3 EXACT SHAPE AND SIZE OF THIS FEATURE IS OPTIONAL.
- △4 DIMENSION b APPLIES TO PLATED TERMINAL AND IS MEASURED BETWEEN 0.15 AND 0.30 mm FROM TERMINAL TIP.
- △5 APPLIES TO EXPOSED PORTION OF TERMINALS.

SYMBOL	MIN.	NOM.	MAX.
A	0.80	0.90	1.00
A1	0.00	0.02	0.05
A3	0.2 REF		
D	7.0 BSC		
D2	3.00	-	5.80
E	7.0 BSC		
E2	3.00	-	5.80
b	0.18	0.24	0.30
e	0.50 BSC		
L	0.30	0.40	0.50

48-Pin QFN Package Option 2: L-ASC10, iCE40 Ultra

Dimensions in Millimeters

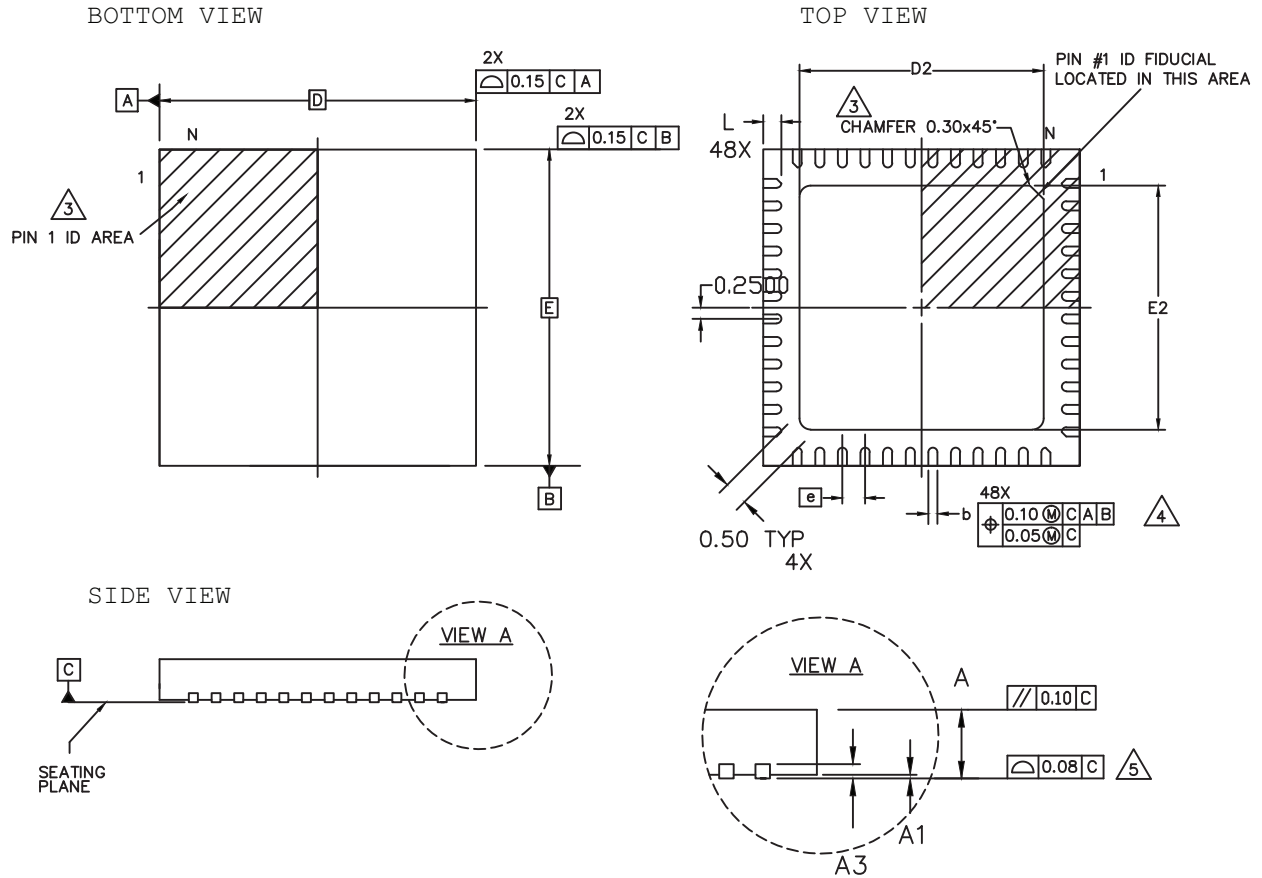

NOTES: UNLESS OTHERWISE SPECIFIED

1. DIMENSIONS AND TOLERANCES PER ANSI Y14.5M.
2. ALL DIMENSIONS ARE IN MILLIMETERS.

EXACT SHAPE AND SIZE OF THIS FEATURE IS OPTIONAL.

DIMENSION b APPLIES TO PLATED TERMINAL AND IS MEASURED BETWEEN 0.15 AND 0.30 mm FROM TERMINAL TIP.

APPLIES TO EXPOSED PORTION OF TERMINALS.

SYMBOL	MIN.	NOM.	MAX.
A	0.80	0.90	1.00
A1	0.00	0.02	0.05
A3	0.2 REF		
D	7.0 BSC		
D2	5.30	5.40	5.50
E	7.0 BSC		
E2	5.30	5.40	5.50
b	0.15	0.20	0.25
e	0.50 BSC		
L	0.35	0.40	0.45

49-Ball caBGA Package

Dimensions in Millimeters

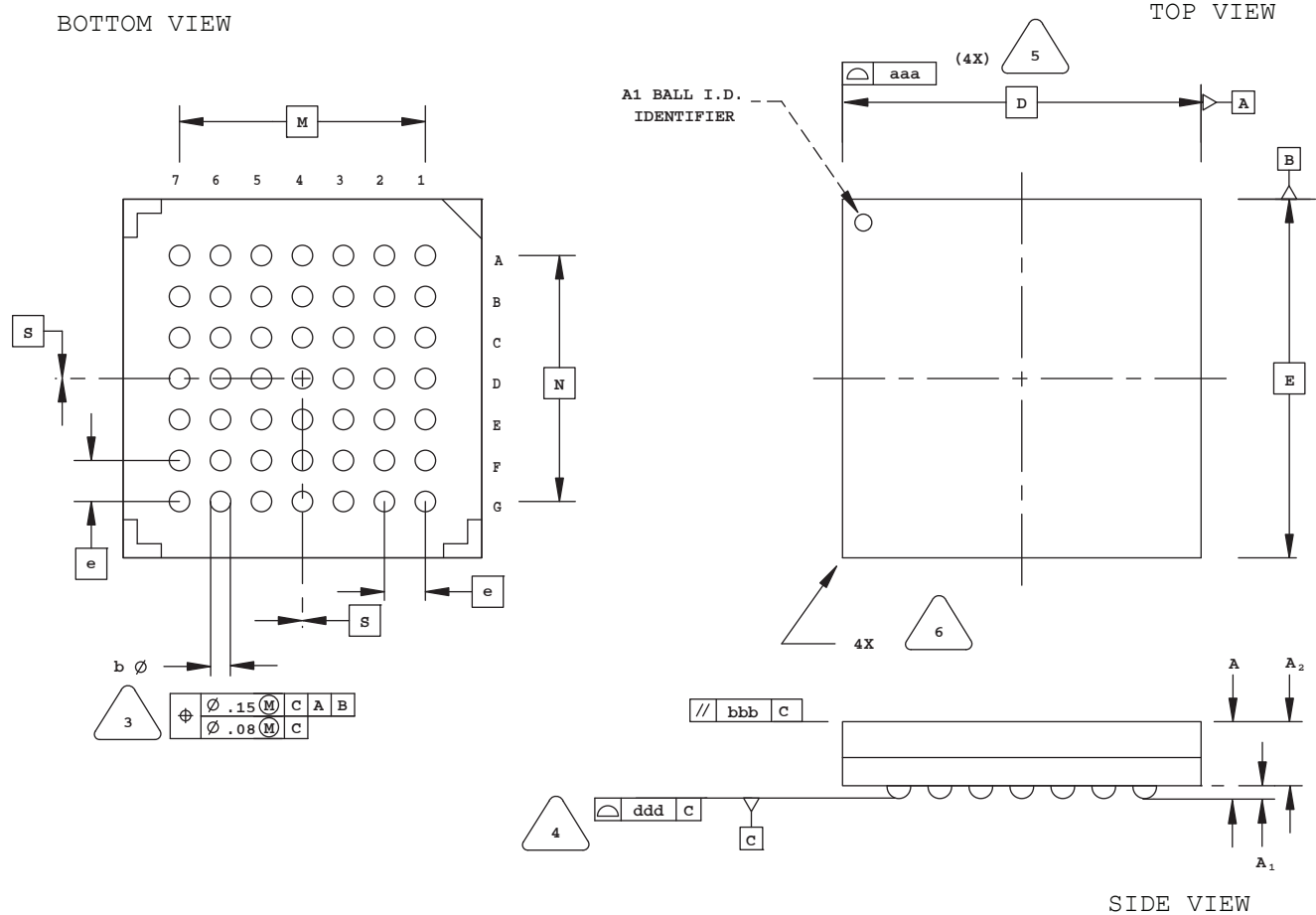

NOTES: UNLESS OTHERWISE SPECIFIED

1. DIMENSIONS AND TOLERANCES PER ANSI Y14.5M.
2. ALL DIMENSIONS ARE IN MILLIMETERS.



DIMENSION "b" IS MEASURED AT THE MAXIMUM SOLDER BALL DIAMETER, PARALLEL TO PRIMARY DATUM C



PRIMARY DATUM C AND SEATING PLANE ARE DEFINED BY THE SPHERICAL CROWNS OF THE SOLDER BALLS.



BILATERAL TOLERANCE ZONE IS APPLIED TO EACH SIDE OF THE PACKAGE BODY.



EXACT SHAPE AND SIZE OF THIS FEATURE IS OPTIONAL.

SYMBOL	MIN.	NOM.	MAX.
A	1.30	1.40	1.50
A1	0.31	0.36	0.41
A2	0.99	1.04	1.09
D/E	7.00 BSC		
M/N	4.80 BSC		
S	0 BSC		
b	0.40	0.46	0.52
e	0.80 BSC		
aaa	-	-	0.10
bbb	-	-	0.10
ddd	-	-	0.12

49-Ball ucBGA Package

Dimensions in Millimeters

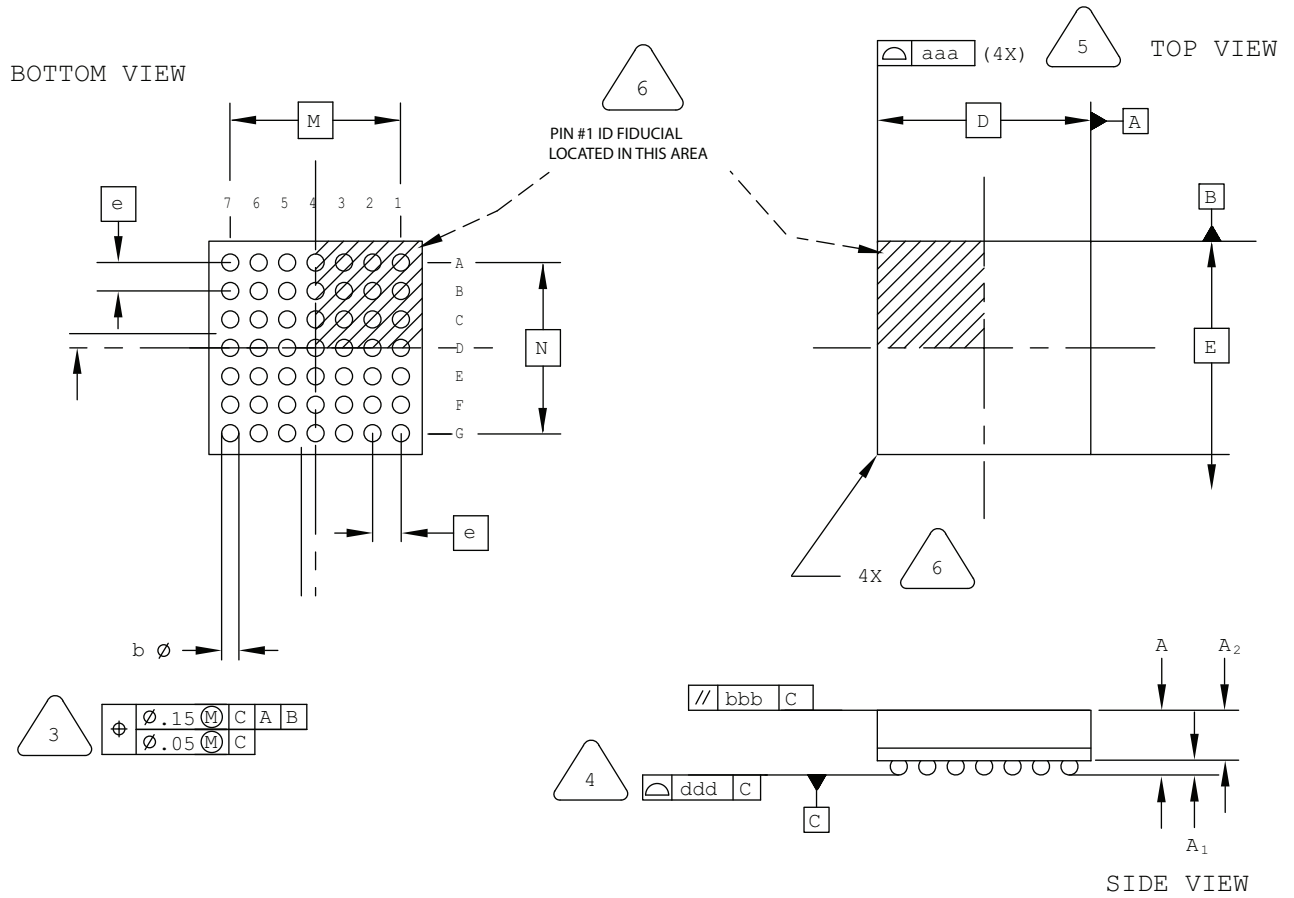

NOTES: UNLESS OTHERWISE SPECIFIED

1. DIMENSIONS AND TOLERANCES PER ANSI Y14.5M.
2. ALL DIMENSIONS ARE IN MILLIMETERS.



DIMENSION "b" IS MEASURED AT THE MAXIMUM SOLDER BALL DIAMETER, PARALLEL TO PRIMARY DATUM [C]



PRIMARY DATUM [C] AND SEATING PLANE ARE DEFINED BY THE SPHERICAL CROWNS OF THE SOLDER BALLS.



BILATERAL TOLERANCE ZONE IS APPLIED TO EACH SIDE OF THE PACKAGE BODY.



EXACT SHAPE AND SIZE OF THIS FEATURE IS OPTIONAL.

SYMBOL	MIN.	NOM.	MAX.
A	-	-	1.00
A1	0.10	-	-
A2	-	-	0.90
D/E	3.00 BSC		
M/N	2.40 BSC		
b	0.20	0.25	0.30
e	0.40 BSC		
aaa	-	-	0.10
bbb	-	-	0.10
ddd	-	-	0.10

49-Ball WLCS Package

Dimensions in Millimeters

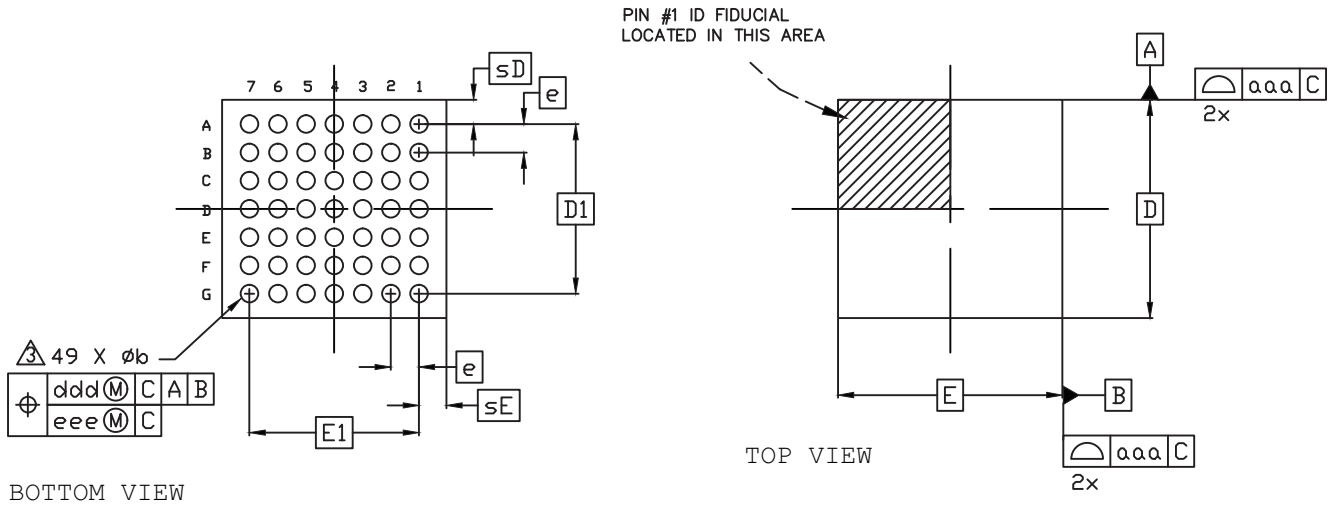

BOTTOM VIEW

TOP VIEW

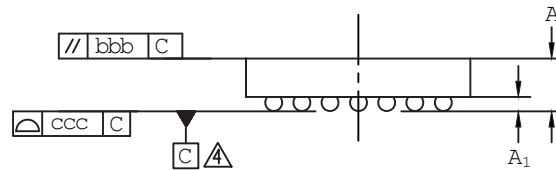

SIDE VIEW

Notes:

- 1 ALL DIMENSIONS AND TOLERANCE PER ASME Y 14.5M - 1994.
- 2 ALL DIMENSIONS ARE IN MILLIMETERS.
- △ DIMENSION "b" IS MEASURED AT THE MAXIMUM BUMP DIAMETER PARALLEL TO PRIMARY DATUM C.
- △ PRIMARY DATUM C AND SEATING PLANE ARE DEFINED BY THE SPHERICAL CROWNS OF THE SOLDER BUMPS.

REF.	Min.	Nom.	Max.
A	-	-	0.600
A1	0.167	0.199	0.232
b	0.239	0.266	0.319
D	3.055	3.106	3.155
E	3.125	3.185	3.225
D1	2.40 BSC		
E1	2.40 BSC		
e	0.40 BSC		
sD	0.353	-	0.383
sE	0.388	-	0.418
aaa	0.030		
bbb	0.060		
ccc	0.050		
ddd	0.015		
eee	0.050		

56-Ball csBGA Package

Dimensions in Millimeters

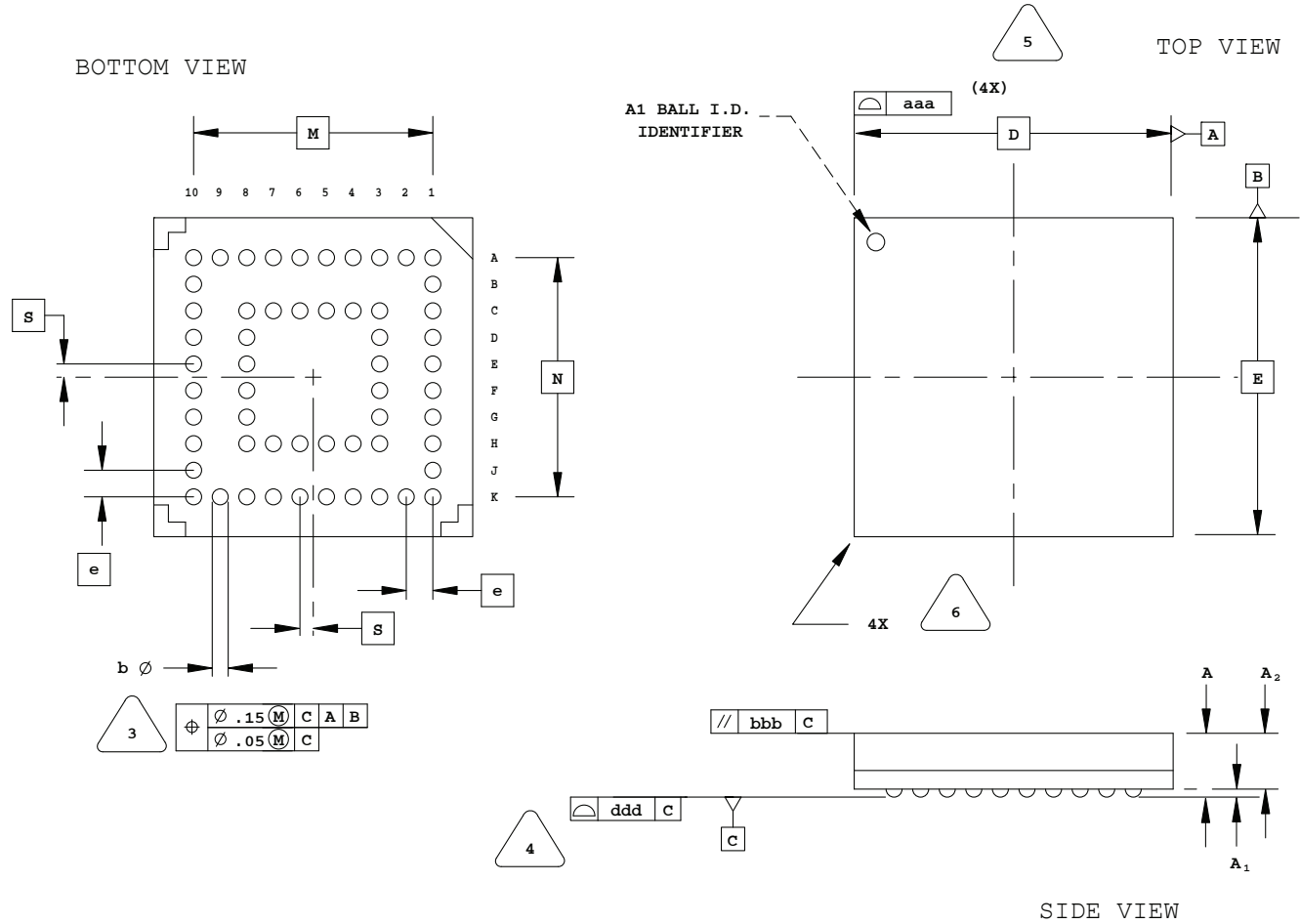

NOTES: UNLESS OTHERWISE SPECIFIED

- DIMENSIONS AND TOLERANCES PER ANSI Y14.5M.
- ALL DIMENSIONS ARE IN MILLIMETERS.

- 3 DIMENSION "b" IS MEASURED AT THE MAXIMUM SOLDER BALL DIAMETER, PARALLEL TO PRIMARY DATUM **C**
- 4 PRIMARY DATUM **C** AND SEATING PLANE ARE DEFINED BY THE SPHERICAL CROWNS OF THE SOLDER BALLS.
- 5 BILATERAL TOLERANCE ZONE IS APPLIED TO EACH SIDE OF THE PACKAGE BODY.
- 6 EXACT SHAPE AND SIZE OF THIS FEATURE IS OPTIONAL.

SYMBOL	MIN.	NOM.	MAX.
A	1.10	1.23	1.35
A1	0.15	-	-
A2	-	-	1.10
D/E	6.00 BSC		
M/N	4.50 BSC		
S	0.25 BSC		
b	0.25	0.30	0.35
e	0.50 BSC		
aaa	-	-	0.10
bbb	-	-	0.10
ddd	-	-	0.08

64-Ball csBGA Package

Dimensions in Millimeters

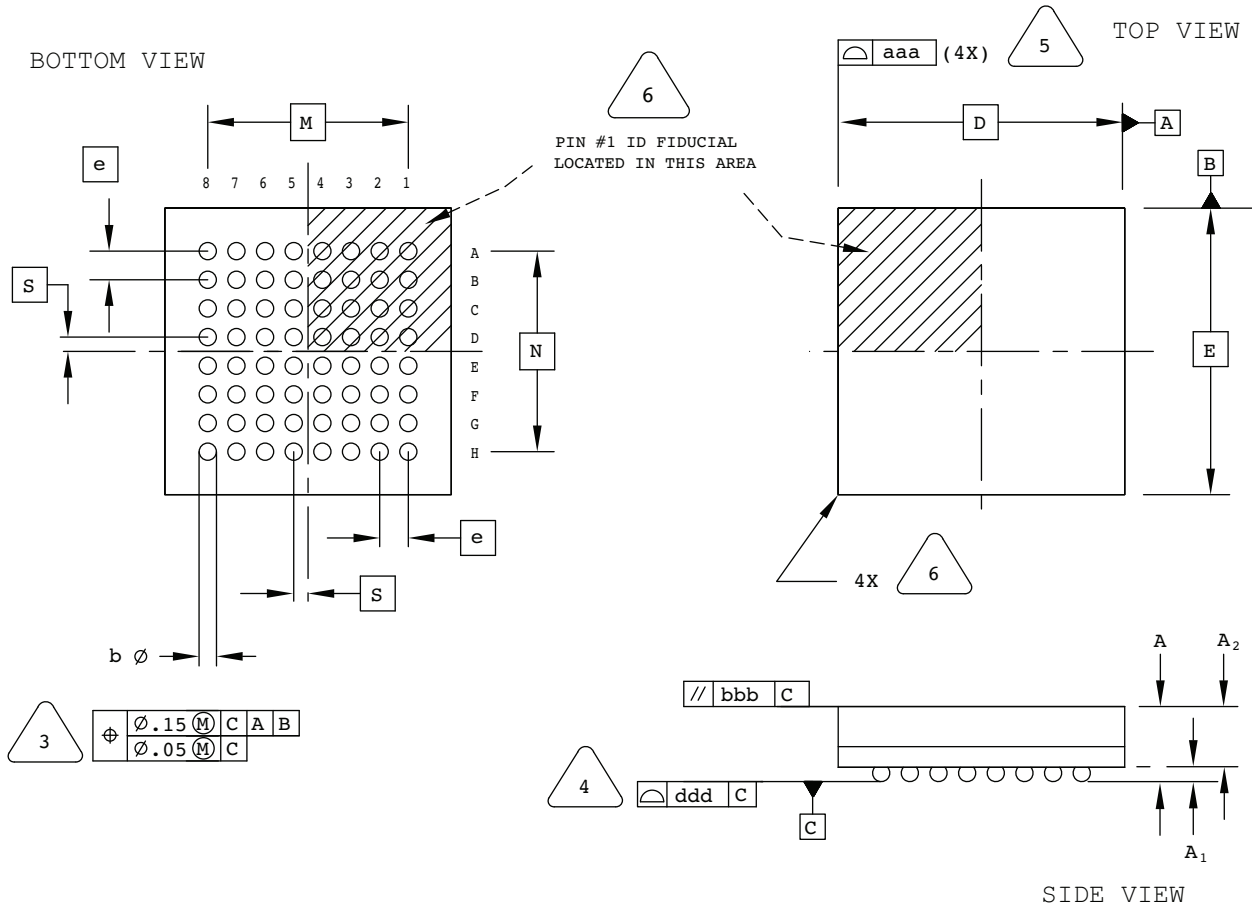

NOTES: UNLESS OTHERWISE SPECIFIED

- DIMENSIONS AND TOLERANCES PER ANSI Y14.5M.
- ALL DIMENSIONS ARE IN MILLIMETERS.



DIMENSION "b" IS MEASURED AT THE MAXIMUM SOLDER BALL DIAMETER, PARALLEL TO PRIMARY DATUM [C]



PRIMARY DATUM [C] AND SEATING PLANE ARE DEFINED BY THE SPHERICAL CROWNS OF THE SOLDER BALLS.



BILATERAL TOLERANCE ZONE IS APPLIED TO EACH SIDE OF THE PACKAGE BODY.



EXACT SHAPE AND SIZE OF THIS FEATURE IS OPTIONAL.

SYMBOL	MIN.	NOM.	MAX.
A	0.90	1.00	1.10
A1	0.15	-	-
A2	-	-	0.85
D/E	5.00 BSC		
M/N	3.50 BSC		
S	0.25 BSC		
b	0.25	0.30	0.35
e	0.50 BSC		
aaa	-	-	0.10
bbb	-	-	0.10
ddd	-	-	0.08

64-Pin QFNS Package

Dimensions in Millimeters

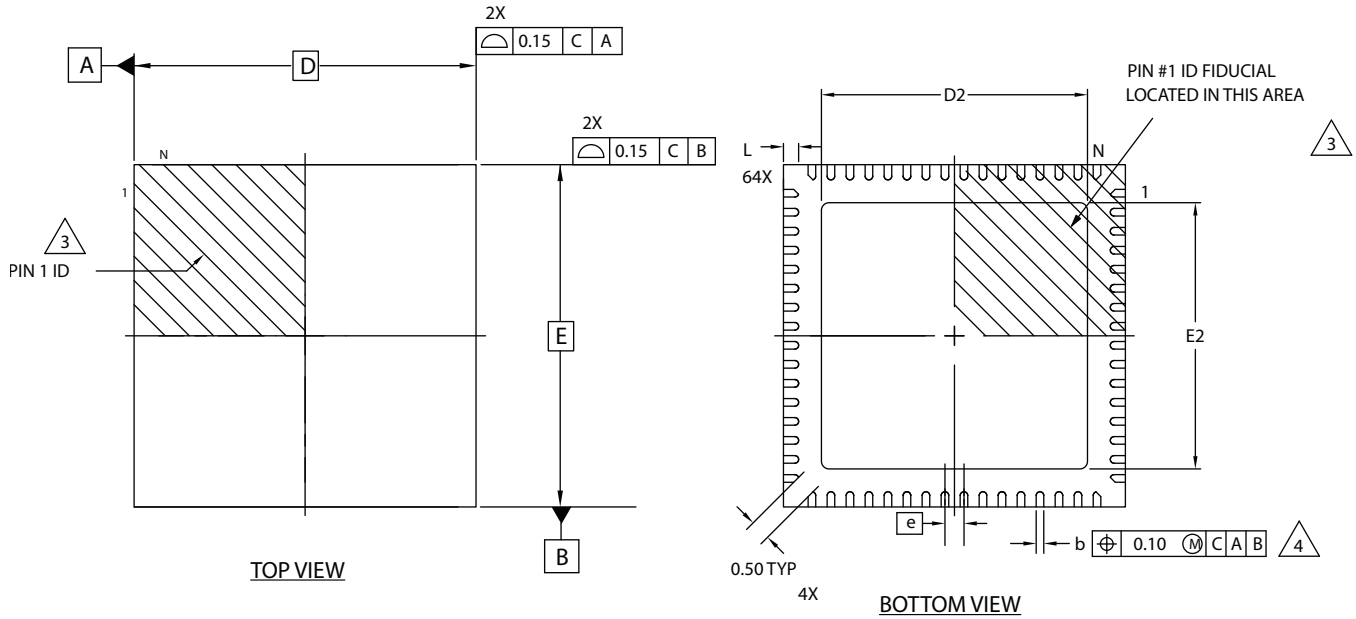

NOTES: UNLESS OTHERWISE SPECIFIED

- DIMENSIONS AND TOLERANCES PER ANSI Y14.5M.
- ALL DIMENSIONS ARE IN MILLIMETERS.

△3 EXACT SHAPE AND SIZE OF THIS FEATURE IS OPTIONAL.

△4 DIMENSION b APPLIES TO PLATED TERMINAL AND IS MEASURED BETWEEN 0.15 AND 0.30 mm FROM TERMINAL TIP.

△5 APPLIES TO EXPOSED PORTION OF TERMINALS.

SYMBOL	MIN.	NOM.	MAX.
A	0.80	0.90	1.00
A1	0.00	0.02	0.05
A3	0.2 REF		
D	9.0 BSC		
D2	5.00	-	7.50
E	9.0 BSC		
E2	5.00	-	7.50
b	0.18	0.24	0.30
e	0.50 BSC		
L	0.30	0.40	0.50

64-Ball ucBGA Package

Dimensions in Millimeters

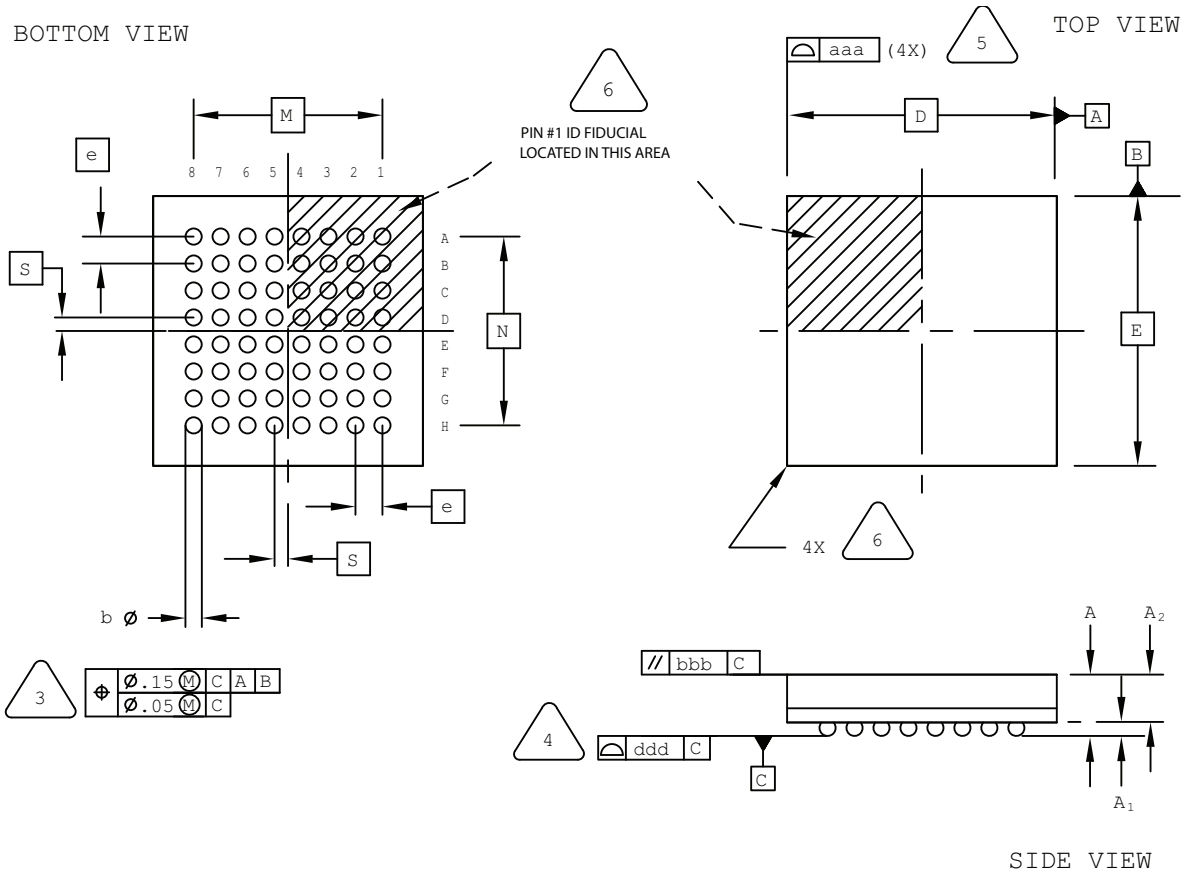

NOTES: UNLESS OTHERWISE SPECIFIED

1. DIMENSIONS AND TOLERANCES PER ANSI Y14.5M.
2. ALL DIMENSIONS ARE IN MILLIMETERS.



DIMENSION "b" IS MEASURED AT THE MAXIMUM SOLDER BALL DIAMETER, PARALLEL TO PRIMARY DATUM C C



PRIMARY DATUM C A AND SEATING PLANE ARE DEFINED BY THE SPHERICAL CROWNS OF THE SOLDER BALLS.



BILATERAL TOLERANCE ZONE IS APPLIED TO EACH SIDE OF THE PACKAGE BODY.



EXACT SHAPE AND SIZE OF THIS FEATURE IS OPTIONAL.

SYMBOL	MIN.	NOM.	MAX.
A	-	-	1.00
A1	0.10	-	-
A2	-	-	0.90
D/E	4.00 BSC		
M/N	2.80 BSC		
S	0.20 BSC		
b	0.20	0.25	0.30
e	0.40 BSC		
aaa	-	-	0.10
bbb	-	-	0.10
ddd	-	-	0.08

64-Pin TQFP Package

Dimensions in Millimeters

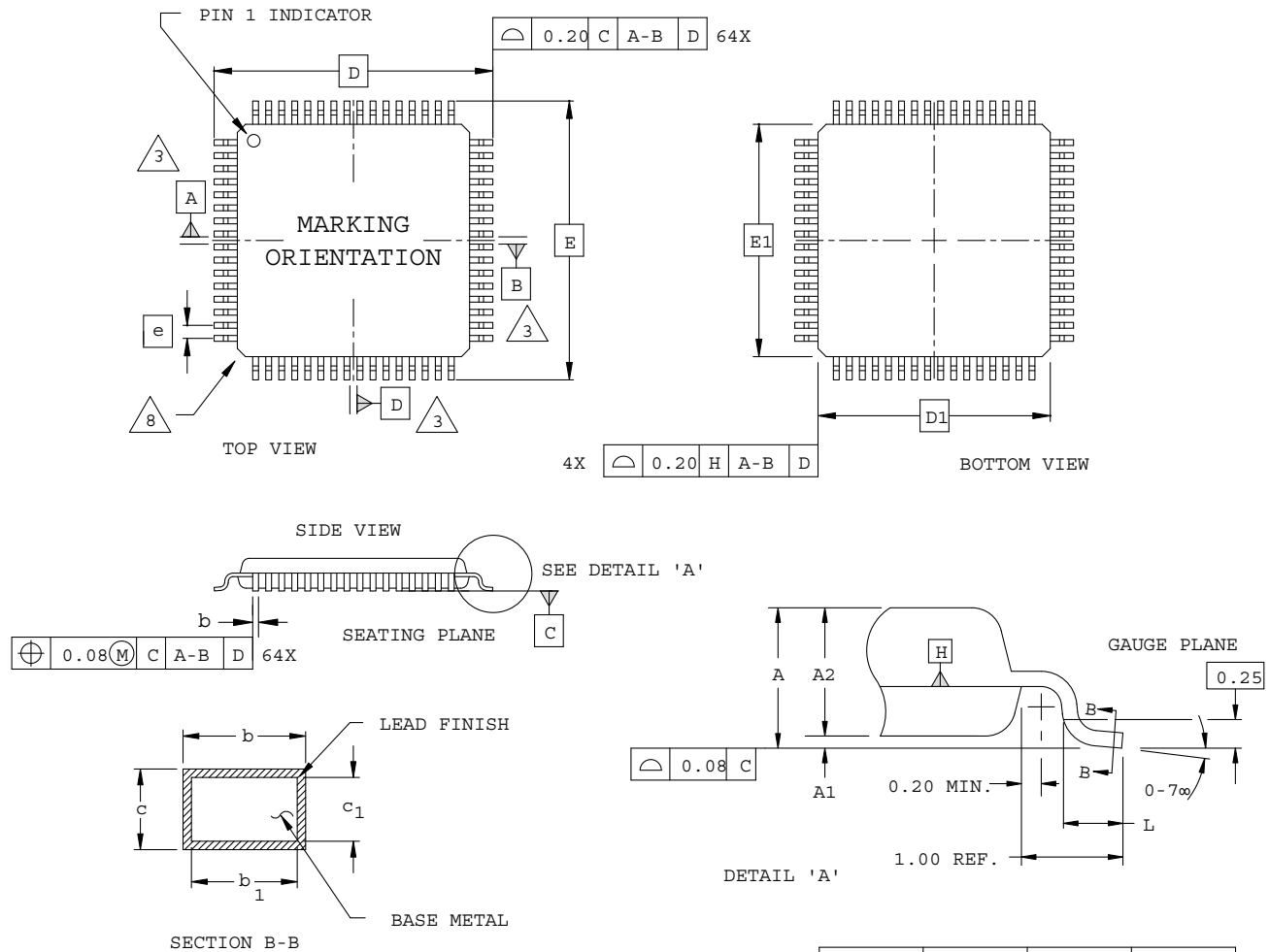

NOTES:

- DIMENSIONING AND TOLERANCING PER ANSI Y14.5 - 1982.
- ALL DIMENSIONS ARE IN MILLIMETERS.
- DATUMS A, B AND D TO BE DETERMINED AT DATUM PLANE H.
- DIMENSIONS D1 AND E1 DO NOT INCLUDE MOLD PROTRUSION. ALLOWABLE MOLD PROTRUSION IS 0.254 MM ON D1 AND E1 DIMENSIONS.
- THE TOP OF PACKAGE MAY BE SMALLER THAN THE BOTTOM OF THE PACKAGE BY 0.15 MM.
- SECTION B-B:
THESE DIMENSIONS APPLY TO THE FLAT SECTION OF THE LEAD BETWEEN 0.10 AND 0.25 MM FROM THE LEAD TIP.
- A1 IS DEFINED AS THE DISTANCE FROM THE SEATING PLANE TO THE LOWEST POINT ON THE PACKAGE BODY.
- EXACT SHAPE OF EACH CORNER IS OPTIONAL.

SYMBOL	MIN.	NOM.	MAX.
A	-	-	1.60
A1	0.05	-	0.15
A2	1.35	1.40	1.45
D	12.00 BSC		
D1	10.00 BSC		
E	12.00 BSC		
E1	10.00 BSC		
L	0.45	0.60	0.75
N	64		
e	0.50 BSC		
b	0.17	0.22	0.27
b1	0.17	0.20	0.23
c	0.09	-	0.20
c1	0.09	-	0.16

68-Pin JLCC Package

Dimensions in Inches

BOTTOM VIEW

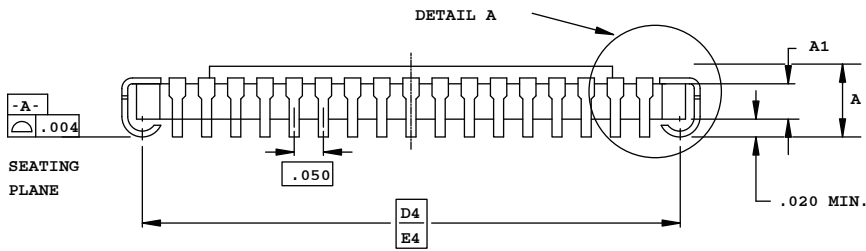
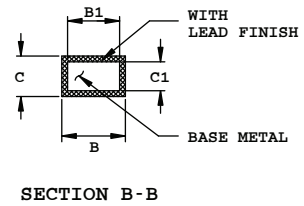
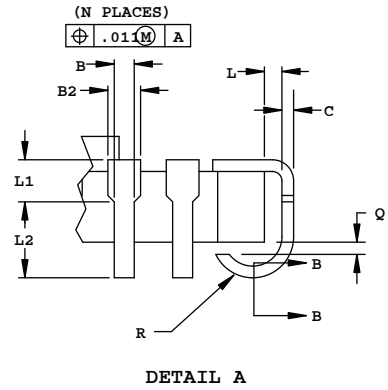
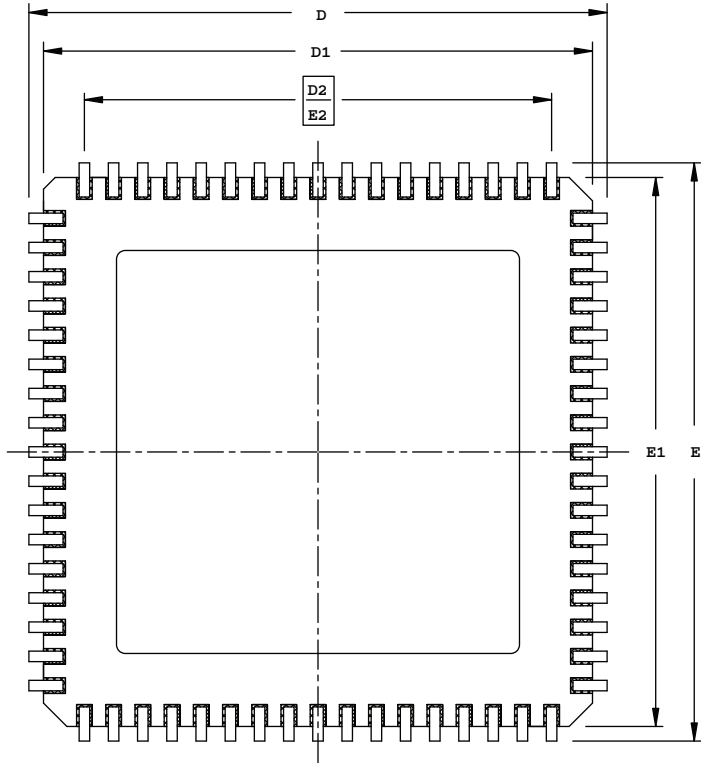

SIDE VIEW

NOTES:

1. DIMENSIONING AND TOLERANCING PER ANSI Y14.5M.
2. ALL DIMENSIONS ARE IN INCHES.
3. CORNER CHAMFERS AND/OR NOTCHES ARE OPTIONAL.

SYMBOL	INCHES	
	MIN.	MAX.
A	.115	-.190
A1	.080 REF	
B	.013	-.023
B1	.013	-.020
B2	.022	-.035
C	.007	-.013
C1	.007	-.010
D/E	.975	.990 1.000
D1/E1	.920	-.960
D2/E2	.800 BSC	
D4/E4	.930 BSC	
L	.005	-
L1	.020	-
L2	.025	-
Q	.003	-
R	.020	-.040
N	68	

68-Pin PLCC Package

Dimensions in Inches

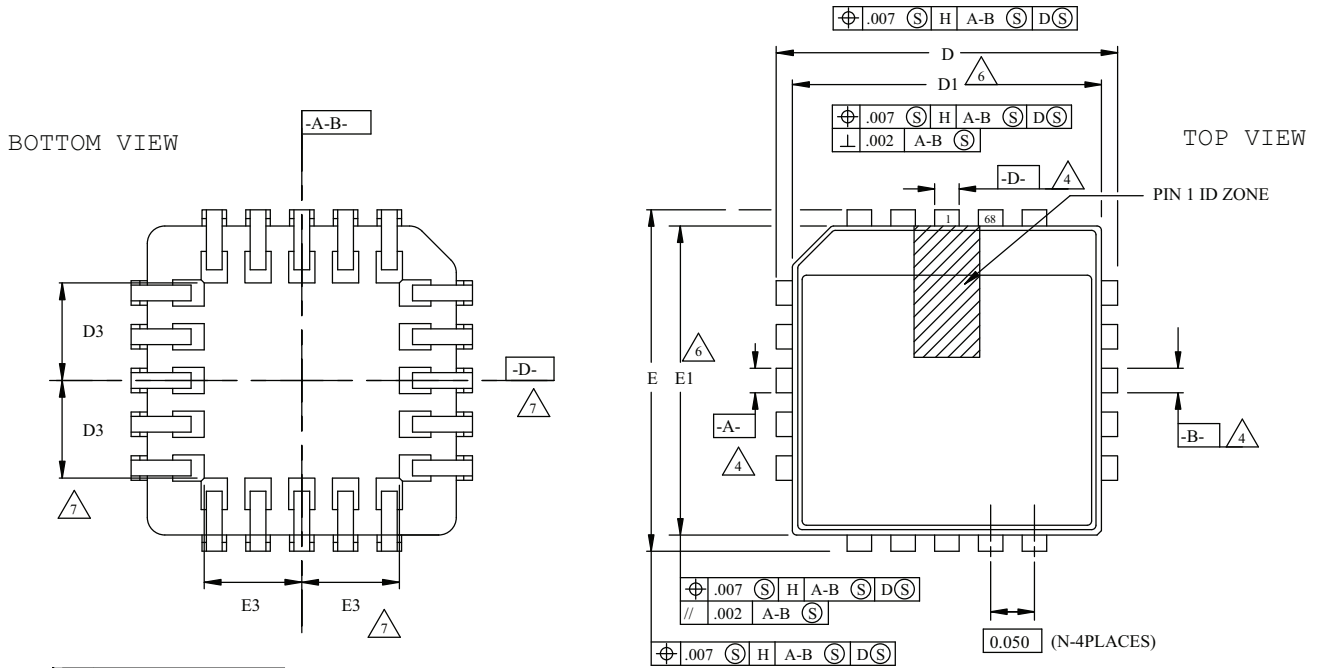

SYMBOL	DIMENSIONS		
	MIN.	NOM.	MAX.
A	.165	.172	.180
A1	.090	.105	.120
A2	.062	-	.083
D	.985	.990	.995
D1	.950	.954	.958
D2	.441	.455	.469
D3		.375	
E	.985	.990	.995
E1	.950	.954	.958
E2	.441	.455	.469
E3		.375	
N		68	

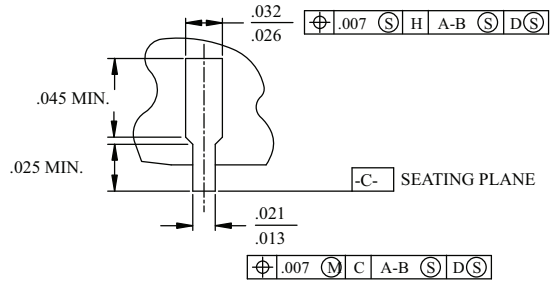
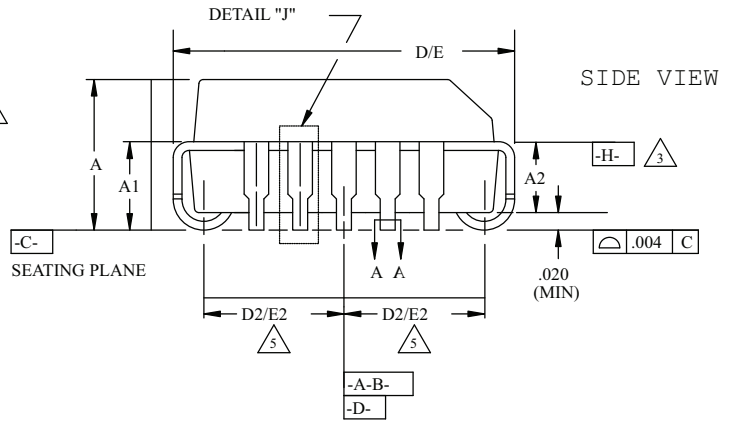
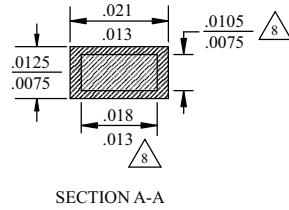

NOTES:

- ALL DIMENSIONS AND TOLERANCES CONFORM TO ANSI Y14.5M-1982
- ALL DIMENSIONS IN INCHES
- DATUM PLANE **-H-** LOCATED AT TOP OF MOLD PARTING LINE AND COINCIDENT WITH TOP OF LEAD WHERE LEAD EXITS PLASTIC BODY
- DATUMS **-A-B-** AND **-D-** TO BE DETERMINED WHERE CENTER LEADS EXIT PLASTIC BODY AT DATUM PLANE **-H-**
- TO BE MEASURED AT SEATING PLANE **-C-** CONTACT POINT
- DIMENSIONS D1 AND E1 DO NOT INCLUDE MOLD PROTRUSION. ALLOWABLE PROTRUSION IS .010 PER SIDE.
- TOP POINT OF MEASUREMENT IS DATUM **-H-**; BOTTOM POINT OF MEASUREMENT IS AT MAJOR FLAT AREA OF LOWER PLASTIC SURFACE DEFINED BY D3/E3
- DIMENSION APPLIES TO BASE METAL ONLY

DETAIL "J" (TYP ALL SIDES)

81-Ball csBGA Package

Dimensions in Millimeters

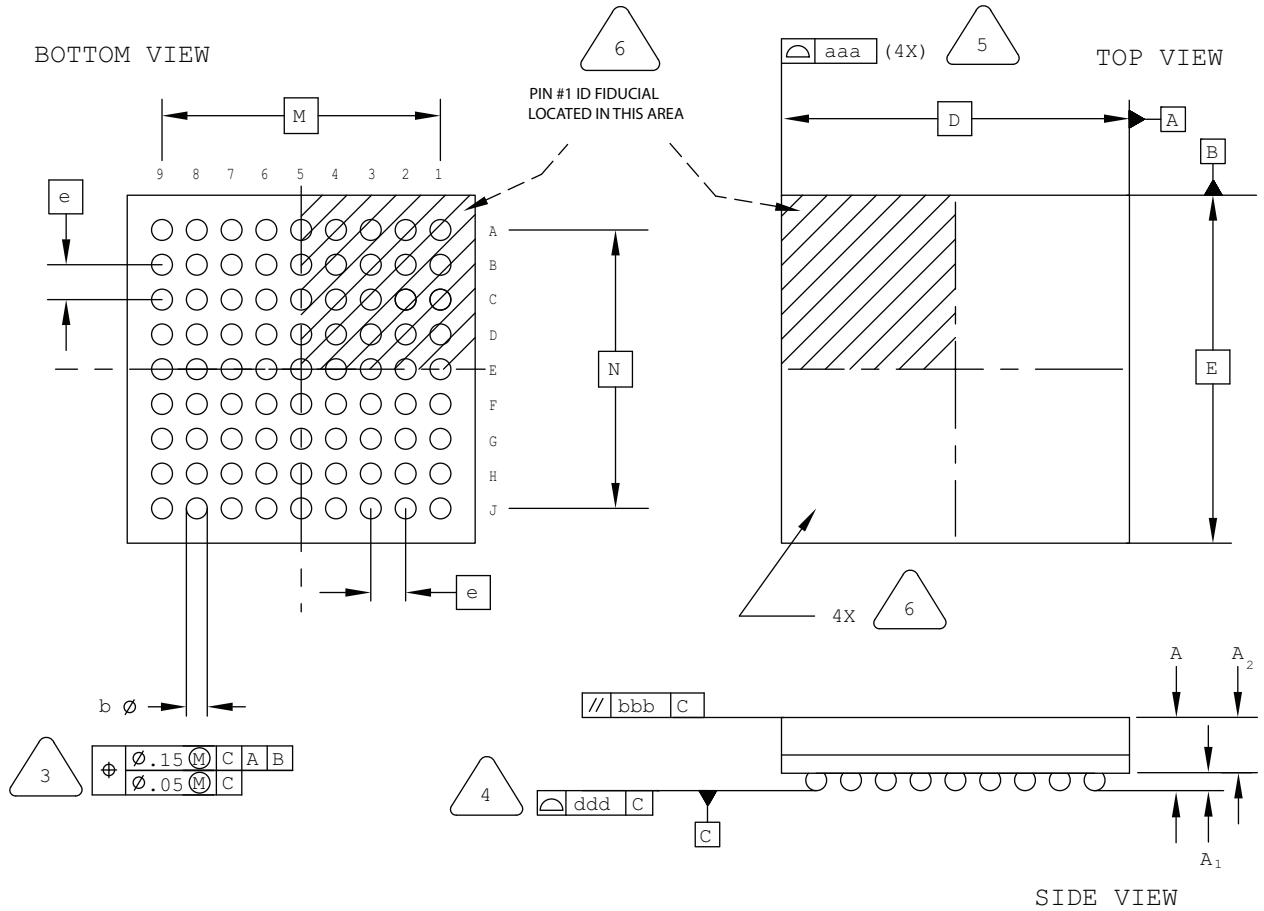

NOTES: UNLESS OTHERWISE SPECIFIED

- DIMENSIONS AND TOLERANCES PER ANSI Y14.5M.
- ALL DIMENSIONS ARE IN MILLIMETERS.

3 DIMENSION "b" IS MEASURED AT THE MAXIMUM SOLDER BALL DIAMETER, PARALLEL TO PRIMARY DATUM [C]

4 PRIMARY DATUM [C] AND SEATING PLANE ARE DEFINED BY THE SPHERICAL CROWNS OF THE SOLDER BALLS.

5 BILATERAL TOLERANCE ZONE IS APPLIED TO EACH SIDE OF THE PACKAGE BODY.

6 EXACT SHAPE AND SIZE OF THIS FEATURE IS OPTIONAL.

SYMBOL	MIN.	NOM.	MAX.
A	-	-	1.00
A1	0.10	-	-
A2	-	-	0.90
D/E	5.00 BSC		
M/N	4.00 BSC		
b	0.20	0.25	0.30
e	0.50 BSC		
aaa	-	-	0.10
bbb	-	-	0.10
ddd	-	-	0.10

81-Ball ucBGA Package

Dimensions in Millimeters

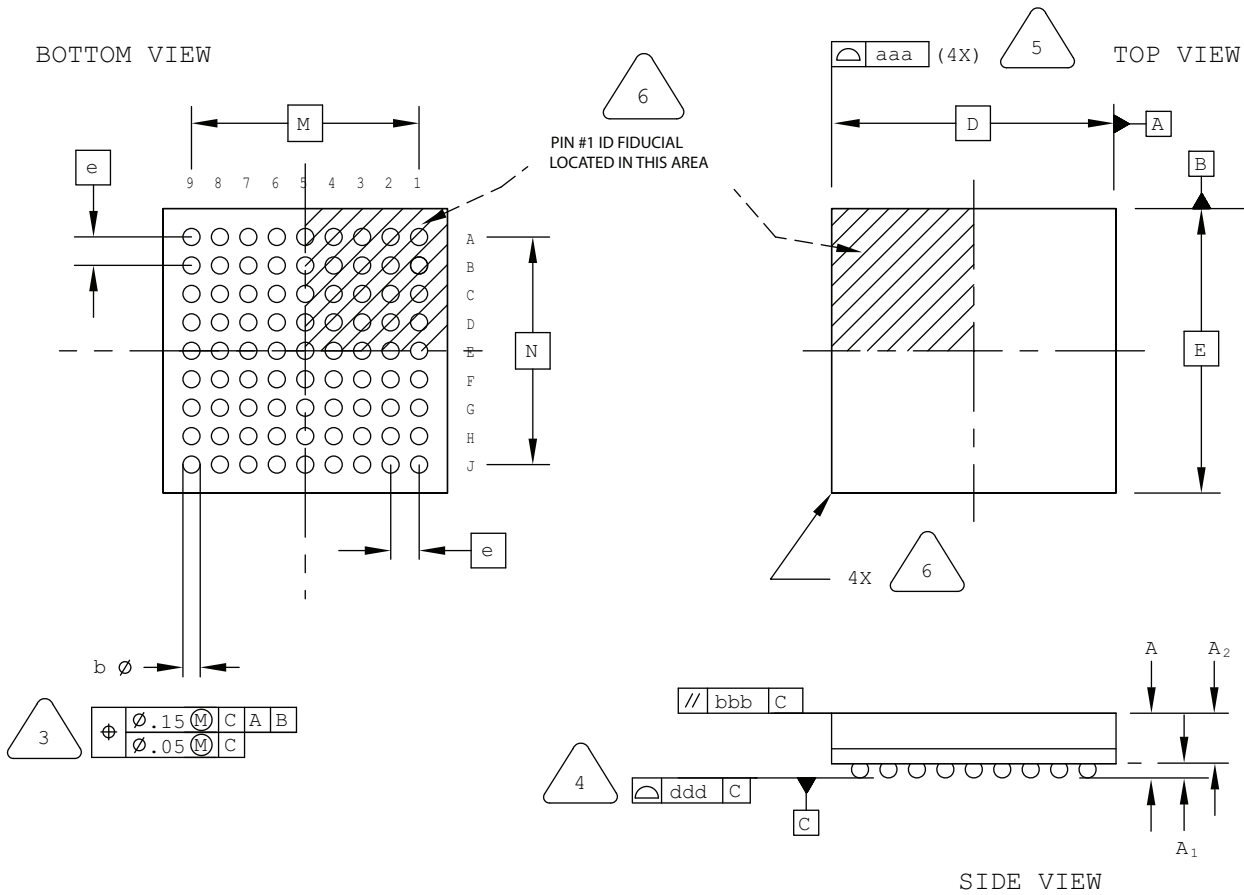

NOTES: UNLESS OTHERWISE SPECIFIED

- DIMENSIONS AND TOLERANCES PER ANSI Y14.5M.
- ALL DIMENSIONS ARE IN MILLIMETERS.

3 DIMENSION "b" IS MEASURED AT THE MAXIMUM SOLDER BALL DIAMETER, PARALLEL TO PRIMARY DATUM [C]

4 PRIMARY DATUM [C] AND SEATING PLANE ARE DEFINED BY THE SPHERICAL CROWNS OF THE SOLDER BALLS.

5 BILATERAL TOLERANCE ZONE IS APPLIED TO EACH SIDE OF THE PACKAGE BODY.

6 EXACT SHAPE AND SIZE OF THIS FEATURE IS OPTIONAL.

SYMBOL	MIN.	NOM.	MAX.
A	-	-	1.00
A1	0.10	-	-
A2	-	-	0.90
D/E	4.00 BSC		
M/N	3.20 BSC		
b	0.20	0.25	0.30
e	0.40 BSC		
aaa	-	-	0.10
bbb	-	-	0.10
ddd	-	-	0.10

81-Ball WLCS Package

Dimensions in Millimeters

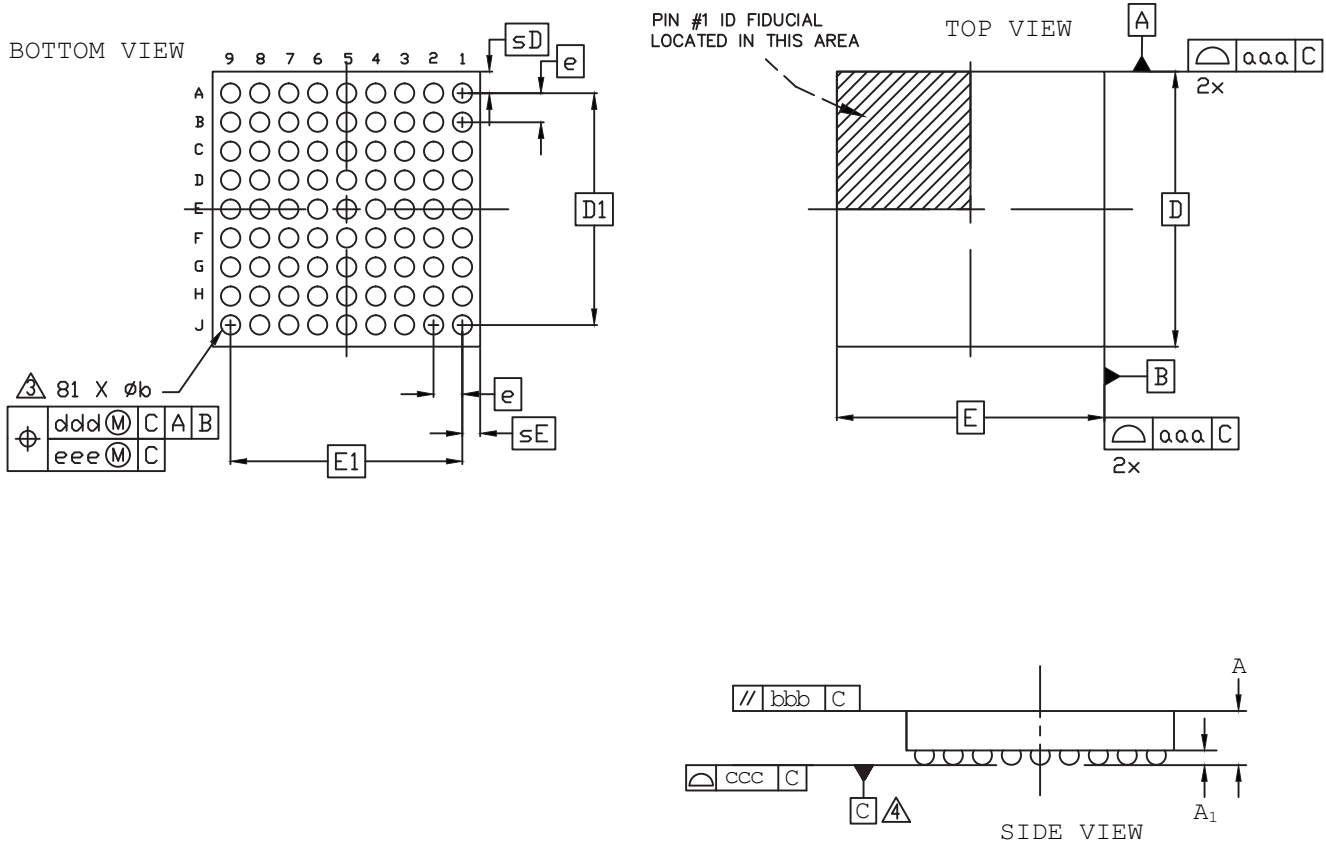

Notes:

- 1 ALL DIMENSIONS AND TOLERANCE PER ASME Y 14.5M - 1994.
- 2 ALL DIMENSIONS ARE IN MILLIMETERS.
- △ DIMENSION "b" IS MEASURED AT THE MAXIMUM BUMP DIAMETER PARALLEL TO PRIMARY DATUM [C].
- △ PRIMARY DATUM [C] AND SEATING PLANE ARE DEFINED BY THE SPHERICAL CROWNS OF THE SOLDER BUMPS.

REF.	Min.	Nom.	Max.
A	0.510	0.543	0.567
A1	0.167	0.196	0.225
b	0.239	0.266	0.319
D	3.797 BSC		
E	3.693 BSC		
D1	3.20 BSC		
E1	3.20 BSC		
e	0.40 BSC		
sD	-	0.299	-
sE	-	0.247	-
aaa	0.025		
bbb	0.060		
ccc	0.030		
ddd	0.015		
eee	0.050		

84-Pin CPGA Package

Dimensions in Inches

BOTTOM VIEW

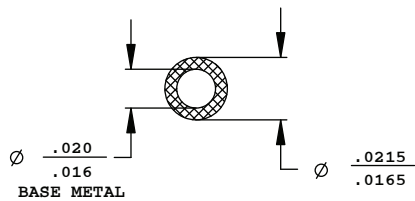
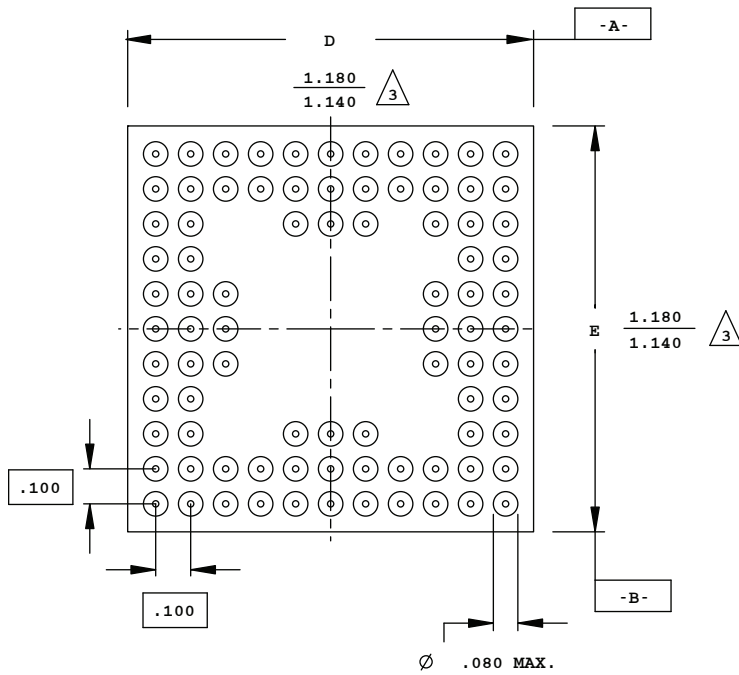

SECTION X-X

SIDE VIEW

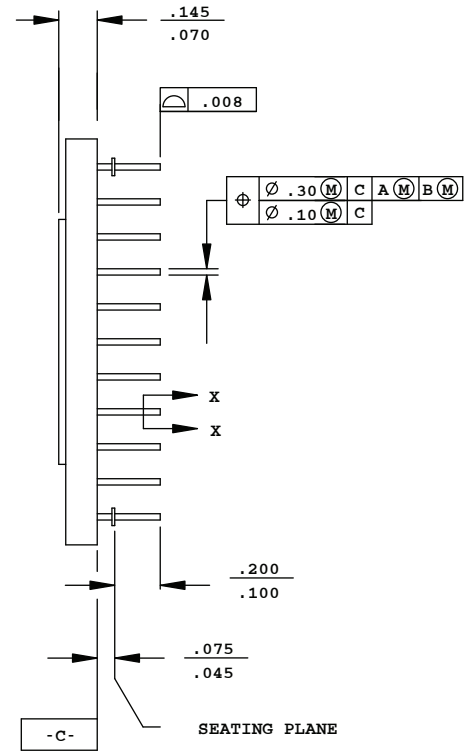

NOTES :

1. DIMENSIONING AND TOLERANCING PER ANSI Y14.5M.
2. ALL DIMENSIONS ARE IN INCHES.



DIMENSIONS D AND E MAY HAVE MATERIAL PROTRUSION OF $.006$ INCHES MAXIMUM ABOVE THE DIMENSION SHOWN NOT TO EXCEED $.003$ INCHES MAXIMUM PER SIDE.

84-Pin PLCC Package

Dimensions in Inches

BOTTOM VIEW

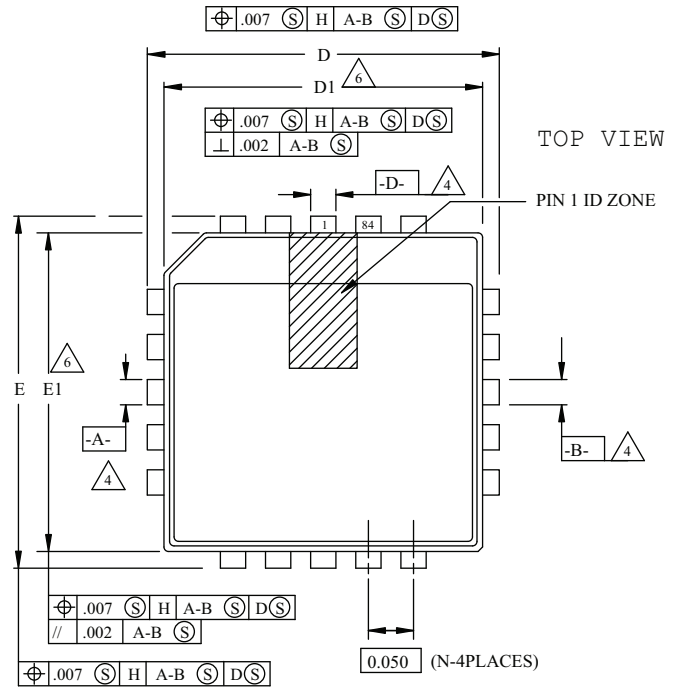
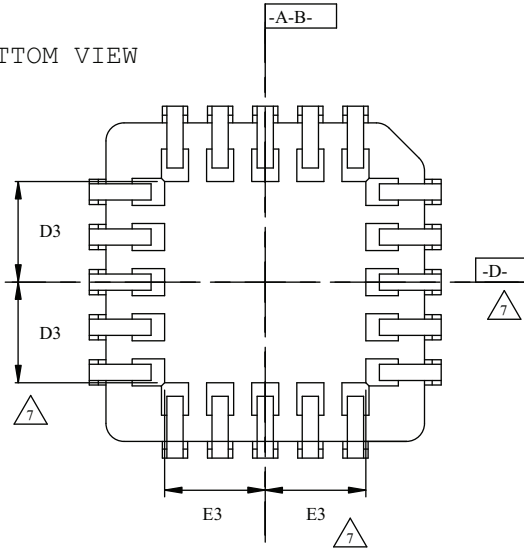

SYMBOL	DIMENSIONS		
	MIN.	NOM.	MAX.
A	.165	.172	.180
A1	.090	.105	.120
A2	.059	-	.080
D	1.185	1.190	1.195
D1	1.150	1.154	1.158
D2	.541	.555	.569
D3		.475	
E	1.185	1.190	1.195
E1	1.150	1.154	1.158
E2	.541	.555	.569
E3		.475	
N	84		

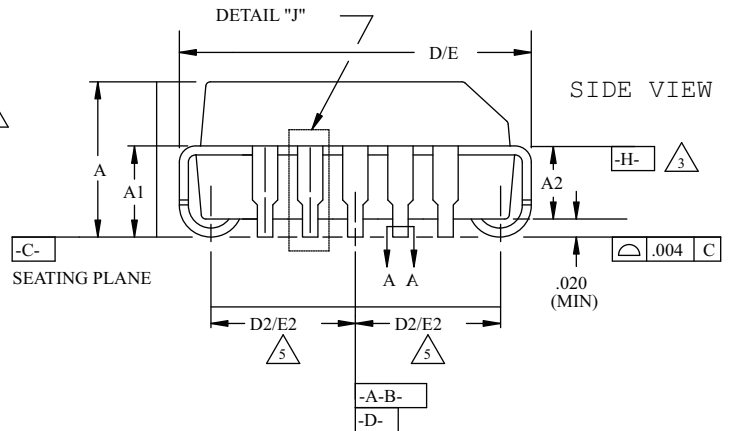
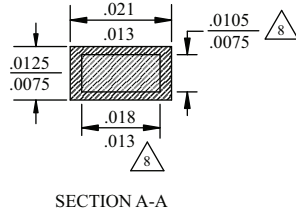

NOTES:

1. ALL DIMENSIONS AND TOLERANCES CONFORM TO ANSI Y14.5M-1982

2. ALL DIMENSIONS IN INCHES

- 3 DATUM PLANE -H- LOCATED AT TOP OF MOLD PARTING LINE AND COINCIDENT WITH TOP OF LEAD WHERE LEAD EXITS PLASTIC BODY
- 4 DATUMS -A-B- AND -D- TO BE DETERMINED WHERE CENTER LEADS EXIT PLASTIC BODY AT DATUM PLANE -H-
- 5 TO BE MEASURED AT SEATING PLANE -C- CONTACT POINT
- 6 DIMENSIONS D1 AND E1 DO NOT INCLUDE MOLD PROTRUSION. ALLOWABLE PROTRUSION IS .010 PER SIDE.
- 7 TOP POINT OF MEASUREMENT IS DATUM -H-; BOTTOM POINT OF MEASUREMENT IS AT MAJOR FLAT AREA OF LOWER PLASTIC SURFACE DEFINED BY D3/E3
- 8 DIMENSION APPLIES TO BASE METAL ONLY

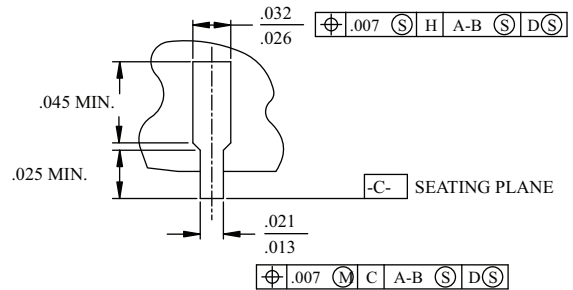

DETAIL "J" (TYP ALL SIDES)

84-Pin QFN Package

Dimensions in Millimeters

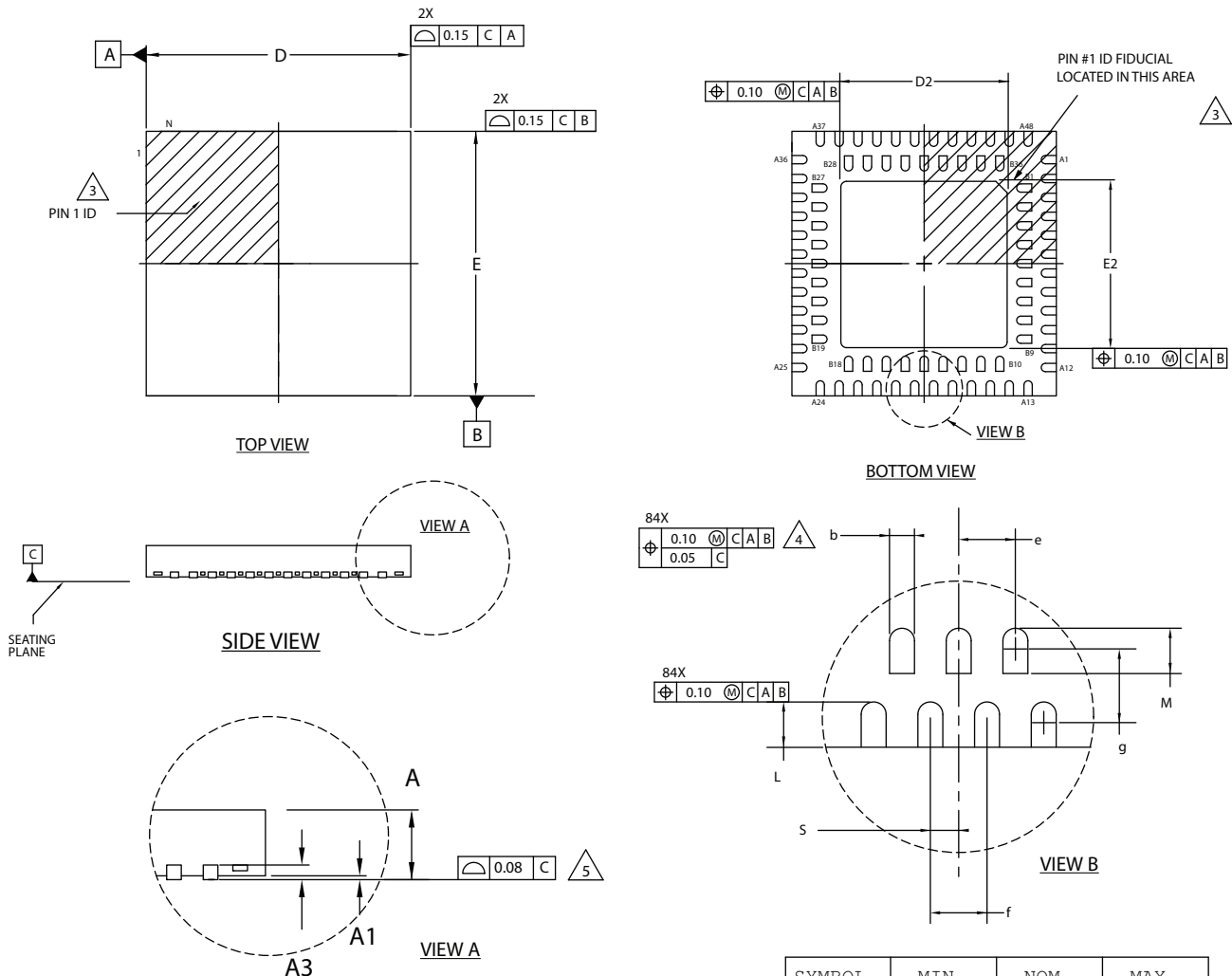

NOTES: UNLESS OTHERWISE SPECIFIED

1. DIMENSIONS AND TOLERANCES PER ANSI Y14.5M.
2. ALL DIMENSIONS ARE IN MILLIMETERS.

 EXACT SHAPE AND SIZE OF THIS FEATURE IS OPTIONAL.

 DIMENSION b APPLIES TO PLATED TERMINAL AND IS MEASURED BETWEEN 0.15 AND 0.30 mm FROM TERMINAL TIP.

 APPLIES TO EXPOSED PORTION OF TERMINALS.

SYMBOL	MIN.	NOM.	MAX.
A	0.75	0.85	0.95
A1	0.00	0.02	0.05
A3	0.15 REF		
D	7.0 BSC		
D2	4.30	-	4.50
E	7.0 BSC		
E2	4.30	-	4.50
b	0.17	0.22	0.27
e	0.50 BSC		
f	0.50 BSC		
g	0.65 BSC		
S	0.25 BSC		
L	0.30	0.40	0.50
M	0.30	0.40	0.50

100-Ball caBGA Package

Dimensions in Millimeters

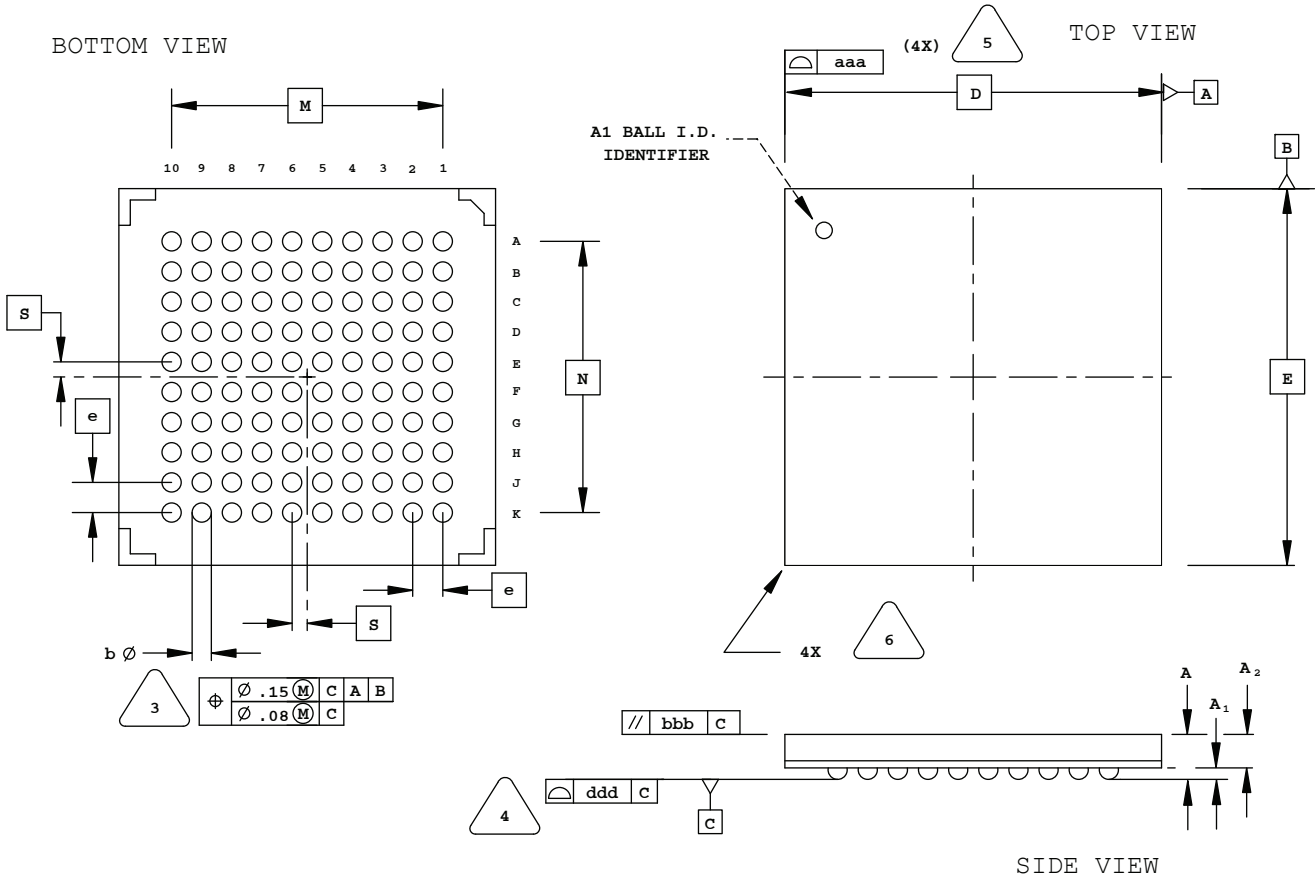

NOTES: UNLESS OTHERWISE SPECIFIED

- DIMENSIONS AND TOLERANCES PER ANSI Y14.5M.
- ALL DIMENSIONS ARE IN MILLIMETERS.



DIMENSION "b" IS MEASURED AT THE MAXIMUM SOLDER BALL DIAMETER, PARALLEL TO PRIMARY DATUM **C**



PRIMARY DATUM **C** AND SEATING PLANE ARE DEFINED BY THE SPHERICAL CROWNS OF THE SOLDER BALLS.



BILATERAL TOLERANCE ZONE IS APPLIED TO EACH SIDE OF THE PACKAGE BODY.



EXACT SHAPE AND SIZE OF THIS FEATURE IS OPTIONAL.

SYMBOL	MIN.	NOM.	MAX.
A	1.30	1.40	1.50
A1	0.31	0.36	0.41
A2	0.99	1.04	1.09
D/E	10.00 BSC		
M/N	7.20 BSC		
S	0.40 BSC		
b	0.40	0.46	0.52
e	0.80 BSC		
aaa	-	-	0.10
bbb	-	-	0.10
ddd	-	-	0.12

100-Ball csBGA Package

Dimensions in Millimeters

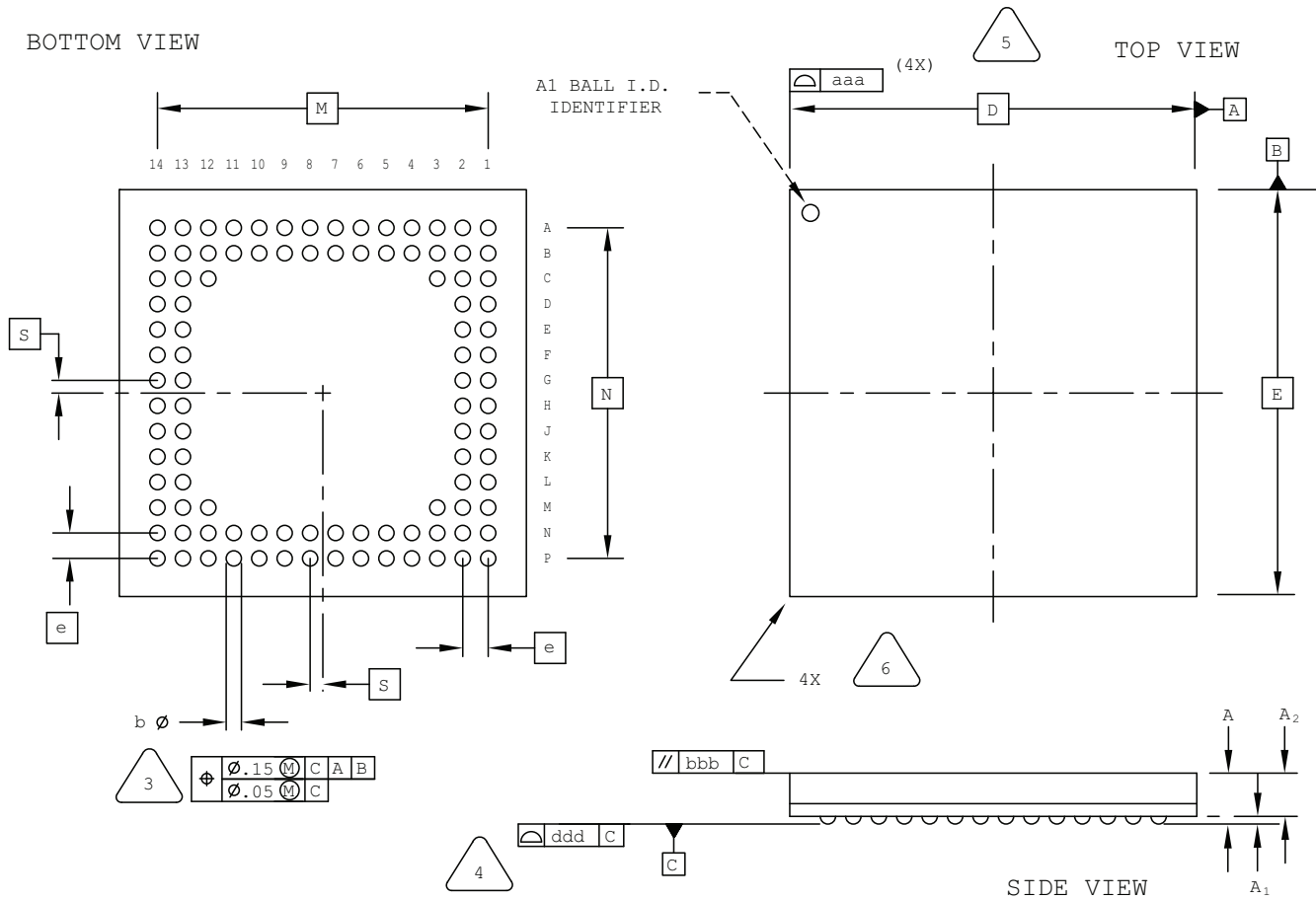

NOTES: UNLESS OTHERWISE SPECIFIED

1. DIMENSIONS AND TOLERANCES PER ANSI Y14.5M.
2. ALL DIMENSIONS ARE IN MILLIMETERS.



DIMENSION "b" IS MEASURED AT THE MAXIMUM SOLDER BALL DIAMETER, PARALLEL TO PRIMARY DATUM [C]



PRIMARY DATUM [C] AND SEATING PLANE ARE DEFINED BY THE SPHERICAL CROWNS OF THE SOLDER BALLS.



BILATERAL TOLERANCE ZONE IS APPLIED TO EACH SIDE OF THE PACKAGE BODY.



EXACT SHAPE AND SIZE OF THIS FEATURE IS OPTIONAL.

SYMBOL	MIN.	NOM.	MAX.
A	0.90	1.23	1.35
A1	0.15	-	-
A2	-	-	1.10
D/E	8.00 BSC		
M/N	6.50 BSC		
S	0.25 BSC		
b	0.25	0.30	0.35
e	0.50 BSC		
aaa	-	-	0.10
bbb	-	-	0.10
ddd	-	-	0.08

100-Ball fpBGA Package

Dimensions in Millimeters

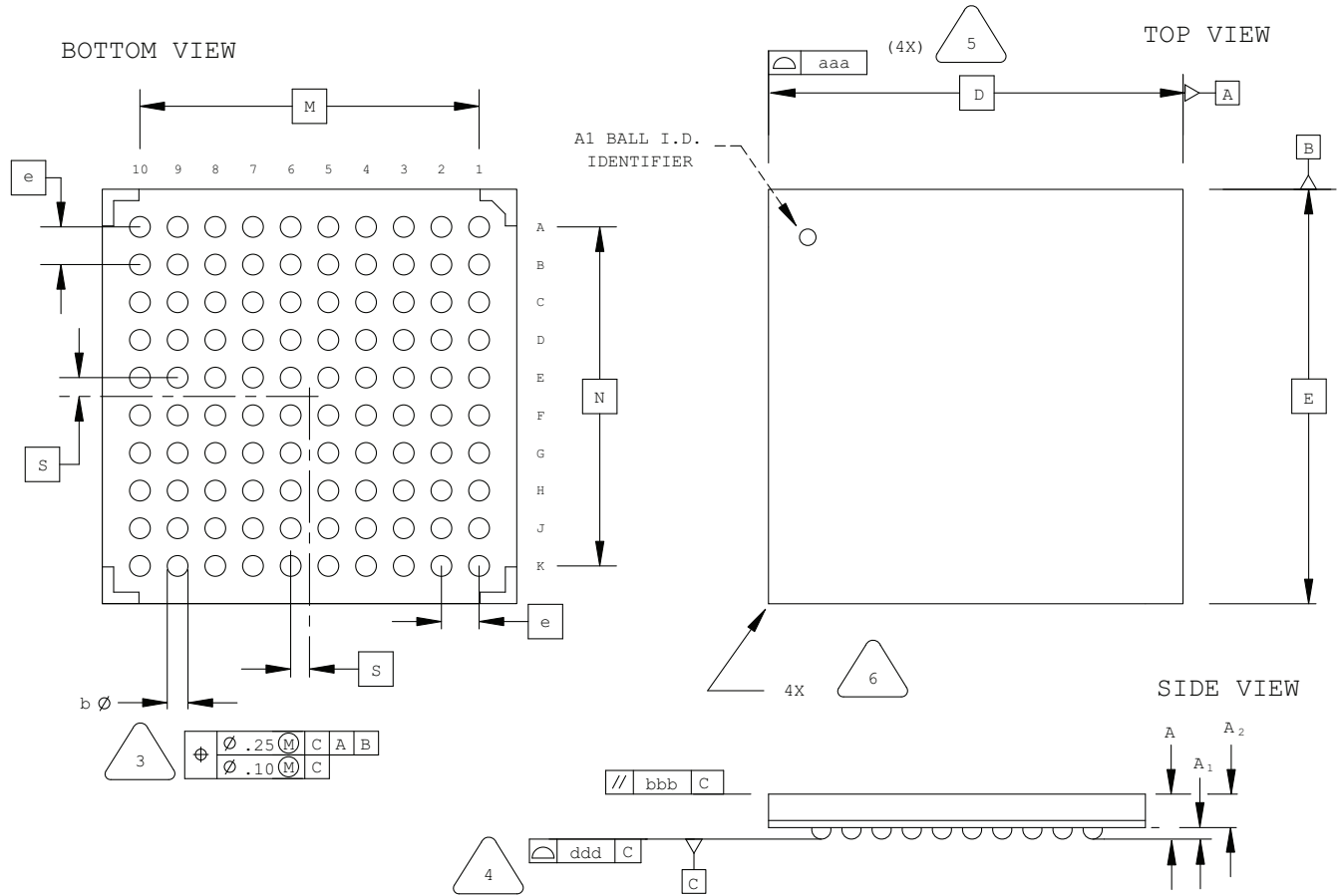

NOTES: UNLESS OTHERWISE SPECIFIED

1. DIMENSIONS AND TOLERANCES PER ANSI Y14.5M.
2. ALL DIMENSIONS ARE IN MILLIMETERS.



DIMENSION "b" IS MEASURED AT THE MAXIMUM SOLDER BALL DIAMETER, PARALLEL TO PRIMARY DATUM [C]



PRIMARY DATUM [C] AND SEATING PLANE ARE DEFINED BY THE SPHERICAL CROWNS OF THE SOLDER BALLS.



BILATERAL TOLERANCE ZONE IS APPLIED TO EACH SIDE OF THE PACKAGE BODY.



EXACT SHAPE AND SIZE OF THIS FEATURE IS OPTIONAL.

SYMBOL	MIN.	NOM.	MAX.
A	1.30	1.50	1.70
A1	0.30	0.50	0.70
A2	1.10 REF		
D/E	11.00 BSC		
M/N	9.00 BSC		
S	0.50 BSC		
b	0.40	0.55	0.70
e	1.00 BSC		
aaa	-	-	0.20
bbb	-	-	0.25
ddd	-	-	0.20

100-Pin PQFP Package

Dimensions in Millimeters

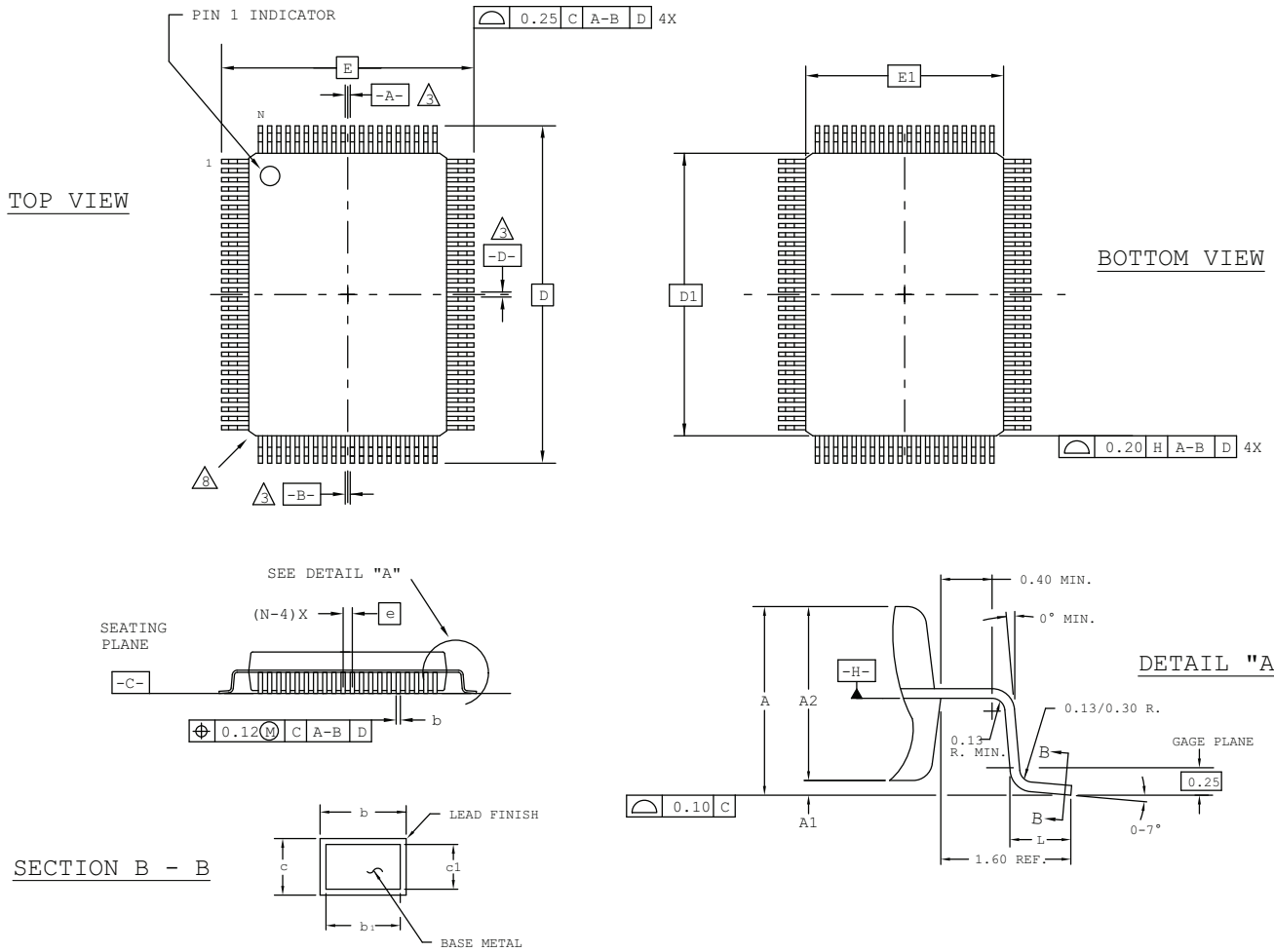

NOTES:

- 1.0 DIMENSIONING AND TOLERANCING PER ANSI Y14.5 - 1982.
- 2.0 ALL DIMENSIONS ARE IN MILLIMETERS.
- 3.0 DATUMS A, B AND D TO BE DETERMINED AT DATUM PLANE H.
- 4.0 DIMENSIONS D1 AND E1 DO NOT INCLUDE MOLD PROTRUSION. ALLOWABLE MOLD PROTRUSION IS 0.254 MM ON D1 AND E1 DIMENSIONS.
- 5.0 THE TOP OF PACKAGE MAY BE SMALLER THAN THE BOTTOM OF THE PACKAGE BY 0.15 MM.
- 6.0 SECTION B-B:
THESE DIMENSIONS APPLY TO THE FLAT SECTION OF THE LEAD BETWEEN 0.10 AND 0.25 MM FROM THE LEAD TIP.
- 7.0 A1 IS DEFINED AS THE DISTANCE FROM THE SEATING PLANE TO THE LOWEST POINT ON THE PACKAGE BODY.
- 8.0 EXACT SHAPE OF EACH CORNER IS OPTIONAL.
- 9.0 EXACT SHAPE OF EXPOSED HEATSINK IS OPTIONAL.

SYMBOL	MIN.	NOM.	MAX.
A	-	-	3.40
A1	0.25	-	0.50
A2	2.50	2.70	2.90
D	23.20 BSC		
D1	20.00 BSC		
E	17.20 BSC		
E1	14.00 BSC		
L	0.73	0.88	1.03
N	100		
e	0.65 BSC		
b	0.22	-	0.40
b1	0.22	0.30	0.36
c	0.11	-	0.23
c1	0.11	0.15	0.19

100-Pin TQFP Package Option 1: MachXO2, MachXO™

Dimensions in Millimeters

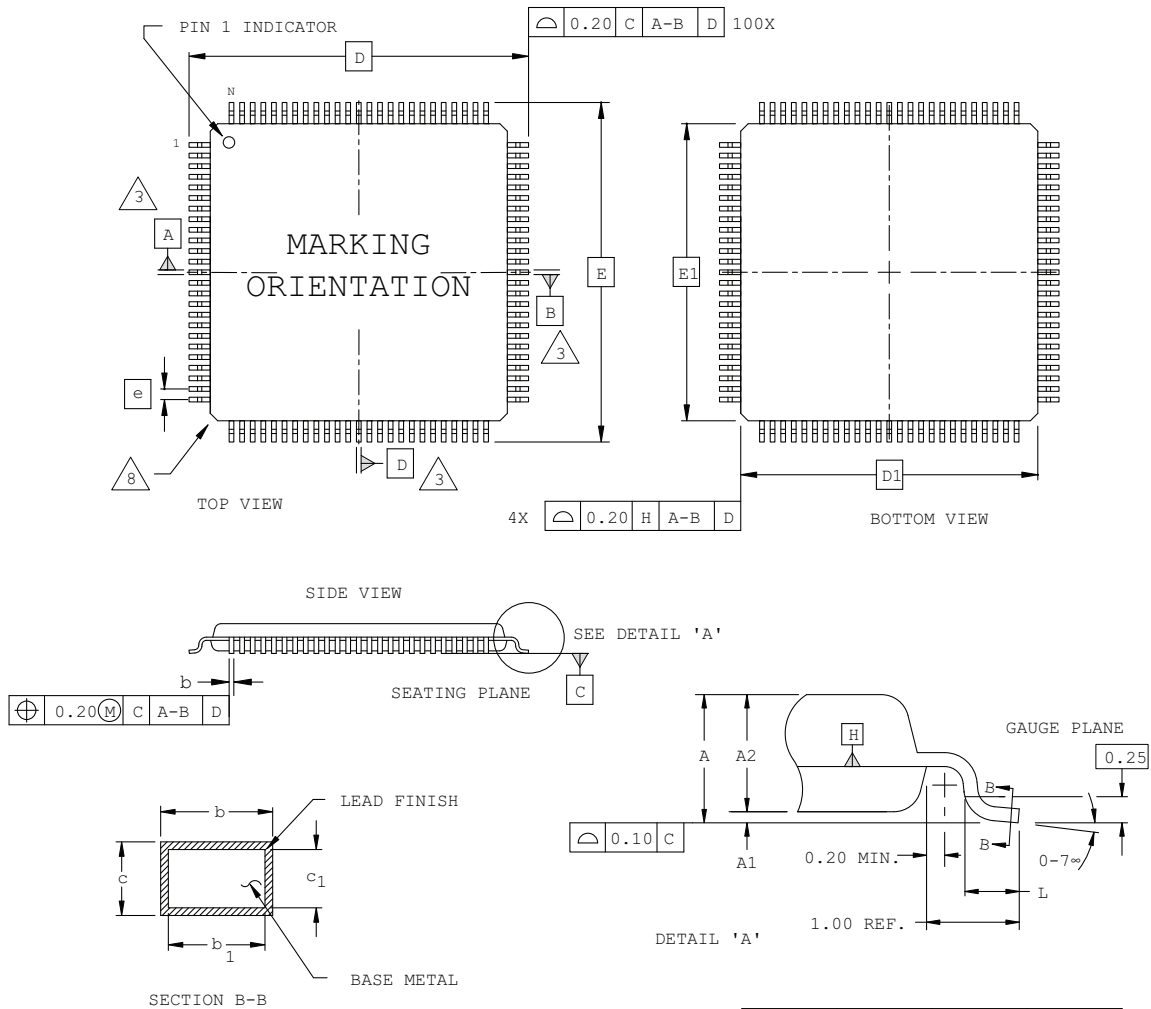

NOTES:

- DIMENSIONING AND TOLERANCING PER ANSI Y14.5 - 1982.
- ALL DIMENSIONS ARE IN MILLIMETERS.
- DATUMS A, B AND D TO BE DETERMINED AT DATUM PLANE H.
- DIMENSIONS D1 AND E1 DO NOT INCLUDE MOLD PROTRUSION. ALLOWABLE MOLD PROTRUSION IS 0.254 MM ON D1 AND E1 DIMENSIONS.
- THE TOP OF PACKAGE MAY BE SMALLER THAN THE BOTTOM OF THE PACKAGE BY 0.15 MM.
- SECTION B-B:
THESE DIMENSIONS APPLY TO THE FLAT SECTION OF THE LEAD BETWEEN 0.10 AND 0.25 MM FROM THE LEAD TIP.
- A1 IS DEFINED AS THE DISTANCE FROM THE SEATING PLANE TO THE LOWEST POINT ON THE PACKAGE BODY.
- EXACT SHAPE OF EACH CORNER IS OPTIONAL.

SYMBOL	MIN.	NOM.	MAX.
A	-	-	1.60
A1	0.05	-	0.15
A2	1.35	1.40	1.45
D	16.00 BSC		
D1	14.00 BSC		
E	16.00 BSC		
E1	14.00 BSC		
L	0.45	0.60	0.75
N	100		
e	0.50 BSC		
b	0.17	0.22	0.27
b1	0.17	0.20	0.23
c	0.09	0.15	0.20
c1	0.09	0.13	0.16

100-Pin VQFP Package Option 2: iCE40

Dimensions in Millimeters

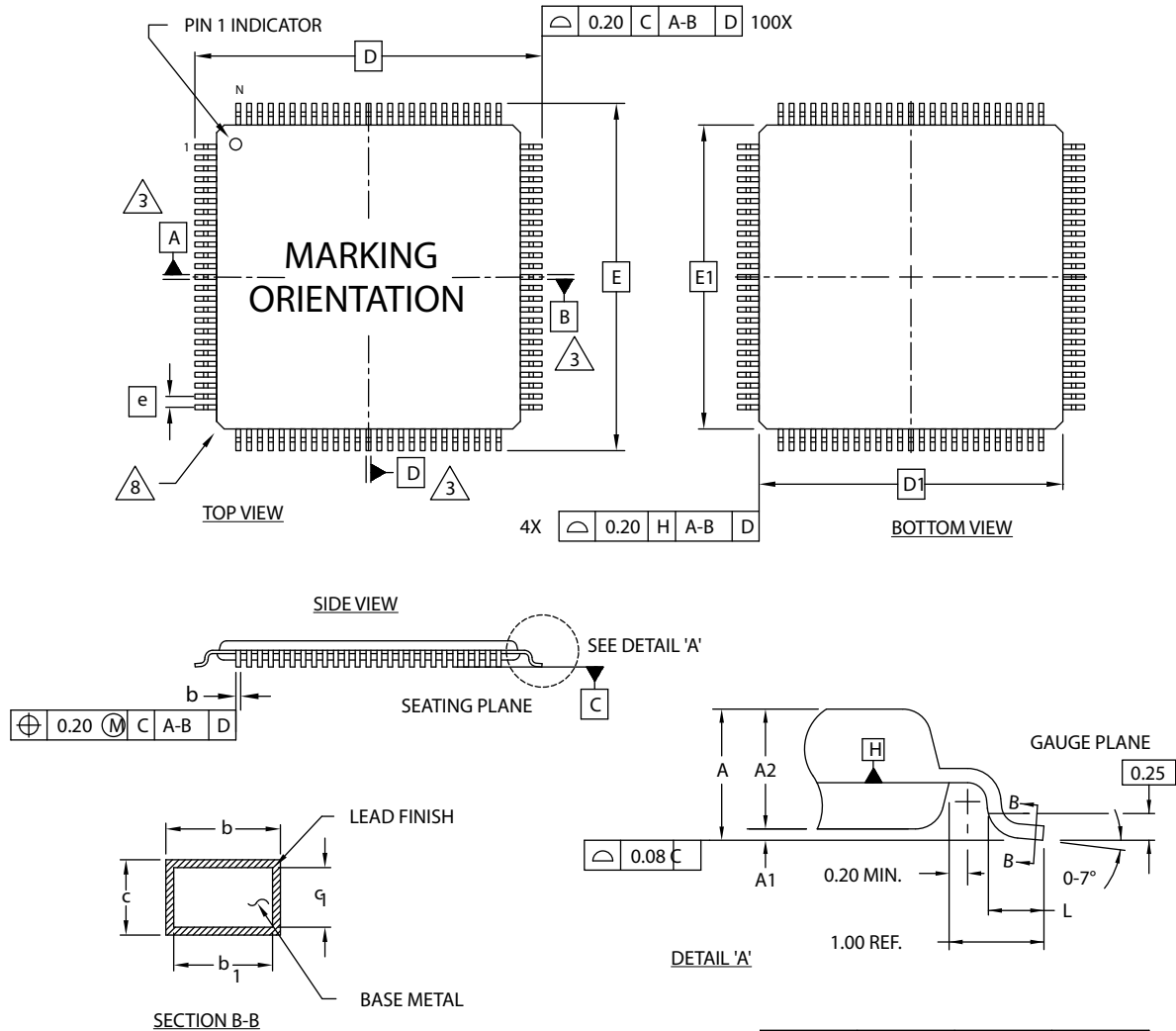

NOTES:

1. DIMENSIONING AND TOLERANCING PER ANSI Y14.5 - 1982.
2. ALL DIMENSIONS ARE IN MILLIMETERS.
3. DATUMS A, B AND D TO BE DETERMINED AT DATUM PLANE H.
4. DIMENSIONS D1 AND E1 DO NOT INCLUDE MOLD PROTRUSION. ALLOWABLE MOLD PROTRUSION IS 0.254 MM ON D1 AND E1 DIMENSIONS.
5. THE TOP OF PACKAGE MAY BE SMALLER THAN THE BOTTOM OF THE PACKAGE BY 0.15 MM.
6. SECTION B-B:
THESE DIMENSIONS APPLY TO THE FLAT SECTION OF THE LEAD BETWEEN 0.10 AND 0.25 MM FROM THE LEAD TIP.
7. A1 IS DEFINED AS THE DISTANCE FROM THE SEATING PLANE TO THE LOWEST POINT ON THE PACKAGE BODY.
8. EXACT SHAPE OF EACH CORNER IS OPTIONAL.

SYMBOL	MIN.	NOM.	MAX.
A	-	-	1.20
A1	0.05	-	0.15
A2	0.95	1.00	1.05
D	16.00 BSC		
D1	14.00 BSC		
E	16.00 BSC		
E1	14.00 BSC		
L	0.45	0.60	0.75
N	100		
e	0.50 BSC		
b	0.17	0.22	0.27
b1	0.17	0.20	0.23
c	0.09	0.15	0.20
c1	0.09	0.13	0.16

120-Pin PQFP Package

Dimensions in Millimeters

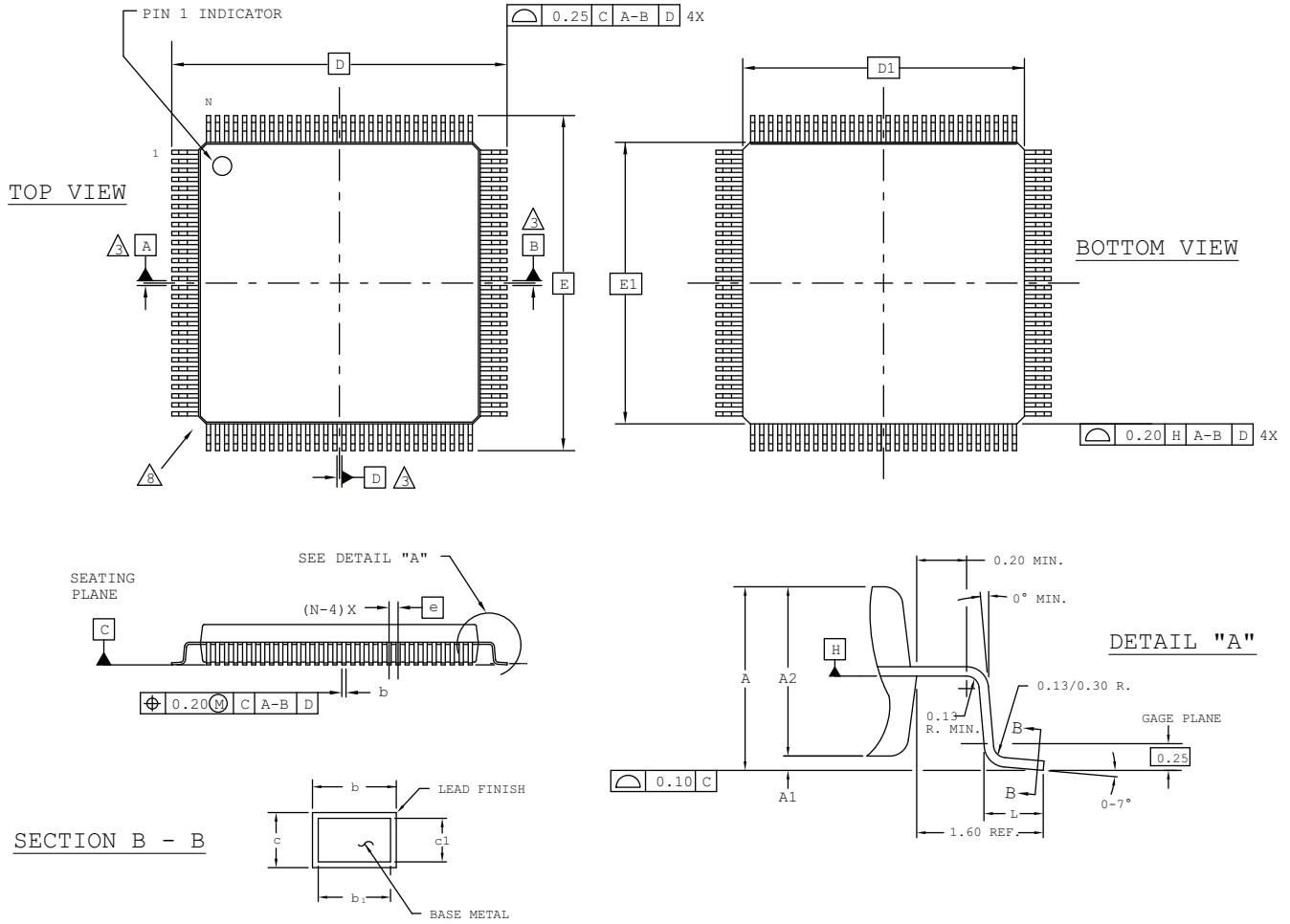

NOTES:

- 1.0 DIMENSIONING AND TOLERANCING PER ANSI Y14.5 - 1982.
- 2.0 ALL DIMENSIONS ARE IN MILLIMETERS.
- 3.0 DATUMS A, B AND D TO BE DETERMINED AT DATUM PLANE H.
- 4.0 DIMENSIONS D1 AND E1 DO NOT INCLUDE MOLD PROTRUSION. ALLOWABLE MOLD PROTRUSION IS 0.254 MM ON D1 AND E1 DIMENSIONS.
- 5.0 THE TOP OF PACKAGE MAY BE SMALLER THAN THE BOTTOM OF THE PACKAGE BY 0.15 MM.
- 6.0 SECTION B-B:
THESE DIMENSIONS APPLY TO THE FLAT SECTION OF THE LEAD BETWEEN 0.10 AND 0.25 MM FROM THE LEAD TIP.
- 7.0 A1 IS DEFINED AS THE DISTANCE FROM THE SEATING PLANE TO THE LOWEST POINT ON THE PACKAGE BODY.
- 8.0 EXACT SHAPE OF EACH CORNER IS OPTIONAL.
- 9.0 EXACT SHAPE OF EXPOSED HEATSINK IS OPTIONAL.

SYMBOL	MIN.	NOM.	MAX.
A	-	-	4.10
A1	0.25	-	0.50
A2	3.20	3.40	3.60
D	31.20 BSC		
D1	28.00 BSC		
E	31.20 BSC		
E1	28.00 BSC		
L	0.73	0.88	1.03
N	120		
e	0.80 BSC		
b	0.29	-	0.45
b1	0.29	0.35	0.41
c	0.11	-	0.23
c1	0.11	0.15	0.19

121-Ball csBGA Package

Dimensions in Millimeters

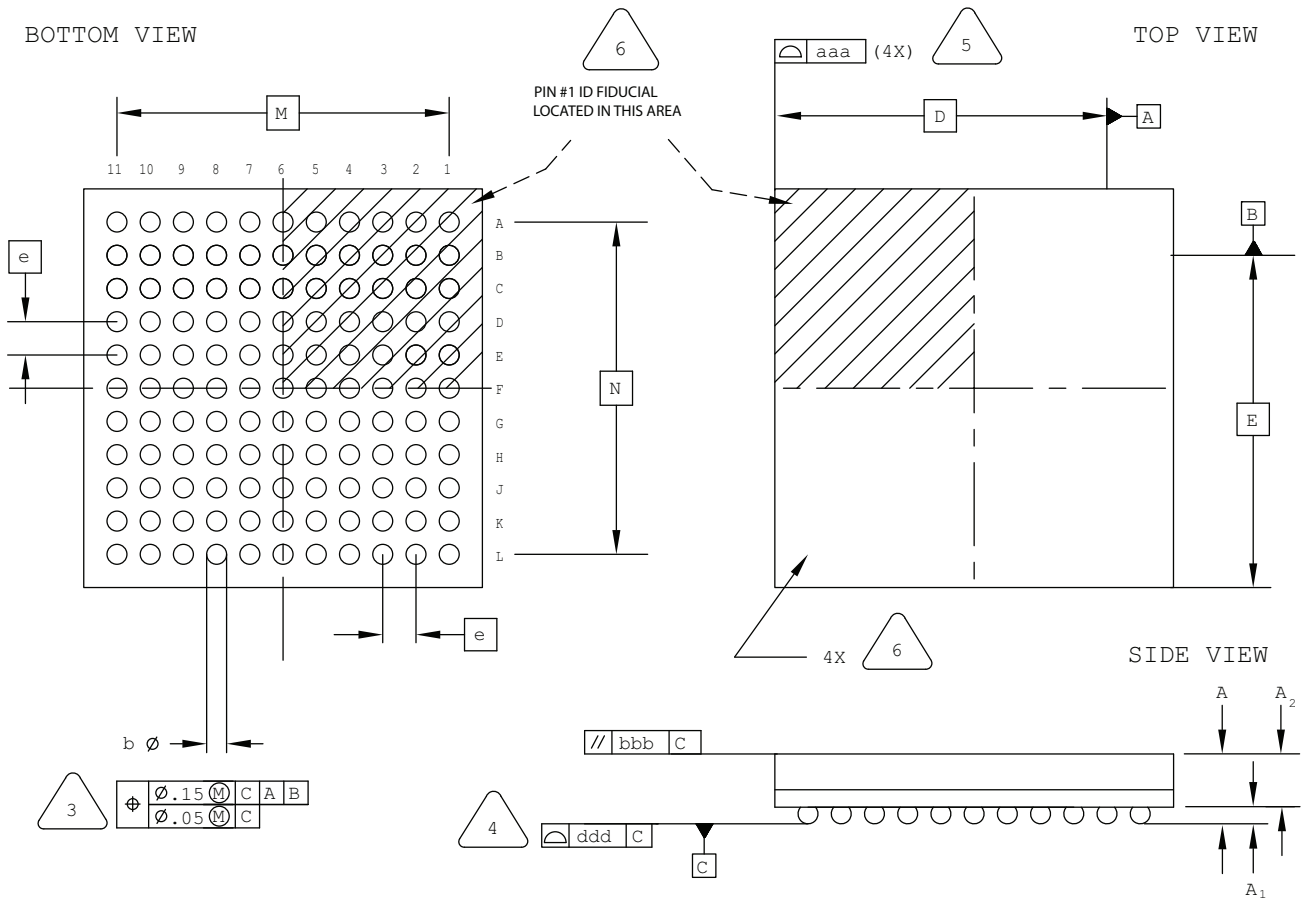

NOTES: UNLESS OTHERWISE SPECIFIED

- DIMENSIONS AND TOLERANCES PER ANSI Y14.5M.
- ALL DIMENSIONS ARE IN MILLIMETERS.

3 DIMENSION "b" IS MEASURED AT THE MAXIMUM SOLDER BALL DIAMETER, PARALLEL TO PRIMARY DATUM [C]

4 PRIMARY DATUM [C] AND SEATING PLANE ARE DEFINED BY THE SPHERICAL CROWNS OF THE SOLDER BALLS.

5 BILATERAL TOLERANCE ZONE IS APPLIED TO EACH SIDE OF THE PACKAGE BODY.

6 EXACT SHAPE AND SIZE OF THIS FEATURE IS OPTIONAL.

SYMBOL	MIN.	NOM.	MAX.
A	-	-	1.00
A1	0.10	-	-
A2	-	-	0.90
D/E	6.00 BSC		
M/N	5.00 BSC		
b	0.20	0.25	0.30
e	0.50 BSC		
aaa	-	-	0.10
bbb	-	-	0.10
ddd	-	-	0.10

121-Ball csfBGA Package

Dimensions in Millimeters

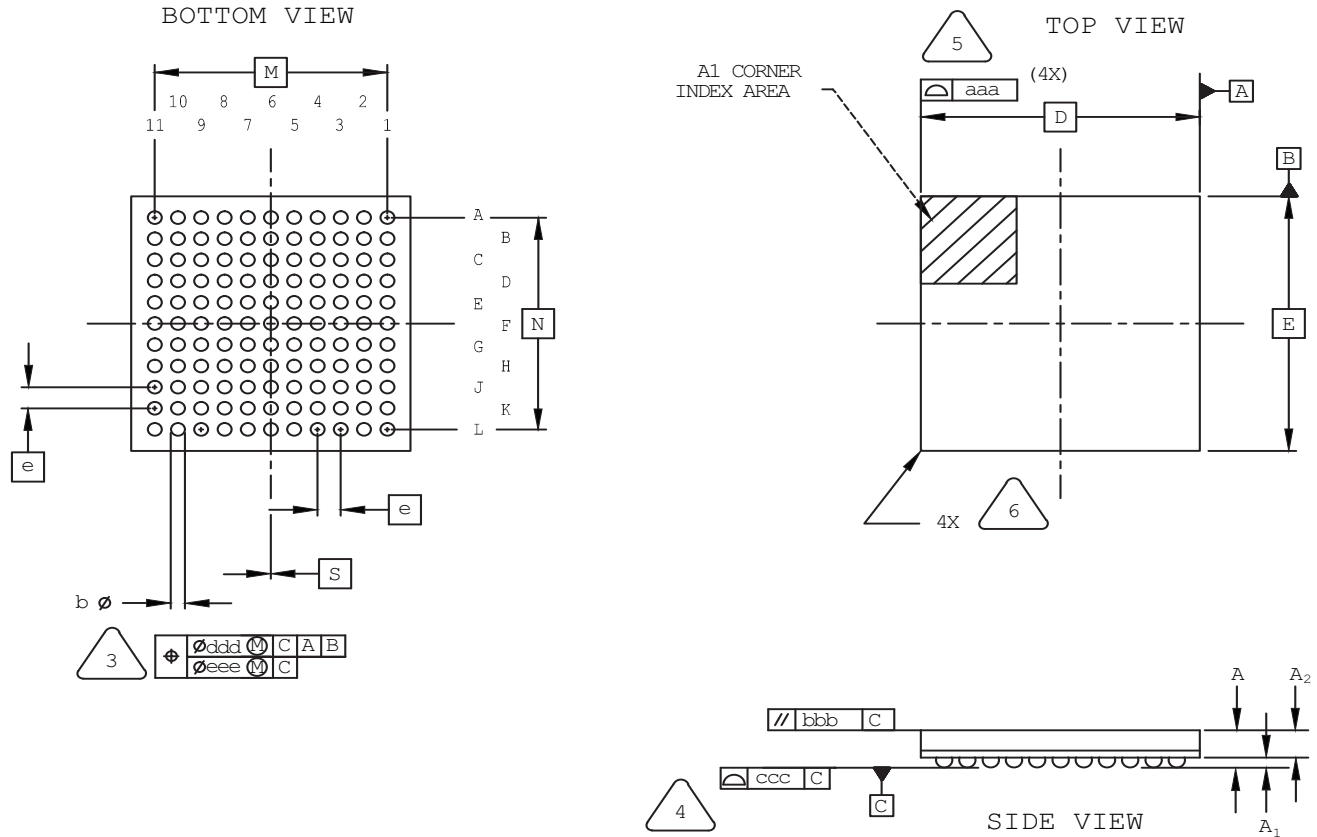

NOTES: UNLESS OTHERWISE SPECIFIED

1. DIMENSIONS AND TOLERANCES PER ANSI Y14.5M.
2. ALL DIMENSIONS ARE IN MILLIMETERS.



DIMENSION "b" IS MEASURED AT THE MAXIMUM SOLDER BALL DIAMETER, PARALLEL TO PRIMARY DATUM [C].



PRIMARY DATUM [C] AND SEATING PLANE ARE DEFINED BY THE SPHERICAL CROWNS OF THE SOLDER BALLS.



BILATERAL TOLERANCE ZONE IS APPLIED TO EACH SIDE OF THE PACKAGE BODY.



EXACT SHAPE AND SIZE OF THIS FEATURE IS OPTIONAL.

SYMBOL	MIN.	NOM.	MAX.
A	-	-	1.00
A1	0.15	0.24	-
A2	-	0.66	-
D/E	6.00 BSC		
M/N	5.00 BSC		
S	0.00 BSC		
b	0.25	0.30	0.35
e	0.50 BSC		
aaa	0.10		
bbb	0.10		
ccc	0.08		
ddd	0.15		
eee	0.05		

121-Ball ucBGA Package

Dimensions in Millimeters

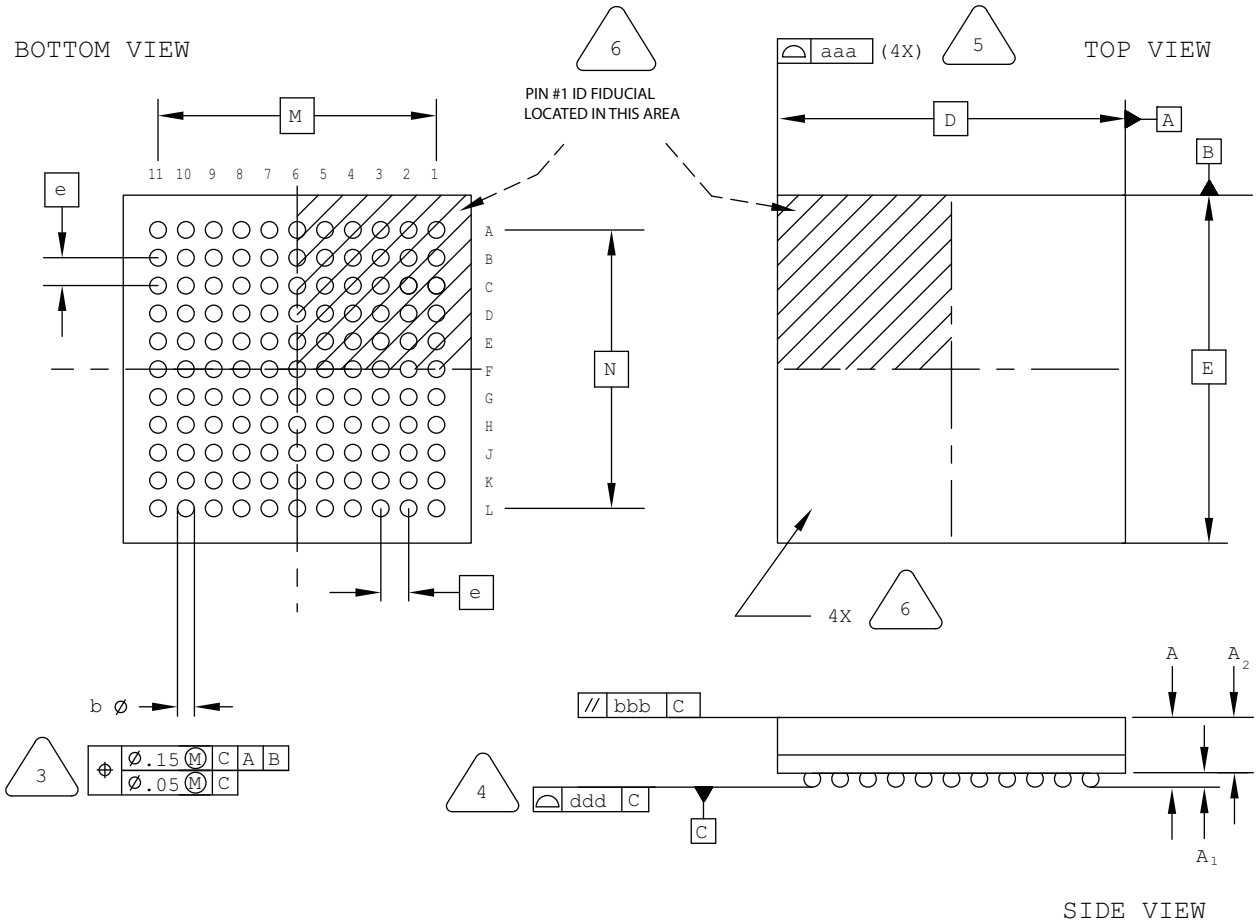

NOTES: UNLESS OTHERWISE SPECIFIED

- DIMENSIONS AND TOLERANCES PER ANSI Y14.5M.
- ALL DIMENSIONS ARE IN MILLIMETERS.

3 DIMENSION "b" IS MEASURED AT THE MAXIMUM SOLDER BALL DIAMETER, PARALLEL TO PRIMARY DATUM [C]

4 PRIMARY DATUM [C] AND SEATING PLANE ARE DEFINED BY THE SPHERICAL CROWNS OF THE SOLDER BALLS.

5 BILATERAL TOLERANCE ZONE IS APPLIED TO EACH SIDE OF THE PACKAGE BODY.

6 EXACT SHAPE AND SIZE OF THIS FEATURE IS OPTIONAL.

SYMBOL	MIN.	NOM.	MAX.
A	-	-	1.00
A1	0.10	-	-
A2	-	-	0.90
D/E	5.00 BSC		
M/N	4.00 BSC		
b	0.20	0.25	0.30
e	0.40 BSC		
aaa	-	-	0.10
bbb	-	-	0.10
ddd	-	-	0.10

128-Pin PQFP Package

Dimensions in Millimeters

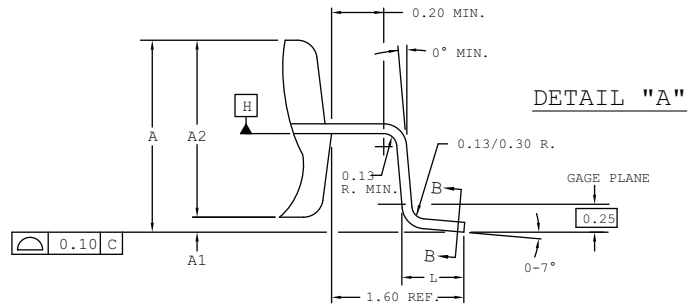
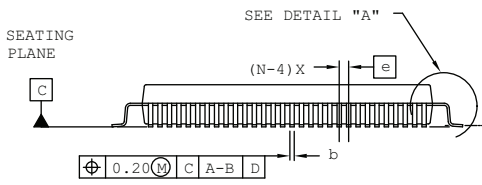
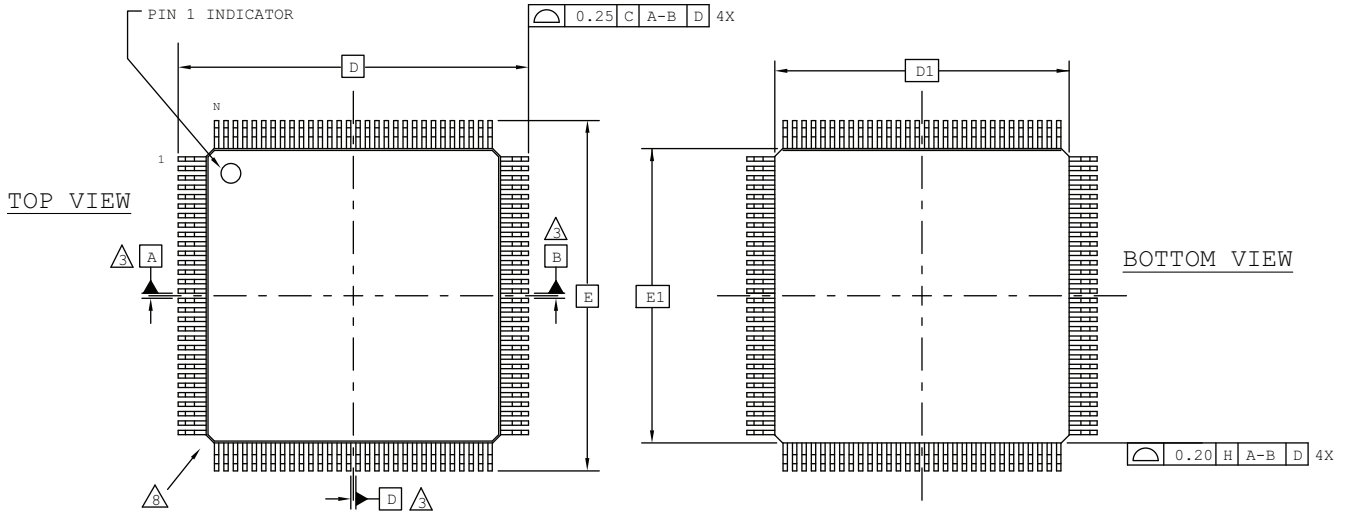

SECTION B - B

DETAIL "A"

NOTES:

- 1.0 DIMENSIONING AND TOLERANCING PER ANSI Y14.5 - 1982.
- 2.0 ALL DIMENSIONS ARE IN MILLIMETERS.
- 3.0 DATUMS A, B AND D TO BE DETERMINED AT DATUM PLANE H.
- 4.0 DIMENSIONS D1 AND E1 DO NOT INCLUDE MOLD PROTRUSION. ALLOWABLE MOLD PROTRUSION IS 0.254 MM ON D1 AND E1 DIMENSIONS.
- 5.0 THE TOP OF PACKAGE MAY BE SMALLER THAN THE BOTTOM OF THE PACKAGE BY 0.15 MM.
- 6.0 SECTION B-B:
THESE DIMENSIONS APPLY TO THE FLAT SECTION OF THE LEAD BETWEEN 0.10 AND 0.25 MM FROM THE LEAD TIP.
- 7.0 A1 IS DEFINED AS THE DISTANCE FROM THE SEATING PLANE TO THE LOWEST POINT ON THE PACKAGE BODY.
- 8.0 EXACT SHAPE OF EACH CORNER IS OPTIONAL.
- 9.0 EXACT SHAPE OF EXPOSED HEATSINK IS OPTIONAL.

SYMBOL	MIN.	NOM.	MAX.
A	-	-	4.10
A1	0.25	-	0.50
A2	3.20	3.40	3.60
D	31.20 BSC		
D1	28.00 BSC		
E	31.20 BSC		
E1	28.00 BSC		
L	0.73	0.88	1.03
N	128		
e	0.80 BSC		
b	0.29	-	0.45
b1	0.29	0.35	0.41
c	0.11	-	0.23
c1	0.11	0.15	0.19

128-Pin TQFP Package

Dimensions in Millimeters

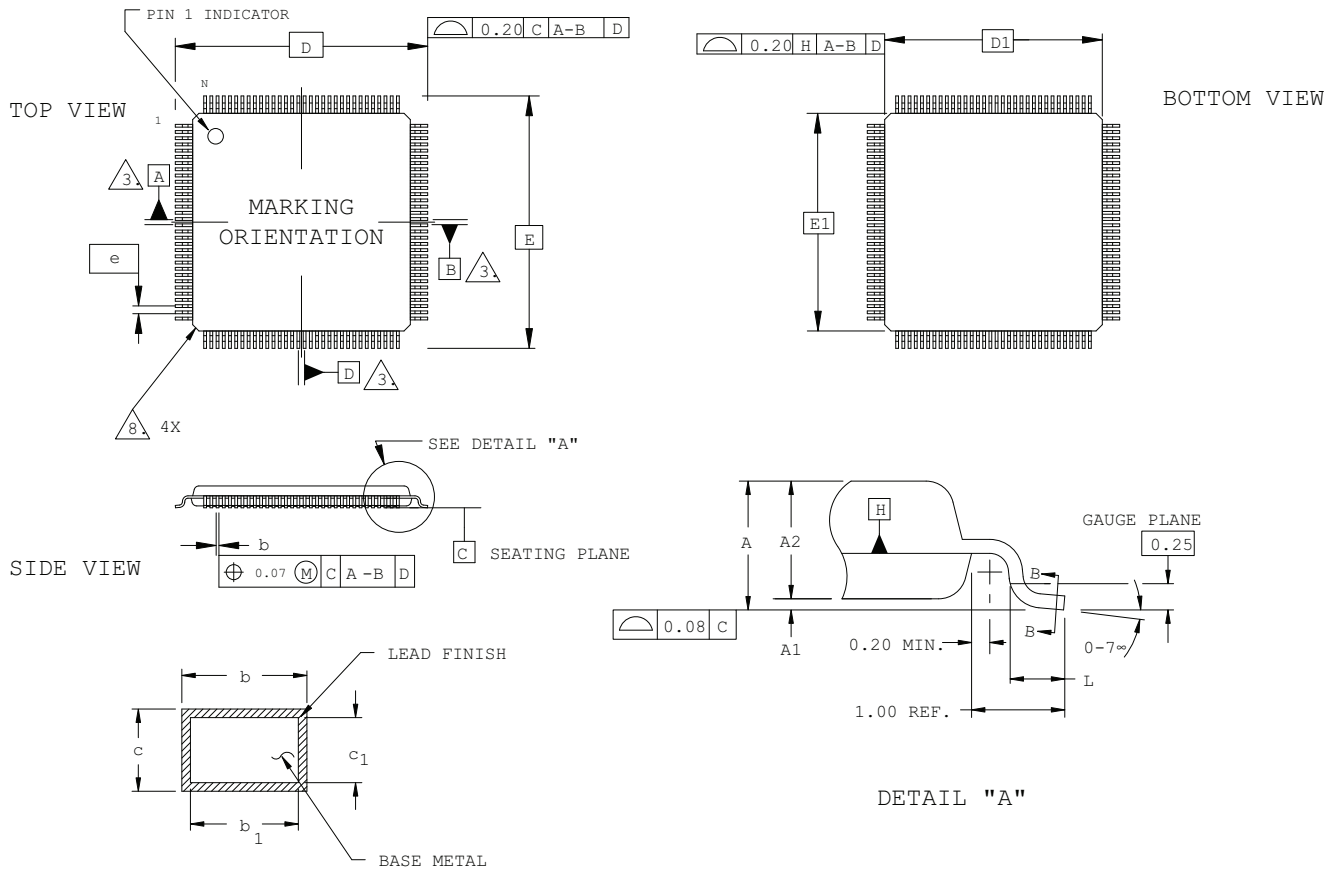

SECTION B - B

SIDE VIEW

NOTES:

- DIMENSIONING AND TOLERANCING PER ANSI Y14.5 - 1982.
- ALL DIMENSIONS ARE IN MILLIMETERS.
- DATUMS A, B AND D TO BE DETERMINED AT DATUM PLANE H.
- DIMENSIONS D1 AND E1 DO NOT INCLUDE MOLD PROTRUSION. ALLOWABLE MOLD PROTRUSION IS 0.254 MM ON D1 AND E1 DIMENSIONS.
- THE TOP OF PACKAGE MAY BE SMALLER THAN THE BOTTOM OF THE PACKAGE BY 0.15 MM.
- SECTION B-B:
THESE DIMENSIONS APPLY TO THE FLAT SECTION OF THE LEAD BETWEEN 0.10 AND 0.25 MM FROM THE LEAD TIP.
- A1 IS DEFINED AS THE DISTANCE FROM THE SEATING PLANE TO THE LOWEST POINT ON THE PACKAGE BODY.
- EXACT SHAPE OF EACH CORNER IS OPTIONAL.

SYMBOL	MIN.	NOM.	MAX.
A	-	-	1.60
A1	0.05	-	0.15
A2	1.35	1.40	1.45
D	16.00 BSC		
D1	14.00 BSC		
E	16.00 BSC		
E1	14.00 BSC		
L	0.45	0.60	0.75
N	128		
e	0.40 BSC		
b	0.13	0.18	0.23
b1	0.13	0.16	0.19
c	0.09	0.15	0.20
c1	0.09	0.13	0.16

132-Ball csBGA Package Option 1: MachXO2, MachXO, LatticeXP2™

Dimensions in Millimeters

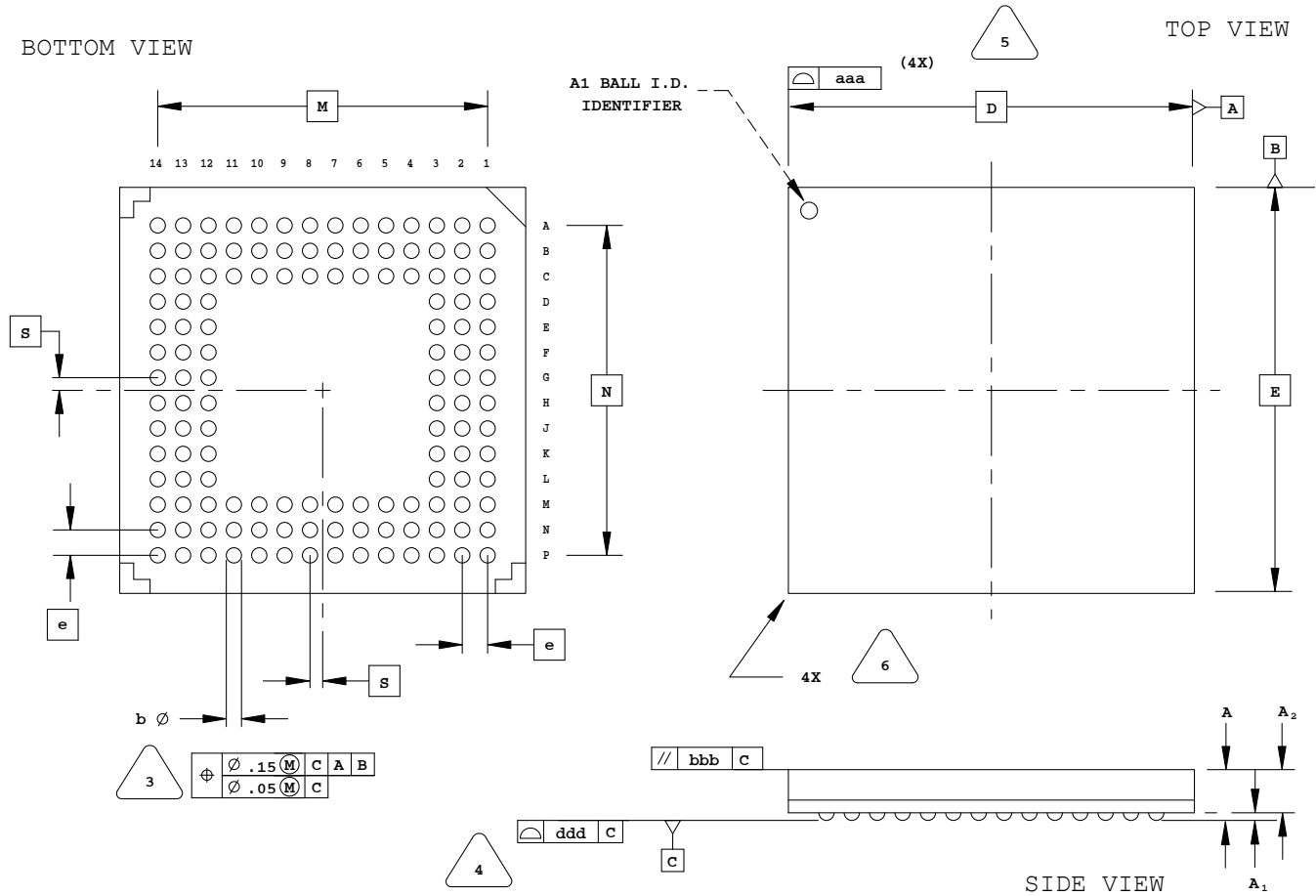

NOTES: UNLESS OTHERWISE SPECIFIED

- DIMENSIONS AND TOLERANCES PER ANSI Y14.5M.
- ALL DIMENSIONS ARE IN MILLIMETERS.



DIMENSION "b" IS MEASURED AT THE MAXIMUM SOLDER BALL DIAMETER, PARALLEL TO PRIMARY DATUM **C**



PRIMARY DATUM **C** AND SEATING PLANE ARE DEFINED BY THE SPHERICAL CROWNS OF THE SOLDER BALLS.



BILATERAL TOLERANCE ZONE IS APPLIED TO EACH SIDE OF THE PACKAGE BODY.



EXACT SHAPE AND SIZE OF THIS FEATURE IS OPTIONAL.

SYMBOL	MIN.	NOM.	MAX.
A	0.90	1.23	1.35
A1	0.15	-	-
A2	-	-	1.10
D/E	8.00 BSC		
M/N	6.50 BSC		
s	0.25 BSC		
b	0.25	0.30	0.35
e	0.50 BSC		
aaa	-	-	0.10
bbb	-	-	0.10
ddd	-	-	0.08

132-Ball csBGA Package Option 2: iCE40

Dimensions in Millimeters

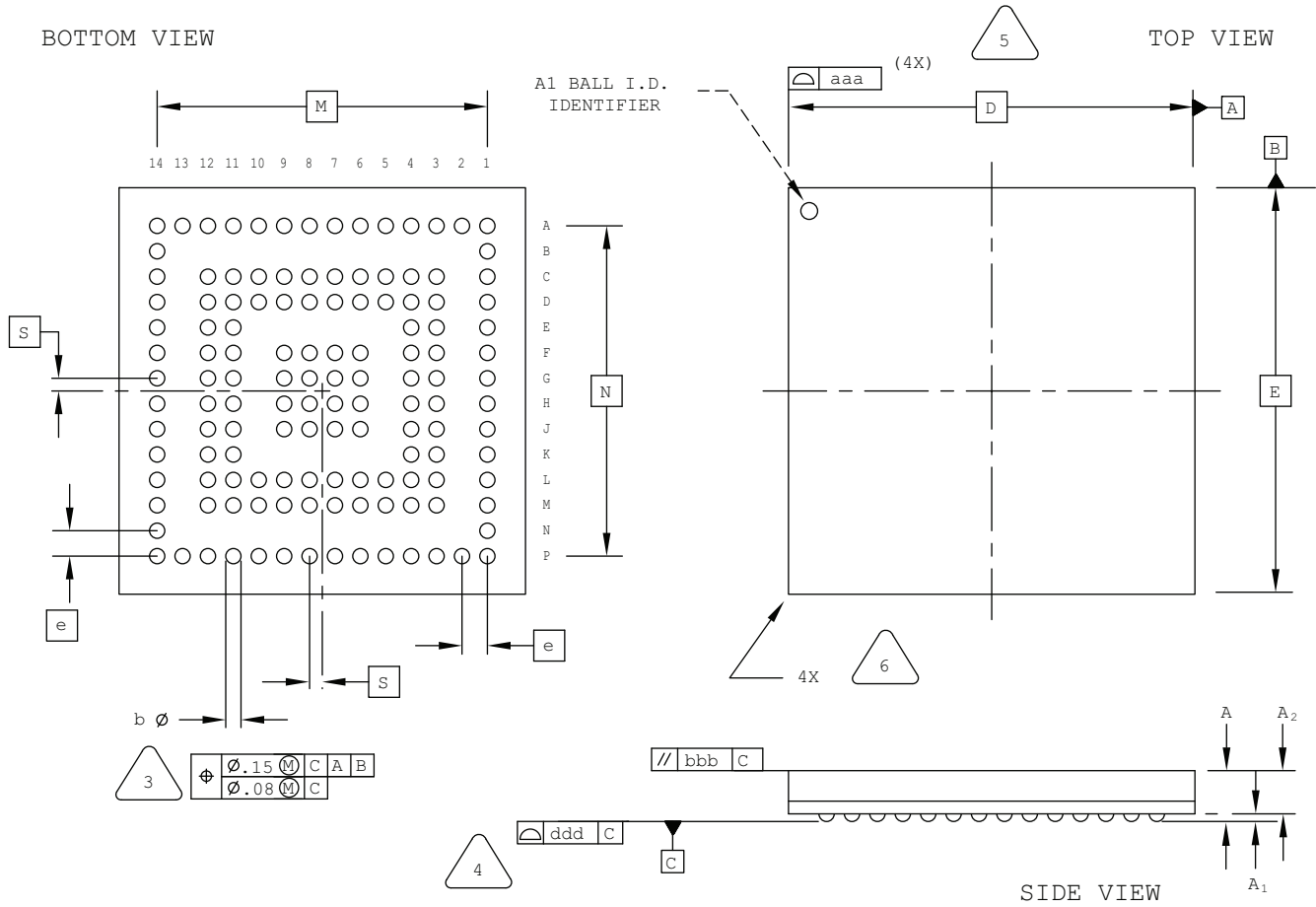

NOTES: UNLESS OTHERWISE SPECIFIED

1. DIMENSIONS AND TOLERANCES PER ANSI Y14.5M.
2. ALL DIMENSIONS ARE IN MILLIMETERS.



DIMENSION "b" IS MEASURED AT THE MAXIMUM SOLDER BALL DIAMETER, PARALLEL TO PRIMARY DATUM C



PRIMARY DATUM C AND SEATING PLANE ARE DEFINED BY THE SPHERICAL CROWNS OF THE SOLDER BALLS.



BILATERAL TOLERANCE ZONE IS APPLIED TO EACH SIDE OF THE PACKAGE BODY.



EXACT SHAPE AND SIZE OF THIS FEATURE IS OPTIONAL.

SYMBOL	MIN.	NOM.	MAX.
A	-	-	1.00
A1	0.15	-	-
A2	-	-	0.85
D/E	8.00 BSC		
M/N	6.50 BSC		
S	0.25 BSC		
b	0.25	0.30	0.35
e	0.50 BSC		
aaa	-	-	0.10
bbb	-	-	0.10
ddd	-	-	0.08

132-Ball ucBGA Package

Dimensions in Millimeters

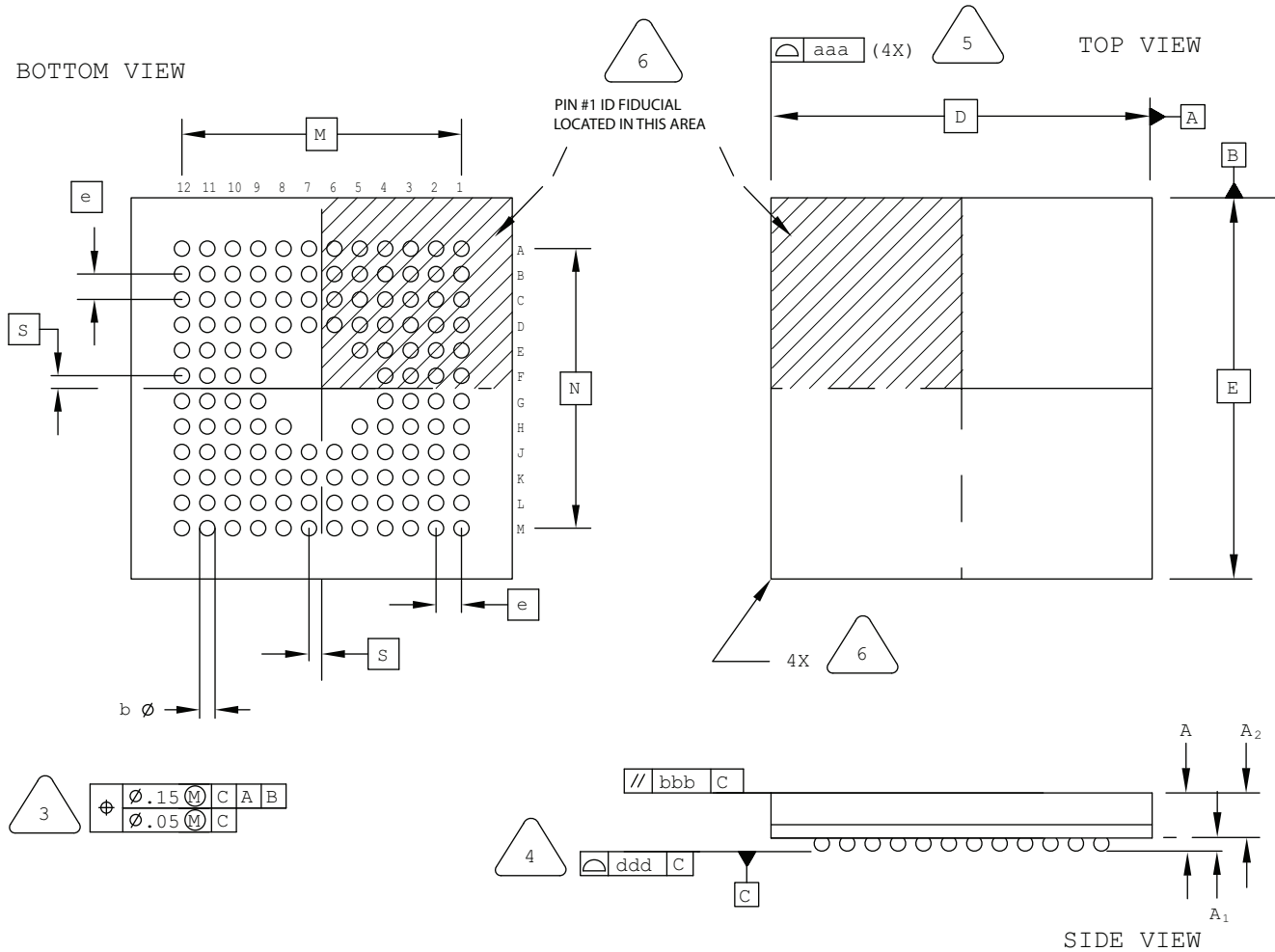

NOTES: UNLESS OTHERWISE SPECIFIED

- DIMENSIONS AND TOLERANCES PER ANSI Y14.5M.
- ALL DIMENSIONS ARE IN MILLIMETERS.



DIMENSION "b" IS MEASURED AT THE MAXIMUM SOLDER BALL DIAMETER, PARALLEL TO PRIMARY DATUM **C**



PRIMARY DATUM **C** AND SEATING PLANE ARE DEFINED BY THE SPHERICAL CROWNS OF THE SOLDER BALLS.



BILATERAL TOLERANCE ZONE IS APPLIED TO EACH SIDE OF THE PACKAGE BODY.



EXACT SHAPE AND SIZE OF THIS FEATURE IS OPTIONAL.

SYMBOL	MIN.	NOM.	MAX.
A	-	-	1.00
A1	0.10	-	-
A2	-	-	0.90
D/E	6.00 BSC		
M/N	4.40 BSC		
s	0.20 BSC		
b	0.20	0.25	0.30
e	0.40 BSC		
aaa	-	-	0.10
bbb	-	-	0.10
ddd	-	-	0.08

133-Pin CPGA Package

Dimensions in Inches

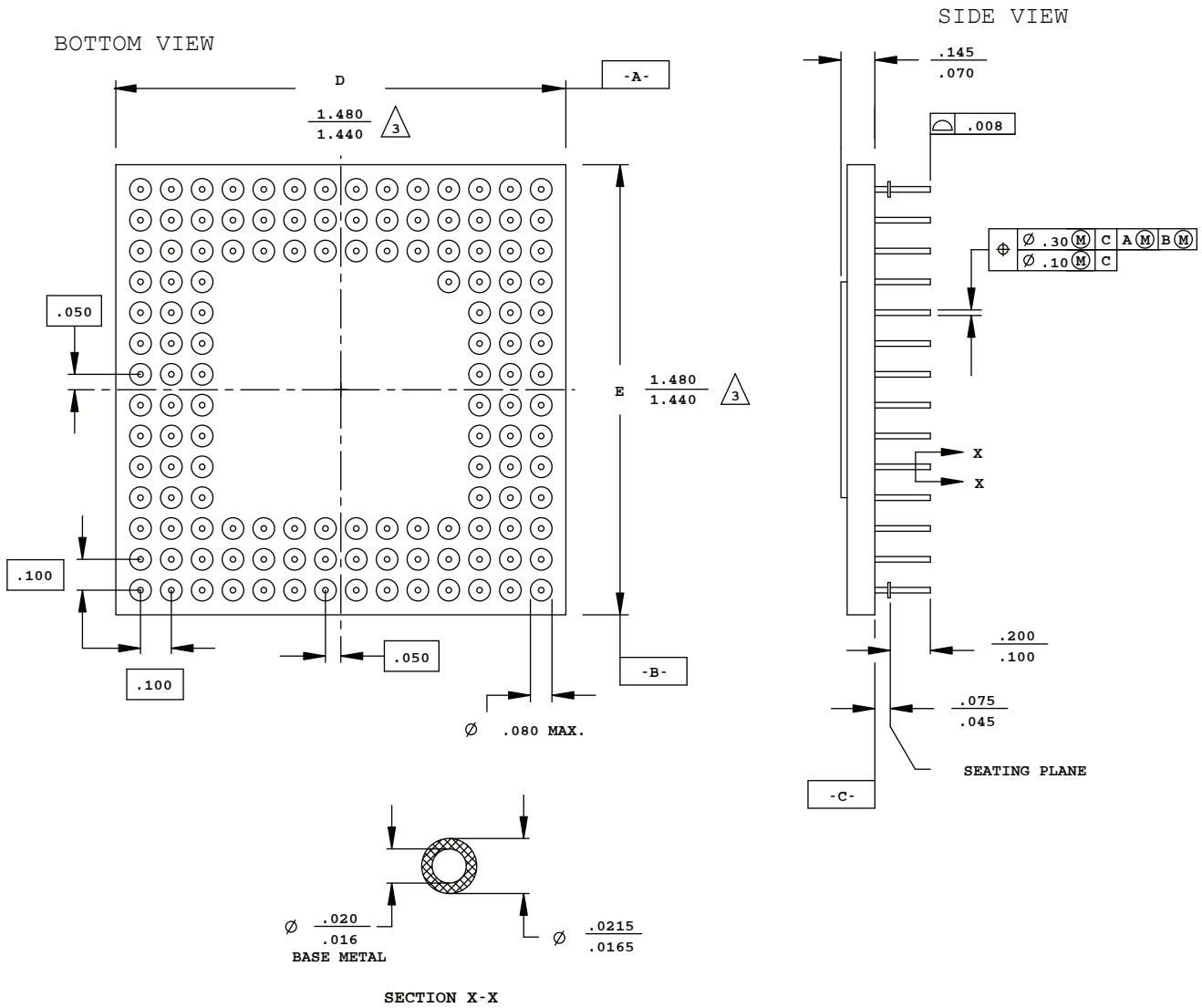

NOTES :

1. DIMENSIONING AND TOLERANCING PER ANSI Y14.5M.
2. ALL DIMENSIONS ARE IN INCHES.



DIMENSIONS D AND E MAY HAVE MATERIAL PROTRUSION OF .006 INCHES MAXIMUM ABOVE THE DIMENSION SHOWN NOT TO EXCEED .003 INCHES MAXIMUM PER SIDE.

144-Ball csBGA Package

Dimensions in Millimeters

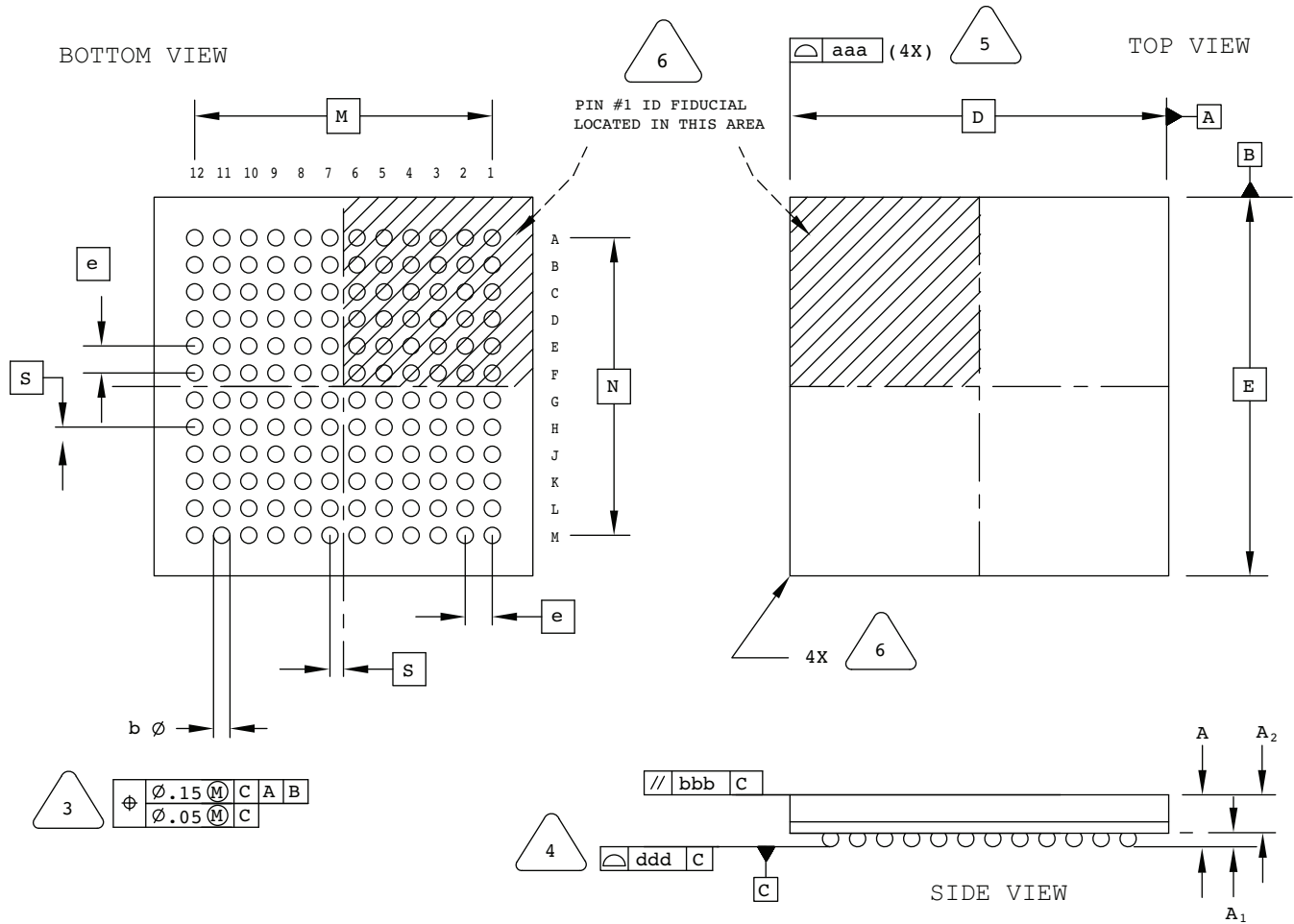

NOTES: UNLESS OTHERWISE SPECIFIED

- DIMENSIONS AND TOLERANCES PER ANSI Y14.5M.
- ALL DIMENSIONS ARE IN MILLIMETERS.

3 DIMENSION "b" IS MEASURED AT THE MAXIMUM SOLDER BALL DIAMETER, PARALLEL TO PRIMARY DATUM [C]

4 PRIMARY DATUM [C] AND SEATING PLANE ARE DEFINED BY THE SPHERICAL CROWNS OF THE SOLDER BALLS.

5 BILATERAL TOLERANCE ZONE IS APPLIED TO EACH SIDE OF THE PACKAGE BODY.

6 EXACT SHAPE AND SIZE OF THIS FEATURE IS OPTIONAL.

SYMBOL	MIN.	NOM.	MAX.
A	0.90	1.00	1.10
A1	0.15	-	-
A2	-	-	0.85
D/E	7.00 BSC		
M/N	5.50 BSC		
S	0.25 BSC		
b	0.25	0.30	0.35
e	0.50 BSC		
aaa	-	-	0.10
bbb	-	-	0.10
ddd	-	-	0.08

144-Ball fpBGA Package

Dimensions in Millimeters

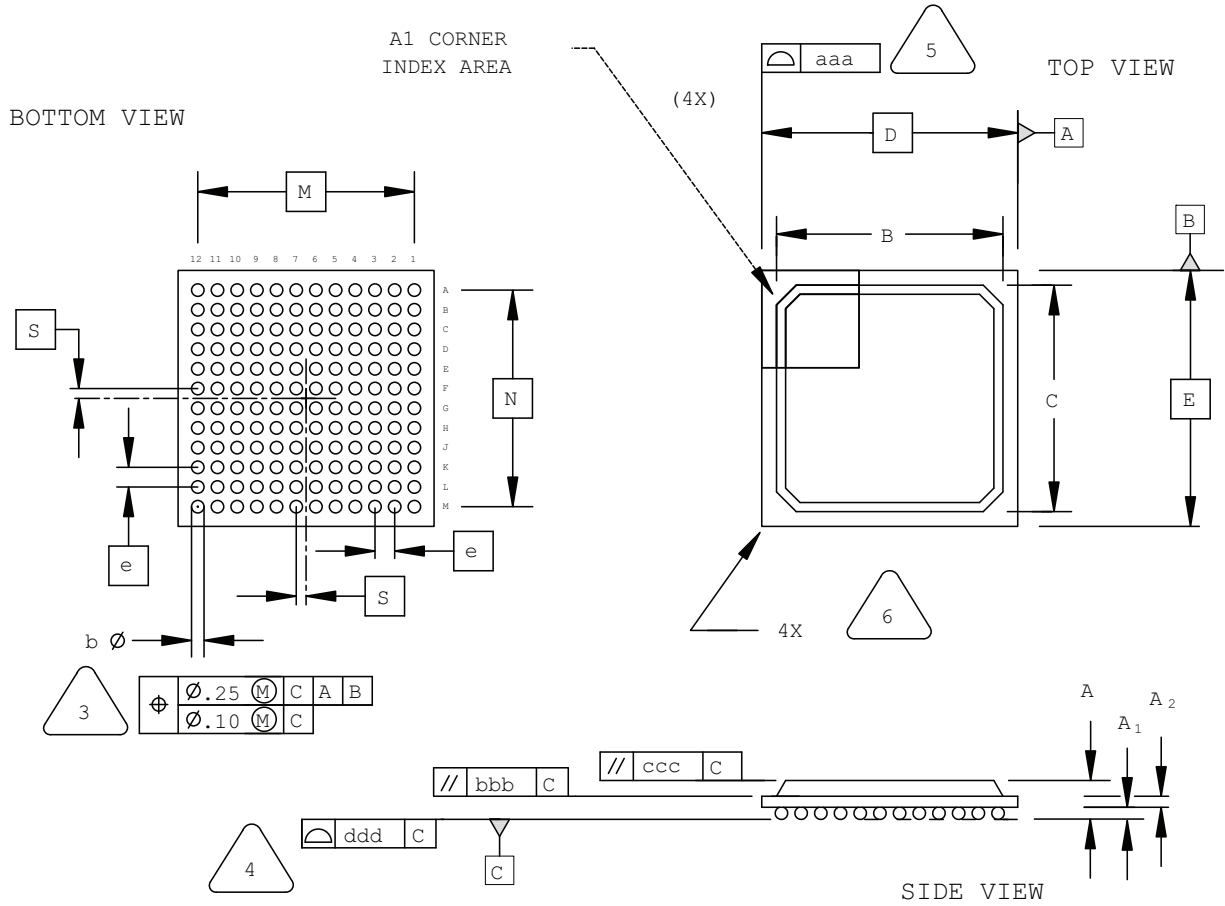

NOTES: UNLESS OTHERWISE SPECIFIED

1. DIMENSIONS AND TOLERANCES PER ANSI Y14.5M.
2. ALL DIMENSIONS ARE IN MILLIMETERS.

3. DIMENSION "b" IS MEASURED AT THE MAXIMUM SOLDER BALL DIAMETER, PARALLEL TO PRIMARY DATUM $\square C$

4. PRIMARY DATUM $\square C$ AND SEATING PLANE ARE DEFINED BY THE SPHERICAL CROWNS OF THE SOLDER BALLS.

5. BILATERAL TOLERANCE ZONE IS APPLIED TO EACH SIDE OF THE PACKAGE BODY.

6. EXACT SHAPE AND SIZE OF THIS FEATURE IS OPTIONAL.

SYMBOL	MIN.	NOM.	MAX.
A	1.30	1.70	2.10
A1	0.30	0.50	0.70
A2	0.30	0.50	0.70
B/C	11.00	11.60	12.20
D/E	13.00 BSC		
M/N	11.00 BSC		
S	0.50 BSC		
b	0.50	0.60	0.70
e	1.00 BSC		
aaa	-	-	0.20
bbb	-	-	0.25
ccc	-	-	0.35
ddd	-	-	0.20

144-Pin TQFP Package

Dimensions in Millimeters

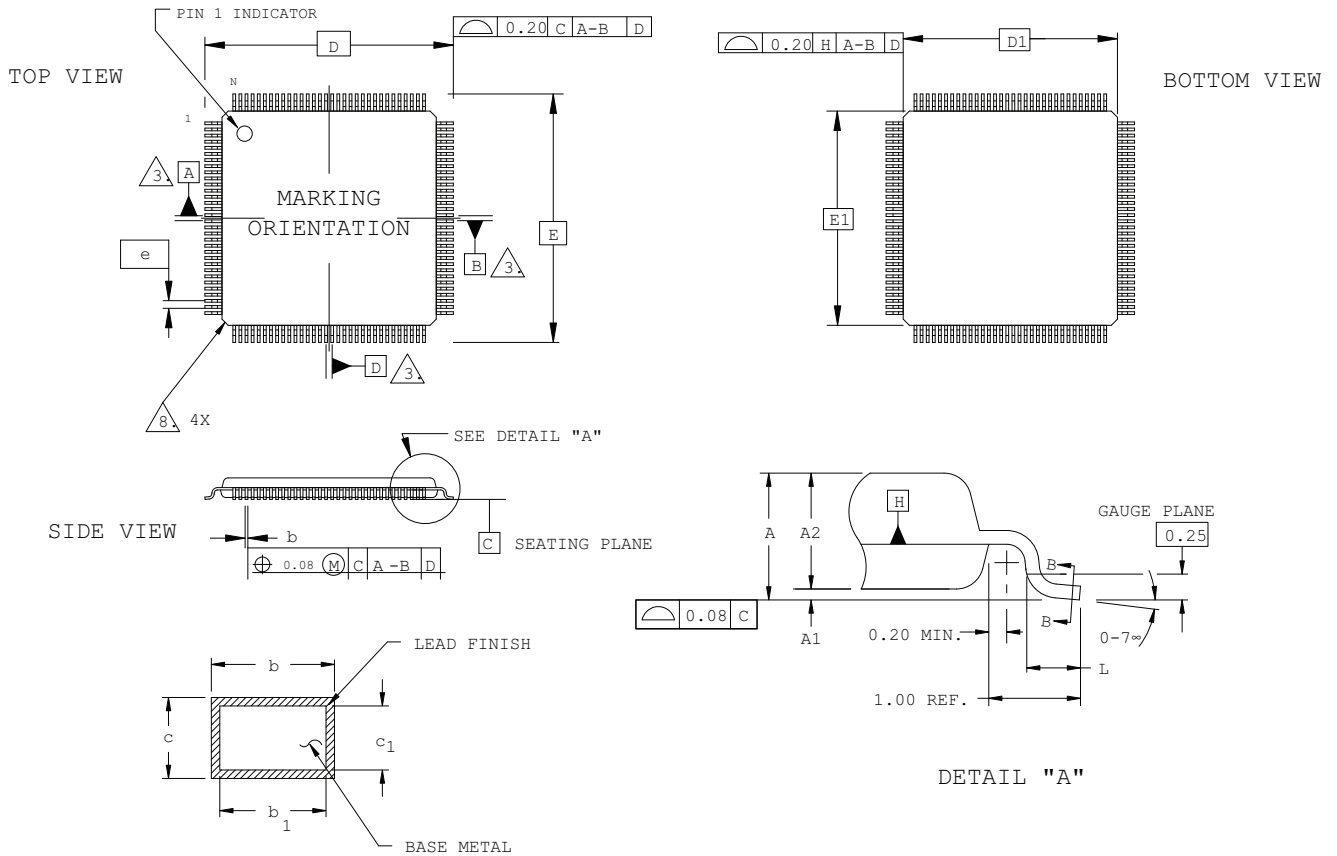

SECTION B - B

NOTES:

- DIMENSIONING AND TOLERANCING PER ANSI Y14.5 - 1982.
- ALL DIMENSIONS ARE IN MILLIMETERS.
- DATUMS A, B AND D TO BE DETERMINED AT DATUM PLANE H.
- DIMENSIONS D1 AND E1 DO NOT INCLUDE MOLD PROTRUSION. ALLOWABLE MOLD PROTRUSION IS 0.254 MM ON D1 AND E1 DIMENSIONS.
- THE TOP OF PACKAGE MAY BE SMALLER THAN THE BOTTOM OF THE PACKAGE BY 0.15 MM.
- SECTION B-B:
THESE DIMENSIONS APPLY TO THE FLAT SECTION OF THE LEAD BETWEEN 0.10 AND 0.25 MM FROM THE LEAD TIP.
- A1 IS DEFINED AS THE DISTANCE FROM THE SEATING PLANE TO THE LOWEST POINT ON THE PACKAGE BODY.
- EXACT SHAPE OF EACH CORNER IS OPTIONAL.

SYMBOL	MIN.	NOM.	MAX.
A	-	-	1.60
A1	0.05	-	0.15
A2	1.35	1.40	1.45
D	22.00 BSC		
D1	20.00 BSC		
E	22.00 BSC		
E1	20.00 BSC		
L	0.45	0.60	0.75
N	144		
e	0.50 BSC		
b	0.17	0.22	0.27
b1	0.17	0.20	0.23
c	0.09	0.15	0.20
c1	0.09	0.13	0.16

160-Pin PQFP Package

Dimensions in Millimeters

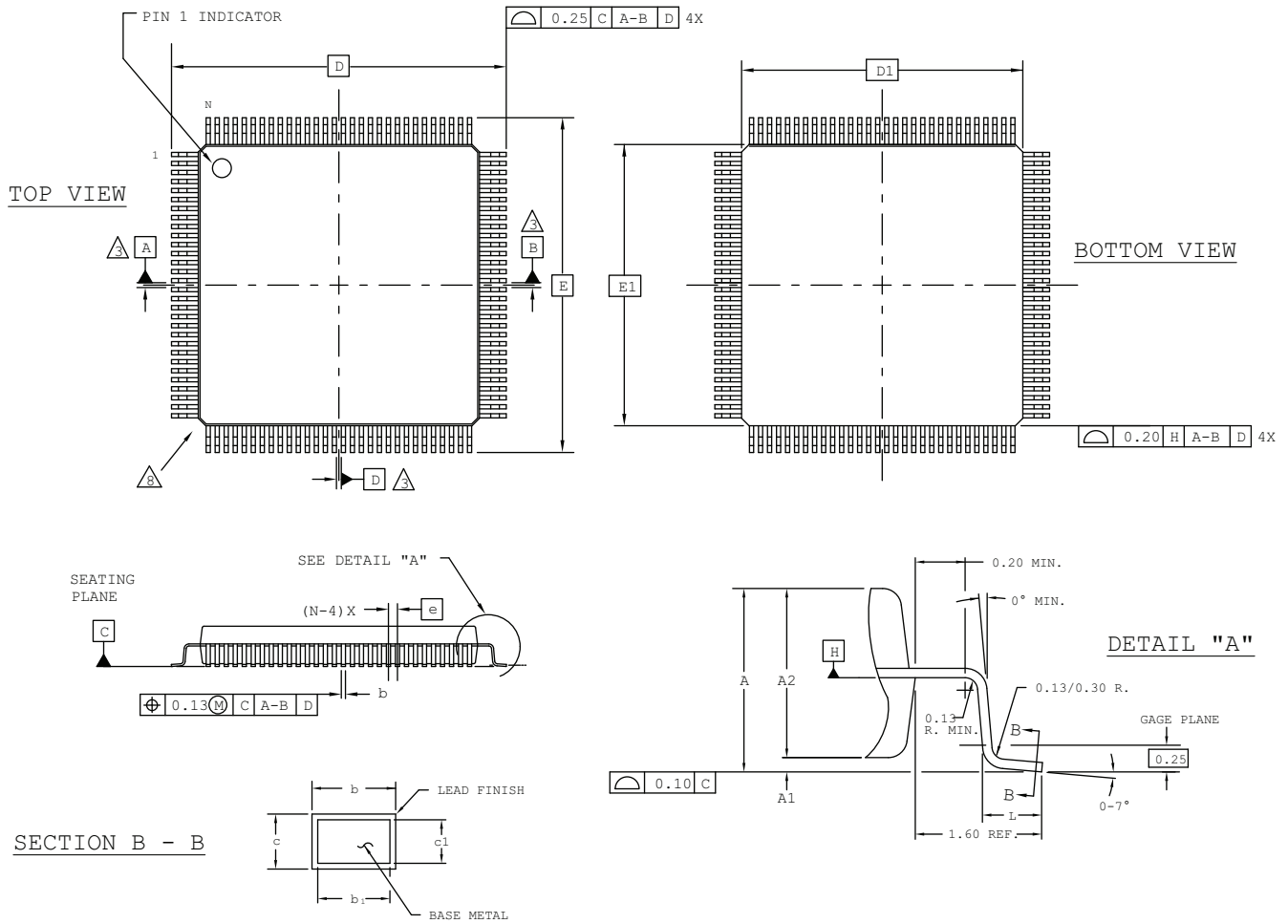

NOTES:

- 1.0 DIMENSIONING AND TOLERANCING PER ANSI Y14.5 - 1982.
 - 2.0 ALL DIMENSIONS ARE IN MILLIMETERS.
 - 3.0 DATUMS A, B AND D TO BE DETERMINED AT DATUM PLANE H.
 - 4.0 DIMENSIONS D1 AND E1 DO NOT INCLUDE MOLD PROTRUSION. ALLOWABLE MOLD PROTRUSION IS 0.254 MM ON D1 AND E1 DIMENSIONS.
 - 5.0 THE TOP OF PACKAGE MAY BE SMALLER THAN THE BOTTOM OF THE PACKAGE BY 0.15 MM.
 - 6.0 SECTION B-B:
THESE DIMENSIONS APPLY TO THE FLAT SECTION OF THE LEAD BETWEEN 0.10 AND 0.25 MM FROM THE LEAD TIP.
 - 7.0 A1 IS DEFINED AS THE DISTANCE FROM THE SEATING PLANE TO THE LOWEST POINT ON THE PACKAGE BODY.
- 8.0 EXACT SHAPE OF EACH CORNER IS OPTIONAL.
- 9.0 EXACT SHAPE OF EXPOSED HEATSINK IS OPTIONAL.

SYMBOL	MIN.	NOM.	MAX.
A	-	-	4.10
A1	0.25	-	0.50
A2	3.20	3.40	3.60
D	31.20 BSC		
D1	28.00 BSC		
E	31.20 BSC		
E1	28.00 BSC		
L	0.73	0.88	1.03
N	160		
e	0.65 BSC		
b	0.22	-	0.40
b1	0.22	0.30	0.36
c	0.11	-	0.23
c1	0.11	0.15	0.19

176-Pin TQFP Package

Dimensions in Millimeters

TOP VIEW

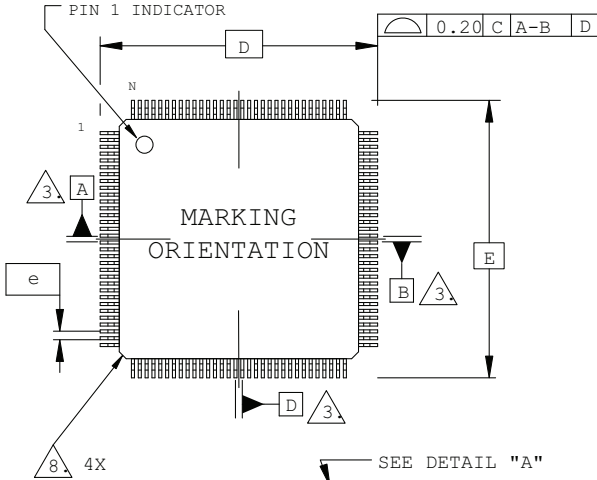

BOTTOM VIEW

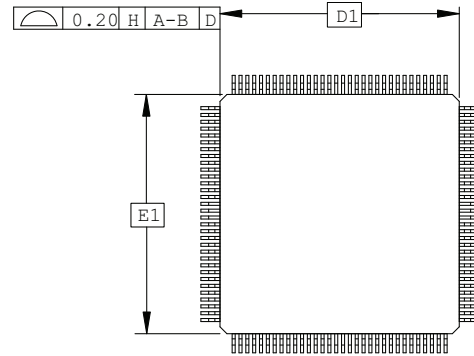

SIDE VIEW

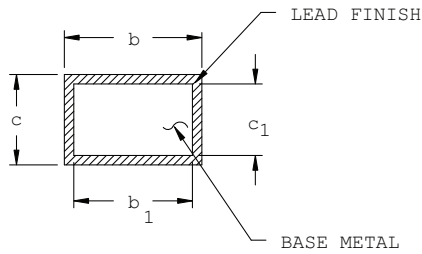
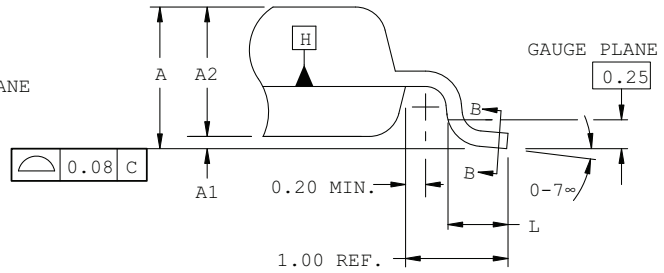
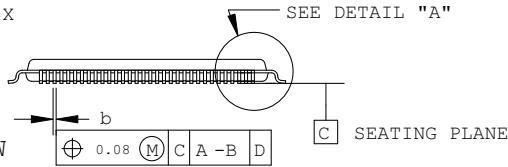

DETAIL "A"

SECTION B - B

NOTES:

- DIMENSIONING AND TOLERANCING PER ANSI Y14.5 - 1982.
- ALL DIMENSIONS ARE IN MILLIMETERS.
- DATUMS A, B AND D TO BE DETERMINED AT DATUM PLANE H.
- DIMENSIONS D1 AND E1 DO NOT INCLUDE MOLD PROTRUSION. ALLOWABLE MOLD PROTRUSION IS 0.254 MM ON D1 AND E1 DIMENSIONS.
- THE TOP OF PACKAGE MAY BE SMALLER THAN THE BOTTOM OF THE PACKAGE BY 0.15 MM.
- SECTION B-B:
THESE DIMENSIONS APPLY TO THE FLAT SECTION OF THE LEAD BETWEEN 0.10 AND 0.25 MM FROM THE LEAD TIP.
- A1 IS DEFINED AS THE DISTANCE FROM THE SEATING PLANE TO THE LOWEST POINT ON THE PACKAGE BODY.
- EXACT SHAPE OF EACH CORNER IS OPTIONAL.

SYMBOL	MIN.	NOM.	MAX.
A	-	-	1.60
A1	0.05	-	0.15
A2	1.35	1.40	1.45
D	26.00 BSC		
D1	24.00 BSC		
E	26.00 BSC		
E1	24.00 BSC		
L	0.45	0.60	0.75
N	176		
e	0.50 BSC		
b	0.17	0.22	0.27
b1	0.17	0.20	0.23
c	0.09	0.15	0.20
c1	0.09	0.13	0.16

184-Ball csBGA Package

Dimensions in Millimeters

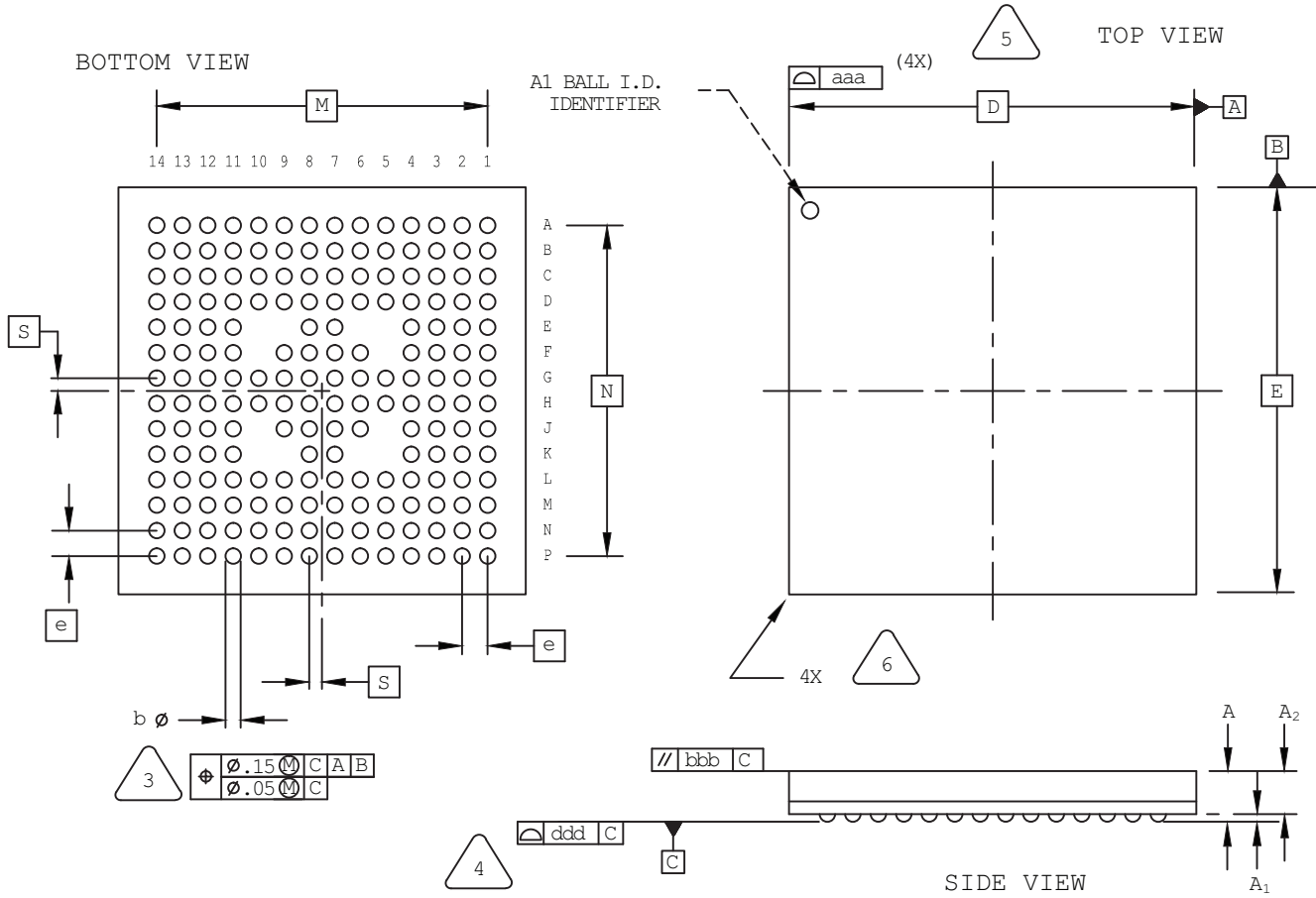

NOTES: UNLESS OTHERWISE SPECIFIED

1. DIMENSIONS AND TOLERANCES PER ANSI Y14.5M.
2. ALL DIMENSIONS ARE IN MILLIMETERS.



DIMENSION "b" IS MEASURED AT THE MAXIMUM SOLDER BALL DIAMETER, PARALLEL TO PRIMARY DATUM C



PRIMARY DATUM C AND SEATING PLANE ARE DEFINED BY THE SPHERICAL CROWNS OF THE SOLDER BALLS.



BILATERAL TOLERANCE ZONE IS APPLIED TO EACH SIDE OF THE PACKAGE BODY.



EXACT SHAPE AND SIZE OF THIS FEATURE IS OPTIONAL.

SYMBOL	MIN.	NOM.	MAX.
A	1.20	1.35	1.50
A1	0.16	-	-
A2	-	-	1.34
D/E	8.00 BSC		
M/N	6.50 BSC		
S	0.25 BSC		
b	0.25	0.30	0.35
e	0.50 BSC		
aaa	-	-	0.10
bbb	-	-	0.10
ddd	-	-	0.08

196-Ball csBGA Package

Dimensions in Millimeters

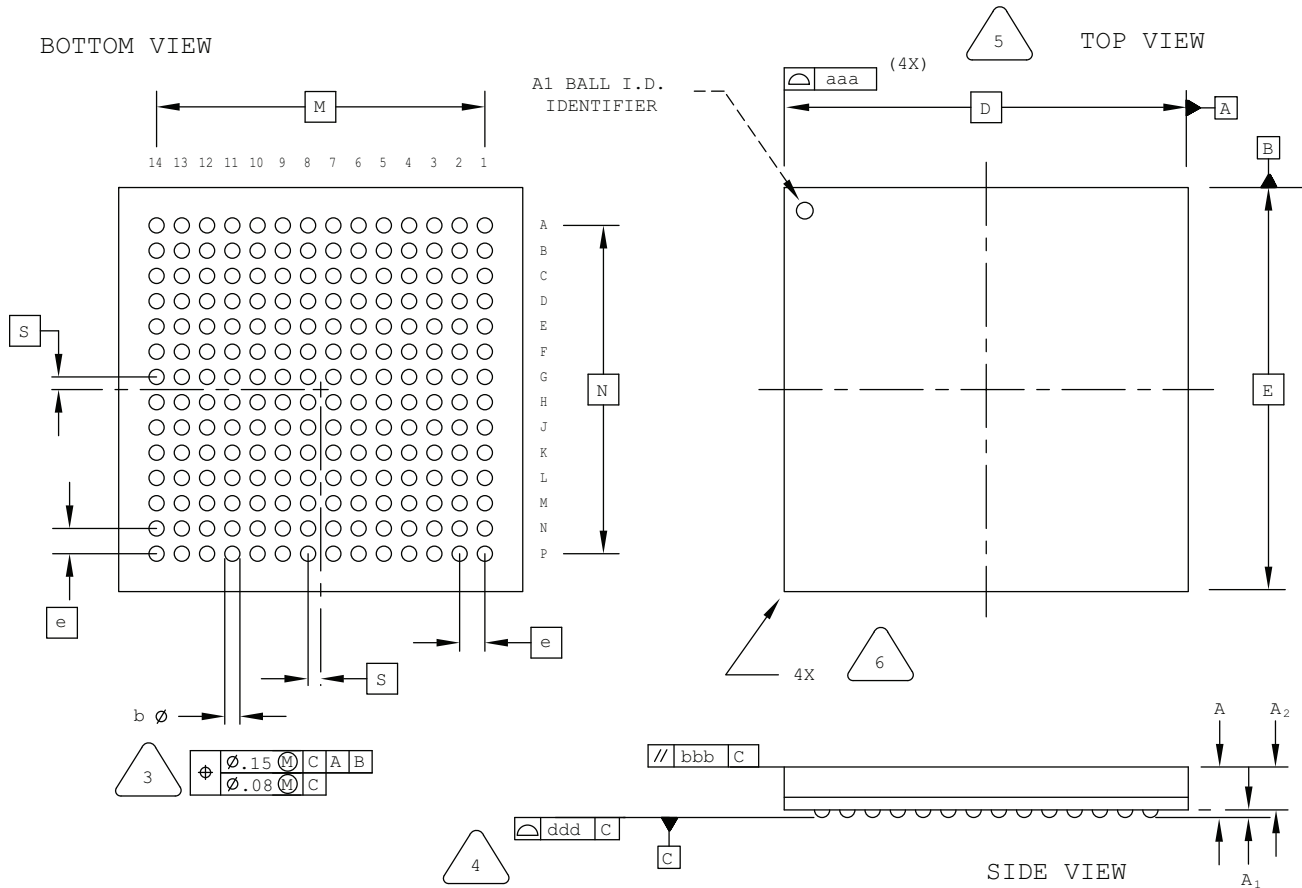

NOTES: UNLESS OTHERWISE SPECIFIED

- DIMENSIONS AND TOLERANCES PER ANSI Y14.5M.
- ALL DIMENSIONS ARE IN MILLIMETERS.



DIMENSION "b" IS MEASURED AT THE MAXIMUM SOLDER BALL DIAMETER, PARALLEL TO PRIMARY DATUM [C]



PRIMARY DATUM [C] AND SEATING PLANE ARE DEFINED BY THE SPHERICAL CROWNS OF THE SOLDER BALLS.



BILATERAL TOLERANCE ZONE IS APPLIED TO EACH SIDE OF THE PACKAGE BODY.



EXACT SHAPE AND SIZE OF THIS FEATURE IS OPTIONAL.

SYMBOL	MIN.	NOM.	MAX.
A	-	-	1.00
A1	0.15	-	-
A2	-	-	0.85
D/E	8.00 BSC		
M/N	6.50 BSC		
S	0.25 BSC		
b	0.25	0.30	0.35
e	0.50 BSC		
aaa	-	-	0.10
bbb	-	-	0.10
ddd	-	-	0.08

208-Ball ftBGA Package

Dimensions in Millimeters

BOTTOM VIEW

TOP VIEW

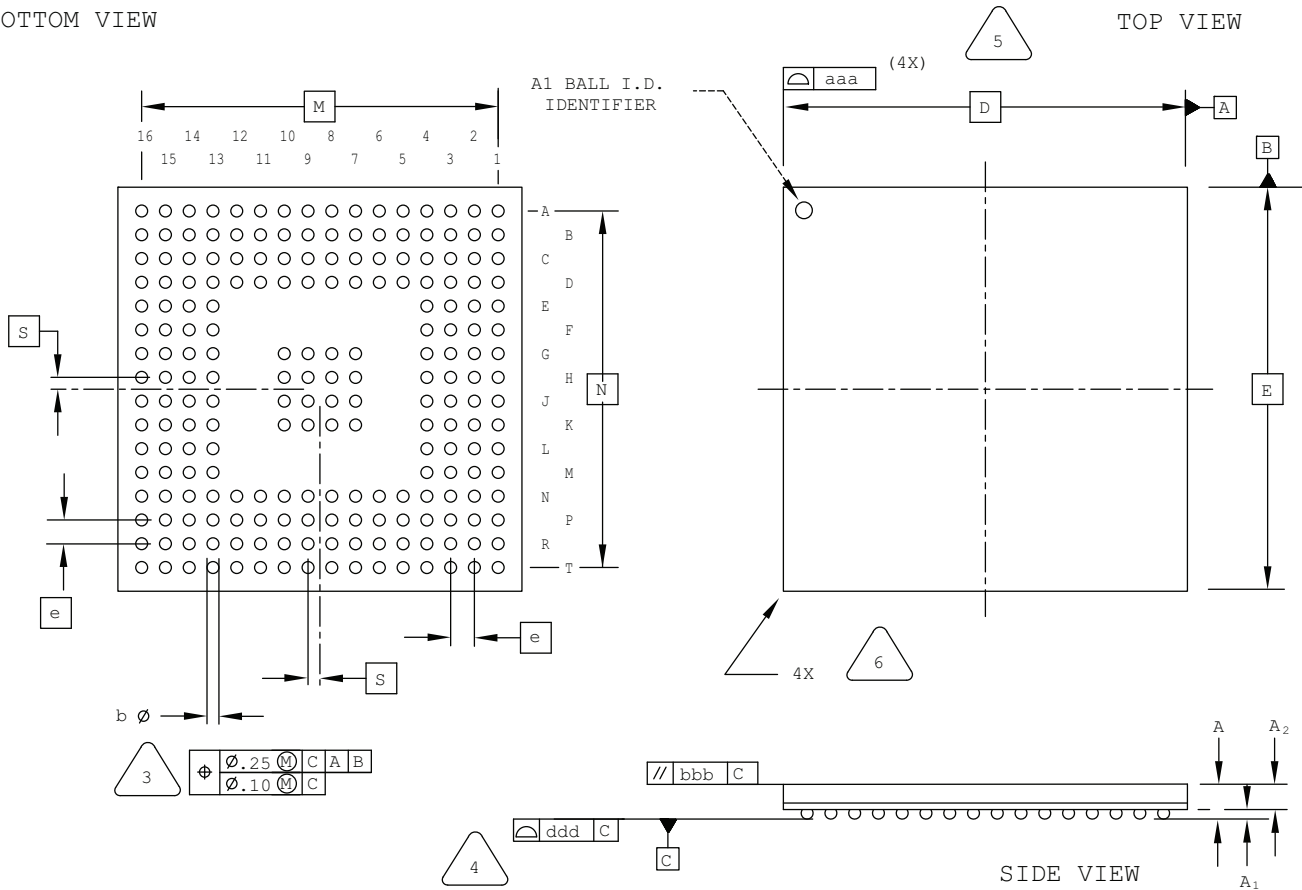

NOTES: UNLESS OTHERWISE SPECIFIED

1. DIMENSIONS AND TOLERANCES PER ANSI Y14.5M.
2. ALL DIMENSIONS ARE IN MILLIMETERS.



DIMENSION "b" IS MEASURED AT THE MAXIMUM SOLDER BALL DIAMETER, PARALLEL TO PRIMARY DATUM [C]



PRIMARY DATUM [C] AND SEATING PLANE ARE DEFINED BY THE SPHERICAL CROWNS OF THE SOLDER BALLS.



BILATERAL TOLERANCE ZONE IS APPLIED TO EACH SIDE OF THE PACKAGE BODY.



EXACT SHAPE AND SIZE OF THIS FEATURE IS OPTIONAL.

SYMBOL	MIN.	NOM.	MAX.
A	1.25	1.40	1.55
A1	0.30	-	-
A2	-	-	1.25
D/E	17.0 BSC		
M/N	15.0 BSC		
S	0.50 BSC		
b	0.40	0.50	0.60
e	1.0 BSC		
aaa	-	-	0.20
bbb	-	-	0.25
ddd	-	-	0.12

208-Ball fpBGA Package

Dimensions in Millimeters

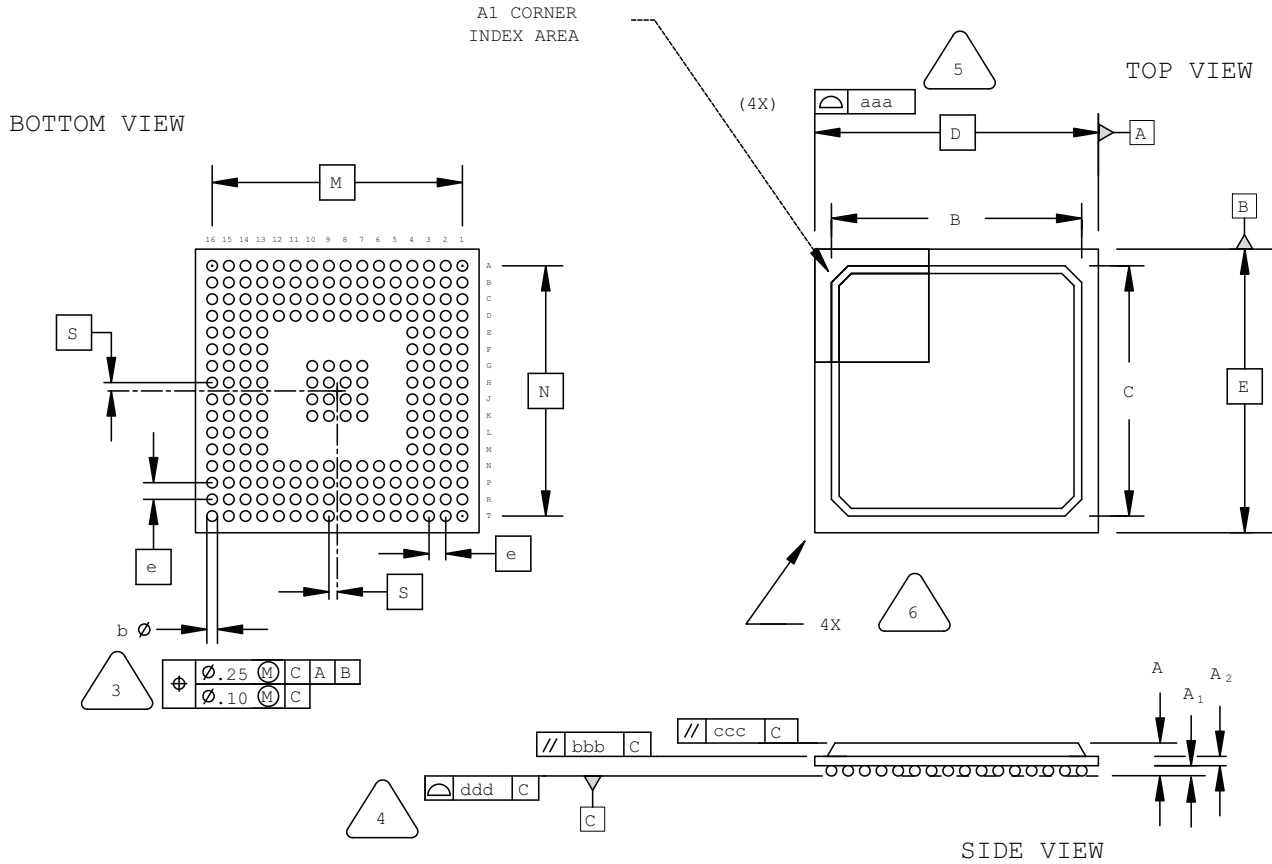

NOTES: UNLESS OTHERWISE SPECIFIED

1. DIMENSIONS AND TOLERANCES PER ANSI Y14.5M.
2. ALL DIMENSIONS ARE IN MILLIMETERS.



DIMENSION "b" IS MEASURED AT THE MAXIMUM SOLDER BALL DIAMETER, PARALLEL TO PRIMARY DATUM [C]



PRIMARY DATUM [C] AND SEATING PLANE ARE DEFINED BY THE SPHERICAL CROWNS OF THE SOLDER BALLS.



BILATERAL TOLERANCE ZONE IS APPLIED TO EACH SIDE OF THE PACKAGE BODY.



EXACT SHAPE AND SIZE OF THIS FEATURE IS OPTIONAL.

SYMBOL	MIN.	NOM.	MAX.
A	1.30	1.70	2.10
A1	0.30	0.50	0.70
A2	0.30	0.50	0.70
B/C	14.80	15.30	15.80
D/E	17.00 BSC		
M/N	15.00 BSC		
S	0.50 BSC		
b	0.50	0.60	0.70
e	1.00 BSC		
aaa	-	-	0.20
bbb	-	-	0.25
ccc	-	-	0.35
ddd	-	-	0.20

208-Pin PQFP Package

Dimensions in Millimeters

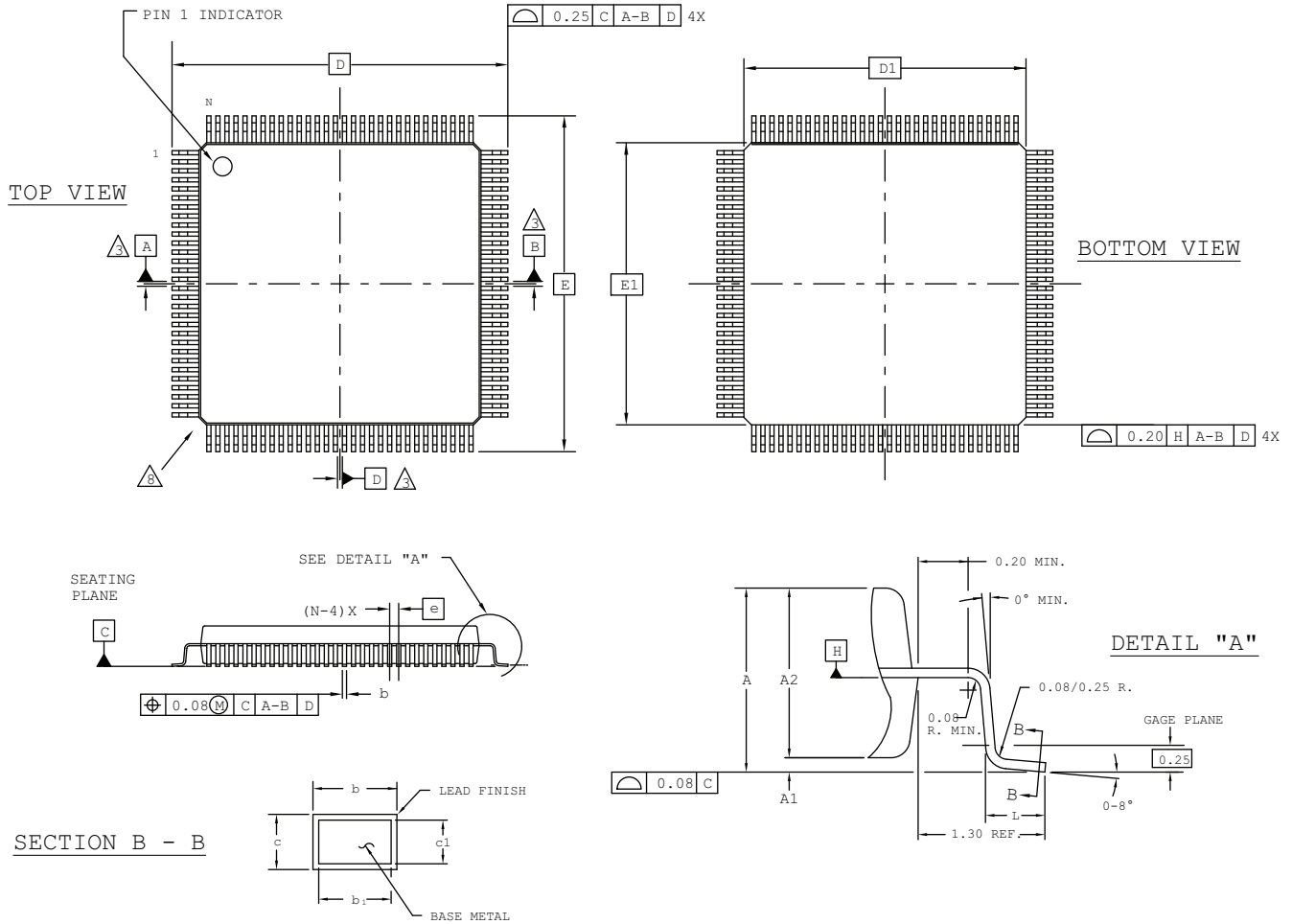

NOTES:

- 1.0 DIMENSIONING AND TOLERANCING PER ANSI Y14.5 - 1982.
- 2.0 ALL DIMENSIONS ARE IN MILLIMETERS.
- 3.0 DATUMS A, B AND D TO BE DETERMINED AT DATUM PLANE H.
- 4.0 DIMENSIONS D1 AND E1 DO NOT INCLUDE MOLD PROTRUSION. ALLOWABLE MOLD PROTRUSION IS 0.254 MM ON D1 AND E1 DIMENSIONS.
- 5.0 THE TOP OF PACKAGE MAY BE SMALLER THAN THE BOTTOM OF THE PACKAGE BY 0.15 MM.
- 6.0 SECTION B-B:
THESE DIMENSIONS APPLY TO THE FLAT SECTION OF THE LEAD BETWEEN 0.10 AND 0.25 MM FROM THE LEAD TIP.
- 7.0 A1 IS DEFINED AS THE DISTANCE FROM THE SEATING PLANE TO THE LOWEST POINT ON THE PACKAGE BODY.
- 8.0 EXACT SHAPE OF EACH CORNER IS OPTIONAL.
- 9.0 EXACT SHAPE OF EXPOSED HEATSINK IS OPTIONAL.

SYMBOL	MIN.	NOM.	MAX.
A	-	-	4.10
A1	0.25	-	0.50
A2	3.20	3.40	3.60
D	30.60 BSC		
D1	28.00 BSC		
E	30.60 BSC		
E1	28.00 BSC		
L	0.45	0.60	0.75
N	208		
e	0.50 BSC		
b	0.17	-	0.27
b1	0.17	0.20	0.23
c	0.09	-	0.20
c1	0.09	0.12	0.16

225-Ball ucBGA Package

Dimensions in Millimeters

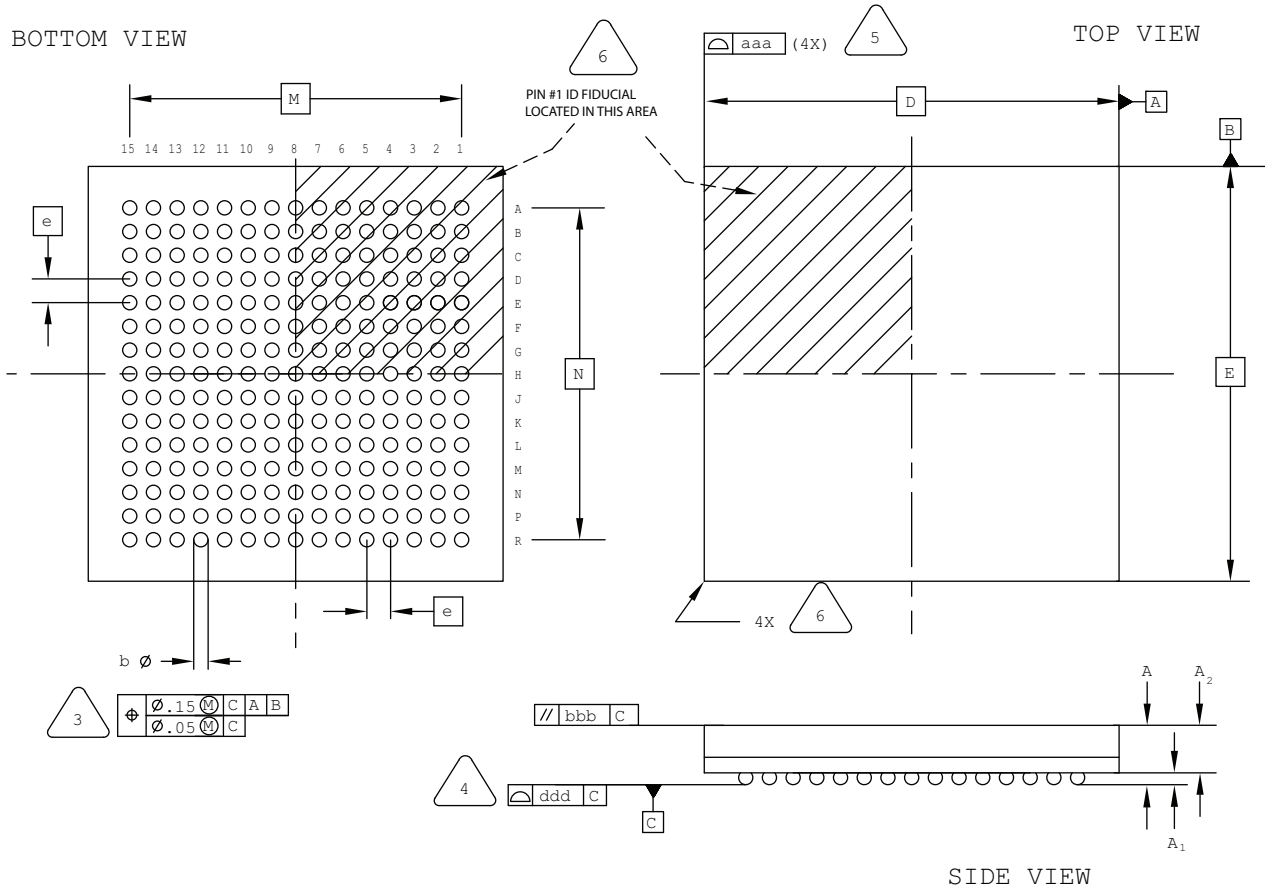

NOTES: UNLESS OTHERWISE SPECIFIED

1. DIMENSIONS AND TOLERANCES PER ANSI Y14.5M.
2. ALL DIMENSIONS ARE IN MILLIMETERS.

3 DIMENSION "b" IS MEASURED AT THE MAXIMUM SOLDER BALL DIAMETER, PARALLEL TO PRIMARY DATUM [C]

4 PRIMARY DATUM [C] AND SEATING PLANE ARE DEFINED BY THE SPHERICAL CROWNS OF THE SOLDER BALLS.

5 BILATERAL TOLERANCE ZONE IS APPLIED TO EACH SIDE OF THE PACKAGE BODY.

6 EXACT SHAPE AND SIZE OF THIS FEATURE IS OPTIONAL.

SYMBOL	MIN.	NOM.	MAX.
A	-	-	1.00
A1	0.10	-	-
A2	-	-	0.90
D/E	7.00 BSC		
M/N	5.60 BSC		
b	0.20	0.25	0.30
e	0.40 BSC		
aaa	-	-	0.10
bbb	-	-	0.10
ddd	-	-	0.10

237-Ball ftBGA Package

Dimensions in Millimeters

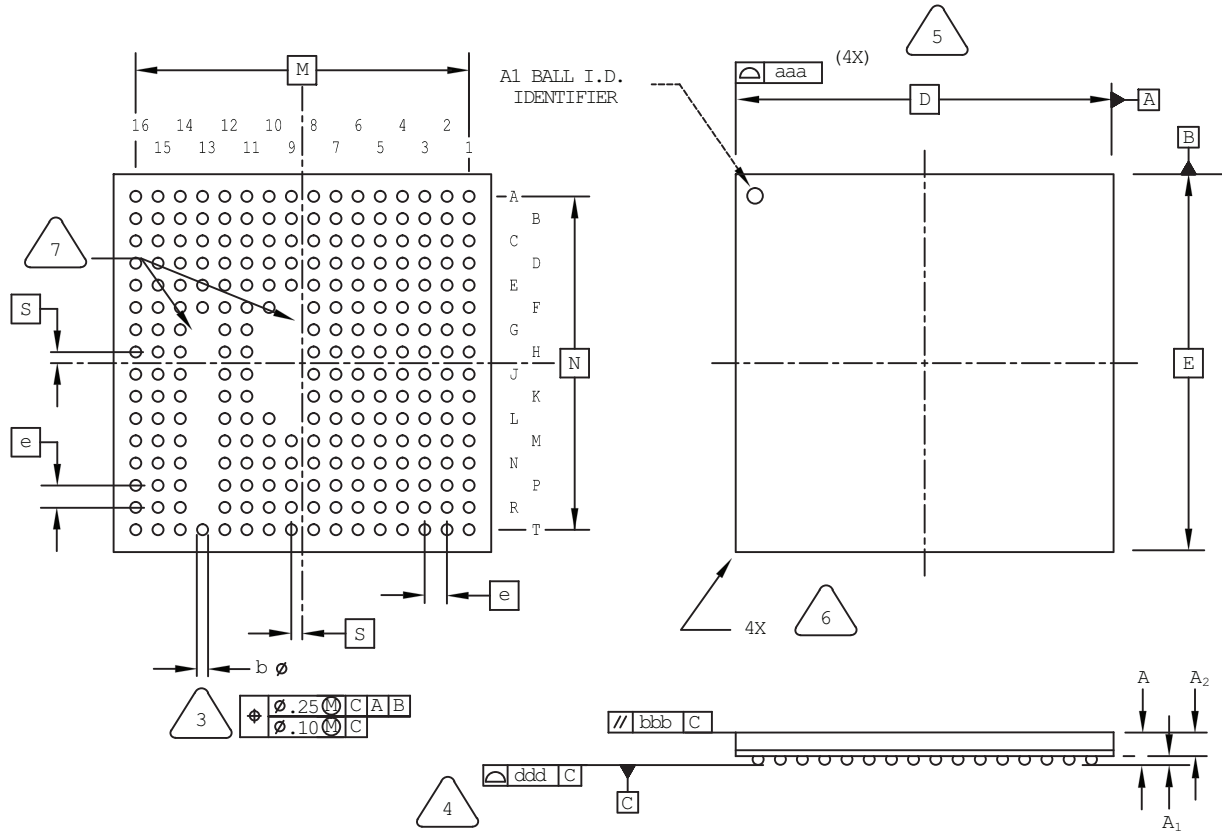

NOTES: UNLESS OTHERWISE SPECIFIED

1. DIMENSIONS AND TOLERANCES PER ANSI Y14.5M.
2. ALL DIMENSIONS ARE IN MILLIMETERS.



DIMENSION "b" IS MEASURED AT THE MAXIMUM SOLDER BALL DIAMETER, PARALLEL TO PRIMARY DATUM [C]



PRIMARY DATUM [C] AND SEATING PLANE ARE DEFINED BY THE SPHERICAL CROWNS OF THE SOLDER BALLS.



BILATERAL TOLERANCE ZONE IS APPLIED TO EACH SIDE OF THE PACKAGE BODY.



EXACT SHAPE AND SIZE OF THIS FEATURE IS OPTIONAL.



DEPOPULATED 13G TO 13R, 10G TO 10K, AND 9F TO 9L.

SYMBOL	MIN.	NOM.	MAX.
A	1.40	1.55	1.70
A1	0.30	-	-
A2	-	-	1.24
D/E	17.0 BSC		
M/N	15.0 BSC		
S	0.50 BSC		
b	0.40	0.50	0.60
e	1.0 BSC		
aaa	-	-	0.20
bbb	-	-	0.25
ddd	-	-	0.15

256-Ball caBGA Package

Dimensions in Millimeters

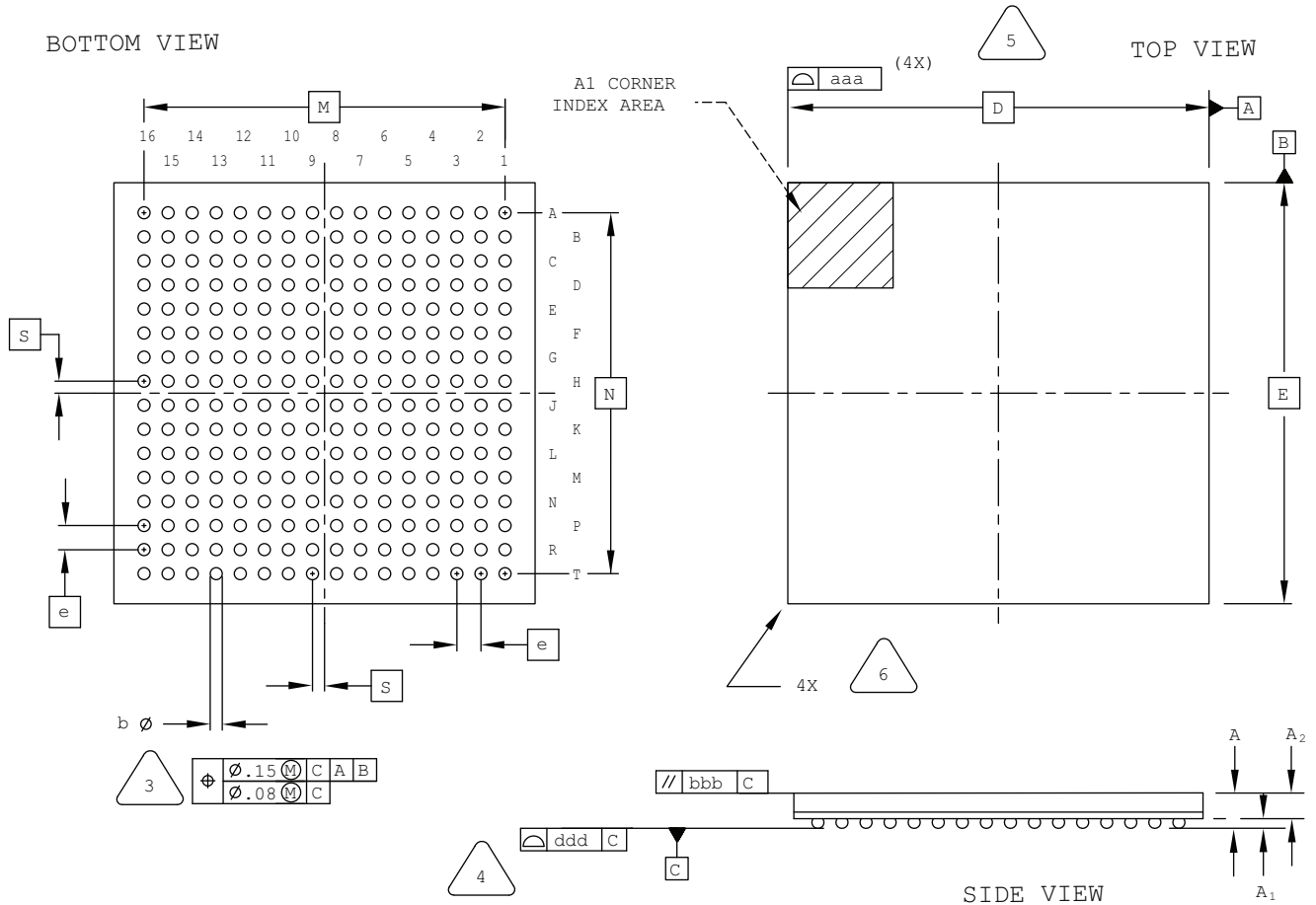

NOTES: UNLESS OTHERWISE SPECIFIED

1. DIMENSIONS AND TOLERANCES PER ANSI Y14.5M.
2. ALL DIMENSIONS ARE IN MILLIMETERS.

3. DIMENSION "b" IS MEASURED AT THE MAXIMUM SOLDER BALL DIAMETER, PARALLEL TO PRIMARY DATUM [C]

4. PRIMARY DATUM [C] AND SEATING PLANE ARE DEFINED BY THE SPHERICAL CROWNS OF THE SOLDER BALLS.

5. BILATERAL TOLERANCE ZONE IS APPLIED TO EACH SIDE OF THE PACKAGE BODY.

6. EXACT SHAPE AND SIZE OF THIS FEATURE IS OPTIONAL.

7. REFERENCE JEDEC MO-275, VARIATION JJAB-2.

SYMBOL	MIN.	NOM.	MAX.
A	-	-	1.70
A1	0.25	-	-
A2	0.65	-	-
D/E	14.0 BSC		
M/N	12.0 BSC		
S	0.40 BSC		
b	0.40	0.45	0.50
e	0.80 BSC		
aaa	-	-	0.15
bbb	-	-	0.20
ddd	-	-	0.20

256-Ball csfBGA Package

Dimensions in Millimeters

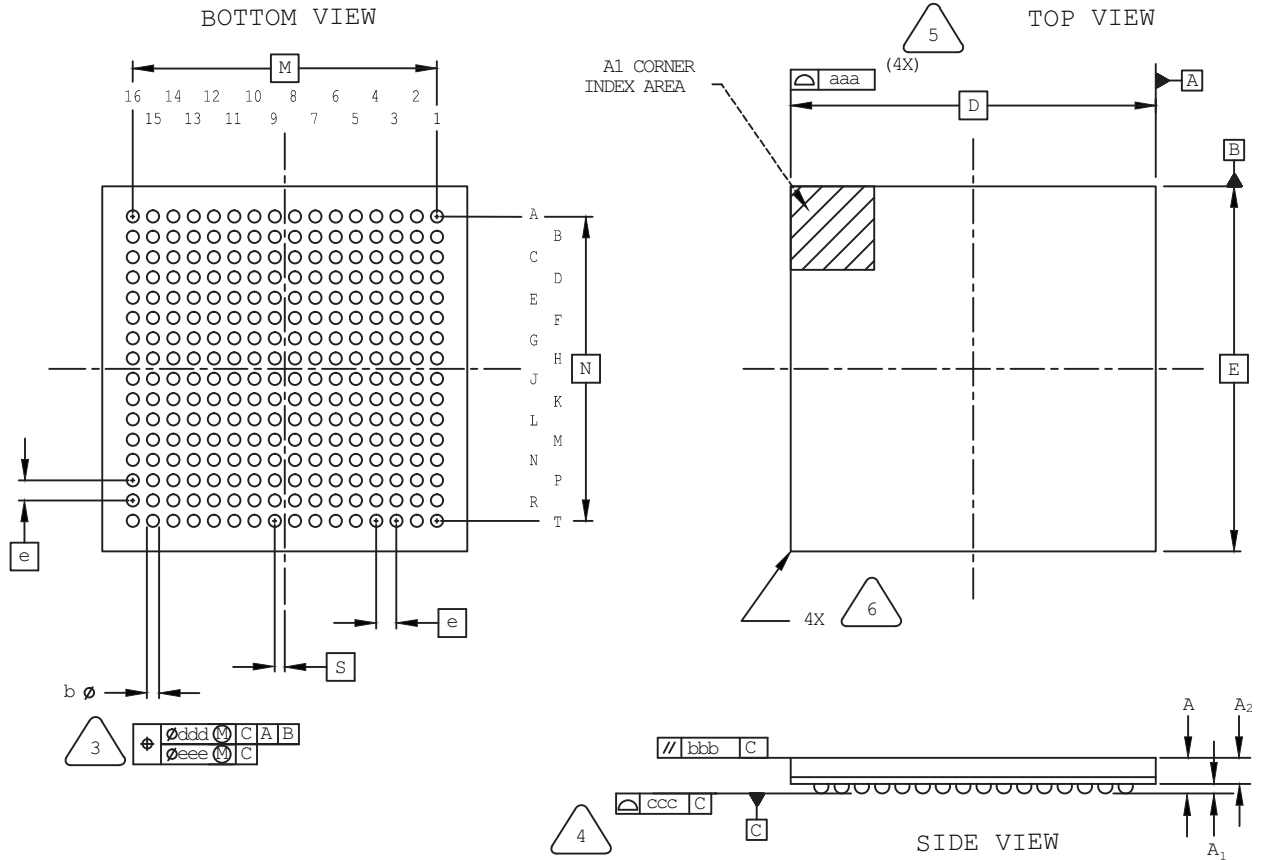

NOTES: UNLESS OTHERWISE SPECIFIED

1. DIMENSIONS AND TOLERANCES PER ANSI Y14.5M.
2. ALL DIMENSIONS ARE IN MILLIMETERS.



DIMENSION "b" IS MEASURED AT THE MAXIMUM SOLDER BALL DIAMETER, PARALLEL TO PRIMARY DATUM [C].



PRIMARY DATUM [C] AND SEATING PLANE ARE DEFINED BY THE SPHERICAL CROWNS OF THE SOLDER BALLS.



BILATERAL TOLERANCE ZONE IS APPLIED TO EACH SIDE OF THE PACKAGE BODY.



EXACT SHAPE AND SIZE OF THIS FEATURE IS OPTIONAL.

SYMBOL	MIN.	NOM.	MAX.
A	-	-	1.00
A1	0.15	0.24	-
A2	-	0.66	-
D/E	9.00 BSC		
M/N	7.50 BSC		
S	0.25 BSC		
b	0.25	0.30	0.35
e	0.50 BSC		
aaa	0.10		
bbb	0.10		
ccc	0.08		
ddd	0.15		
eee	0.05		

256-Ball ftBGA Package Option 1: ispMACH 4000, MachXO, LatticeXP2

Dimensions in Millimeters

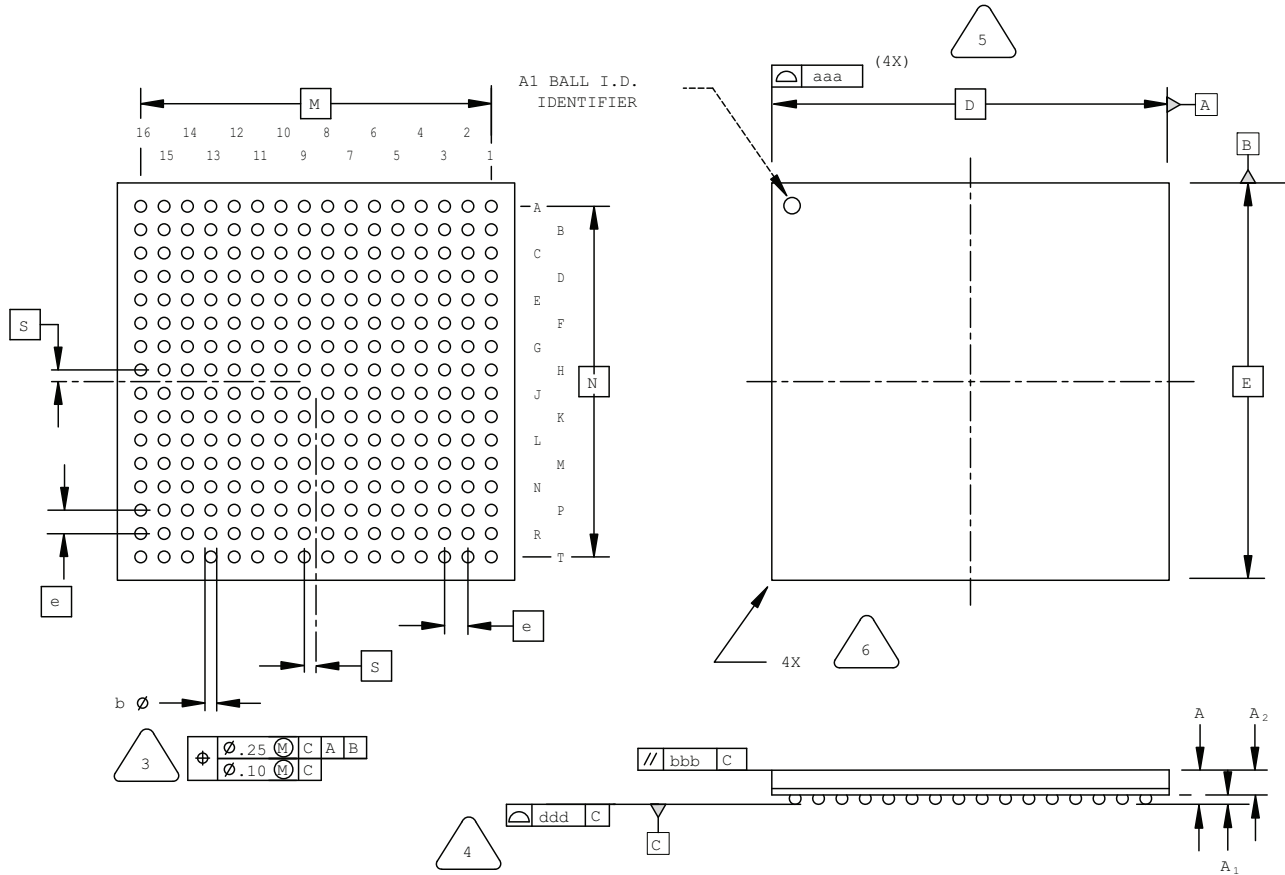

NOTES: UNLESS OTHERWISE SPECIFIED

- DIMENSIONS AND TOLERANCES PER ANSI Y14.5M.
- ALL DIMENSIONS ARE IN MILLIMETERS.



DIMENSION "b" IS MEASURED AT THE MAXIMUM SOLDER BALL DIAMETER, PARALLEL TO PRIMARY DATUM [C]



PRIMARY DATUM [C] AND SEATING PLANE ARE DEFINED BY THE SPHERICAL CROWNS OF THE SOLDER BALLS.



BILATERAL TOLERANCE ZONE IS APPLIED TO EACH SIDE OF THE PACKAGE BODY.



EXACT SHAPE AND SIZE OF THIS FEATURE IS OPTIONAL.

SYMBOL	MIN.	NOM.	MAX.
A	1.25	1.40	1.55
A1	0.30	-	-
A2	-	-	1.25
D/E	17.0 BSC		
M/N	15.0 BSC		
S	0.50 BSC		
b	0.40	0.50	0.60
e	1.00 BSC		
aaa	-	-	0.20
bbb	-	-	0.25
ddd	-	-	0.12

256-Ball ftBGA Package Option 2: LatticeECP3™

Dimensions in Millimeters

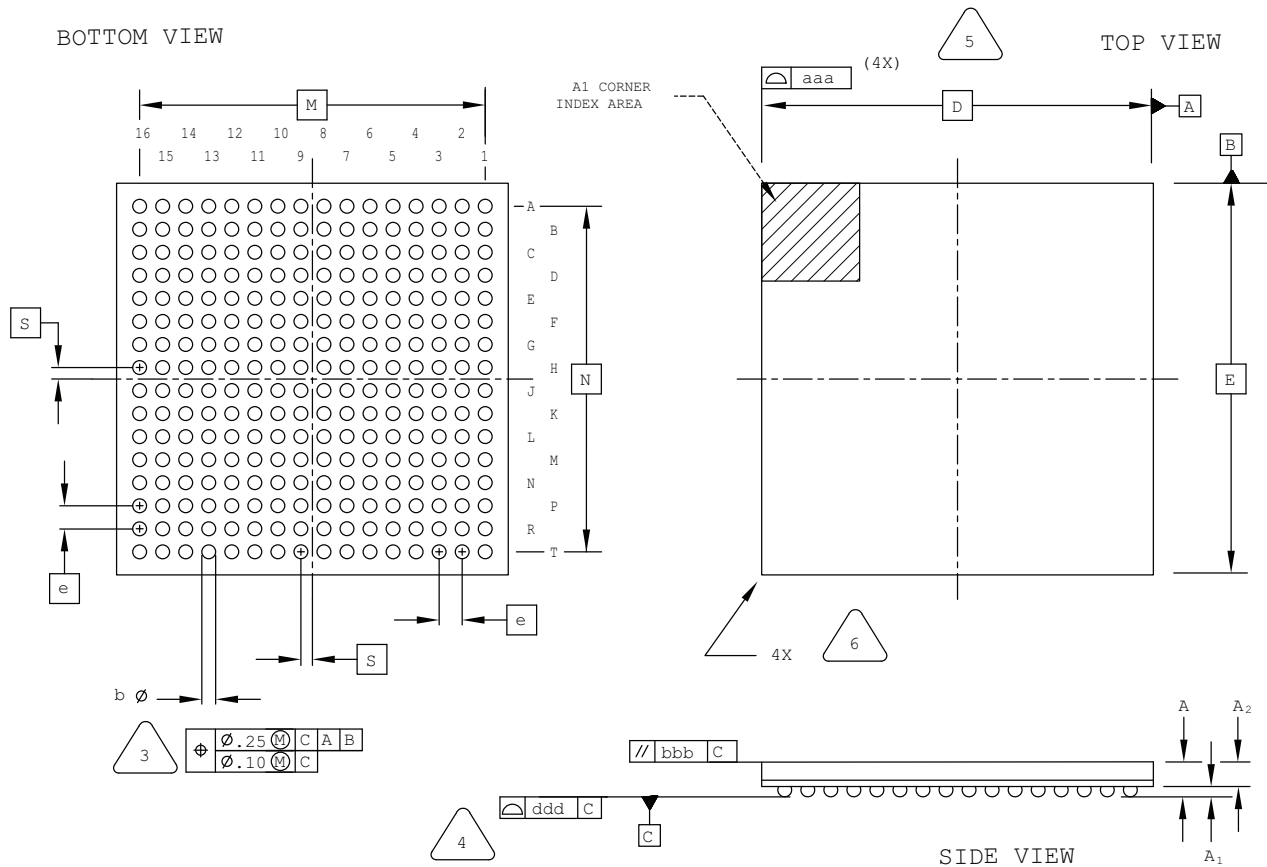

NOTES: UNLESS OTHERWISE SPECIFIED

- DIMENSIONS AND TOLERANCES PER ANSI Y14.5M.
- ALL DIMENSIONS ARE IN MILLIMETERS.



DIMENSION "b" IS MEASURED AT THE MAXIMUM SOLDER BALL DIAMETER, PARALLEL TO PRIMARY DATUM [C]



PRIMARY DATUM [C] AND SEATING PLANE ARE DEFINED BY THE SPHERICAL CROWNS OF THE SOLDER BALLS.



BILATERAL TOLERANCE ZONE IS APPLIED TO EACH SIDE OF THE PACKAGE BODY.



EXACT SHAPE AND SIZE OF THIS FEATURE IS OPTIONAL.

SYMBOL	MIN.	NOM.	MAX.
A	1.30	1.70	2.10
A1	0.30	0.50	0.70
A2	1.40 REF		
D/E	17.0 BSC		
M/N	15.0 BSC		
S	0.50 BSC		
b	0.50	0.60	0.70
e	1.0 BSC		
aaa	-	-	0.20
bbb	-	-	0.25
ddd	-	-	0.20

256-Ball ftBGA Package Option 3: MachXO2

Dimensions in Millimeters

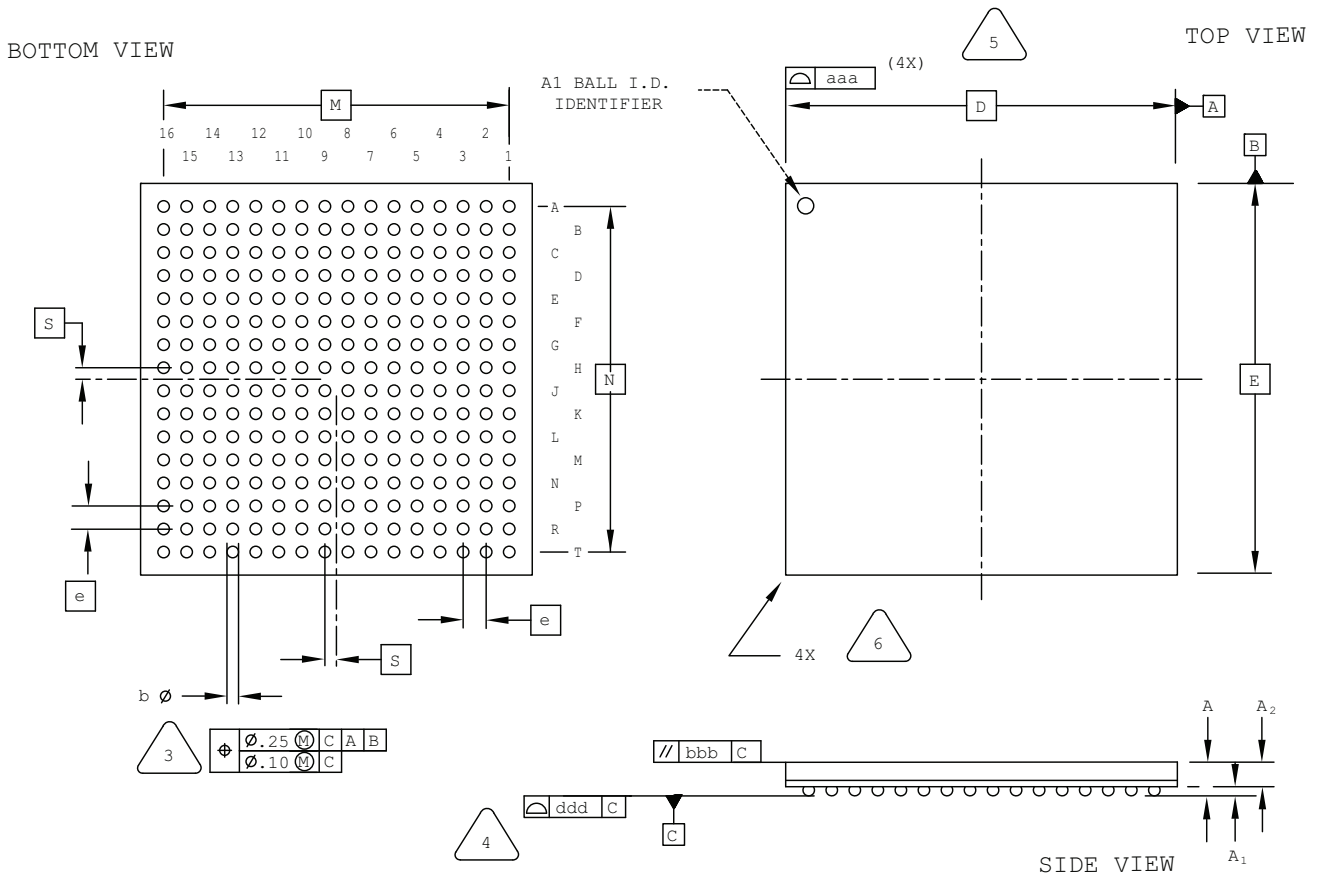

NOTES: UNLESS OTHERWISE SPECIFIED

1. DIMENSIONS AND TOLERANCES PER ANSI Y14.5M.
2. ALL DIMENSIONS ARE IN MILLIMETERS.



DIMENSION "b" IS MEASURED AT THE MAXIMUM SOLDER BALL DIAMETER, PARALLEL TO PRIMARY DATUM **C**



PRIMARY DATUM **C** AND SEATING PLANE ARE DEFINED BY THE SPHERICAL CROWNS OF THE SOLDER BALLS.



BILATERAL TOLERANCE ZONE IS APPLIED TO EACH SIDE OF THE PACKAGE BODY.



EXACT SHAPE AND SIZE OF THIS FEATURE IS OPTIONAL.

SYMBOL	MIN.	NOM.	MAX.
A	1.40	1.55	1.70
A1	0.30	-	-
A2	1.00	-	-
D/E	17.0 BSC		
M/N	15.0 BSC		
S	0.50 BSC		
b	0.40	0.50	0.60
e	1.0 BSC		
aaa	-	-	0.20
bbb	-	-	0.25
ddd	-	-	0.12

256-Ball fpBGA Package

Dimensions in Millimeters

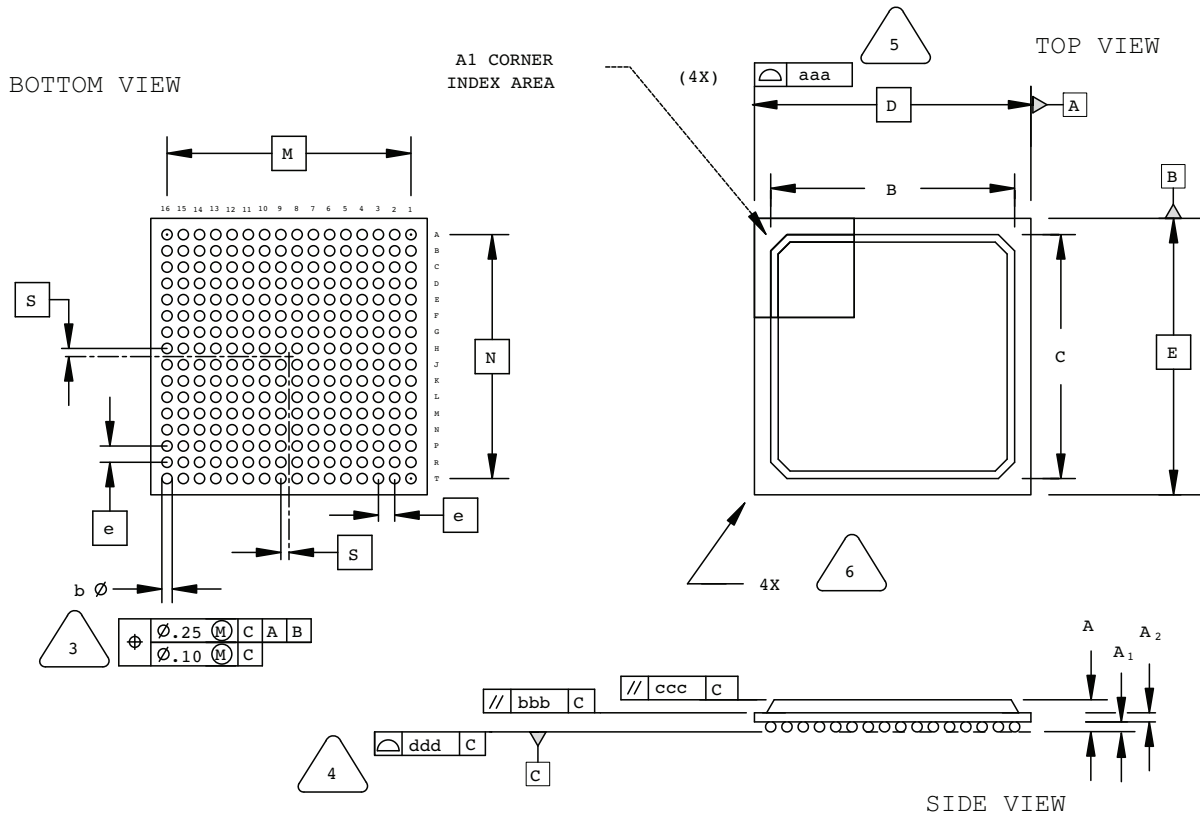

NOTES: UNLESS OTHERWISE SPECIFIED

- DIMENSIONS AND TOLERANCES PER ANSI Y14.5M.
- ALL DIMENSIONS ARE IN MILLIMETERS.



DIMENSION "b" IS MEASURED AT THE MAXIMUM SOLDER BALL DIAMETER, PARALLEL TO PRIMARY DATUM **C**



PRIMARY DATUM **C** AND SEATING PLANE ARE DEFINED BY THE SPHERICAL CROWNS OF THE SOLDER BALLS.



BILATERAL TOLERANCE ZONE IS APPLIED TO EACH SIDE OF THE PACKAGE BODY.



EXACT SHAPE AND SIZE OF THIS FEATURE IS OPTIONAL.

SYMBOL	MIN.	NOM.	MAX.
A	1.30	1.70	2.10
A1	0.30	0.50	0.70
A2	0.30	0.50	0.70
B/C	14.80	15.30	15.80
D/E	17.00 BSC		
M/N	15.00 BSC		
S	0.50 BSC		
b	0.50	0.60	0.70
e	1.00 BSC		
aaa	-	-	0.20
bbb	-	-	0.25
ccc	-	-	0.35
ddd	-	-	0.20

256-Ball SBGA Package

Dimensions in Millimeters

BOTTOM VIEW

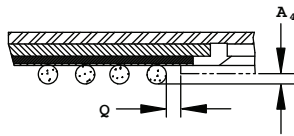
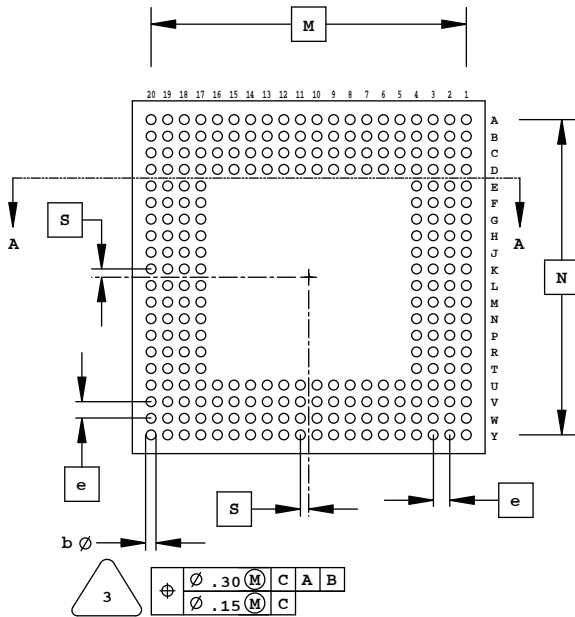

A-A SECTION VIEW

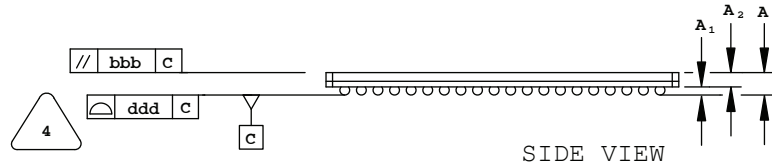
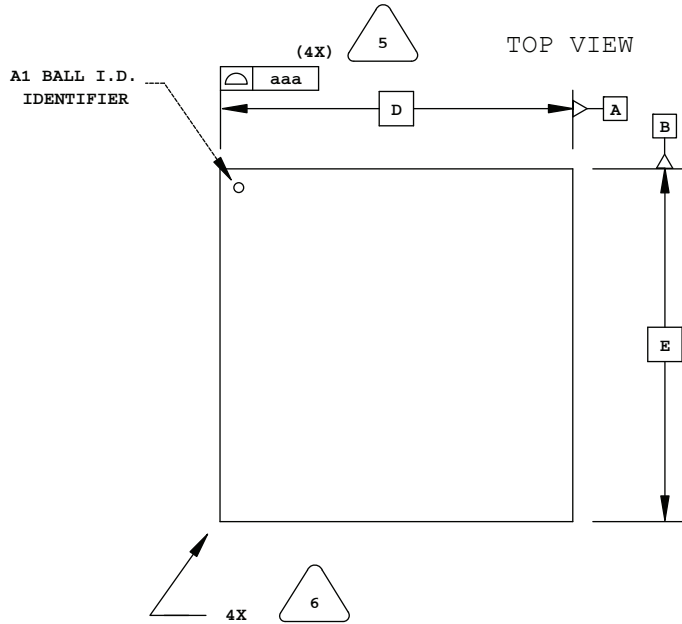

SIDE VIEW

NOTES: UNLESS OTHERWISE SPECIFIED

- DIMENSIONS AND TOLERANCES PER ANSI Y14.5M.
- ALL DIMENSIONS ARE IN MILLIMETERS.



DIMENSION "b" IS MEASURED AT THE MAXIMUM SOLDER BALL DIAMETER, PARALLEL TO PRIMARY DATUM **C**



PRIMARY DATUM **C** AND SEATING PLANE ARE DEFINED BY THE SPHERICAL CROWNS OF THE SOLDER BALLS.



BILATERAL TOLERANCE ZONE IS APPLIED TO EACH SIDE OF THE PACKAGE BODY.



EXACT SHAPE AND SIZE OF THIS FEATURE IS OPTIONAL.

SYMBOL	MIN.	NOM.	MAX.
A	-	-	1.70
A1	0.50	0.65	0.80
A2	0.80	0.90	1.00
D/E	27.00 BSC		
M/N	24.13 BSC		
S	0.635 BSC		
b	0.60	0.75	0.90
e	1.27 BSC		
Q	0.25	-	-
A4	0.10	-	-
aaa	-	-	0.20
bbb	-	-	0.25
ddd	-	-	0.20

272-Ball BGA Package

Dimensions in Millimeters

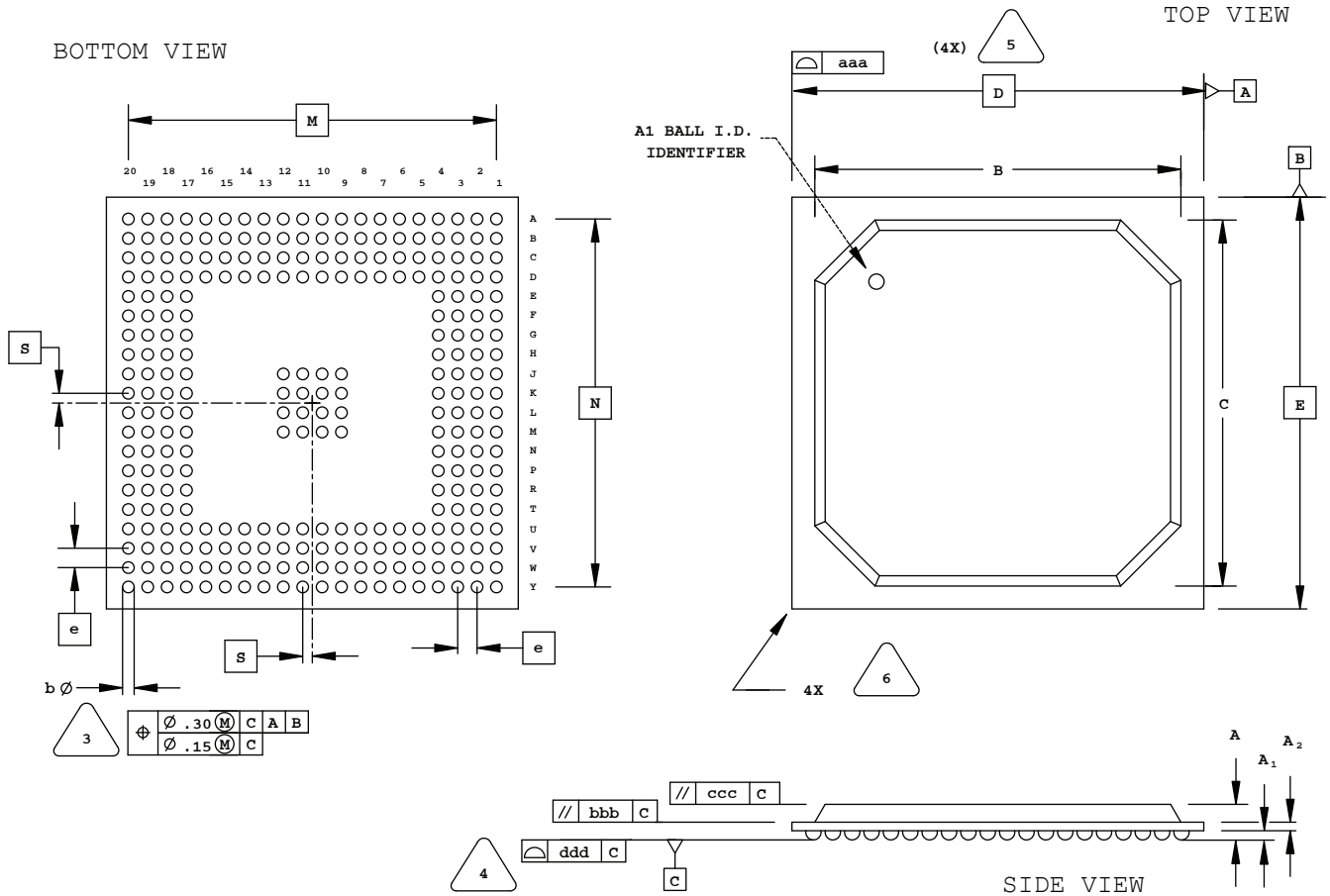



NOTES: UNLESS OTHERWISE SPECIFIED

1. DIMENSIONS AND TOLERANCES PER ANSI Y14.5M.
2. ALL DIMENSIONS ARE IN MILLIMETERS.

 DIMENSION "b" IS MEASURED AT THE MAXIMUM SOLDER BALL DIAMETER, PARALLEL TO PRIMARY DATUM \square C

 PRIMARY DATUM \square C AND SEATING PLANE ARE DEFINED BY THE SPHERICAL CROWNS OF THE SOLDER BALLS.

 BILATERAL TOLERANCE ZONE IS APPLIED TO EACH SIDE OF THE PACKAGE BODY.

 EXACT SHAPE AND SIZE OF THIS FEATURE IS OPTIONAL.

SYMBOL	MIN.	NOM.	MAX.
A	1.90	2.25	2.80
A1	0.50	0.65	0.80
A2	0.28	0.54	0.80
B/C	23.80	24.30	24.80
D/E	27.00 BSC		
M/N	24.13 BSC		
S	0.635 BSC		
b	0.60	0.75	0.90
e	1.27 BSC		
aaa	-	-	0.20
bbb	-	-	0.25
ccc	-	-	0.35
ddd	-	-	0.20

284-Ball csBGA Package

Dimensions in Millimeters

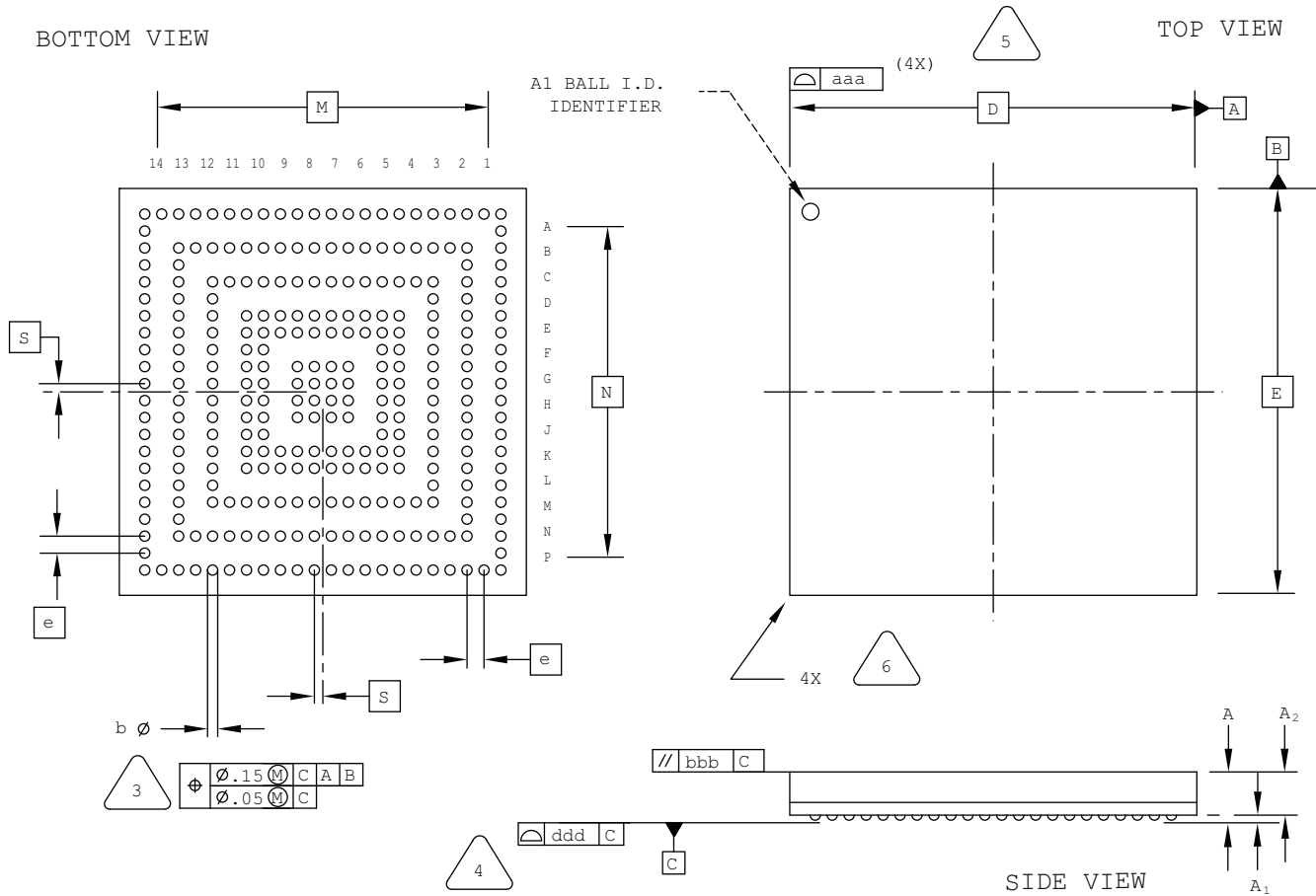

NOTES: UNLESS OTHERWISE SPECIFIED

- DIMENSIONS AND TOLERANCES PER ANSI Y14.5M.
- ALL DIMENSIONS ARE IN MILLIMETERS.



DIMENSION "b" IS MEASURED AT THE MAXIMUM SOLDER BALL DIAMETER, PARALLEL TO PRIMARY DATUM [C]



PRIMARY DATUM [C] AND SEATING PLANE ARE DEFINED BY THE SPHERICAL CROWNS OF THE SOLDER BALLS.



BILATERAL TOLERANCE ZONE IS APPLIED TO EACH SIDE OF THE PACKAGE BODY.



EXACT SHAPE AND SIZE OF THIS FEATURE IS OPTIONAL.

SYMBOL	MIN.	NOM.	MAX.
A	-	-	1.00
A1	0.15	-	-
A2	-	-	0.85
D/E	12.00 BSC		
M/N	10.50 BSC		
S	0.25 BSC		
b	0.25	0.31	0.37
e	0.50 BSC		
aaa	-	-	0.10
bbb	-	-	0.10
ddd	-	-	0.08

285-Ball csfBGA Package

Dimensions in Millimeters

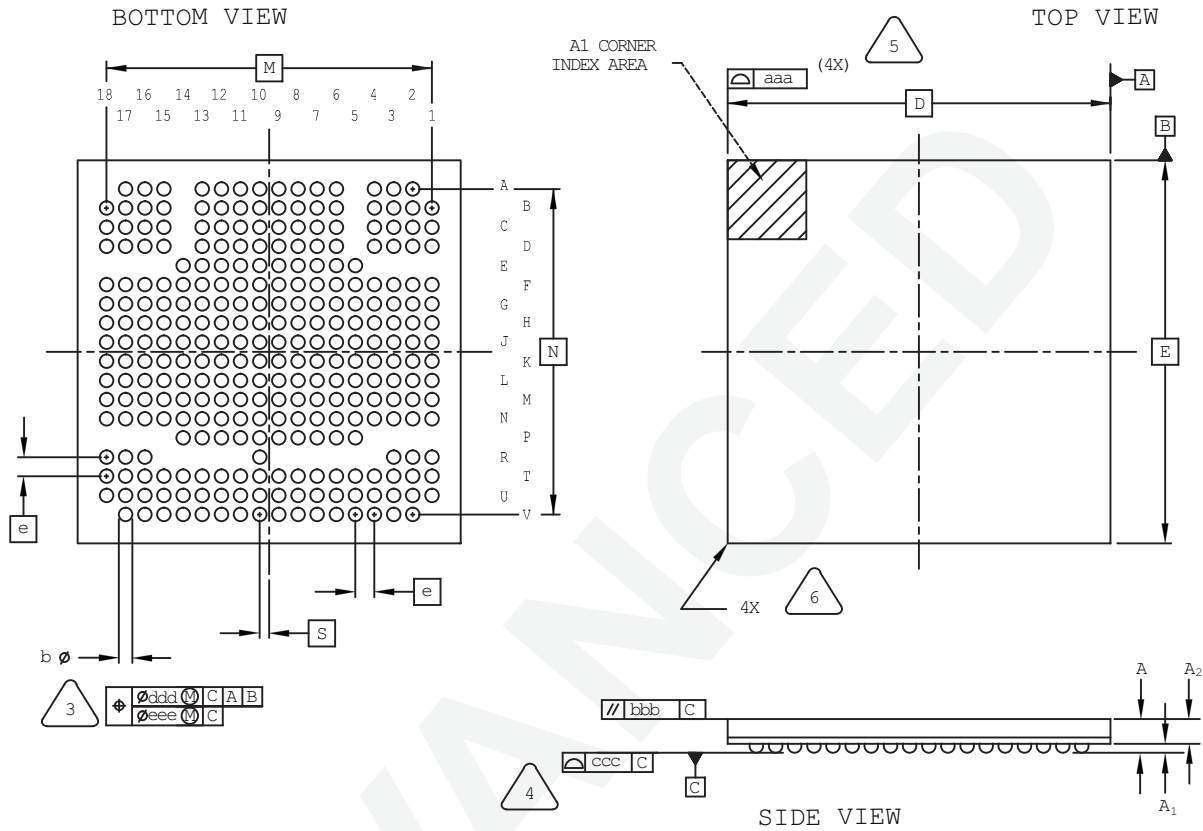

NOTES: UNLESS OTHERWISE SPECIFIED

1. DIMENSIONS AND TOLERANCES PER ANSI Y14.5M.
2. ALL DIMENSIONS ARE IN MILLIMETERS.



DIMENSION "b" IS MEASURED AT THE MAXIMUM SOLDER BALL DIAMETER, PARALLEL TO PRIMARY DATUM [C]



PRIMARY DATUM [C] AND SEATING PLANE ARE DEFINED BY THE SPHERICAL CROWNS OF THE SOLDER BALLS.



BILATERAL TOLERANCE ZONE IS APPLIED TO EACH SIDE OF THE PACKAGE BODY.



EXACT SHAPE AND SIZE OF THIS FEATURE IS OPTIONAL.

SYMBOL	MIN.	NOM.	MAX.
A	-	-	1.11
A1	0.15	0.23	-
A2	-	0.78	-
D/E	10.00 BSC		
M/N	8.50 BSC		
S	0.25 BSC		
b	0.25	0.30	0.35
e	0.50 BSC		
aaa	0.10		
bbb	0.10		
ccc	0.08		
ddd	0.15		
eee	0.05		

320-Ball SBGA Package

Dimensions in Millimeters

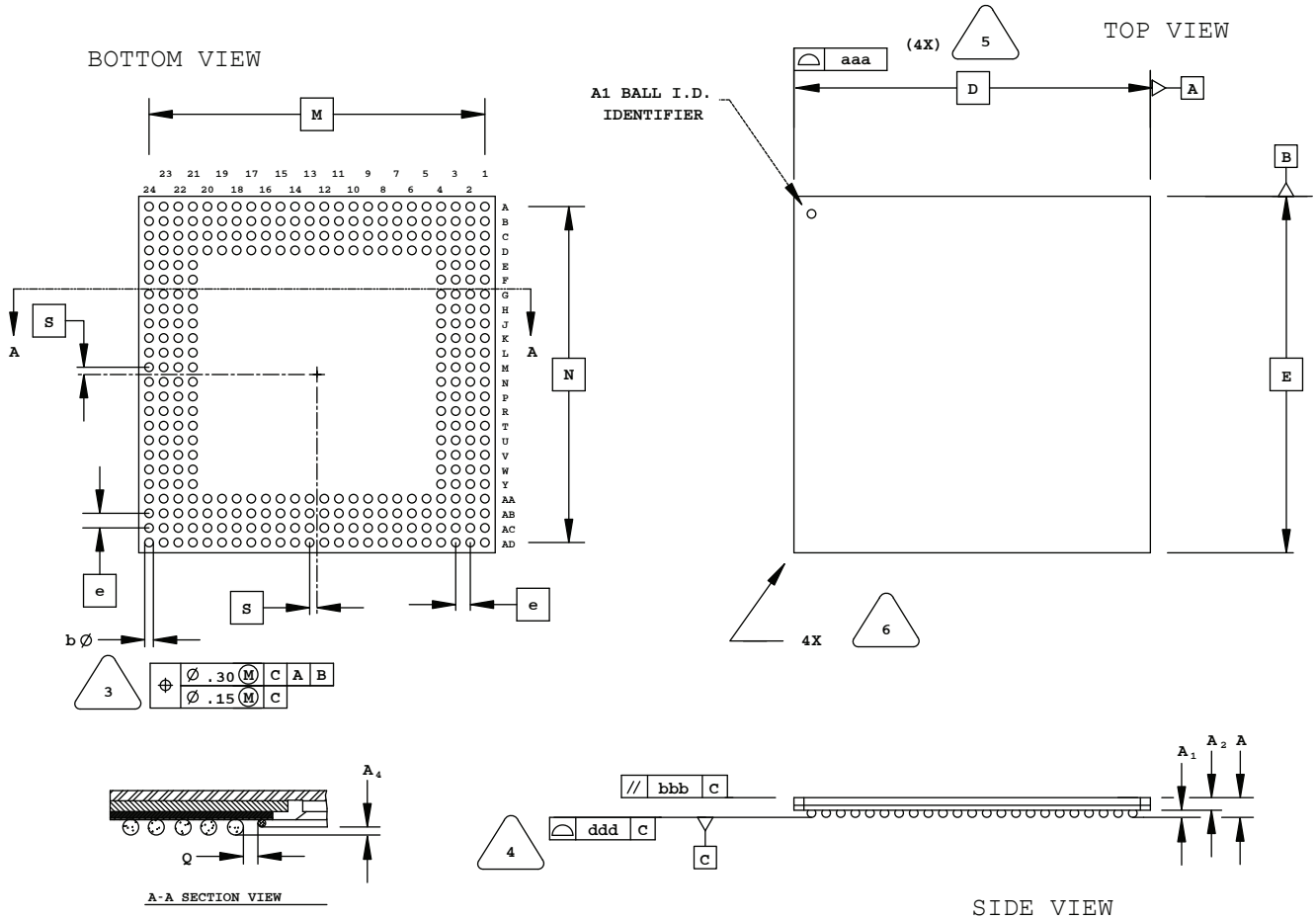

NOTES: UNLESS OTHERWISE SPECIFIED

- DIMENSIONS AND TOLERANCES PER ANSI Y14.5M.
- ALL DIMENSIONS ARE IN MILLIMETERS.



DIMENSION "b" IS MEASURED AT THE MAXIMUM SOLDER BALL DIAMETER, PARALLEL TO PRIMARY DATUM **C**



PRIMARY DATUM **C** AND SEATING PLANE ARE DEFINED BY THE SPHERICAL PLANE OF THE SOLDER BALLS.



BILATERAL TOLERANCE ZONE IS APPLIED TO EACH SIDE OF THE PACKAGE BODY.



EXACT SHAPE AND SIZE OF THIS FEATURE IS OPTIONAL.

SYMBOL	MIN.	NOM.	MAX.
A	-	-	1.70
A1	0.50	0.65	0.80
A2	0.80	0.90	1.00
D/E	31.00 BSC		
M/N	29.21 BSC		
S	0.635 BSC		
b	0.60	0.75	0.90
e	1.27 BSC		
Q	0.25	-	-
A4	0.10	-	-
aaa	-	-	0.20
bbb	-	-	0.25
ddd	-	-	0.20

324-Ball caBGA Package

Dimensions in Millimeters

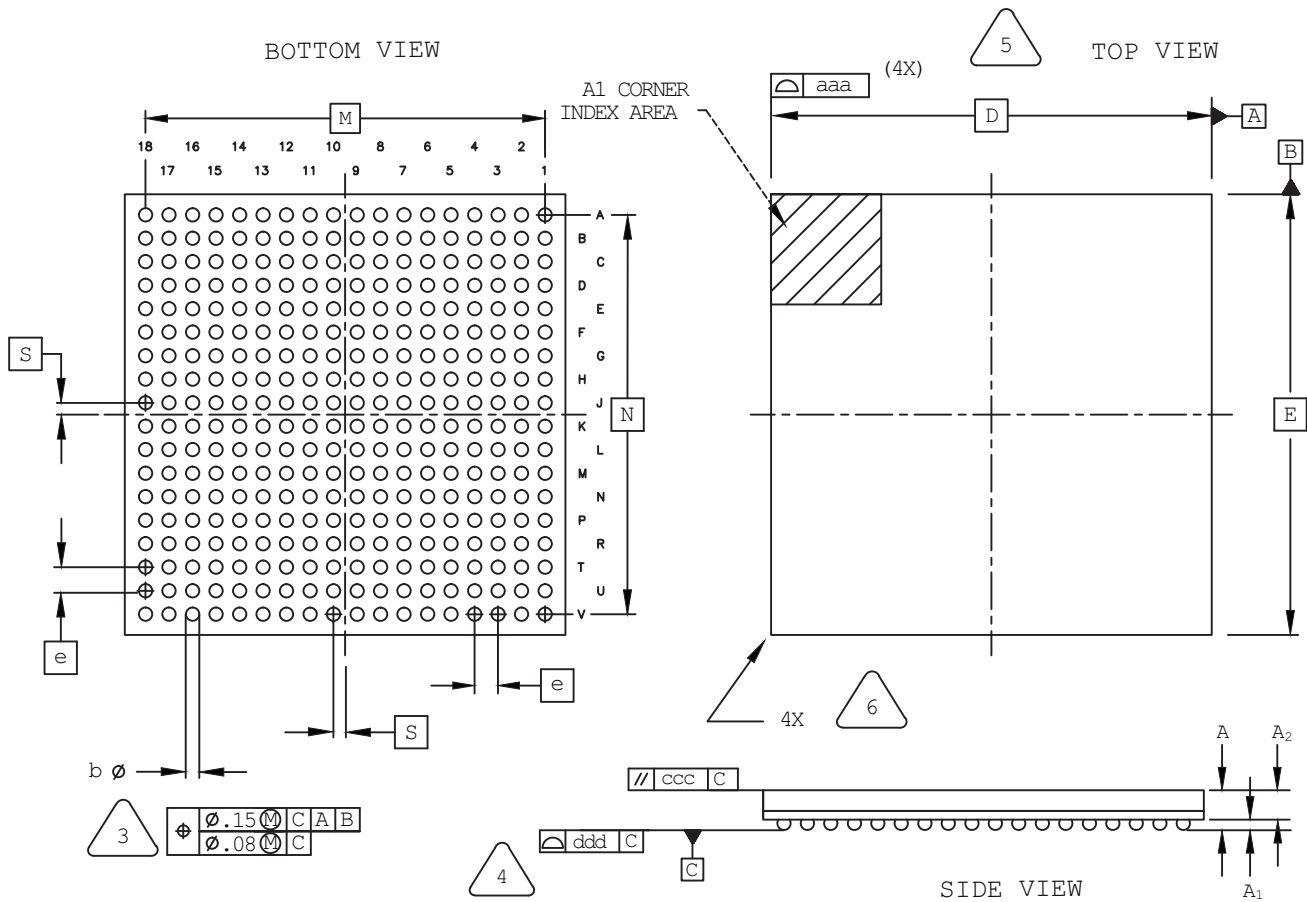

NOTES: UNLESS OTHERWISE SPECIFIED

- DIMENSIONS AND TOLERANCES PER ANSI Y14.5M.
- ALL DIMENSIONS ARE IN MILLIMETERS.



DIMENSION "b" IS MEASURED AT THE MAXIMUM SOLDER BALL DIAMETER, PARALLEL TO PRIMARY DATUM [C].



PRIMARY DATUM [C] AND SEATING PLANE ARE DEFINED BY THE SPHERICAL CROWNS OF THE SOLDER BALLS.



BILATERAL TOLERANCE ZONE IS APPLIED TO EACH SIDE OF THE PACKAGE BODY.



EXACT SHAPE AND SIZE OF THIS FEATURE IS OPTIONAL.

SYMBOL	MIN.	NOM.	MAX.
A	-	-	1.70
A1	0.25	0.35	-
A2	0.80	1.00	-
D/E	15.0 BSC		
M/N	13.6 BSC		
S	0.40 BSC		
b	0.40	0.45	0.50
e	0.80 BSC		
aaa	-	-	0.15
ccc	-	-	0.20
ddd	-	-	0.20

324-Ball csfBGA Package

Dimensions in Millimeters

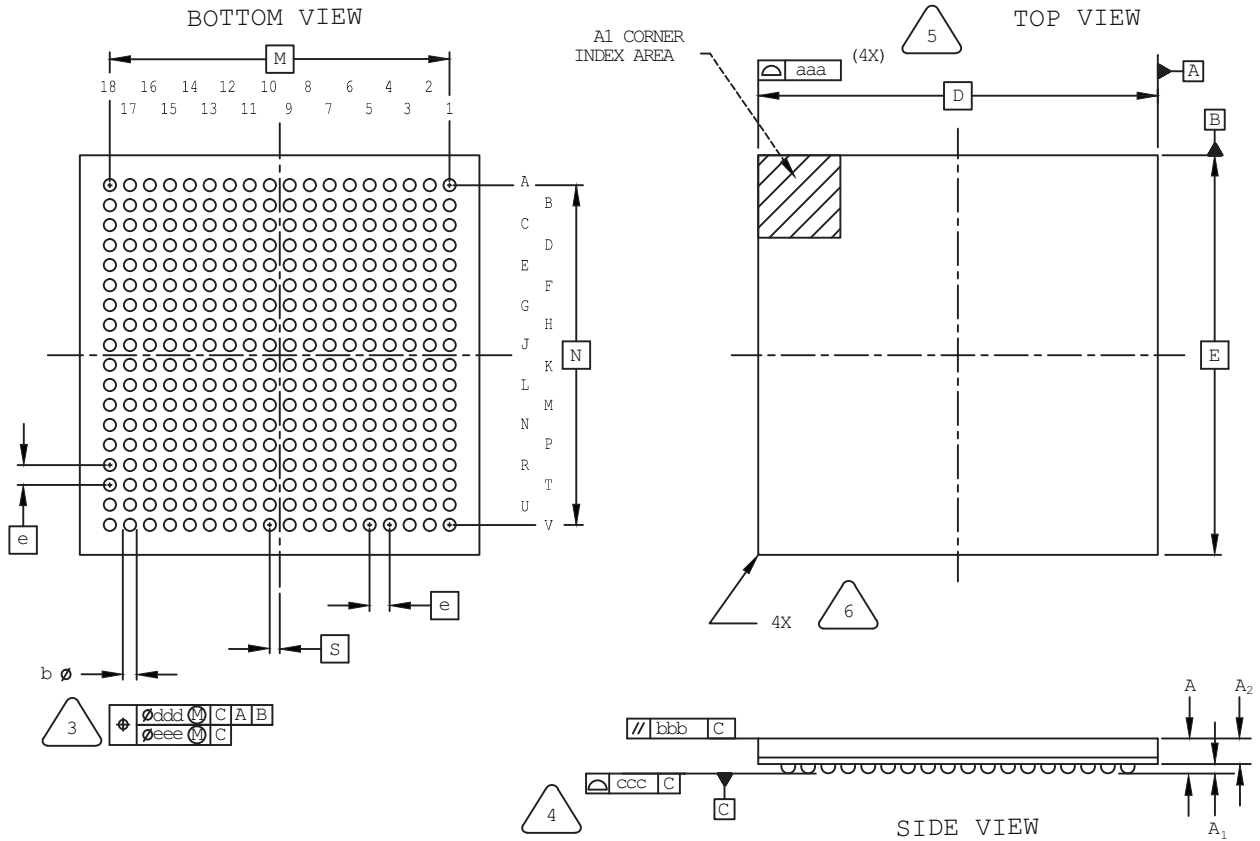

NOTES: UNLESS OTHERWISE SPECIFIED

1. DIMENSIONS AND TOLERANCES PER ANSI Y14.5M.
2. ALL DIMENSIONS ARE IN MILLIMETERS.



DIMENSION "b" IS MEASURED AT THE MAXIMUM SOLDER BALL DIAMETER, PARALLEL TO PRIMARY DATUM [C].



PRIMARY DATUM [C] AND SEATING PLANE ARE DEFINED BY THE SPHERICAL CROWNS OF THE SOLDER BALLS.



BILATERAL TOLERANCE ZONE IS APPLIED TO EACH SIDE OF THE PACKAGE BODY.



EXACT SHAPE AND SIZE OF THIS FEATURE IS OPTIONAL.

SYMBOL	MIN.	NOM.	MAX.
A	-	-	1.00
A1	0.15	0.24	-
A2	-	0.66	-
D/E	10.00 BSC		
M/N	8.50 BSC		
S	0.25 BSC		
b	0.25	0.30	0.35
e	0.50 BSC		
aaa	0.10		
bbb	0.10		
ccc	0.08		
ddd	0.15		
eee	0.05		

324-Ball ftBGA Package

Dimensions in Millimeters

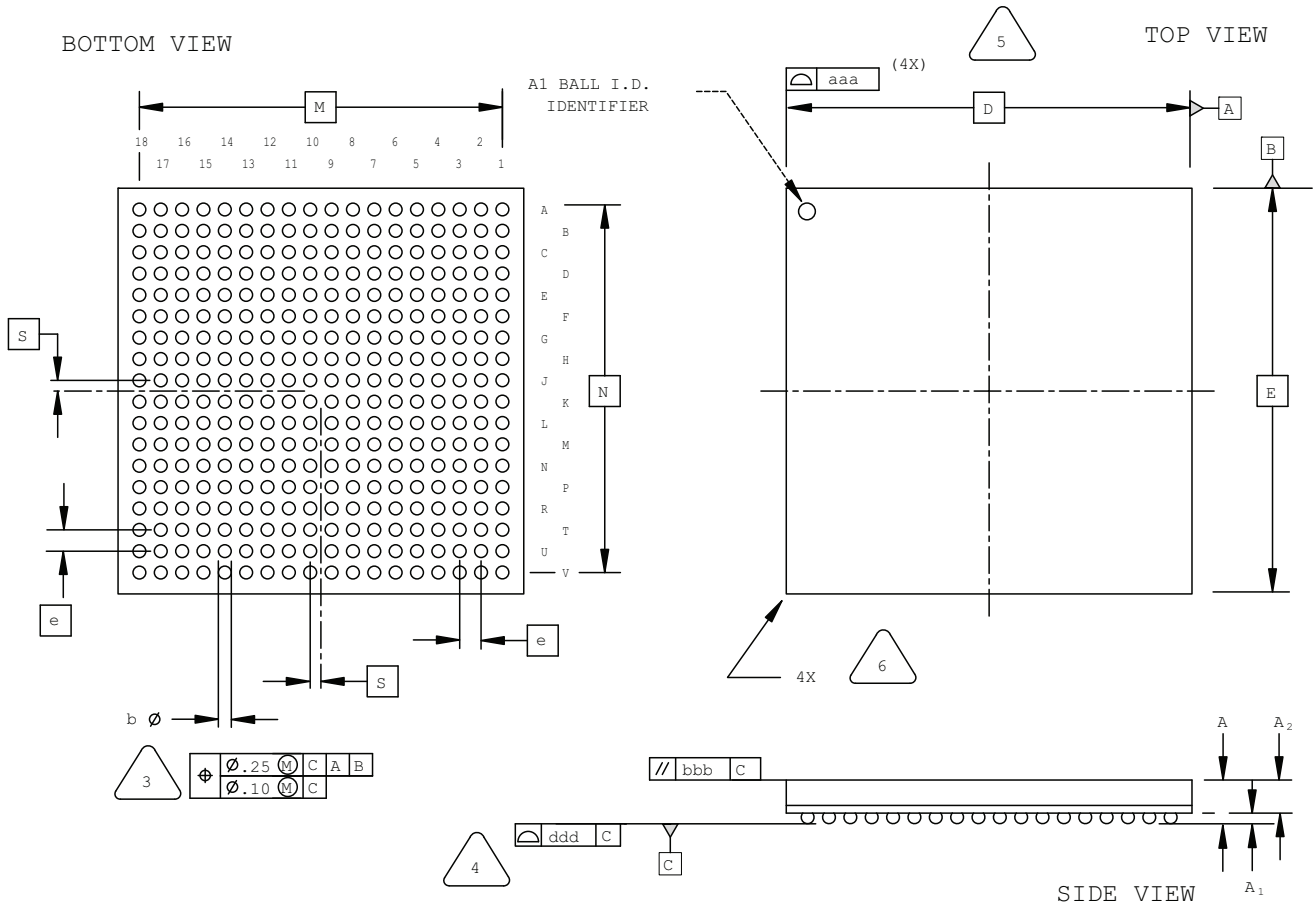

NOTES: UNLESS OTHERWISE SPECIFIED

1. DIMENSIONS AND TOLERANCES PER ANSI Y14.5M.
2. ALL DIMENSIONS ARE IN MILLIMETERS.



DIMENSION "b" IS MEASURED AT THE MAXIMUM SOLDER BALL DIAMETER, PARALLEL TO PRIMARY DATUM [C]



PRIMARY DATUM [C] AND SEATING PLANE ARE DEFINED BY THE SPHERICAL CROWNS OF THE SOLDER BALLS.



BILATERAL TOLERANCE ZONE IS APPLIED TO EACH SIDE OF THE PACKAGE BODY.



EXACT SHAPE AND SIZE OF THIS FEATURE IS OPTIONAL.

SYMBOL	MIN.	NOM.	MAX.
A	1.25	1.50	1.70
A1	0.30	-	-
A2	-	-	1.40
D/E	19.0 BSC		
M/N	17.0 BSC		
S	0.50 BSC		
b	0.40	0.60	0.70
e	1.00 BSC		
aaa	-	-	0.20
bbb	-	-	0.25
ddd	-	-	0.20

328-Ball csBGA Package

Dimensions in Millimeters

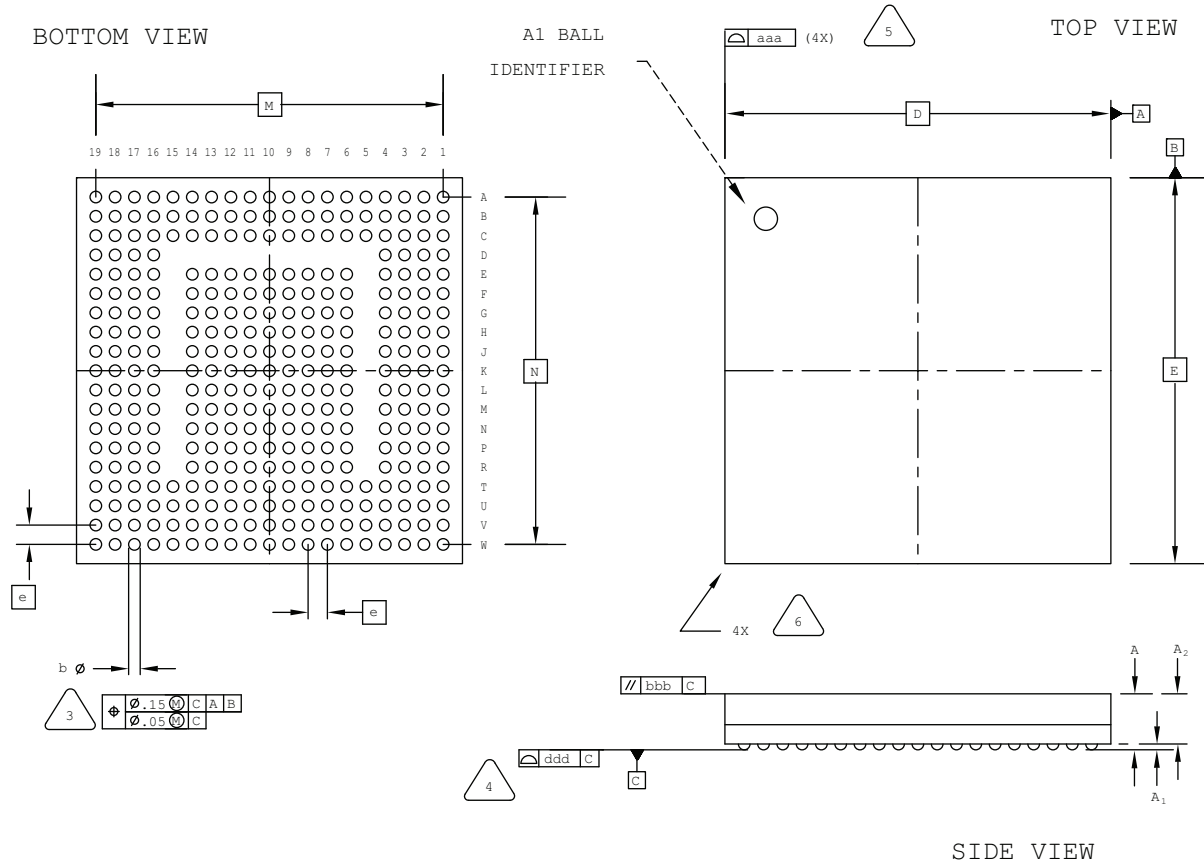

NOTES: UNLESS OTHERWISE SPECIFIED

- DIMENSIONS AND TOLERANCES PER ANSI Y14.5M.
- ALL DIMENSIONS ARE IN MILLIMETERS.



DIMENSION "b" IS MEASURED AT THE MAXIMUM SOLDER BALL DIAMETER, PARALLEL TO PRIMARY DATUM [C]



PRIMARY DATUM [C] AND SEATING PLANE ARE DEFINED BY THE SPHERICAL CROWNS OF THE SOLDER BALLS.



BILATERAL TOLERANCE ZONE IS APPLIED TO EACH SIDE OF THE PACKAGE BODY.



EXACT SHAPE AND SIZE OF THIS FEATURE IS OPTIONAL.

SYMBOL	MIN.	NOM.	MAX.
A	1.05	1.35	1.50
A1	0.15	-	-
A2	-	-	1.20
D/E	10.0 BSC		
M/N	9.00 BSC		
b	0.25	0.30	0.35
e	0.50 BSC		
aaa	-	-	0.10
bbb	-	-	0.10
ddd	-	-	0.08

332-Ball caBGA Package

Dimensions in Millimeters

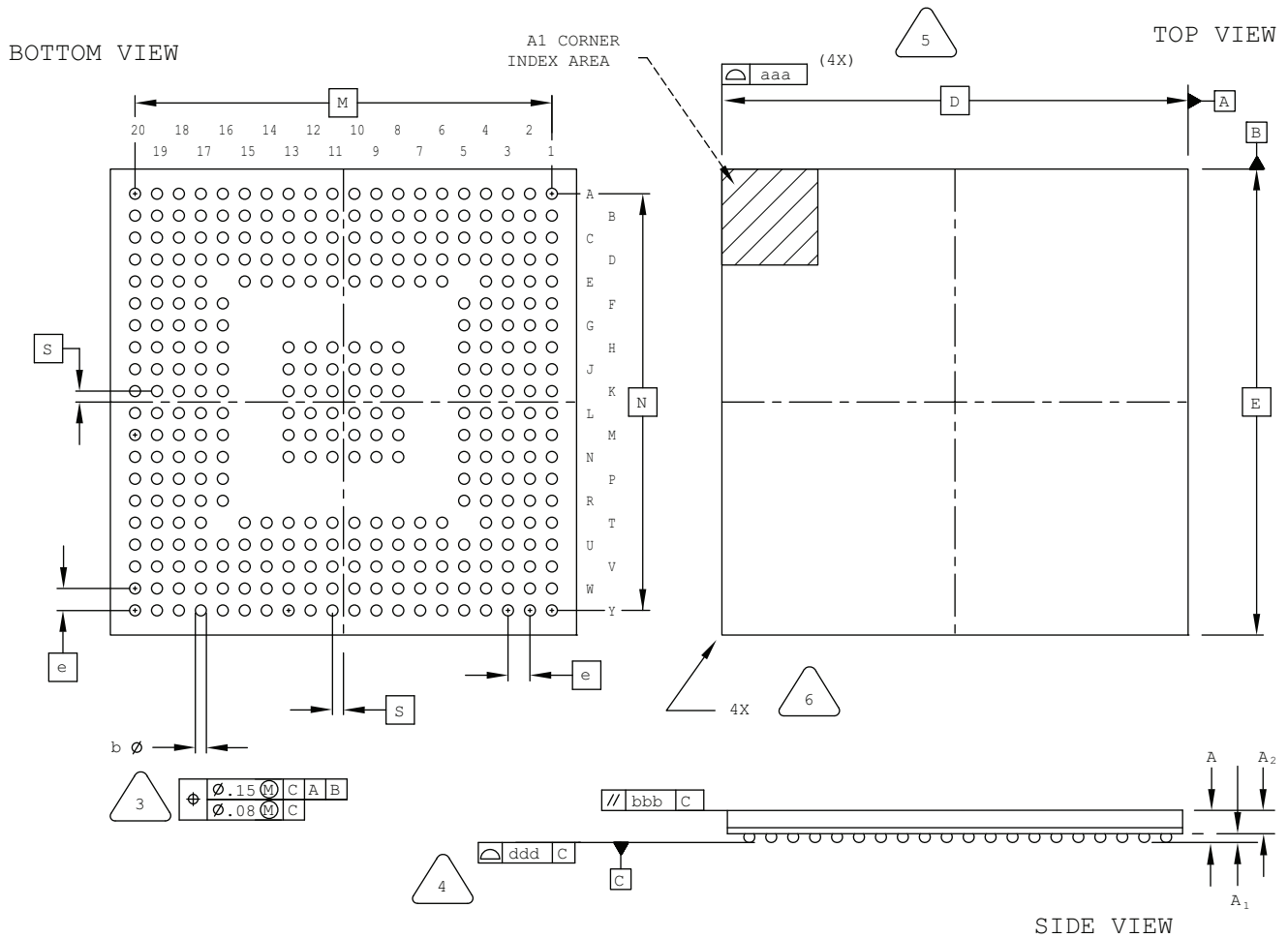

NOTES: UNLESS OTHERWISE SPECIFIED

1. DIMENSIONS AND TOLERANCES PER ANSI Y14.5M.
2. ALL DIMENSIONS ARE IN MILLIMETERS.



DIMENSION "b" IS MEASURED AT THE MAXIMUM SOLDER BALL DIAMETER, PARALLEL TO PRIMARY DATUM [C]



PRIMARY DATUM [C] AND SEATING PLANE ARE DEFINED BY THE SPHERICAL CROWNS OF THE SOLDER BALLS.



BILATERAL TOLERANCE ZONE IS APPLIED TO EACH SIDE OF THE PACKAGE BODY.



EXACT SHAPE AND SIZE OF THIS FEATURE IS OPTIONAL.

SYMBOL	MIN.	NOM.	MAX.
A	-	-	2.00
A1	0.25	-	-
A2	0.65	-	-
D/E	17.0 BSC		
M/N	15.2 BSC		
S	0.40 BSC		
b	0.40	0.45	0.50
e	0.80 BSC		
aaa	-	-	0.15
bbb	-	-	0.20
ddd	-	-	0.20

352-Ball SBGA Package

Dimensions in Millimeters

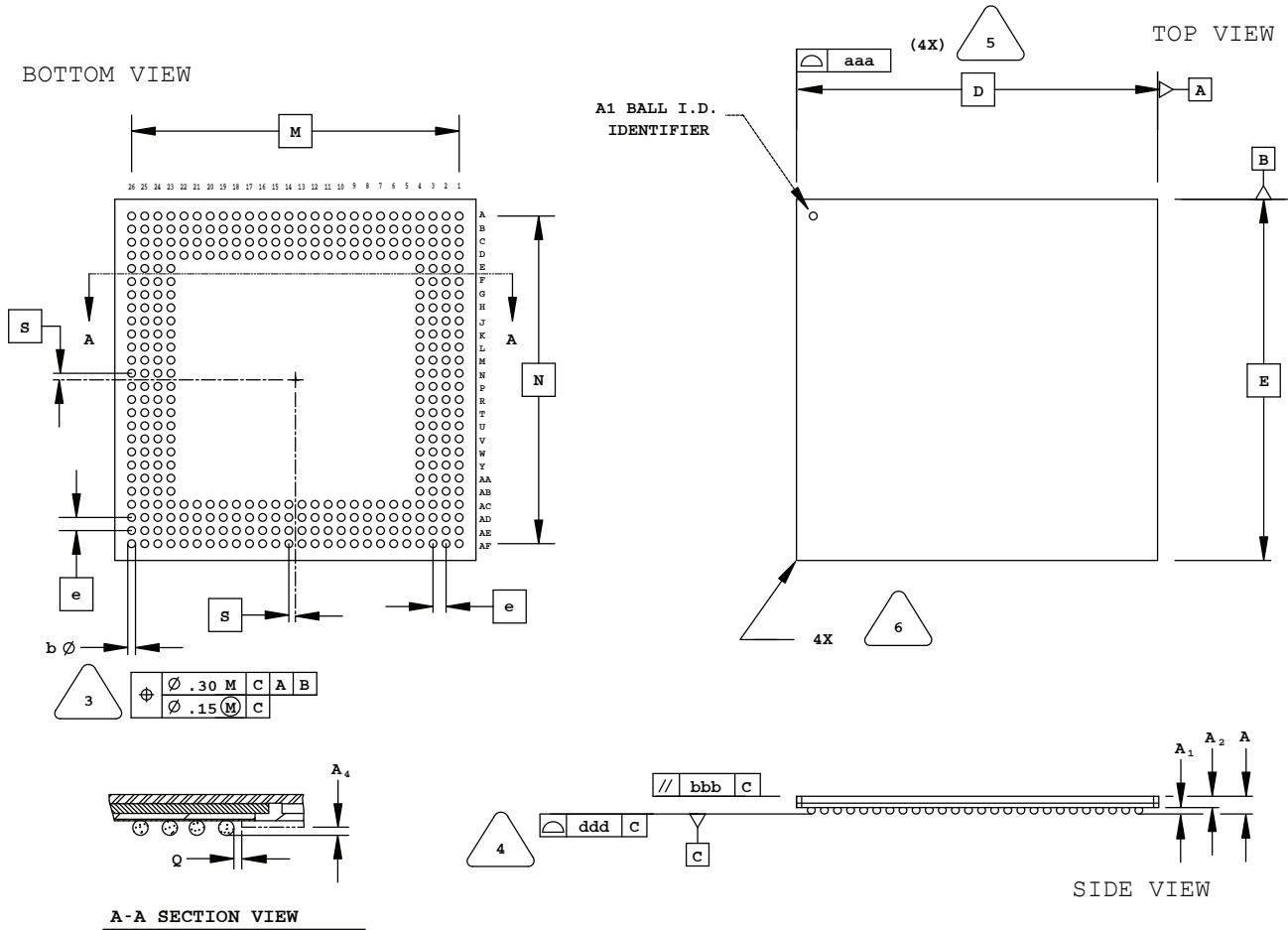



NOTES: UNLESS OTHERWISE SPECIFIED

- DIMENSIONS AND TOLERANCES PER ANSI Y14.5M.
- ALL DIMENSIONS ARE IN MILLIMETERS.

- 

DIMENSION "b" IS MEASURED AT THE MAXIMUM SOLDER BALL DIAMETER, PARALLEL TO PRIMARY DATUM **C**
- 

PRIMARY DATUM **C** AND SEATING PLANE ARE DEFINED BY THE SPHERICAL CROWNS OF THE SOLDER BALLS.
- 

BILATERAL TOLERANCE ZONE IS APPLIED TO EACH SIDE OF THE PACKAGE BODY.
- 

EXACT SHAPE AND SIZE OF THIS FEATURE IS OPTIONAL.

SYMBOL	MIN.	NOM.	MAX.
A	-	-	1.70
A1	0.50	0.65	0.80
A2	0.80	0.90	1.00
D/E	35.00 BSC		
M/N	31.75 BSC		
S	0.635 BSC		
b	0.60	0.75	0.90
e	1.27 BSC		
Q	0.25	-	-
A4	0.10	-	-
aaa	-	-	0.20
bbb	-	-	0.25
ddd	-	-	0.20

381-Ball caBGA Package

Dimensions in Millimeters

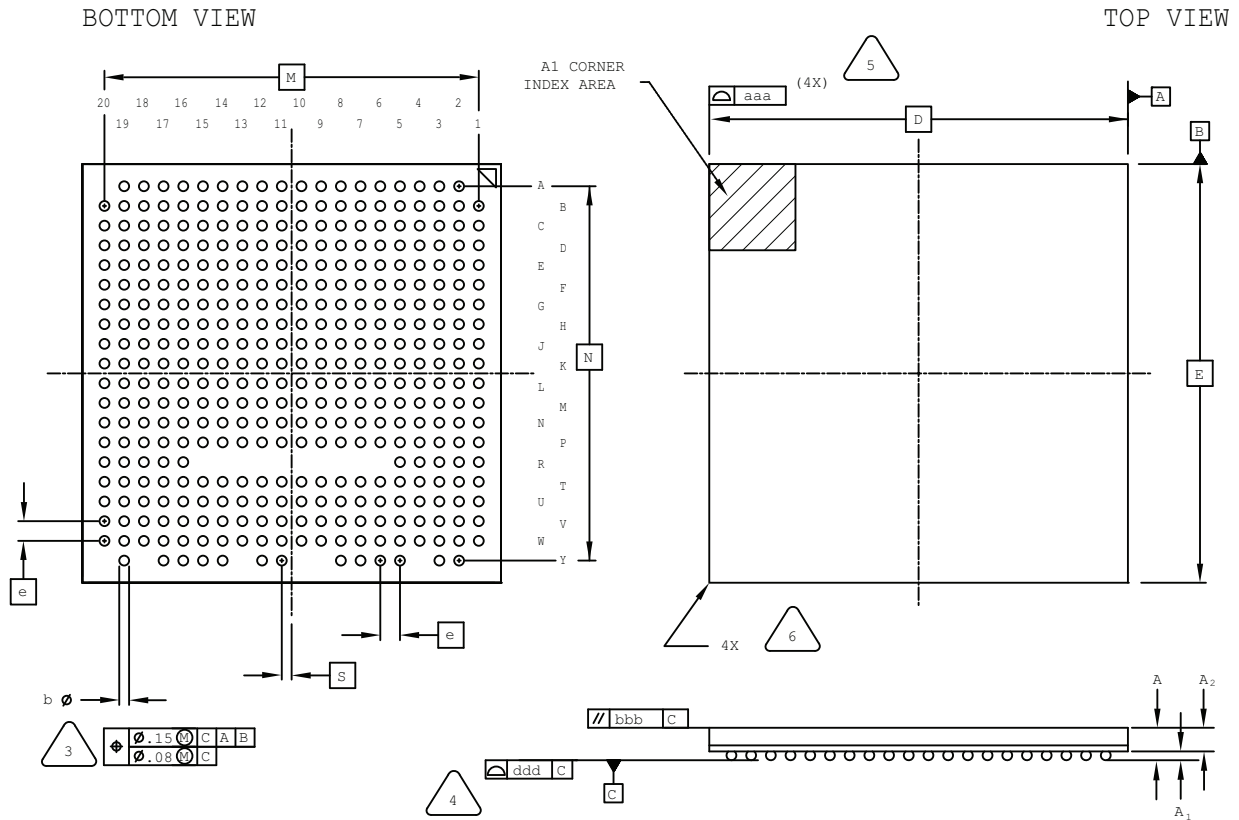

NOTES: UNLESS OTHERWISE SPECIFIED

1. DIMENSIONS AND TOLERANCES PER ANSI Y14.5M.
2. ALL DIMENSIONS ARE IN MILLIMETERS.



DIMENSION "b" IS MEASURED AT THE MAXIMUM SOLDER BALL DIAMETER, PARALLEL TO PRIMARY DATUM **C**



PRIMARY DATUM **C** AND SEATING PLANE ARE DEFINED BY THE SPHERICAL CROWNS OF THE SOLDER BALLS.



BILATERAL TOLERANCE ZONE IS APPLIED TO EACH SIDE OF THE PACKAGE BODY.



EXACT SHAPE AND SIZE OF THIS FEATURE IS OPTIONAL.

SYMBOL	MIN.	NOM.	MAX.
A	-	-	1.76
A1	0.25	0.30	0.35
A2	0.80	-	-
D/E	17.00 BSC		
M/N	15.20 BSC		
S	0.40 BSC		
b	0.35	0.40	0.45
e	0.80 BSC		
aaa	-	-	0.15
bbb	-	-	0.20
ddd	-	-	0.12

388-Ball BGA Package

Dimensions in Millimeters

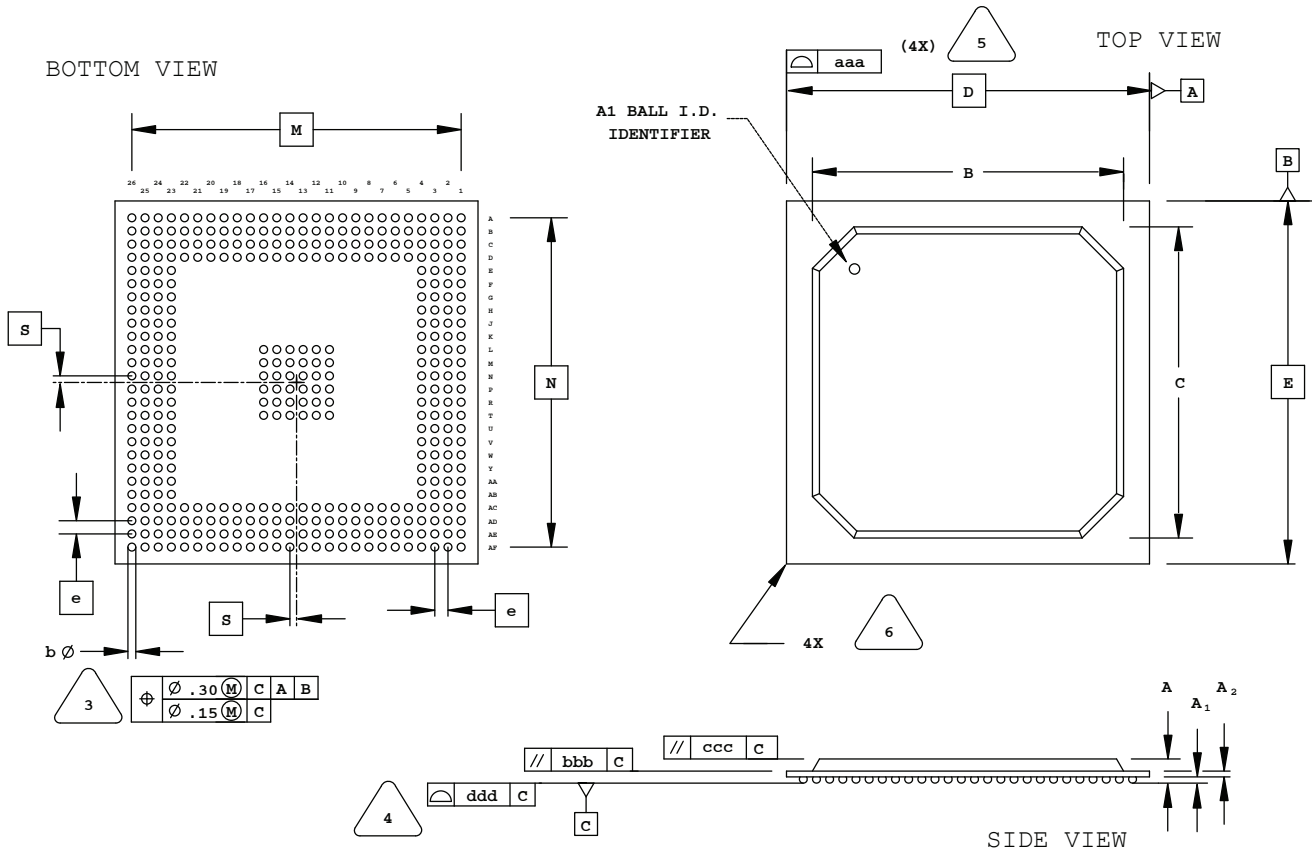

NOTES: UNLESS OTHERWISE SPECIFIED

- DIMENSIONS AND TOLERANCES PER ANSI Y14.5M.
- ALL DIMENSIONS ARE IN MILLIMETERS.



DIMENSION "b" IS MEASURED AT THE MAXIMUM SOLDER BALL DIAMETER, PARALLEL TO PRIMARY DATUM **C**



PRIMARY DATUM **C** AND SEATING PLANE ARE DEFINED BY THE SPHERICAL CROWNS OF THE SOLDER BALLS.



BILATERAL TOLERANCE ZONE IS APPLIED TO EACH SIDE OF THE PACKAGE BODY.



EXACT SHAPE AND SIZE OF THIS FEATURE IS OPTIONAL.

SYMBOL	MIN.	NOM.	MAX.
A	1.90	2.80	3.25
A1	0.50	0.65	0.80
A2	0.28	0.54	0.80
B/C	29.80	31.80	33.80
D/E	35.00 BSC		
M/N	31.75 BSC		
S	0.635 BSC		
b	0.60	0.75	0.90
e	1.27 BSC		
aaa	-	-	0.20
bbb	-	-	0.25
ccc	-	-	0.35
ddd	-	-	0.20

388-Ball fpBGA Package

Dimensions in Millimeters

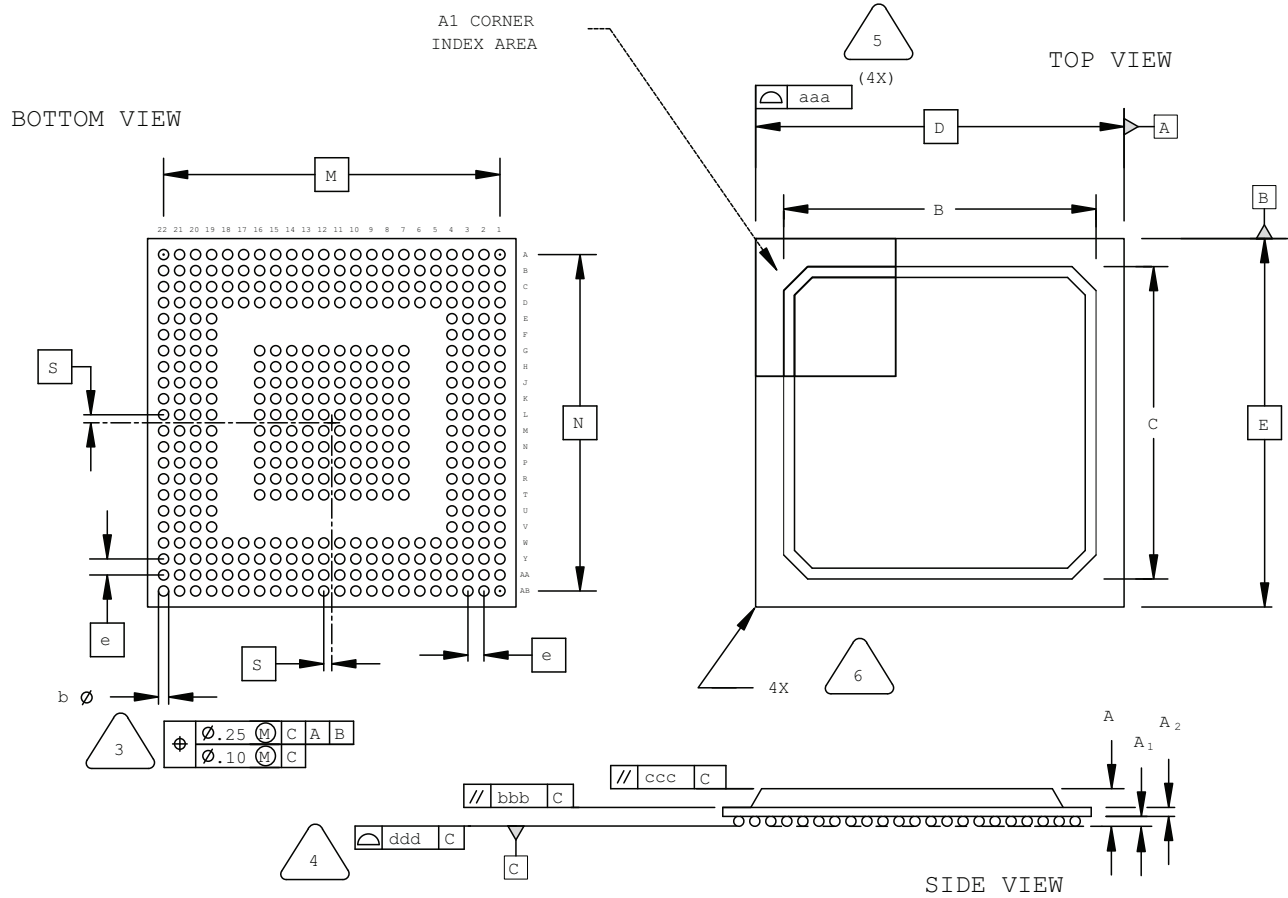

NOTES: UNLESS OTHERWISE SPECIFIED

- DIMENSIONS AND TOLERANCES PER ANSI Y14.5M.
- ALL DIMENSIONS ARE IN MILLIMETERS.



DIMENSION "b" IS MEASURED AT THE MAXIMUM SOLDER BALL DIAMETER, PARALLEL TO PRIMARY DATUM [C]



PRIMARY DATUM [C] AND SEATING PLANE ARE DEFINED BY THE SPHERICAL CROWNS OF THE SOLDER BALLS.



BILATERAL TOLERANCE ZONE IS APPLIED TO EACH SIDE OF THE PACKAGE BODY.



EXACT SHAPE AND SIZE OF THIS FEATURE IS OPTIONAL.

SYMBOL	MIN.	NOM.	MAX.
A	1.70	2.15	2.60
A1	0.30	0.50	0.70
A2	0.30	0.50	0.70
B/C	19.30	19.80	20.30
D/E	23.00 BSC		
M/N	21.00 BSC		
S	0.50 BSC		
b	0.50	0.60	0.70
e	1.00 BSC		
aaa	-	-	0.20
bbb	-	-	0.25
ccc	-	-	0.35
ddd	-	-	0.20

400-Ball caBGA Package

Dimensions in Millimeters

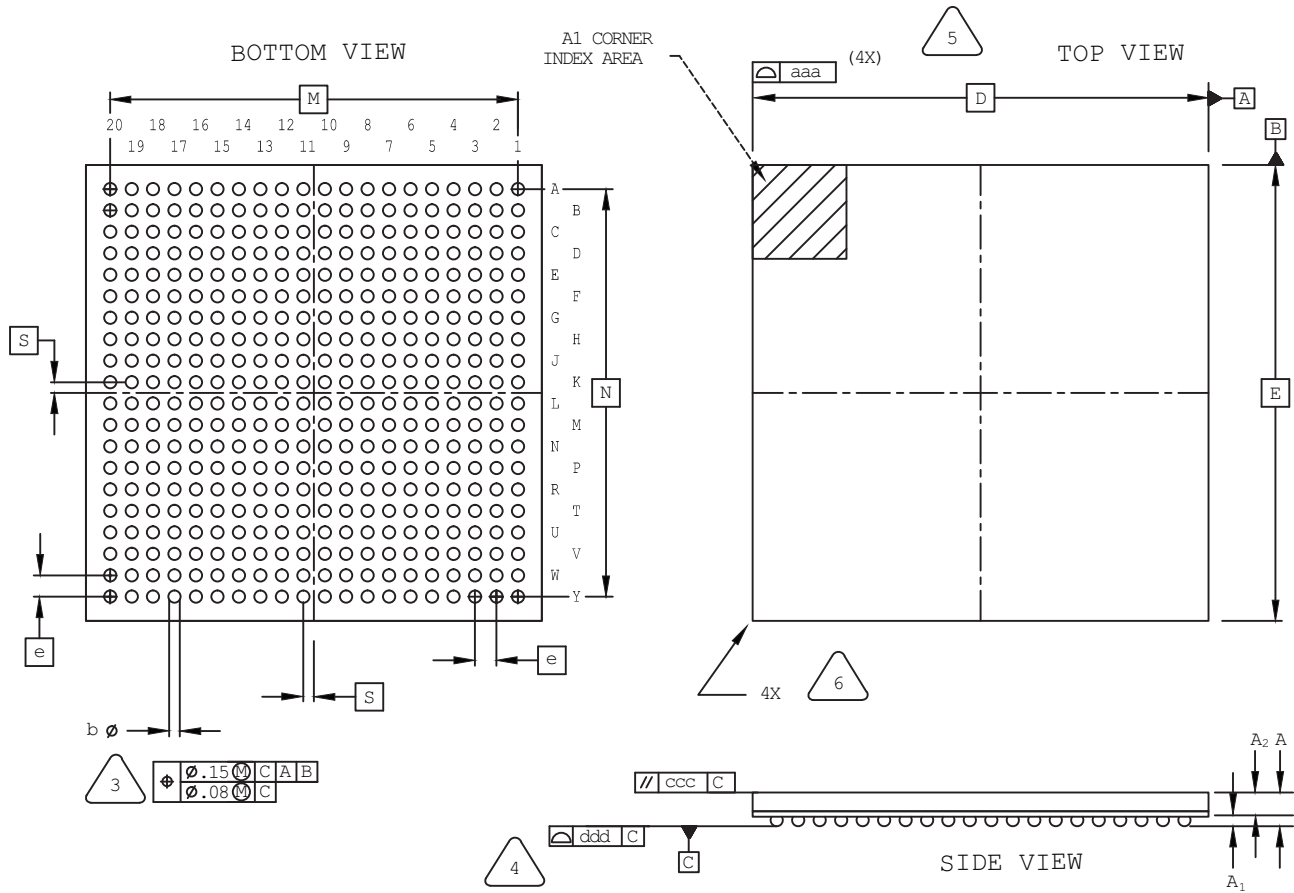

NOTES: UNLESS OTHERWISE SPECIFIED

1. DIMENSIONS AND TOLERANCES PER ANSI Y14.5M.
2. ALL DIMENSIONS ARE IN MILLIMETERS.



DIMENSION "b" IS MEASURED AT THE MAXIMUM SOLDER BALL DIAMETER, PARALLEL TO PRIMARY DATUM [C].



PRIMARY DATUM [C] AND SEATING PLANE ARE DEFINED BY THE SPHERICAL CROWNS OF THE SOLDER BALLS.



BILATERAL TOLERANCE ZONE IS APPLIED TO EACH SIDE OF THE PACKAGE BODY.



EXACT SHAPE AND SIZE OF THIS FEATURE IS OPTIONAL.

SYMBOL	MIN.	NOM.	MAX.
A	-	-	1.70
A1	0.25	0.35	-
A2	0.80	1.00	-
D/E	17.0 BSC		
M/N	15.2 BSC		
S	0.40 BSC		
b	0.40	0.45	0.50
e	0.80 BSC		
aaa	-	-	0.15
ccc	-	-	0.20
ddd	-	-	0.20

416-Ball fpBGA Package

Dimensions in Millimeters

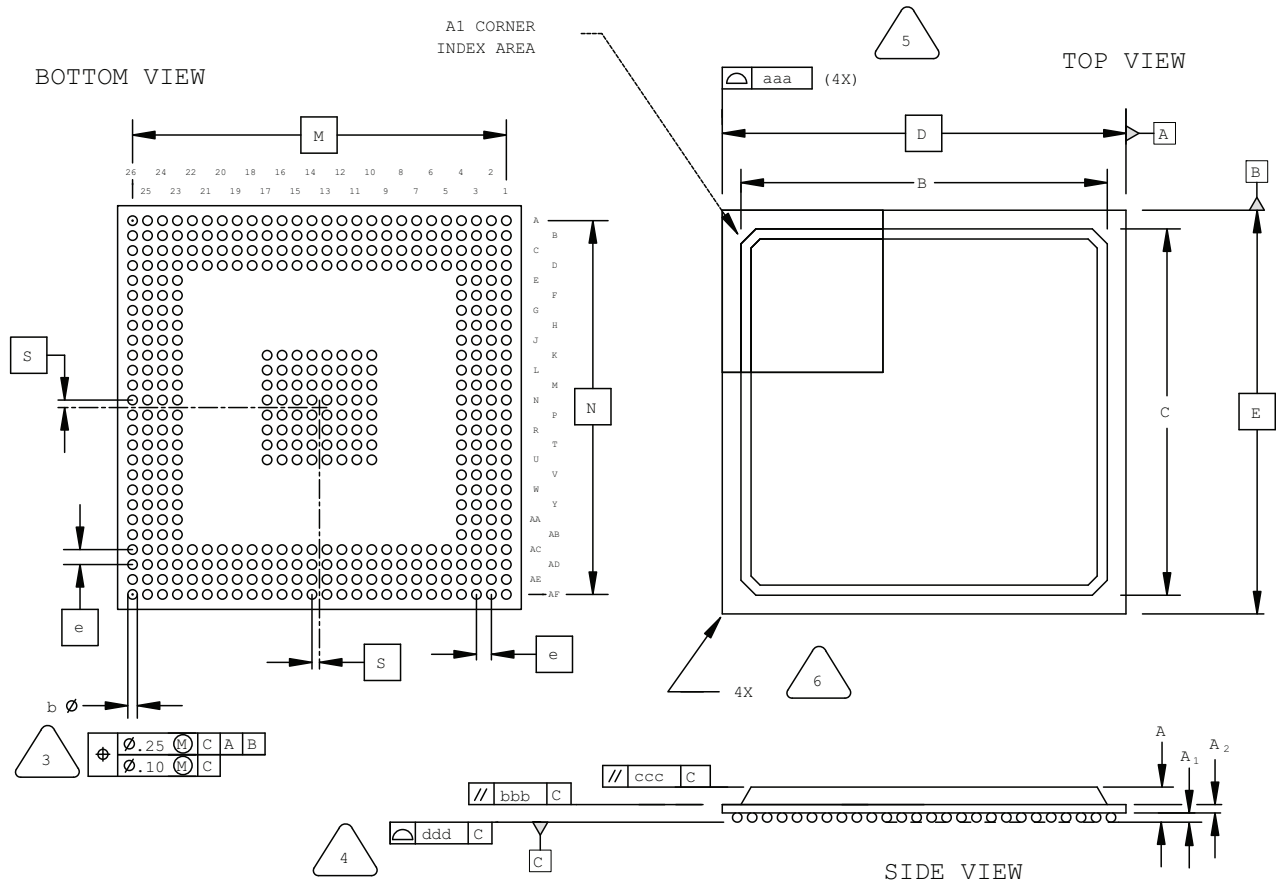

NOTES: UNLESS OTHERWISE SPECIFIED

- DIMENSIONS AND TOLERANCES PER ANSI Y14.5M.
- ALL DIMENSIONS ARE IN MILLIMETERS.

3 DIMENSION "b" IS MEASURED AT THE MAXIMUM SOLDER BALL DIAMETER, PARALLEL TO PRIMARY DATUM [C]

4 PRIMARY DATUM [C] AND SEATING PLANE ARE DEFINED BY THE SPHERICAL CROWNS OF THE SOLDER BALLS.

5 BILATERAL TOLERANCE ZONE IS APPLIED TO EACH SIDE OF THE PACKAGE BODY.

6 EXACT SHAPE AND SIZE OF THIS FEATURE IS OPTIONAL.

SYMBOL	MIN.	NOM.	MAX.
A	1.70	2.15	2.60
A1	0.30	0.50	0.70
A2	0.30	0.50	0.70
B/C	23.80	24.80	25.80
D/E	27.00 BSC		
M/N	25.00 BSC		
S	0.50 BSC		
b	0.50	0.60	0.70
e	1.00 BSC		
aaa	-	-	0.20
bbb	-	-	0.25
ccc	-	-	0.35
ddd	-	-	0.20

432-Ball SBGA Package

Dimensions in Millimeters

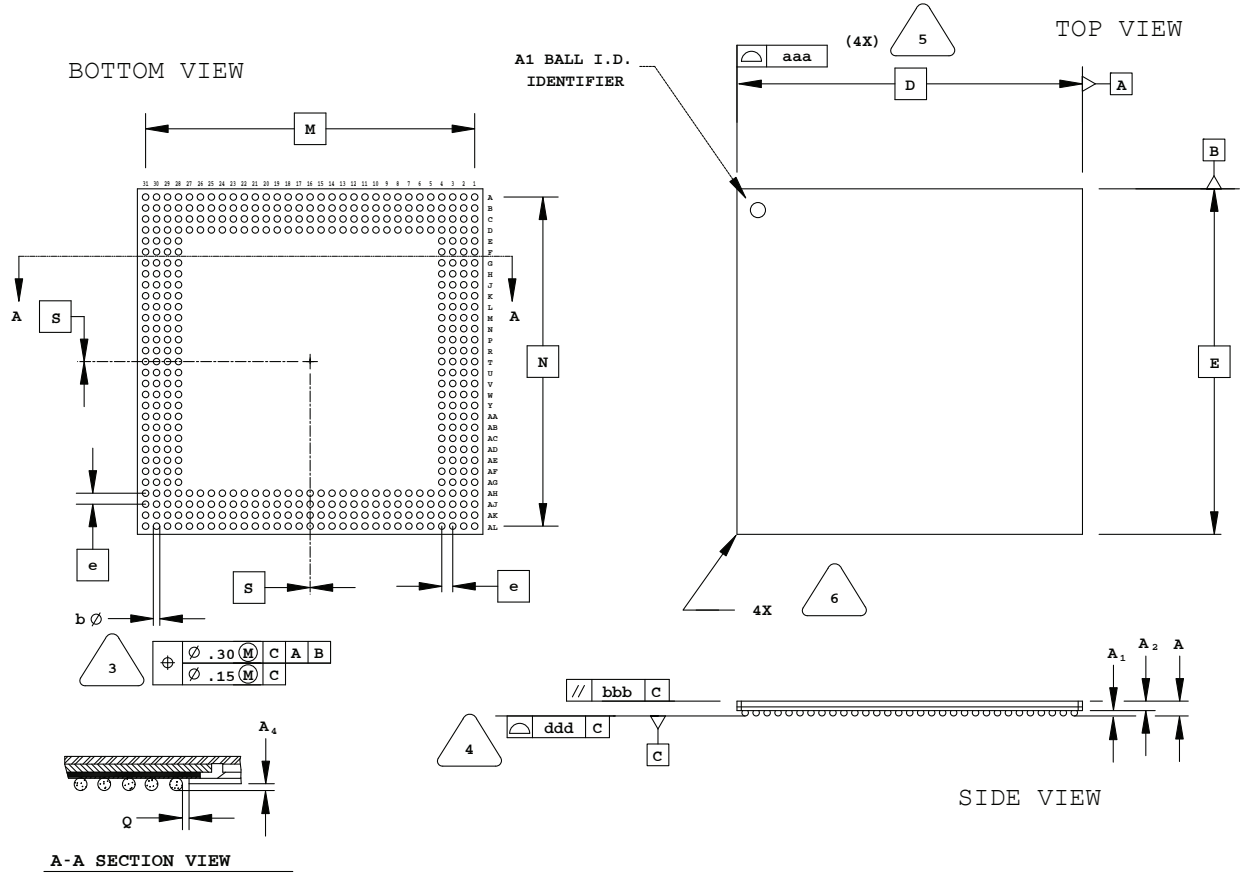

NOTES: UNLESS OTHERWISE SPECIFIED

- DIMENSIONS AND TOLERANCES PER ANSI Y14.5M.
- ALL DIMENSIONS ARE IN MILLIMETERS.

- 3 DIMENSION "b" IS MEASURED AT THE MAXIMUM SOLDER BALL DIAMETER, PARALLEL TO PRIMARY DATUM C
- 4 PRIMARY DATUM C AND SEATING PLANE ARE DEFINED BY THE SPHERICAL CROWNS OF THE SOLDER BALLS.
- 5 BILATERAL TOLERANCE ZONE IS APPLIED TO EACH SIDE OF THE PACKAGE BODY.
- 6 EXACT SHAPE AND SIZE OF THIS FEATURE IS OPTIONAL.

SYMBOL	MIN.	NOM.	MAX.
A	-	-	1.70
A1	0.50	0.65	0.80
A2	0.80	0.90	1.00
D/E	40.00 BSC		
M/N	38.10 BSC		
S	0.00 BSC		
b	0.60	0.75	0.90
e	1.27 BSC		
Q	0.25	-	-
A4	0.10	-	-
aaa	-	-	0.20
bbb	-	-	0.25
ddd	-	-	0.20

484-Ball fpBGA Package

Dimensions in Millimeters

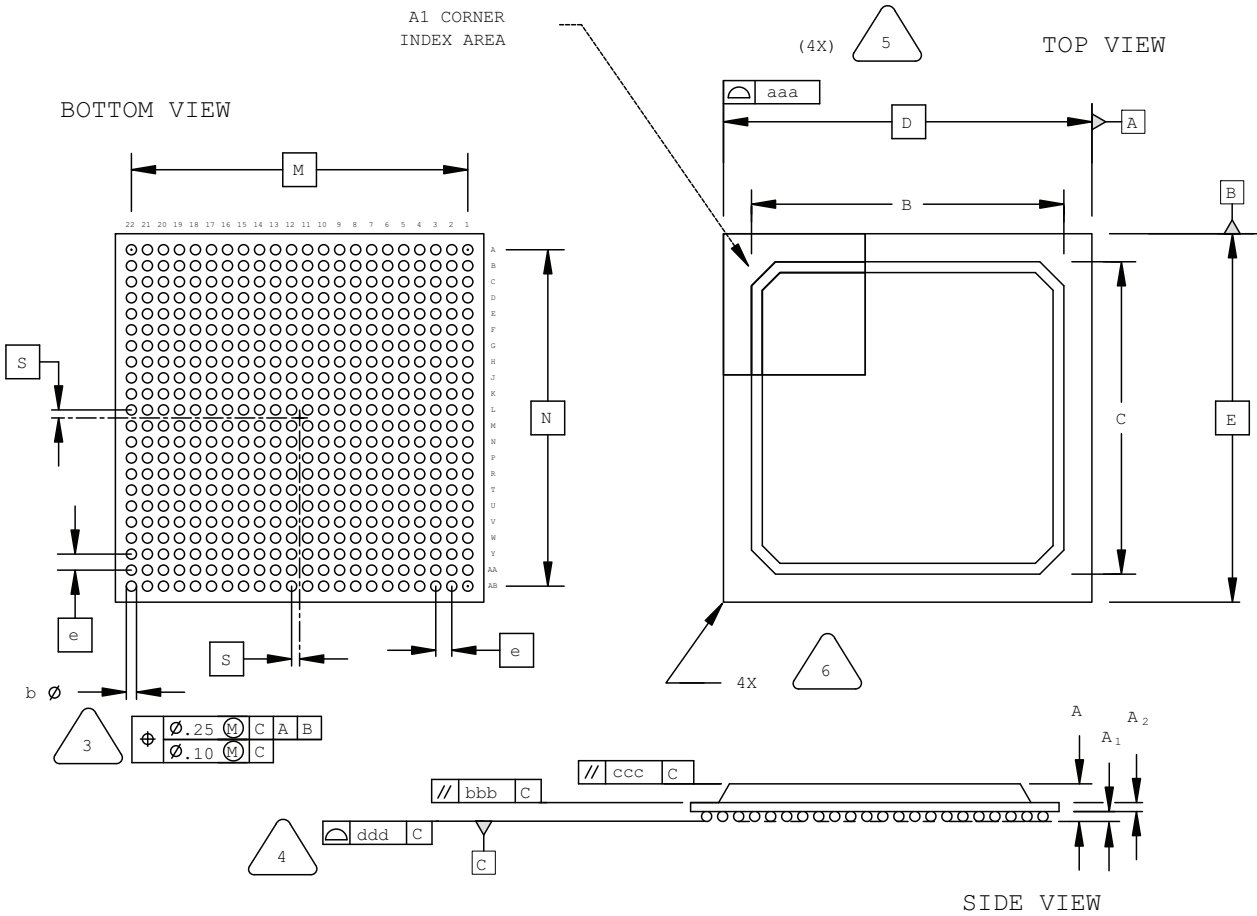

NOTES: UNLESS OTHERWISE SPECIFIED

- DIMENSIONS AND TOLERANCES PER ANSI Y14.5M.
- ALL DIMENSIONS ARE IN MILLIMETERS.

- 3 DIMENSION "b" IS MEASURED AT THE MAXIMUM SOLDER BALL DIAMETER, PARALLEL TO PRIMARY DATUM \square C
- 4 PRIMARY DATUM \square C AND SEATING PLANE ARE DEFINED BY THE SPHERICAL CROWNS OF THE SOLDER BALLS.
- 5 BILATERAL TOLERANCE ZONE IS APPLIED TO EACH SIDE OF THE PACKAGE BODY.
- 6 EXACT SHAPE AND SIZE OF THIS FEATURE IS OPTIONAL.

SYMBOL	MIN.	NOM.	MAX.
A	1.70	2.15	2.60
A1	0.30	0.50	0.70
A2	0.30	0.50	0.70
B/C	19.30	19.80	20.30
D/E	23.00 BSC		
M/N	21.00 BSC		
S	0.50 BSC		
b	0.50	0.60	0.70
e	1.00 BSC		
aaa	-	-	0.20
bbb	-	-	0.25
ccc	-	-	0.35
ddd	-	-	0.20

516-Ball fpBGA Package

Dimensions in Millimeters

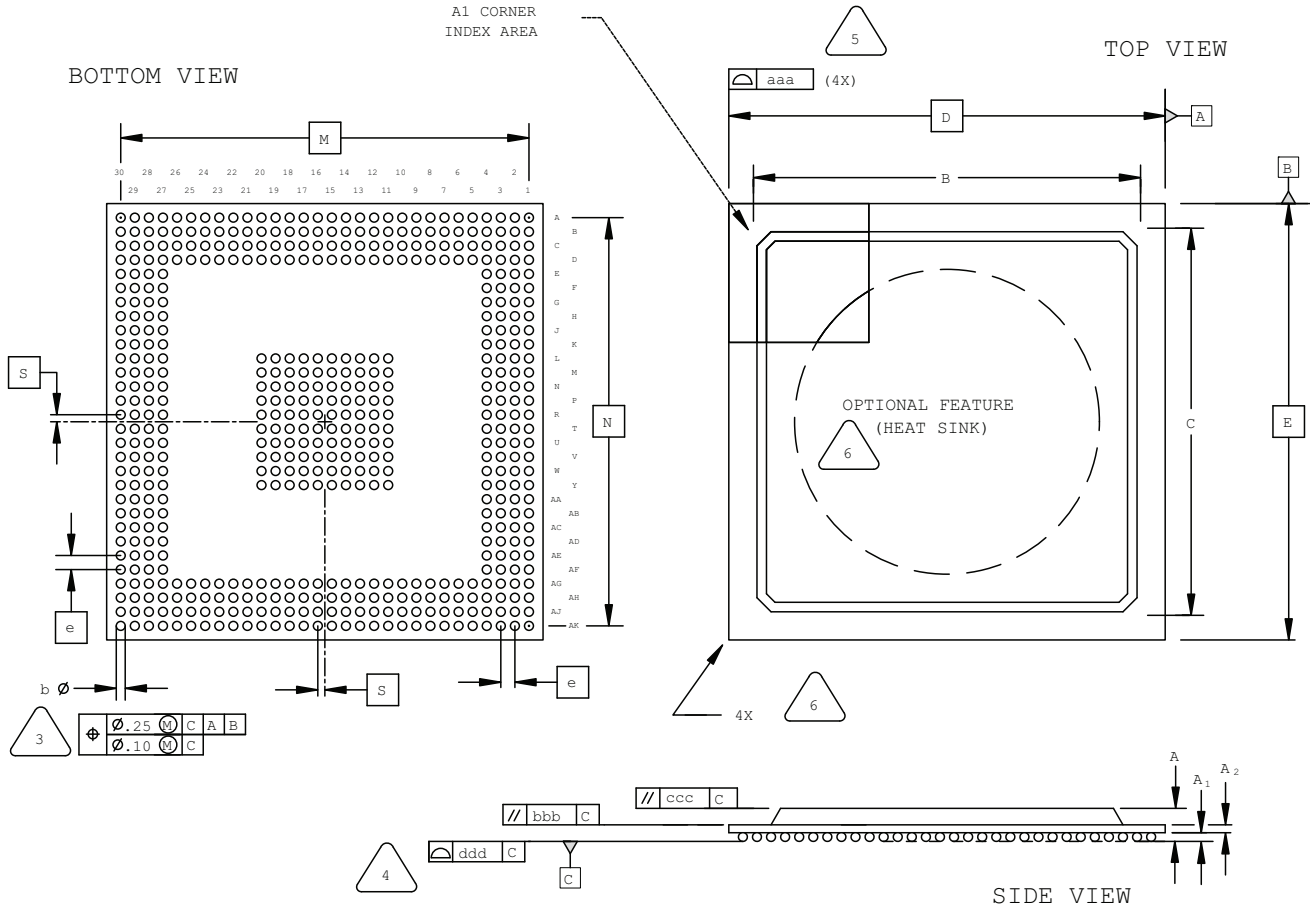

NOTES: UNLESS OTHERWISE SPECIFIED

- DIMENSIONS AND TOLERANCES PER ANSI Y14.5M.
- ALL DIMENSIONS ARE IN MILLIMETERS.



DIMENSION "b" IS MEASURED AT THE MAXIMUM SOLDER BALL DIAMETER, PARALLEL TO PRIMARY DATUM [C]



PRIMARY DATUM [C] AND SEATING PLANE ARE DEFINED BY THE SPHERICAL CROWNS OF THE SOLDER BALLS.



BILATERAL TOLERANCE ZONE IS APPLIED TO EACH SIDE OF THE PACKAGE BODY.



EXACT SHAPE AND SIZE OF THIS FEATURE IS OPTIONAL.

SYMBOL	MIN.	NOM.	MAX.
A	1.70	2.15	2.60
A1	0.30	0.50	0.70
A2	0.30	0.50	0.70
B/C	25.80	27.55	29.30
D/E	31.00 BSC		
M/N	29.00 BSC		
S	0.50 BSC		
b	0.50	0.60	0.70
e	1.00 BSC		
aaa	-	-	0.20
bbb	-	-	0.25
ccc	-	-	0.35
ddd	-	-	0.20

554-Ball caBGA Package

Dimensions in Millimeters

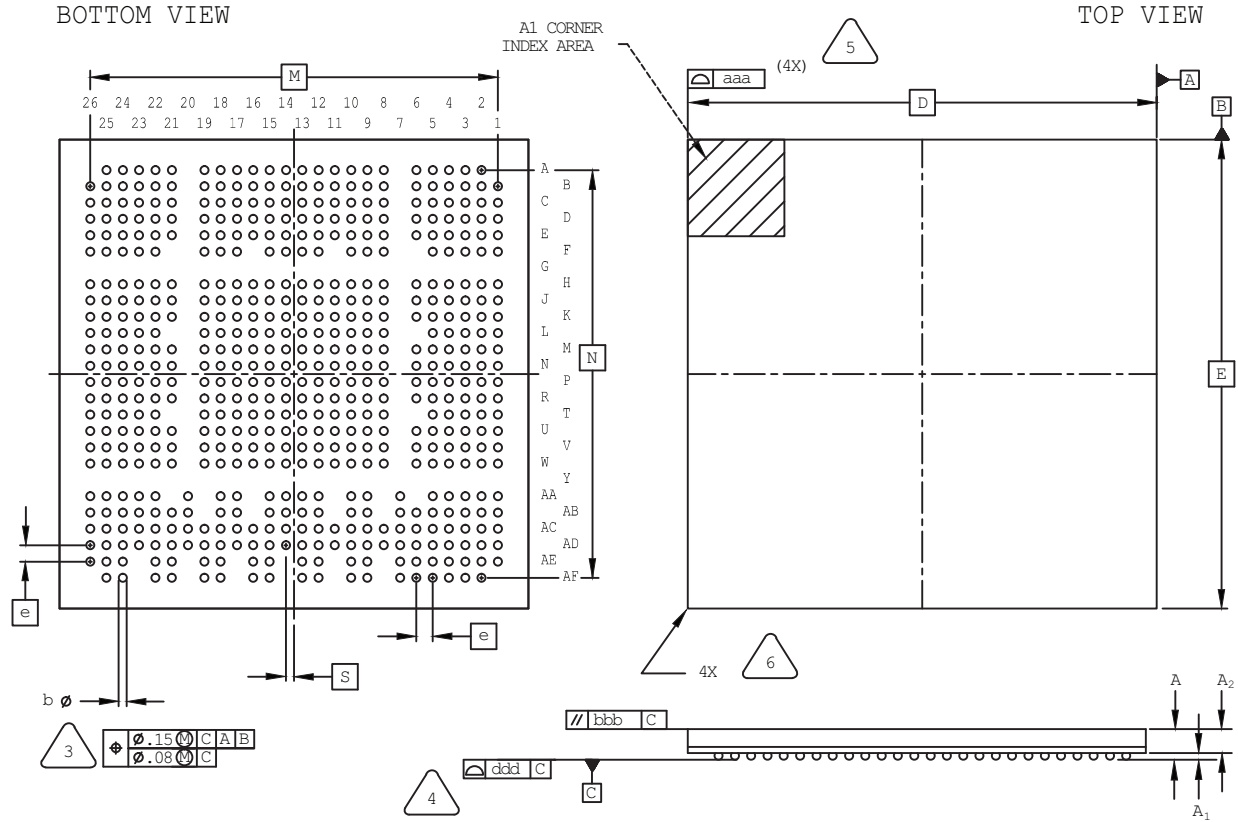

NOTES: UNLESS OTHERWISE SPECIFIED

1. DIMENSIONS AND TOLERANCES PER ANSI Y14.5M.
2. ALL DIMENSIONS ARE IN MILLIMETERS.

- 3. DIMENSION "b" IS MEASURED AT THE MAXIMUM SOLDER BALL DIAMETER, PARALLEL TO PRIMARY DATUM [C]
- 4. PRIMARY DATUM [C] AND SEATING PLANE ARE DEFINED BY THE SPHERICAL CROWNS OF THE SOLDER BALLS.
- 5. BILATERAL TOLERANCE ZONE IS APPLIED TO EACH SIDE OF THE PACKAGE BODY.
- 6. EXACT SHAPE AND SIZE OF THIS FEATURE IS OPTIONAL.

SYMBOL	MIN.	NOM.	MAX.
A	-	-	1.76
A1	0.25	0.30	0.35
A2	0.80	-	-
D/E	23.0 BSC		
M/N	20.0 BSC		
S	0.40 BSC		
b	0.35	0.40	0.45
e	0.80 BSC		
aaa	-	-	0.15
bbb	-	-	0.20
ddd	-	-	0.12

672-Ball fpBGA Package

Dimensions in Millimeters

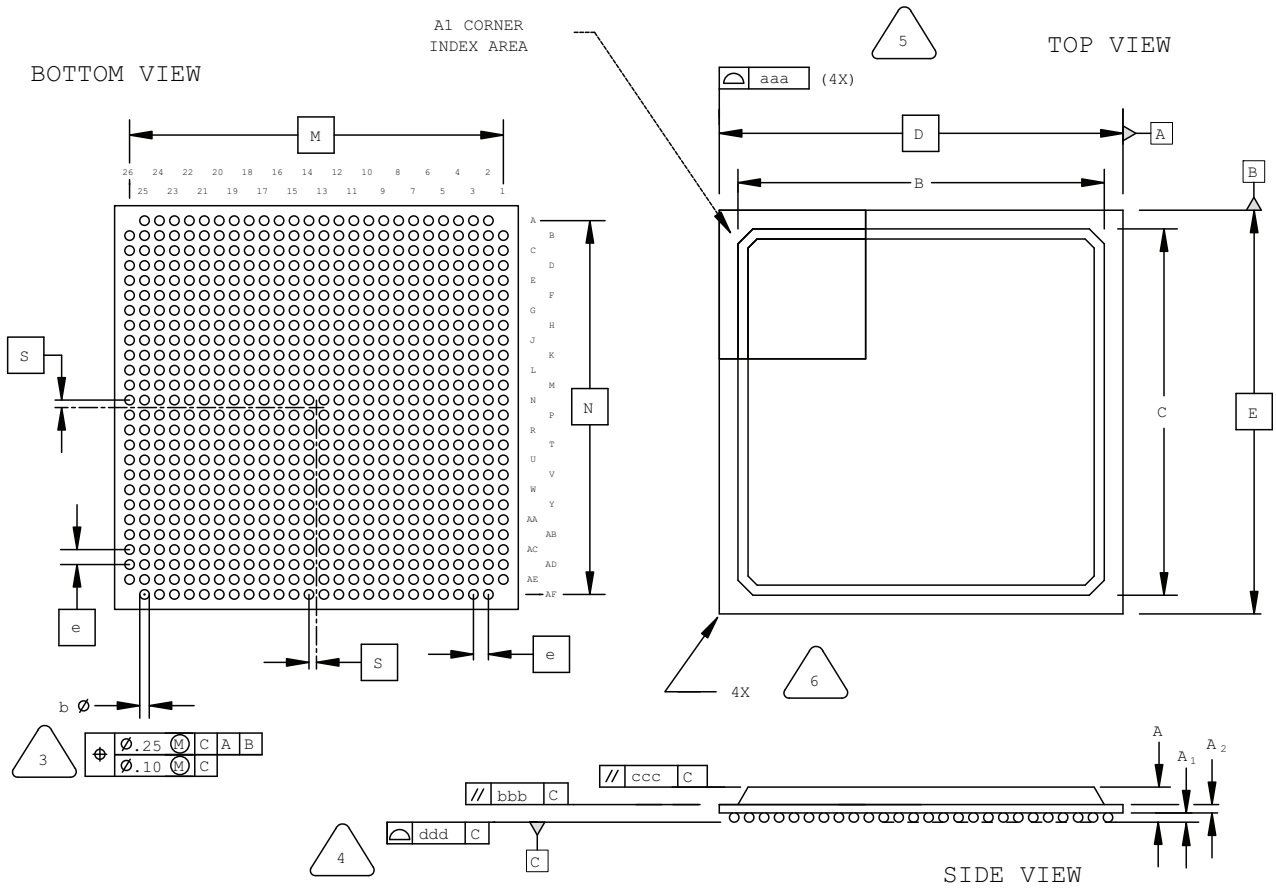

NOTES: UNLESS OTHERWISE SPECIFIED

- DIMENSIONS AND TOLERANCES PER ANSI Y14.5M.
- ALL DIMENSIONS ARE IN MILLIMETERS.

3 DIMENSION "b" IS MEASURED AT THE MAXIMUM SOLDER BALL DIAMETER, PARALLEL TO PRIMARY DATUM \square C

4 PRIMARY DATUM \square C AND SEATING PLANE ARE DEFINED BY THE SPHERICAL CROWNS OF THE SOLDER BALLS.

5 BILATERAL TOLERANCE ZONE IS APPLIED TO EACH SIDE OF THE PACKAGE BODY.

6 EXACT SHAPE AND SIZE OF THIS FEATURE IS OPTIONAL.

SYMBOL	MIN.	NOM.	MAX.
A	1.70	2.15	2.60
A1	0.30	0.50	0.70
A2	0.30	0.50	0.70
B/C	23.80	24.80	25.80
D/E	27.00 BSC		
M/N	25.00 BSC		
S	0.50 BSC		
b	0.50	0.60	0.70
e	1.00 BSC		
aaa	-	-	0.20
bbb	-	-	0.25
ccc	-	-	0.35
ddd	-	-	0.20

676-Ball fpBGA Package

Dimensions in Millimeters

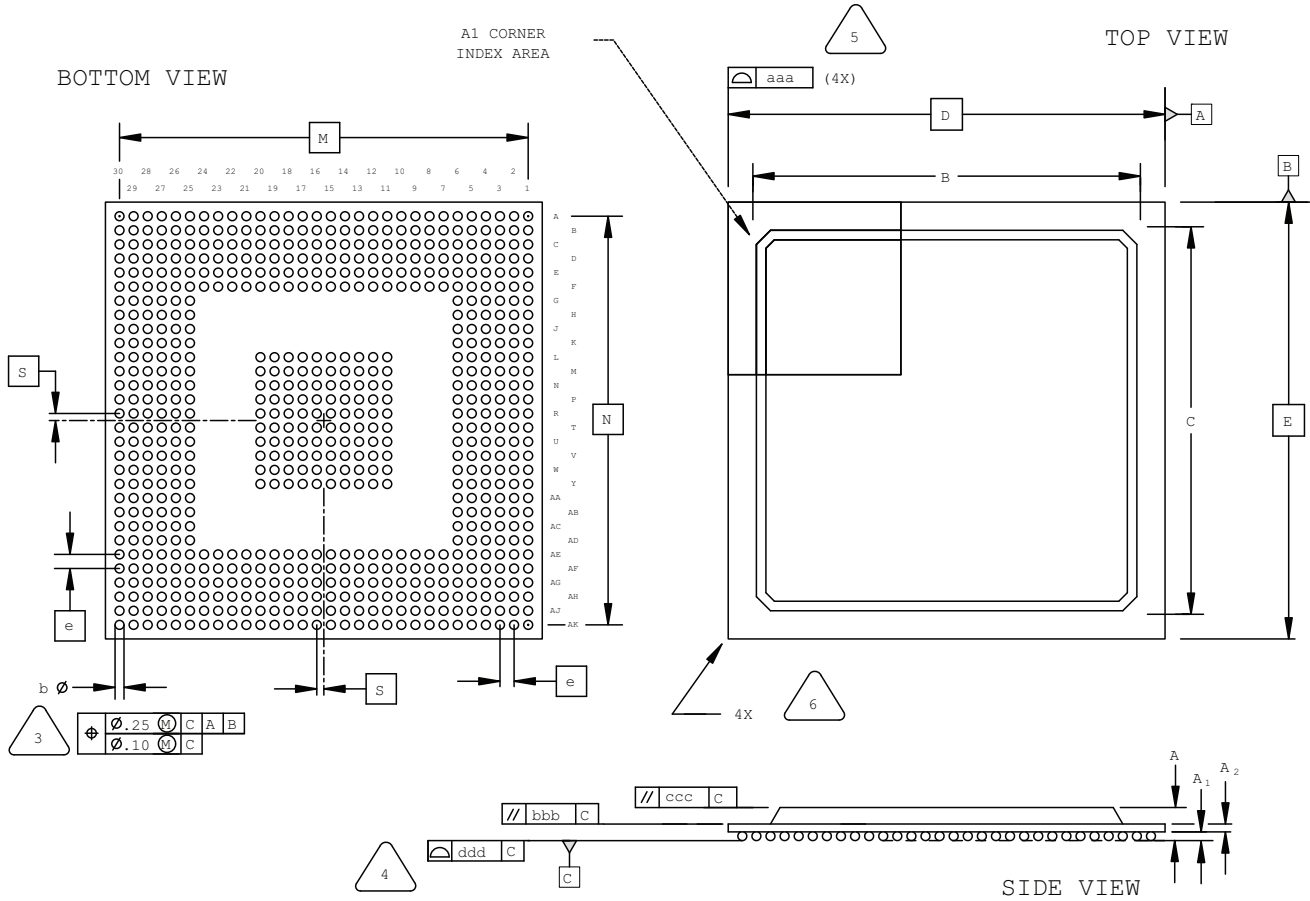

NOTES: UNLESS OTHERWISE SPECIFIED

1. DIMENSIONS AND TOLERANCES PER ANSI Y14.5M.
2. ALL DIMENSIONS ARE IN MILLIMETERS.



DIMENSION "b" IS MEASURED AT THE MAXIMUM SOLDER BALL DIAMETER, PARALLEL TO PRIMARY DATUM $\square C$



PRIMARY DATUM $\square C$ AND SEATING PLANE ARE DEFINED BY THE SPHERICAL CROWNS OF THE SOLDER BALLS.



BILATERAL TOLERANCE ZONE IS APPLIED TO EACH SIDE OF THE PACKAGE BODY.



EXACT SHAPE AND SIZE OF THIS FEATURE IS OPTIONAL.

SYMBOL	MIN.	NOM.	MAX.
A	1.70	2.15	2.60
A1	0.30	0.50	0.70
A2	0.30	0.50	0.70
B/C	25.80	27.55	29.30
D/E	31.00 BSC		
M/N	29.00 BSC		
S	0.50 BSC		
b	0.50	0.60	0.70
e	1.00 BSC		
aaa	-	-	0.20
bbb	-	-	0.25
ccc	-	-	0.35
ddd	-	-	0.20

676-Ball fcBGA Package

Dimensions in Millimeters

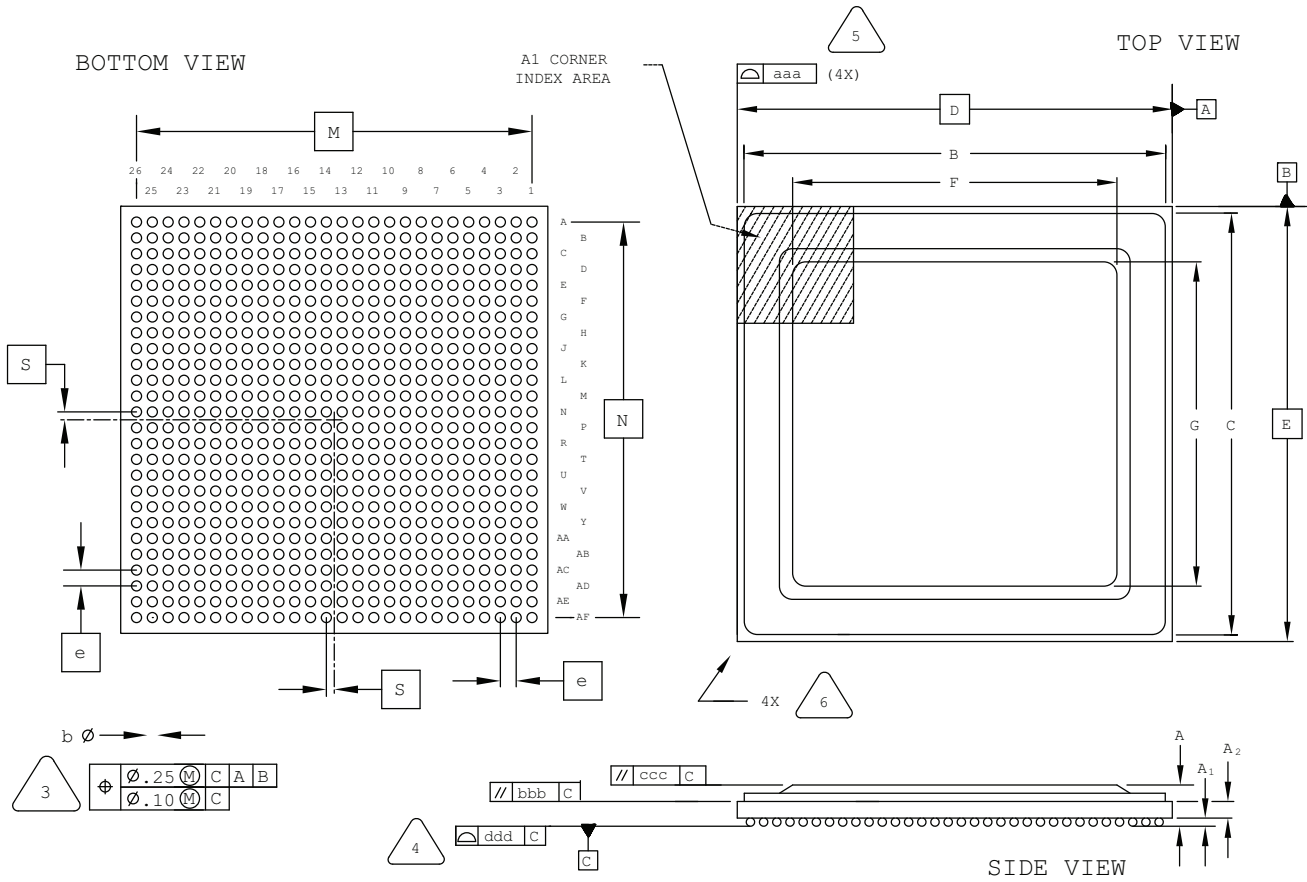

NOTES: UNLESS OTHERWISE SPECIFIED

1. DIMENSIONS AND TOLERANCES PER ANSI Y14.5M.
2. ALL DIMENSIONS ARE IN MILLIMETERS.



DIMENSION "b" IS MEASURED AT THE MAXIMUM SOLDER BALL DIAMETER, PARALLEL TO PRIMARY DATUM [C]



PRIMARY DATUM [C] AND SEATING PLANE ARE DEFINED BY THE SPHERICAL CROWNS OF THE SOLDER BALLS.



BILATERAL TOLERANCE ZONE IS APPLIED TO EACH SIDE OF THE PACKAGE BODY.



EXACT SHAPE AND SIZE OF THIS FEATURE IS OPTIONAL.

SYMBOL	MIN.	NOM.	MAX.
A	2.55	2.90	3.25
A1	0.40	0.50	0.60
A2	1.20 REF		
B/C	26.55	26.60	26.65
D/E	27.00 BSC		
F/G	18.55	18.60	18.65
M/N	25.00 BSC		
S	0.50 BSC		
b	0.50	0.60	0.70
e	1.00 BSC		
aaa	-	-	0.20
bbb	-	-	0.25
ccc	-	-	0.35
ddd	-	-	0.20

680-Ball fpBGA Package

(with or without Internal Heat Spreader)
Dimensions in Millimeters

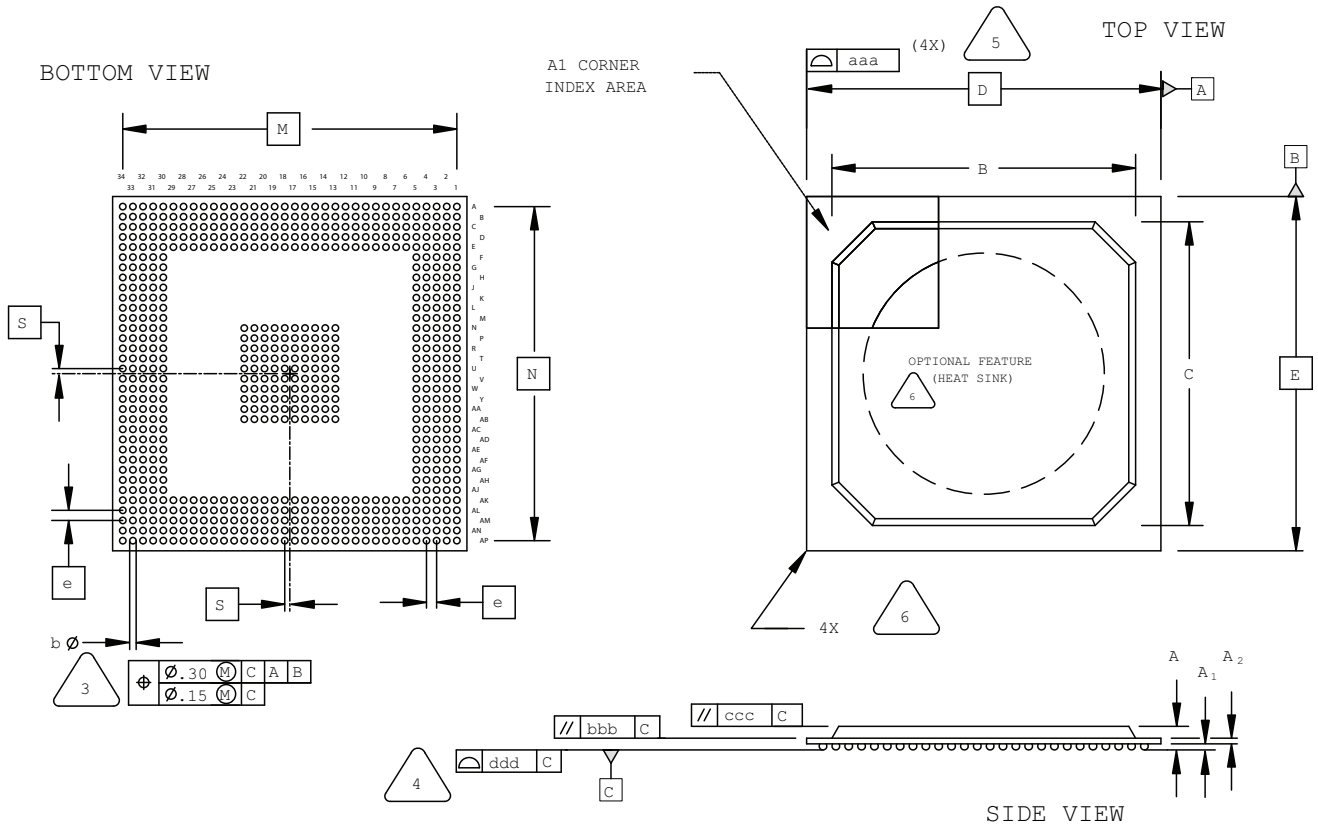

NOTES: UNLESS OTHERWISE SPECIFIED

- DIMENSIONS AND TOLERANCES PER ANSI Y14.5M.
- ALL DIMENSIONS ARE IN MILLIMETERS.



DIMENSION "b" IS MEASURED AT THE MAXIMUM SOLDER BALL DIAMETER, PARALLEL TO PRIMARY DATUM $\square C$



PRIMARY DATUM $\square C$ AND SEATING PLANE ARE DEFINED BY THE SPHERICAL CROWNS OF THE SOLDER BALLS.



BILATERAL TOLERANCE ZONE IS APPLIED TO EACH SIDE OF THE PACKAGE BODY.



EXACT SHAPE AND SIZE OF THIS FEATURE IS OPTIONAL.

SYMBOL	MIN.	NOM.	MAX.
A	1.90	2.25	2.60
A1	0.30	0.50	0.70
A2	0.40	0.60	0.80
B/C	29.80	30.30	30.80
D/E	35.00 BSC		
M/N	33.00 BSC		
S	0.50 BSC		
b	0.50	0.60	0.70
e	1.00 BSC		
aaa	-	-	0.20
bbb	-	-	0.25
ccc	-	-	0.35
ddd	-	-	0.20

680-Ball fpSBGA Package

Dimensions in Millimeters

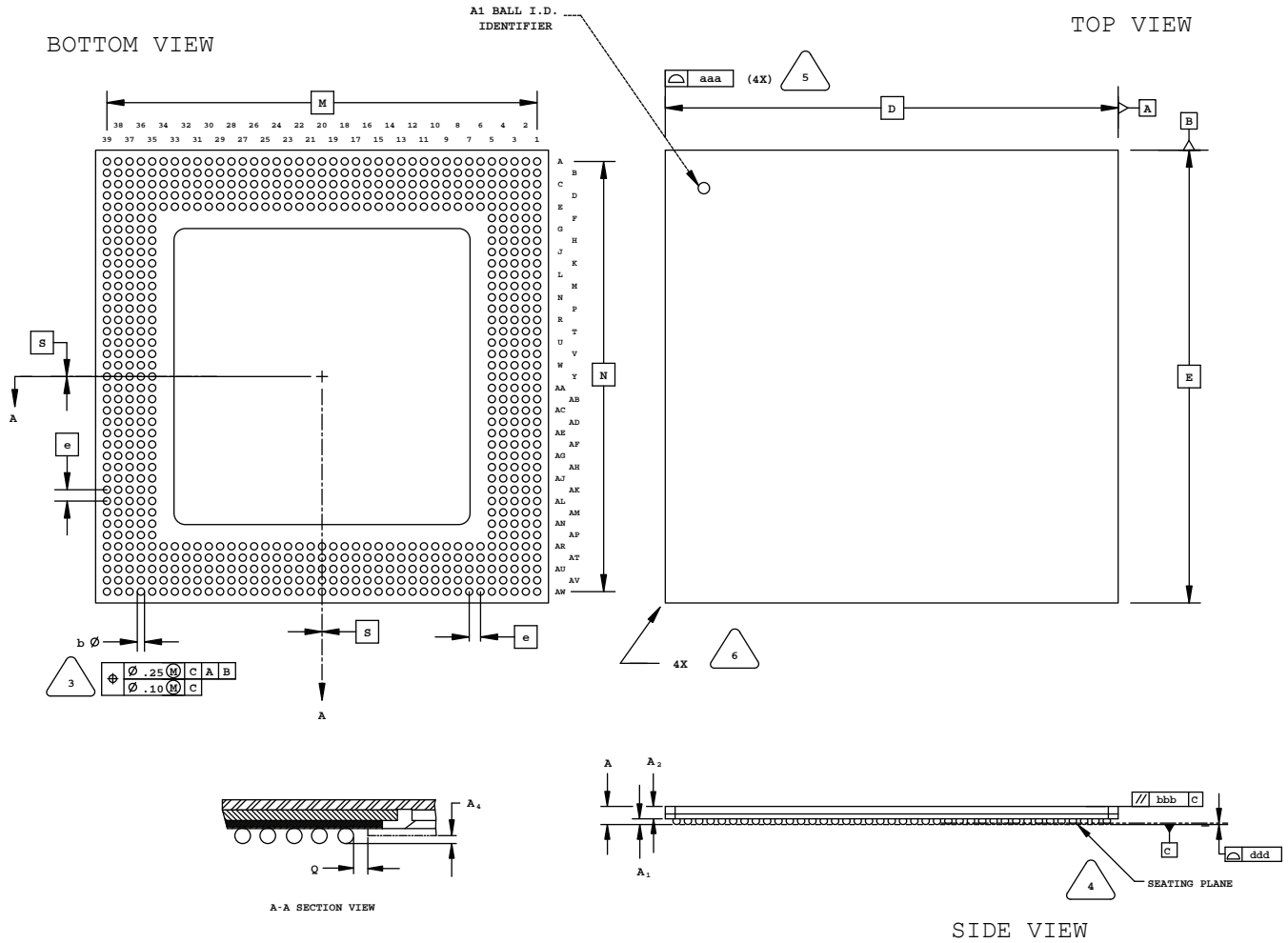

SYMBOL	MIN.	NOM.	MAX.
A	-	-	1.70
A1	0.45	0.53	0.60
A2	0.90	0.98	1.05
D/E	40.00 BSC		
M/N	38.00 BSC		
S	0.00 BSC		
b	0.50	0.65	0.80
e	1.00 BSC		
Q	0.25	-	-
A4	0.10	-	-
aaa	-	-	0.20
bbb	-	-	0.25
ddd	-	-	0.20

756-Ball caBGA Package

Dimensions in Millimeters

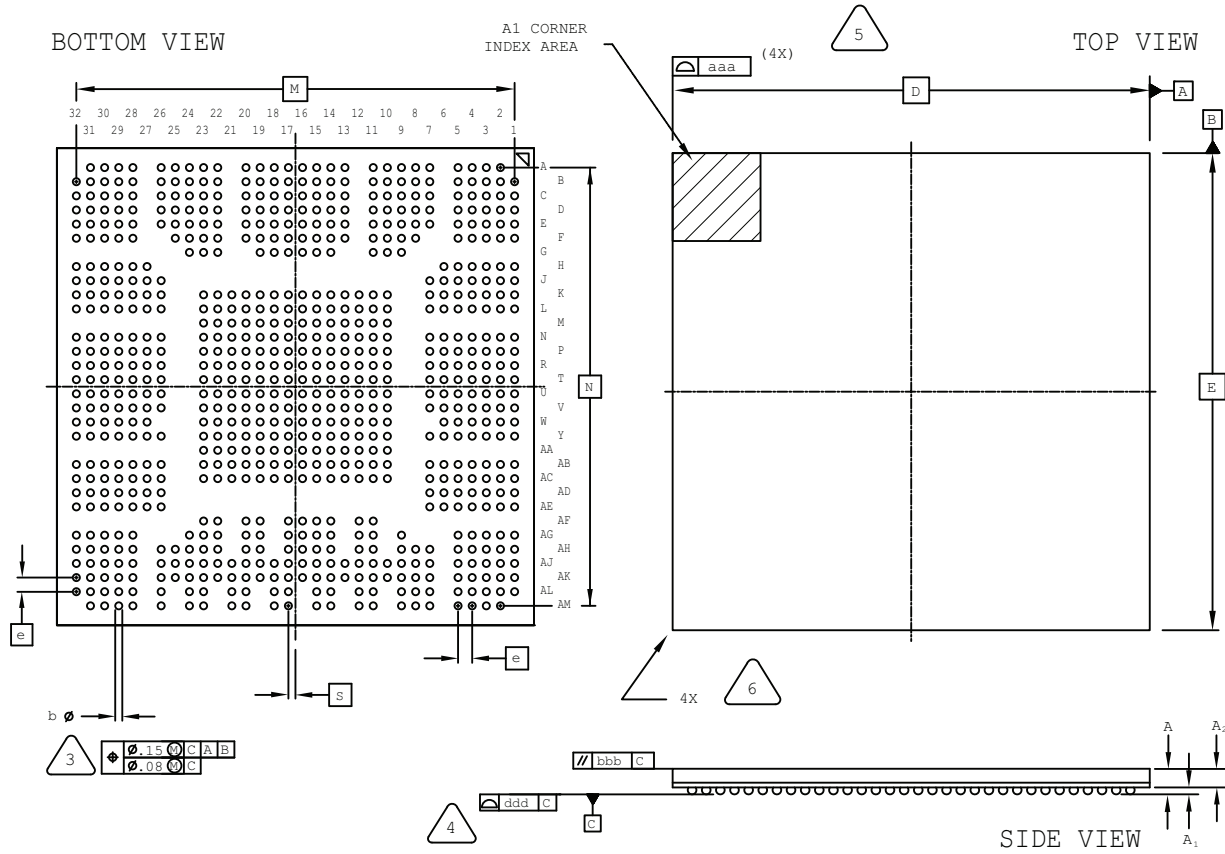

NOTES: UNLESS OTHERWISE SPECIFIED

1. DIMENSIONS AND TOLERANCES PER ANSI Y14.5M.
2. ALL DIMENSIONS ARE IN MILLIMETERS.

3. DIMENSION "b" IS MEASURED AT THE MAXIMUM SOLDER BALL DIAMETER, PARALLEL TO PRIMARY DATUM [C].
4. PRIMARY DATUM [C] AND SEATING PLANE ARE DEFINED BY THE SPHERICAL CROWNS OF THE SOLDER BALLS.
5. BILATERAL TOLERANCE ZONE IS APPLIED TO EACH SIDE OF THE PACKAGE BODY.
6. EXACT SHAPE AND SIZE OF THIS FEATURE IS OPTIONAL.

SYMBOL	MIN.	NOM.	MAX.
A	-	-	1.76
A1	0.25	0.30	0.35
A2	0.80	-	-
D/E	27.00 BSC		
M/N	24.80 BSC		
S	0.40 BSC		
b	0.35	0.40	0.45
e	0.80 BSC		
aaa	-	-	0.15
bbb	-	-	0.20
ddd	-	-	0.12

900-Ball fpBGA Package

Dimensions in Millimeters

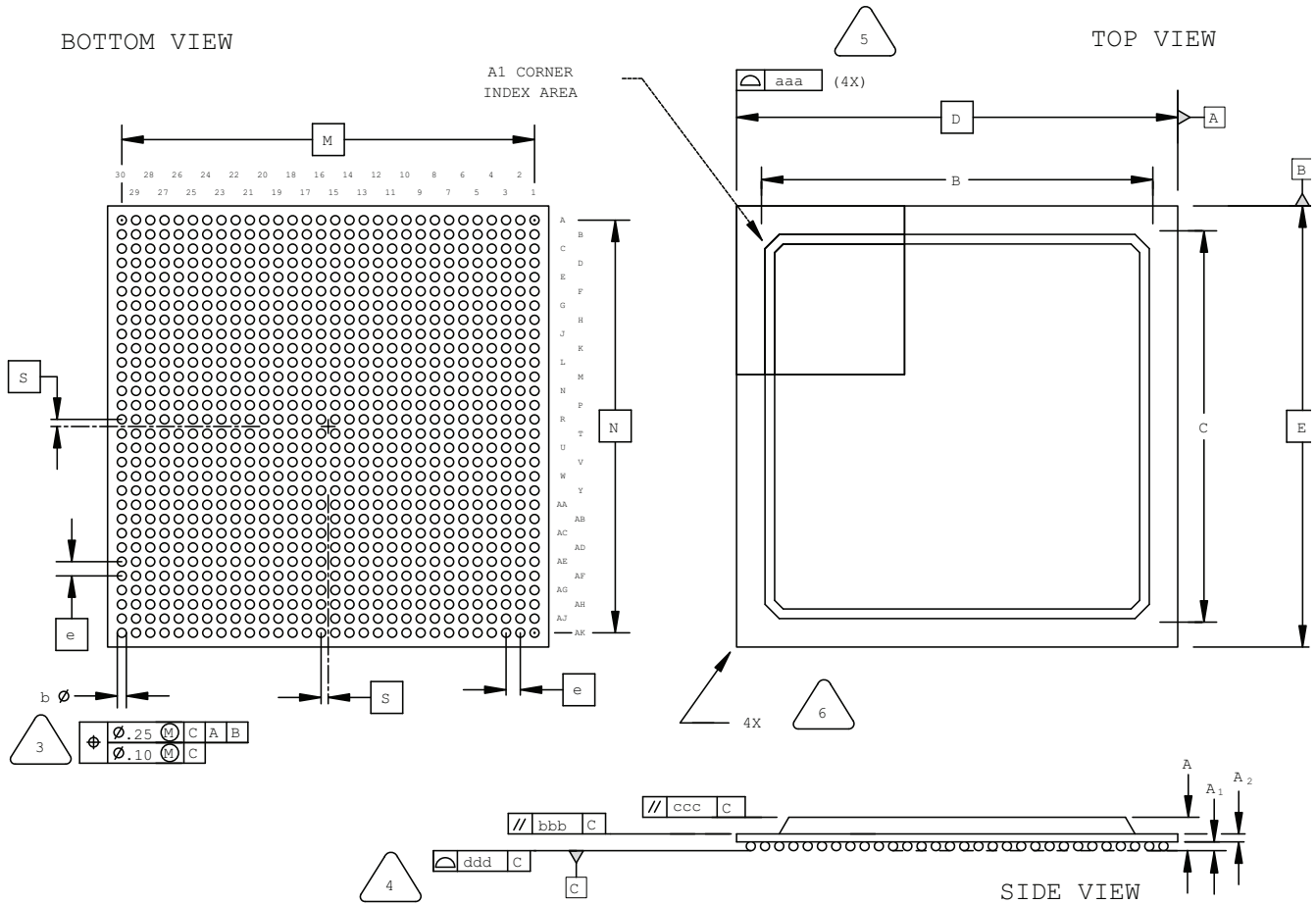

NOTES: UNLESS OTHERWISE SPECIFIED

1. DIMENSIONS AND TOLERANCES PER ANSI Y14.5M.
2. ALL DIMENSIONS ARE IN MILLIMETERS.



DIMENSION "b" IS MEASURED AT THE MAXIMUM SOLDER BALL DIAMETER, PARALLEL TO PRIMARY DATUM **C**.



PRIMARY DATUM **C** AND SEATING PLANE ARE DEFINED BY THE SPHERICAL CROWNS OF THE SOLDER BALLS.



BILATERAL TOLERANCE ZONE IS APPLIED TO EACH SIDE OF THE PACKAGE BODY.



EXACT SHAPE AND SIZE OF THIS FEATURE IS OPTIONAL.

SYMBOL	MIN.	NOM.	MAX.
A	1.70	2.15	2.60
A1	0.30	0.50	0.70
A2	0.30	0.50	0.70
B/C	25.80	27.55	29.30
D/E	31.00 BSC		
M/N	29.00 BSC		
S	0.50 BSC		
b	0.50	0.60	0.70
e	1.00 BSC		
aaa	-	-	0.20
bbb	-	-	0.25
ccc	-	-	0.35
ddd	-	-	0.20

1020-Ball Organic fcBGA Package

Dimensions in Millimeters

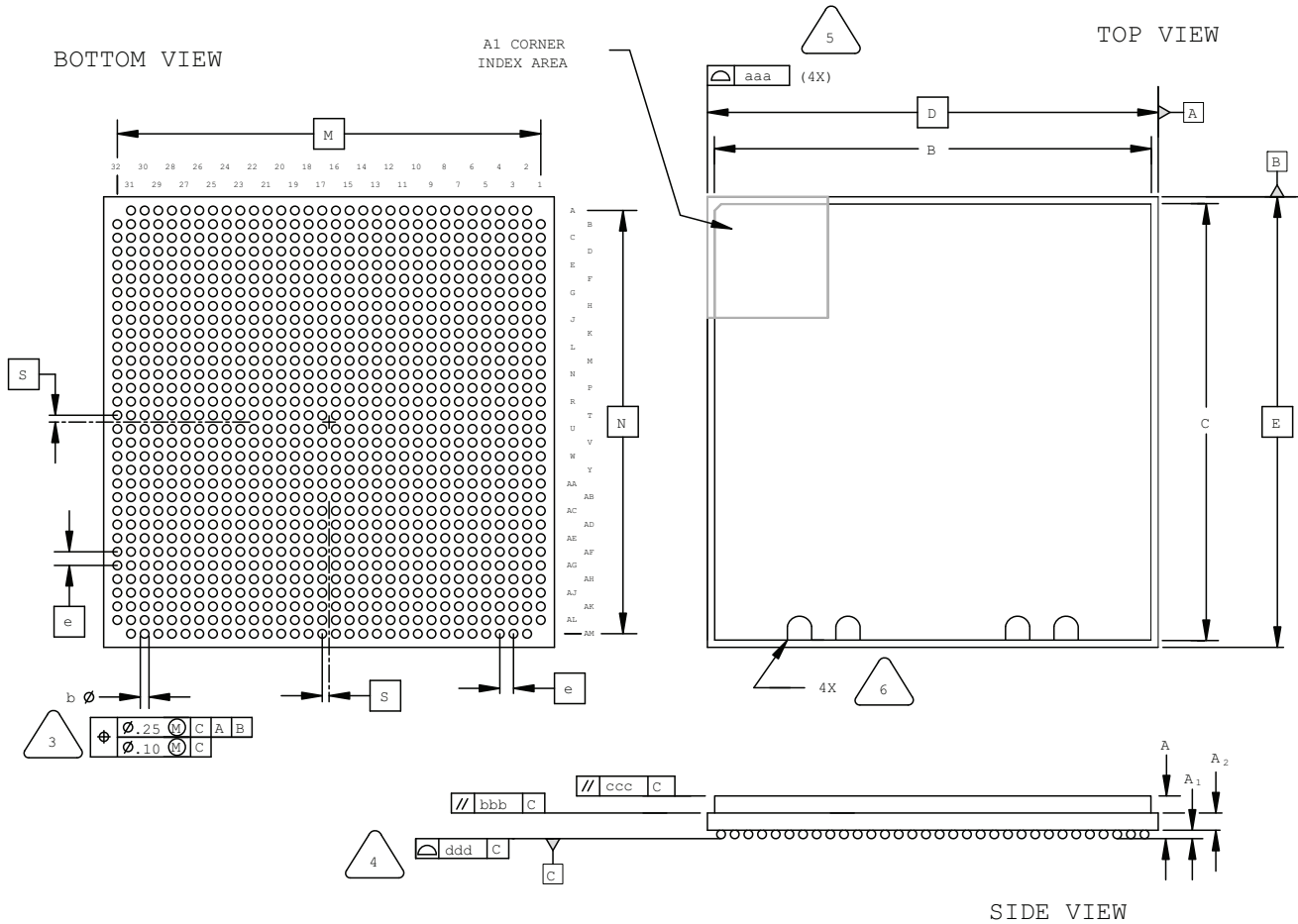

NOTES: UNLESS OTHERWISE SPECIFIED

- DIMENSIONS AND TOLERANCES PER ANSI Y14.5M.
- ALL DIMENSIONS ARE IN MILLIMETERS.



DIMENSION "b" IS MEASURED AT THE MAXIMUM SOLDER BALL DIAMETER, PARALLEL TO PRIMARY DATUM [C]



PRIMARY DATUM [C] AND SEATING PLANE ARE DEFINED BY THE SPHERICAL CROWNS OF THE SOLDER BALLS.



BILATERAL TOLERANCE ZONE IS APPLIED TO EACH SIDE OF THE PACKAGE BODY.



EXACT SHAPE AND SIZE OF THIS FEATURE IS OPTIONAL.

SYMBOL	MIN.	NOM.	MAX.
A	2.52	3.12	3.82
A1	0.30	0.50	0.70
A2	1.24 REF		
B/C	31.10	32.00	32.90
D/E	33.00 BSC		
M/N	31.00 BSC		
S	0.50 BSC		
b	0.50	0.60	0.70
e	1.00 BSC		
aaa	-	-	0.20
bbb	-	-	0.25
ccc	-	-	0.35
ddd	-	-	0.20

1020-Ball Organic fcBGA Package Rev. 2

Dimensions in Millimeters

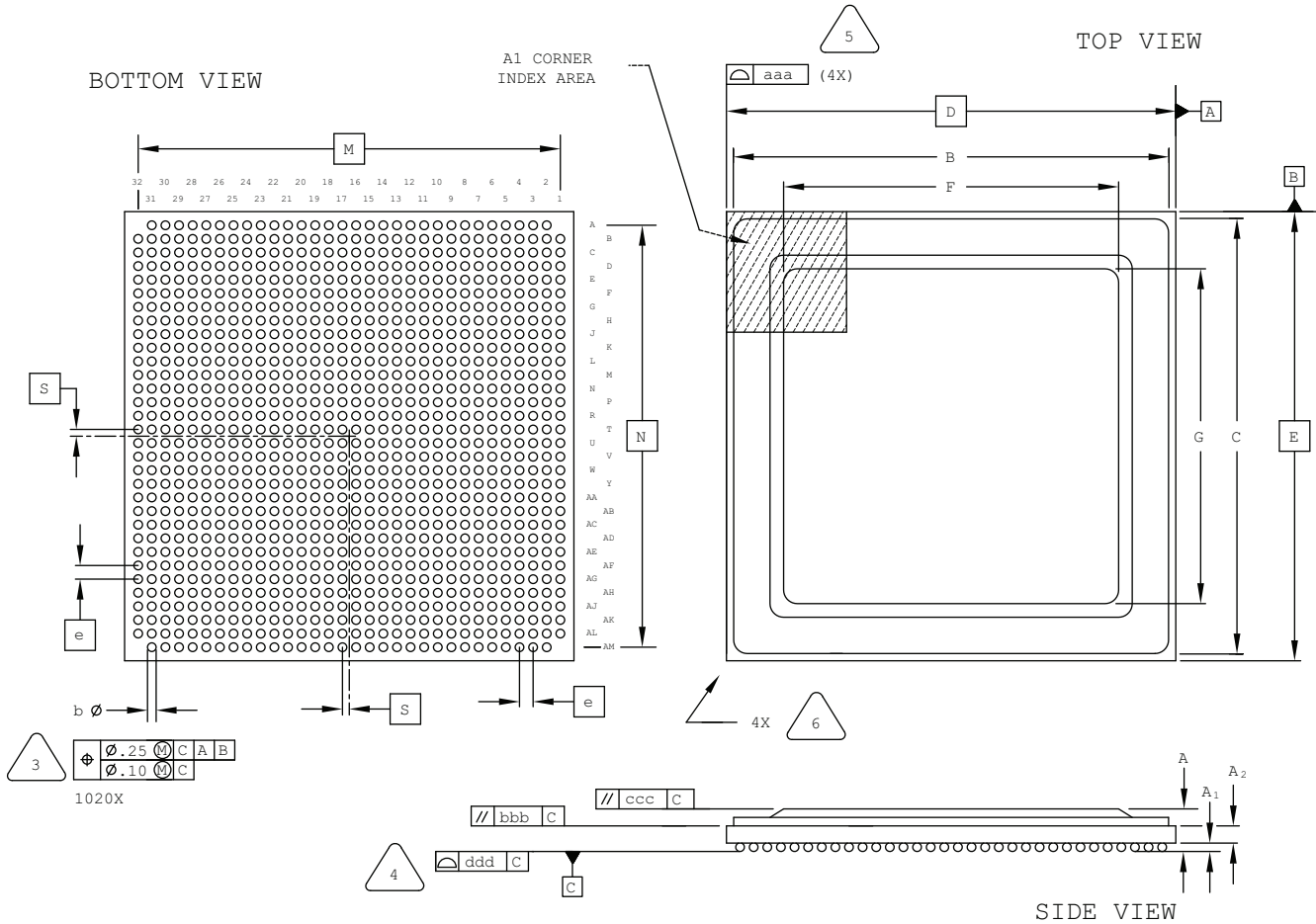

NOTES: UNLESS OTHERWISE SPECIFIED

- DIMENSIONS AND TOLERANCES PER ANSI Y14.5M.
- ALL DIMENSIONS ARE IN MILLIMETERS.



DIMENSION "b" IS MEASURED AT THE MAXIMUM SOLDER BALL DIAMETER, PARALLEL TO PRIMARY DATUM [C]



PRIMARY DATUM [C] AND SEATING PLANE ARE DEFINED BY THE SPHERICAL CROWNS OF THE SOLDER BALLS.



BILATERAL TOLERANCE ZONE IS APPLIED TO EACH SIDE OF THE PACKAGE BODY.



EXACT SHAPE AND SIZE OF THIS FEATURE IS OPTIONAL.

SYMBOL	MIN.	NOM.	MAX.
A	2.55	2.90	3.25
A1	0.40	0.50	0.60
A2	1.20 REF		
B/C	32.40	32.60	32.80
D/E	33.00 BSC		
F/G	24.50	24.60	24.70
M/N	31.00 BSC		
S	0.50 BSC		
b	0.50	0.60	0.70
e	1.00 BSC		
aaa	-	-	0.20
bbb	-	-	0.25
ccc	-	-	0.35
ddd	-	-	0.20

1036-Ball ftSBGA Package

Dimensions in Millimeters

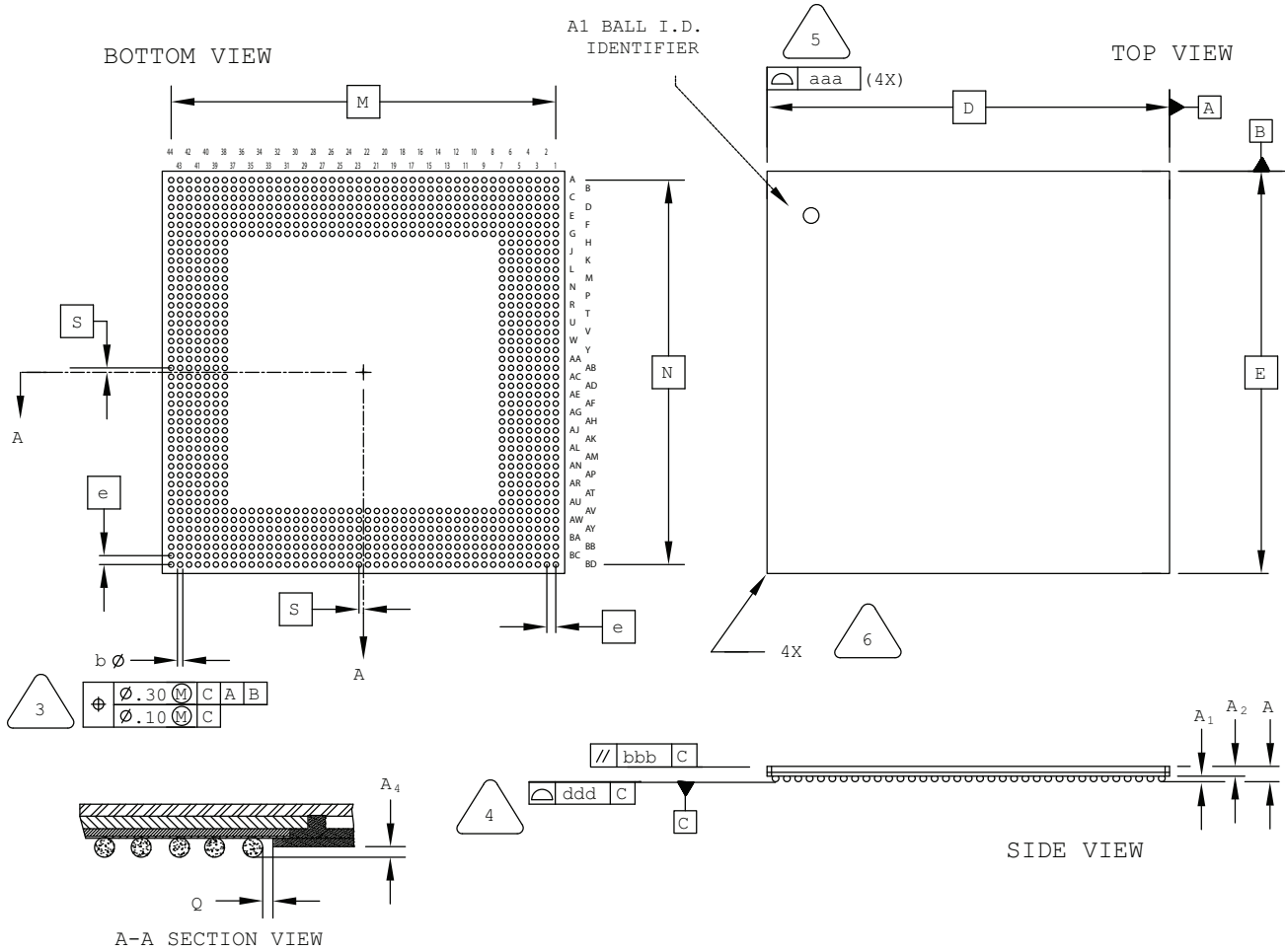

A-A SECTION VIEW

NOTES: UNLESS OTHERWISE SPECIFIED

1. DIMENSIONS AND TOLERANCES PER ANSI Y14.5M.
2. ALL DIMENSIONS ARE IN MILLIMETERS.

- 3. DIMENSION "b" IS MEASURED AT THE MAXIMUM SOLDER BALL DIAMETER, PARALLEL TO PRIMARY DATUM C
- 4. PRIMARY DATUM C AND SEATING PLANE ARE DEFINED BY THE SPHERICAL CROWNS OF THE SOLDER BALLS.
- 5. BILATERAL TOLERANCE ZONE IS APPLIED TO EACH SIDE OF THE PACKAGE BODY.
- 6. EXACT SHAPE AND SIZE OF THIS FEATURE IS OPTIONAL.

SYMBOL	MIN.	NOM.	MAX.
A	-	-	1.80
A1	0.40	0.55	0.70
A2	0.90	0.98	1.10
D/E	45.00 BSC		
M/N	43.00 BSC		
S	0.50 BSC		
b	0.50	0.65	0.80
e	1.00 BSC		
Q	0.25	-	-
A4	0.10	-	-
aaa	-	-	0.20
bbb	-	-	0.35
ddd	-	-	0.20

1152-Ball Organic fcBGA Package Option 1: LatticeSC/SCM40

Dimensions in Millimeters

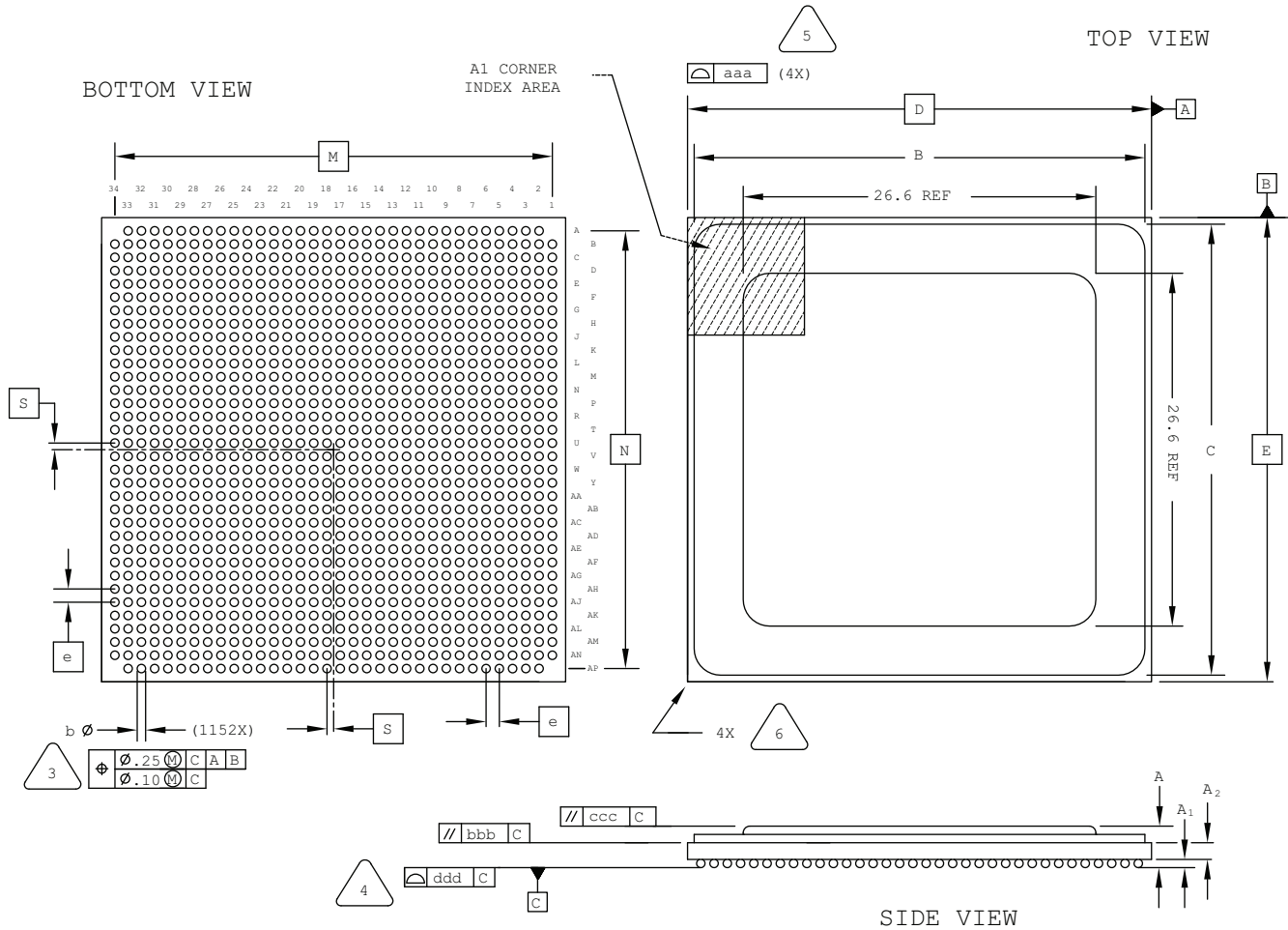

NOTES: UNLESS OTHERWISE SPECIFIED

1. DIMENSIONS AND TOLERANCES PER ANSI Y14.5M.
2. ALL DIMENSIONS ARE IN MILLIMETERS.



DIMENSION "b" IS MEASURED AT THE MAXIMUM SOLDER BALL DIAMETER, PARALLEL TO PRIMARY DATUM **C**



PRIMARY DATUM **C** AND SEATING PLANE ARE DEFINED BY THE SPHERICAL CROWNS OF THE SOLDER BALLS.



BILATERAL TOLERANCE ZONE IS APPLIED TO EACH SIDE OF THE PACKAGE BODY.



EXACT SHAPE AND SIZE OF THIS FEATURE IS OPTIONAL.

SYMBOL	MIN.	NOM.	MAX.
A	2.55	2.90	3.25
A1	0.35	0.50	0.65
A2	1.20 REF		
B/C	34.25	34.50	34.75
D/E	35.00 BSC		
M/N	33.00 BSC		
S	0.50 BSC		
b	0.50	0.60	0.70
e	1.00 BSC		
aaa	-	-	0.20
bbb	-	-	0.25
ccc	-	-	0.35
ddd	-	-	0.20

1152-Ball Organic fcBGA Package Option 2: LatticeSC/SCM80 & SC/SCM115

Dimensions in Millimeters

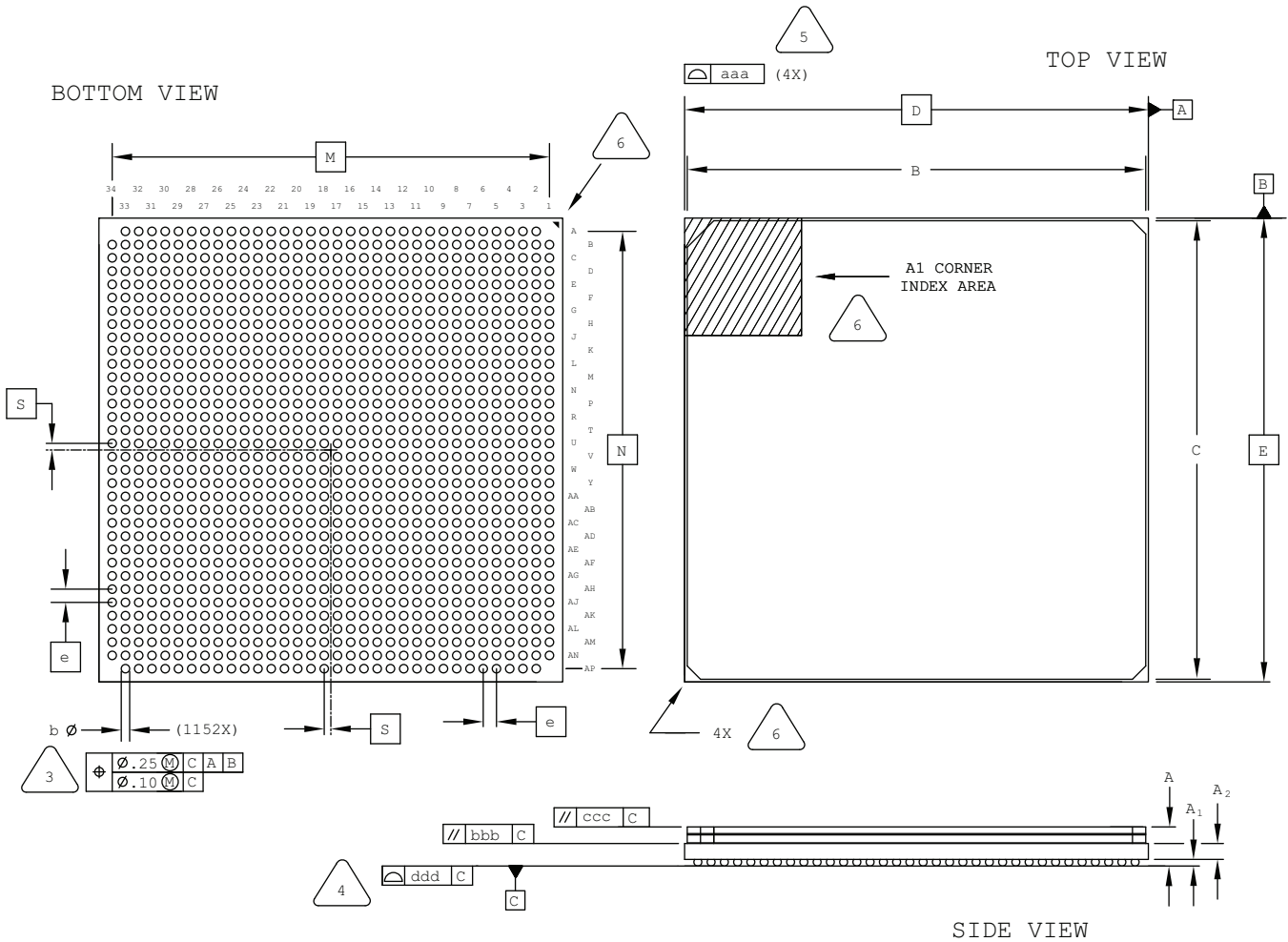

NOTES: UNLESS OTHERWISE SPECIFIED

1. DIMENSIONS AND TOLERANCES PER ANSI Y14.5M.
2. ALL DIMENSIONS ARE IN MILLIMETERS.

- 3 DIMENSION "b" IS MEASURED AT THE MAXIMUM SOLDER BALL DIAMETER, PARALLEL TO PRIMARY DATUM [C]
- 4 PRIMARY DATUM [C] AND SEATING PLANE ARE DEFINED BY THE SPHERICAL CROWNS OF THE SOLDER BALLS.
- 5 BILATERAL TOLERANCE ZONE IS APPLIED TO EACH SIDE OF THE PACKAGE BODY.
- 6 EXACT SHAPE AND SIZE OF THIS FEATURE IS OPTIONAL.

SYMBOL	MIN.	NOM.	MAX.
A	2.80	3.15	3.50
A1	0.35	0.50	0.65
A2	1.20 REF		
B/C	34.30	34.60	34.90
D/E	35.00 BSC		
M/N	33.00 BSC		
S	0.50 BSC		
b	0.50	0.60	0.70
e	1.00 BSC		
aaa	-	-	0.20
bbb	-	-	0.25
ccc	-	-	0.35
ddd	-	-	0.23

1152-Ball Ceramic fcBGA Package

Dimensions in Millimeters

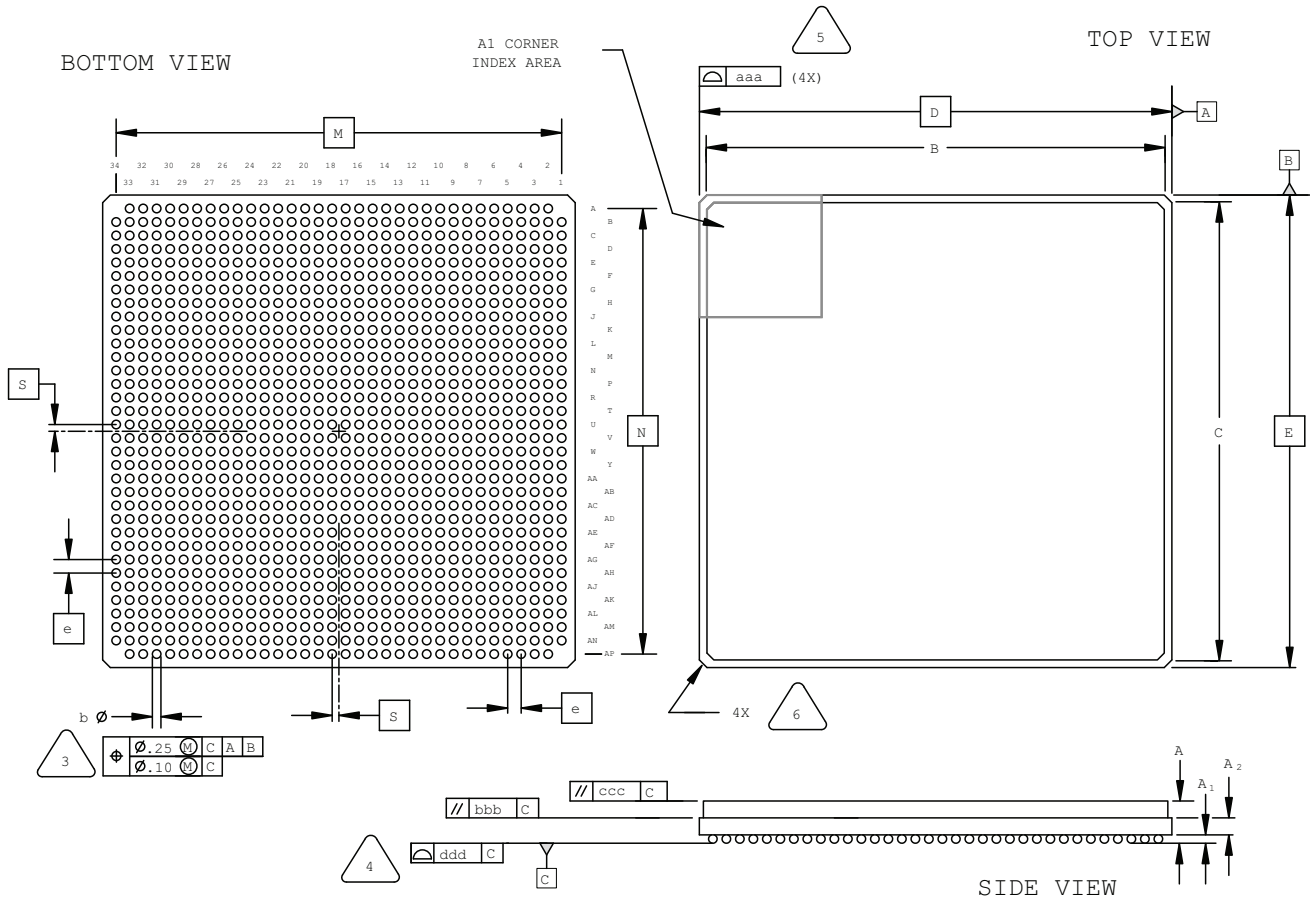

NOTES: UNLESS OTHERWISE SPECIFIED

1. DIMENSIONS AND TOLERANCES PER ANSI Y14.5M.
2. ALL DIMENSIONS ARE IN MILLIMETERS.

3 DIMENSION "b" IS MEASURED AT THE MAXIMUM SOLDER BALL DIAMETER, PARALLEL TO PRIMARY DATUM [C]

4 PRIMARY DATUM [C] AND SEATING PLANE ARE DEFINED BY THE SPHERICAL CROWNS OF THE SOLDER BALLS.

5 BILATERAL TOLERANCE ZONE IS APPLIED TO EACH SIDE OF THE PACKAGE BODY.

6 EXACT SHAPE AND SIZE OF THIS FEATURE IS OPTIONAL.

SYMBOL	MIN.	NOM.	MAX.
A	4.00	4.60	5.20
A1	0.30	0.50	0.70
A2	1.40 REF		
B/C	33.10	34.00	34.90
D/E	35.00 BSC		
M/N	33.00 BSC		
S	0.50 BSC		
b	0.50	0.60	0.70
e	1.00 BSC		
aaa	-	-	0.20
bbb	-	-	0.25
ccc	-	-	0.35
ddd	-	-	0.20

1152-Ball fpBGA Package

Dimensions in Millimeters

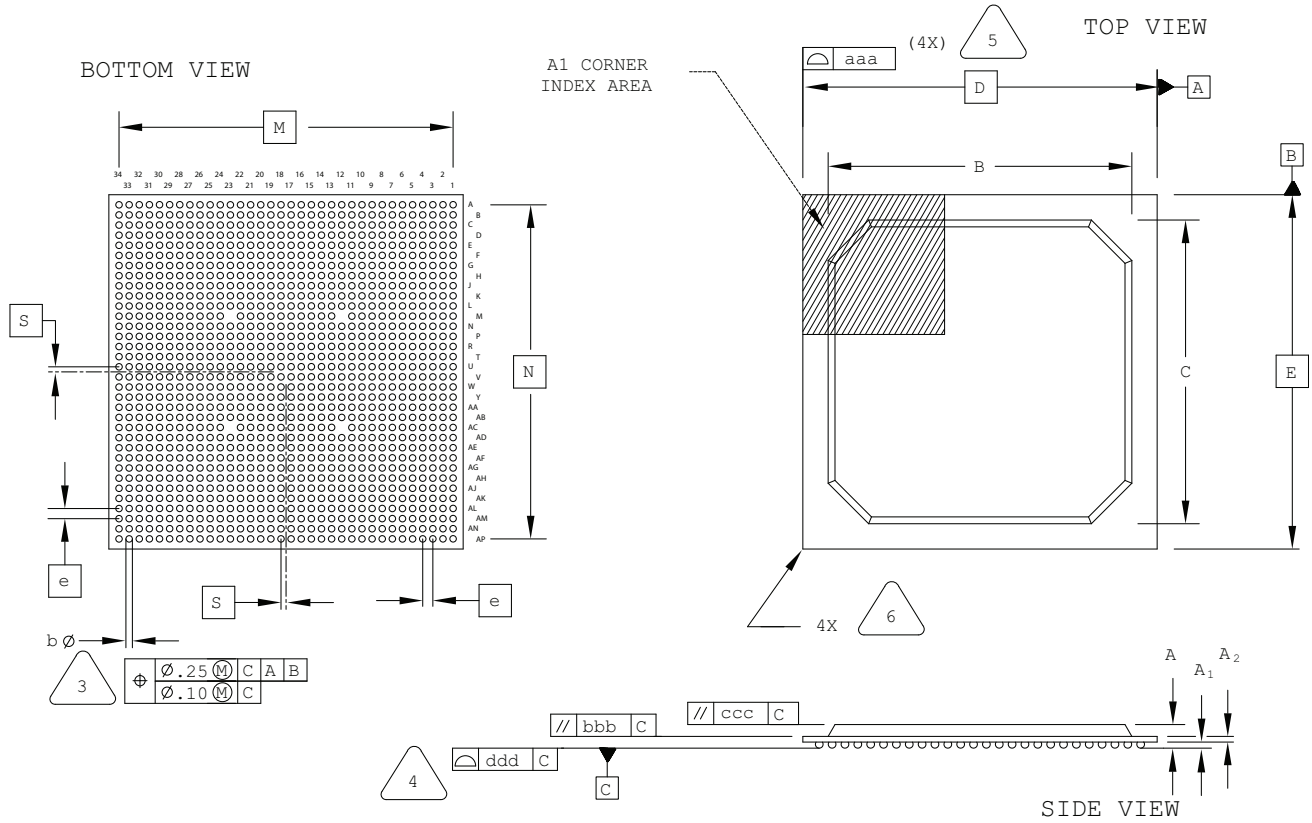

NOTES: UNLESS OTHERWISE SPECIFIED

1. DIMENSIONS AND TOLERANCES PER ANSI Y14.5M.
2. ALL DIMENSIONS ARE IN MILLIMETERS.



DIMENSION "b" IS MEASURED AT THE MAXIMUM SOLDER BALL DIAMETER, PARALLEL TO PRIMARY DATUM [C]



PRIMARY DATUM [C] AND SEATING PLANE ARE DEFINED BY THE SPHERICAL CROWNS OF THE SOLDER BALLS.



BILATERAL TOLERANCE ZONE IS APPLIED TO EACH SIDE OF THE PACKAGE BODY.



EXACT SHAPE AND SIZE OF THIS FEATURE IS OPTIONAL.

SYMBOL	MIN.	NOM.	MAX.
A	1.90	2.25	2.60
A1	0.30	0.50	0.70
A2	0.40	0.60	0.80
B/C	29.80	30.30	30.80
D/E	35.00 BSC		
M/N	33.00 BSC		
S	0.50 BSC		
b	0.50	0.60	0.70
e	1.00 BSC		
aaa	-	-	0.20
bbb	-	-	0.25
ccc	-	-	0.35
ddd	-	-	0.20

Note: Depopulated ball locations are M12, M23, AC12, and AC23.

1156-Ball fpBGA Package

Dimensions in Millimeters

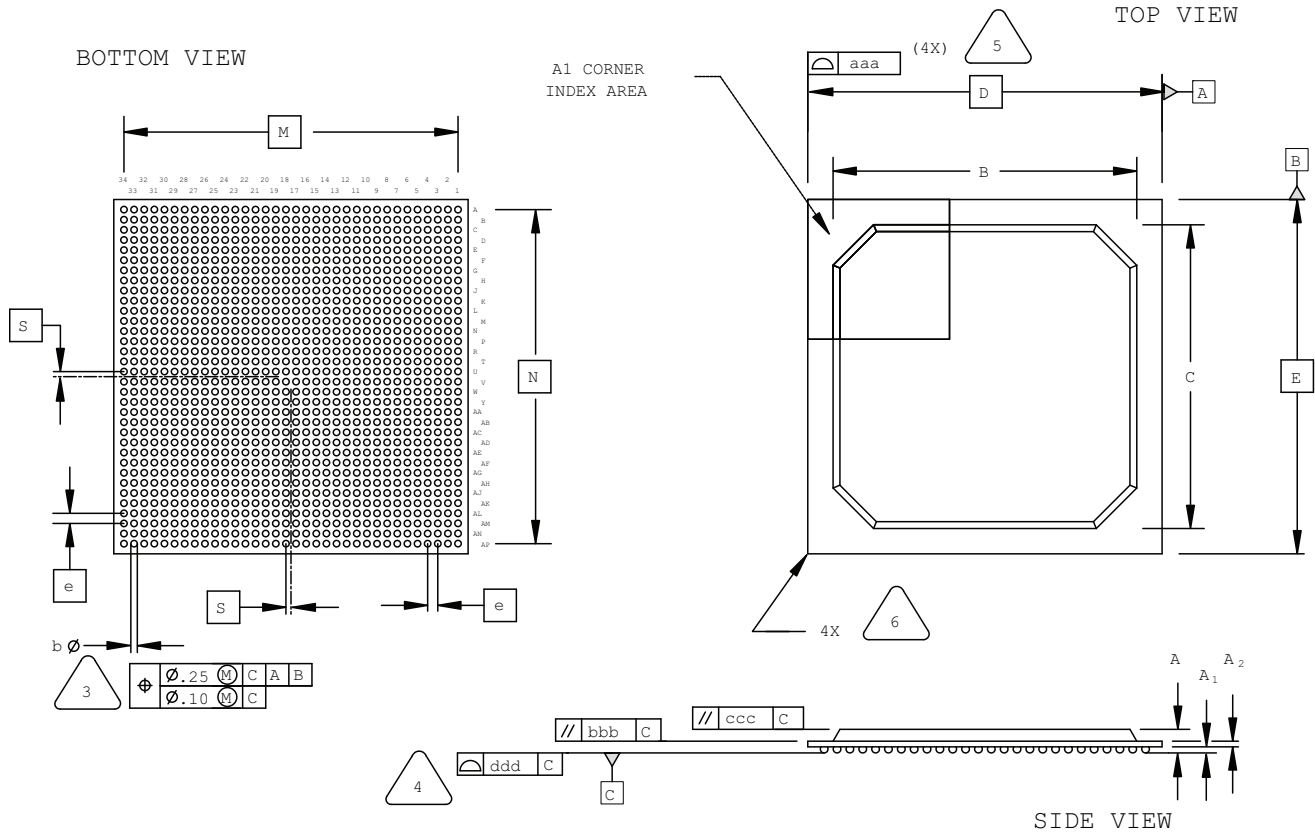

NOTES: UNLESS OTHERWISE SPECIFIED

- DIMENSIONS AND TOLERANCES PER ANSI Y14.5M.
- ALL DIMENSIONS ARE IN MILLIMETERS.



DIMENSION "b" IS MEASURED AT THE MAXIMUM SOLDER BALL DIAMETER, PARALLEL TO PRIMARY DATUM \square C



PRIMARY DATUM \square C AND SEATING PLANE ARE DEFINED BY THE SPHERICAL CROWNS OF THE SOLDER BALLS.



BILATERAL TOLERANCE ZONE IS APPLIED TO EACH SIDE OF THE PACKAGE BODY.



EXACT SHAPE AND SIZE OF THIS FEATURE IS OPTIONAL.

SYMBOL	MIN.	NOM.	MAX.
A	1.90	2.25	2.60
A1	0.30	0.50	0.70
A2	0.40	0.60	0.80
B/C	29.80	30.30	30.80
D/E	35.00 BSC		
M/N	33.00 BSC		
S	0.50 BSC		
b	0.50	0.60	0.70
e	1.00 BSC		
aaa	-	-	0.20
bbb	-	-	0.25
ccc	-	-	0.35
ddd	-	-	0.20

1704-Ball Organic fcBGA Package

Dimensions in Millimeters

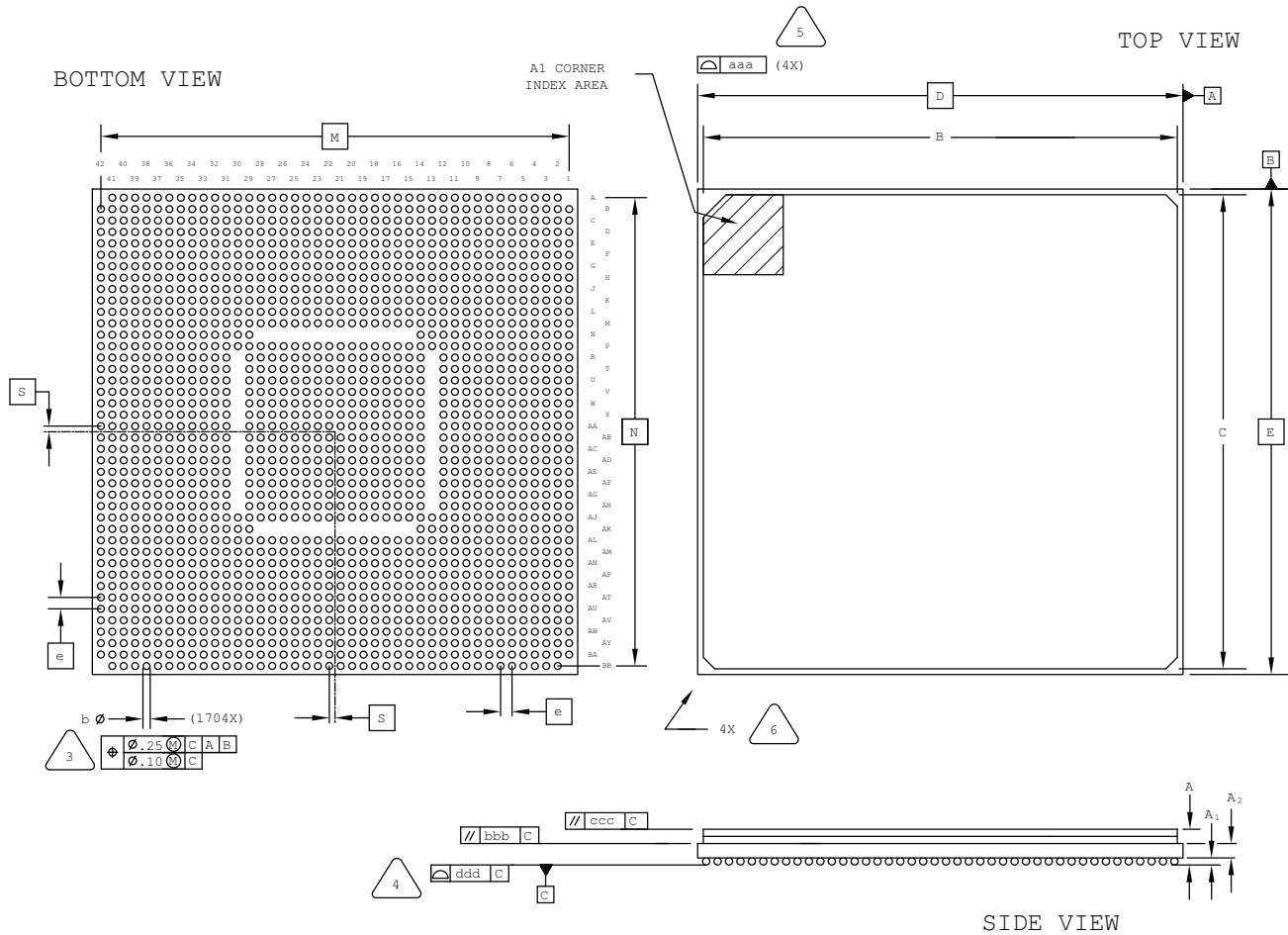

NOTES: UNLESS OTHERWISE SPECIFIED

- DIMENSIONS AND TOLERANCES PER ANSI Y14.5M.
- ALL DIMENSIONS ARE IN MILLIMETERS.



DIMENSION "b" IS MEASURED AT THE MAXIMUM SOLDER BALL DIAMETER, PARALLEL TO PRIMARY DATUM **C**



PRIMARY DATUM **C** AND SEATING PLANE ARE DEFINED BY THE SPHERICAL CROWNS OF THE SOLDER BALLS.



BILATERAL TOLERANCE ZONE IS APPLIED TO EACH SIDE OF THE PACKAGE BODY.



EXACT SHAPE AND SIZE OF THIS FEATURE IS OPTIONAL.

SYMBOL	MIN.	NOM.	MAX.
A	2.55	2.90	3.25
A1	0.35	0.50	0.65
A2	1.20 REF		
B/C	41.70	42.00	42.30
D/E	42.50 BSC		
M/N	42.50 BSC		
S	0.50 BSC		
b	0.50	0.60	0.70
e	1.00 BSC		
aaa	-	-	0.20
bbb	-	-	0.25
ccc	-	-	0.35
ddd	-	-	0.23

1704-Ball Ceramic fcBGA Package

Dimensions in Millimeters

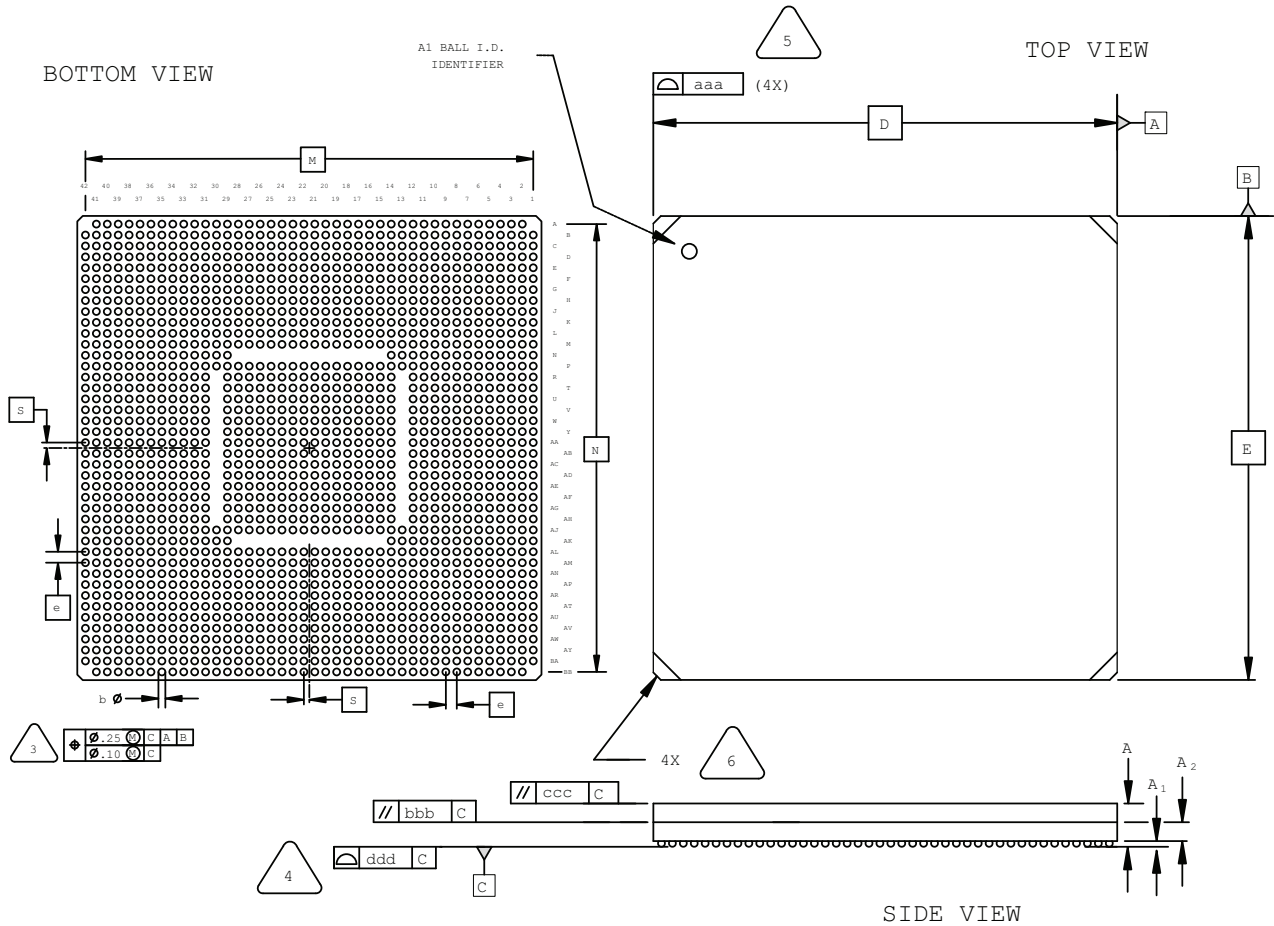

NOTES: UNLESS OTHERWISE SPECIFIED

- DIMENSIONS AND TOLERANCES PER ANSI Y14.5M.
- ALL DIMENSIONS ARE IN MILLIMETERS.



DIMENSION "b" IS MEASURED AT THE MAXIMUM SOLDER BALL DIAMETER, PARALLEL TO PRIMARY DATUM [C]



PRIMARY DATUM [C] AND SEATING PLANE ARE DEFINED BY THE SPHERICAL CROWNS OF THE SOLDER BALLS.



BILATERAL TOLERANCE ZONE IS APPLIED TO EACH SIDE OF THE PACKAGE BODY. PACKAGE BODY INCLUDES SUBSTRATE AND LID.

MAXIMUM OFFSET: 0.20 mm

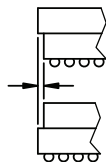

EXACT SHAPE AND SIZE OF THIS FEATURE IS OPTIONAL.

SYMBOL	MIN.	NOM.	MAX.
A	4.30	4.80	5.30
A1	0.30	0.50	0.70
A2	1.30	1.60	1.90
D/E	42.50 BSC		
M/N	41.00 BSC		
S	0.50 BSC		
b	0.50	0.60	0.70
e	1.00 BSC		
aaa	-	-	0.20
bbb	-	-	0.25
ccc	-	-	0.35
ddd	-	-	0.20

Revision History

Date	Version	Change Summary
February 2015	5.1	Added 36-Ball ucfBGA Package: iCE40 Ultra.
		Updated 36-Ball ucBGA Package heading to 36-Ball ucBGA Package Option 1.
		Updated 48-Pin QFN Package Option 2: L-ASC10 heading to 48-Pin QFN Package Option 2: L-ASC10, iCE40 Ultra.
January 2015	5.0	Added 16-Ball WLCS Package Option 2: iCE40 UltraLite.
		Updated 16-Ball WLCS Package heading to 16-Ball WLCS Package Option 1: iCE40 LP.
October 2014	4.9	Updated 48-Pin QFN Package heading and moved the section after 48-Pin QFN Package Option 1 (previously Option 2).
	4.8	Removed 20-Ball WLCS Package.
	4.7	Updated 121-Ball csfBGA Package. Revised M/N dimension.
September 2014	4.6	Updated 84-Pin QFN Package. Revised pin numbers from A36 and B27 to A37 and B28.
August 2014	4.5	Updated 16-Ball WLCS Package. Changed second E to e in REF. column.
		Updated 36-Ball WLCS Package Option 1: iCE40 Ultra heading.
		Added 36-Ball WLCS Package Option 2: MachXO3.
		Added 81-Ball WLCS Package.
		Added 121-Ball csfBGA Package.
		Added 256-Ball csfBGA Package.
		Added 324-Ball caBGA Package.
		Added 324-Ball csfBGA Package.
		Added 400-Ball caBGA Package.
		Updated 84-Pin QFN Package. Revised dimension "b" maximum value.
Updated 256-Ball ftBGA Package Option 1: ispMACH 4000, MachXO, LatticeXP2. Revised dimension "A" values.		
June 2014	4.4	Updated 48-Pin QFNS Package to 48-Pin QFN Package.
		Added 48-Pin QFN Package Option 2.
		Added 49-Ball WLCS Package.
		Added 237-Ball ftBGA Package.
		Added 285-Ball csfBGA Package.
		Added 20-Ball WLCS Package.
March 2014	04.3	Added 36-Ball WLCS Package.
		Restored references to indicate top, bottom, and side views.
		Added 381-Ball caBGA Package.
		Added 554-Ball caBGA Package.
December 2013	04.2	Added 756-Ball caBGA Package.
		Added "1" and "N" characters to 100-Pin TQFP Package Option 1: MachXO2, MachXO diagram (Top View).
		Added 16-ball WLCS package.
September 2013	04.1	Revised 25-Ball WLCS Package title to 25-Ball WLCS Package (0.40mm Pitch).
		Added 25-Ball WLCS Package (0.35mm Pitch).
		Added references to indicate top, bottom, and side views.
		Added 16-ball WLCS package.
August 2013	04.0	Revised 144-pin TQFP package diagram.
February 2013	03.9	Added 184-ball csBGA package.
November 2012	03.8	Added iCE40 to the list of applicable products for the 32-pin QFNS Option 1 package.
October 2012	03.7	Revised 324-ball ftBGA package drawing.

Date	Version	Change Summary
September 2012	03.6	Nomenclature change – “iCE40 100-Pin TQFP Package Option 2” changed to “iCE40 100-Pin VQFP Package Option 2”.
August 2012	03.5	Added 36-ball ucBGA, 49-ball ucBGA, 81-ball ucBGA, 81-ball csBGA, 84-pin QFN, 100-pin TQFP Option 2, 121-ball csBGA, 121-ball ucBGA, 132-ball csBGA Option 2, 196-ball csBGA, 225-ball ucBGA, 284-ball csBGA packages.
July 2012	03.4	Added 676-ball fcBGA package.
March 2012	03.3	Added new 32-Pin QFNS Package Option 2 for MachXO2. Moved 32-pin QFN (punch singulated) package drawing to new Package Archive Appendix.
February 2012	03.2	Updated document with new corporate logo.
December 2011	03.1	Updated WLCS package offering.
October 2011	03.0	Added 49-ball WLCS package and updated 25-ball WLCS package.
		Added 328-ball csBGA package.
July 2011	02.8	Included revised diagrams for the following packages: 56-ball csBGA, 100-ball csBGA and 132-ball csBGA. Added new 256-ball ftBGA Option 3 package.
May 2011	02.7	Added MachXO2 to the list of applicable products for the 256 ftBGA Option 1 package outline.
November 2010	02.6	Added 25-ball WLCS and 332-ball caBGA package drawings. Revised 100-pin PQFP, 120-pin PQFP, 128-pin PQFP, 160-pin PQFP and 208-pin PQFP package drawings. Removed obsolete packages including 144-, 240- and 304-pin PQFP packages.
October 2010	02.5	Added 208-ball ftBGA package.
September 2010	02.4	Revised maximum coplanarity values on Organic 1152 Flip Chip BGA – Option 2 and on Organic 1704 Flip Chip BGA from 0.20 mm to 0.23 mm.
March 2010	02.3	Added new 1020-ball Organic fcBGA rev.2, 1152-ball Organic fcBGA, and 1704-ball Organic fcBGA package drawings. Removed obsolete 492-Ball BGA package.
February 2010	02.2	Revised 256-ball caBGA nominal solder ball diameter from 0.5 mm to 0.45 mm to better match actual dimension.
December 2009	02.1	Revised 256-ball caBGA package to specify correct JEDEC reference number.
May 2009	02.0	Added new 256-ball caBGA and 256-ball ftBGA (Option A) packages.
April 2009	01.9	Added 24-pin QFNS package diagram. Removed discontinued and obsolete packages (16 SOIC, 20 SOIC, 24 SOIC, 28 SOIC, 16 PDIP, 240 MQFP, 269 fcBGA, 304 MQFP, 600 SBGA).
December 2008	01.8	Added 32-pin QFNS, 48-pin QFNS and 64-pin QFNS package diagrams.
November 2008	01.7	Added 64-ball ucBGA and 132-ball ucBGA package diagrams.
April 2008	01.6	Added 64-ball csBGA and 144-ball csBGA package diagrams.
November 2007	01.5	Added 1152-ball fpBGA package diagram.
October 2007	01.4	Revised 1036 ftSBGA package diagram. Removed 1036 fpSBGA.
June 2007	01.3	Added 1036 ftSBGA package diagram.
February 2007	01.2	Revised 1704 fcBGA package drawing: removed lid dimension, clarified package body dimension as the combination of substrate and lid.
January 2007	01.1	Added Marking Orientation text for all TQFP packages (1.0 mm and 1.4 mm thick).
October 2006	01.0	Added 64-pin TQFP and 1704-ball fcBGA package diagrams.
—	—	Previous Lattice releases.

Appendix A. Package Archive

32-Pin QFN (Punch Singulated) Package

Dimensions in Millimeters

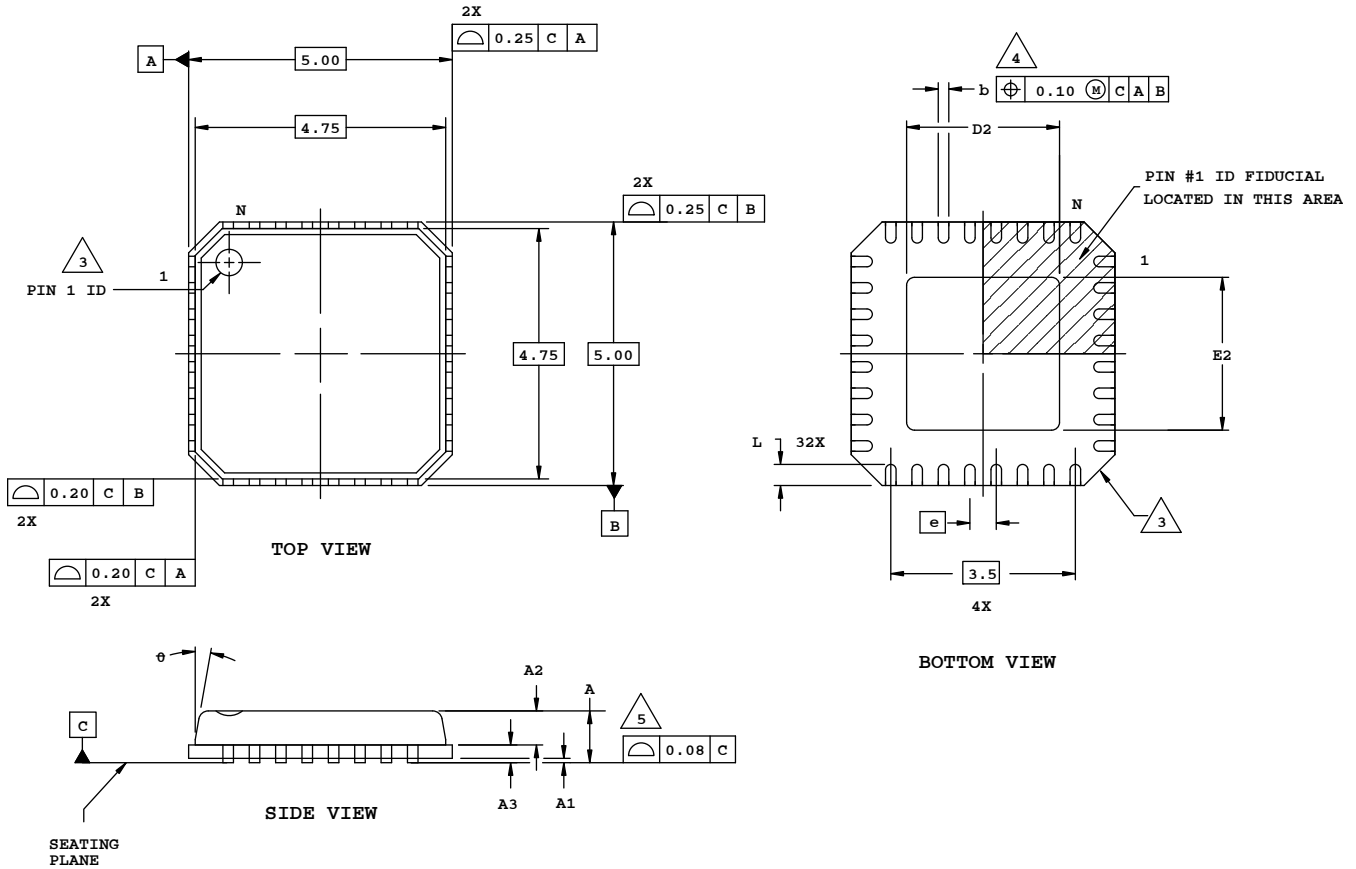

NOTES: UNLESS OTHERWISE SPECIFIED

- DIMENSIONS AND TOLERANCES PER ANSI Y14.5M.
- ALL DIMENSIONS ARE IN MILLIMETERS.

△ 3 EXACT SHAPE AND SIZE OF THIS FEATURE IS OPTIONAL.

△ 4 DIMENSION b APPLIES TO PLATED TERMINAL AND IS MEASURED BETWEEN 0.20 AND 0.25 mm FROM TERMINAL TIP.

△ 5 APPLIES TO EXPOSED PORTION OF TERMINALS.

SYMBOL	MIN.	NOM.	MAX.
A	-	0.85	1.00
A1	0.00	0.01	0.05
A2	0.00	0.65	1.00
A3	0.20 REF		
D2	1.25	2.70	3.25
E2	1.25	2.70	3.25
e	0.50 BSC		
b	0.18	0.24	0.30
L	0.30	0.40	0.50
ϕ	-	-	12

Компания «Life Electronics» занимается поставками электронных компонентов импортного и отечественного производства от производителей и со складов крупных дистрибьюторов Европы, Америки и Азии.

С конца 2013 года компания активно расширяет линейку поставок компонентов по направлению коаксиальный кабель, кварцевые генераторы и конденсаторы (керамические, пленочные, электролитические), за счёт заключения дистрибьюторских договоров

Мы предлагаем:

- Конкурентоспособные цены и скидки постоянным клиентам.
- Специальные условия для постоянных клиентов.
- Подбор аналогов.
- Поставку компонентов в любых объемах, удовлетворяющих вашим потребностям.
- Приемлемые сроки поставки, возможна ускоренная поставка.
- Доставку товара в любую точку России и стран СНГ.
- Комплексную поставку.
- Работу по проектам и поставку образцов.
- Формирование склада под заказчика.
- Сертификаты соответствия на поставляемую продукцию (по желанию клиента).
- Тестирование поставляемой продукции.
- Поставку компонентов, требующих военную и космическую приемку.
- Входной контроль качества.
- Наличие сертификата ISO.

В составе нашей компании организован Конструкторский отдел, призванный помогать разработчикам, и инженерам.

Конструкторский отдел помогает осуществить:

- Регистрацию проекта у производителя компонентов.
- Техническую поддержку проекта.
- Защиту от снятия компонента с производства.
- Оценку стоимости проекта по компонентам.
- Изготовление тестовой платы монтаж и пусконаладочные работы.



Тел: +7 (812) 336 43 04 (многоканальный)

Email: org@lifeelectronics.ru