

# MC74HC86A

## Quad 2-Input Exclusive OR Gate

### High-Performance Silicon-Gate CMOS

The MC74HC86A is identical in pinout to the LS86. The device inputs are compatible with standard CMOS outputs; with pullup resistors, they are compatible with LSTTL outputs.

#### Features

- Output Drive Capability: 10 LSTTL Loads
- Outputs Directly Interface to CMOS, NMOS, and TTL
- Operating Voltage Range: 2.0 to 6.0 V
- Low Input Current: 1  $\mu$ A
- High Noise Immunity Characteristic of CMOS Devices
- In Compliance with JEDEC Standard No. 7 A Requirements
- Chip Complexity: 56 FETs or 14 Equivalent Gates
- NLV Prefix for Automotive and Other Applications Requiring Unique Site and Control Change Requirements; AEC-Q100 Qualified and PPAP Capable
- These Devices are Pb-Free, Halogen Free and are RoHS Compliant

#### LOGIC DIAGRAM

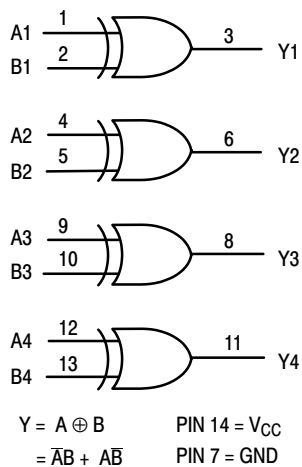

ON Semiconductor®

<http://onsemi.com>

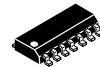

SOIC-14 NB  
D SUFFIX  
CASE 751A



TSSOP-14  
DT SUFFIX  
CASE 948G

#### PIN ASSIGNMENT

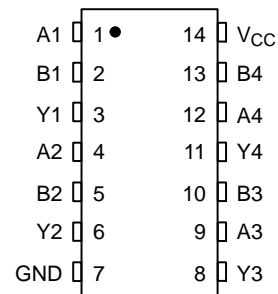

#### MARKING DIAGRAMS

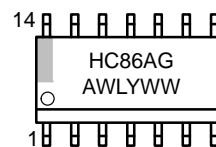

SOIC-14 NB

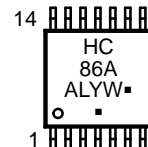

TSSOP-14

- A = Assembly Location
- L, WL = Wafer Lot
- Y, YY = Year
- W, WW = Work Week
- G or ■ = Pb-Free Package

(Note: Microdot may be in either location)

#### FUNCTION TABLE

| Inputs |   | Output |
|--------|---|--------|
| A      | B | Y      |
| L      | L | L      |
| L      | H | H      |
| H      | L | H      |
| H      | H | L      |

#### ORDERING INFORMATION

See detailed ordering and shipping information in the package dimensions section on page 4 of this data sheet.

# MC74HC86A

## MAXIMUM RATINGS

| Symbol    | Parameter   | Value                  | Unit |
|-----------|---|------------------------|------|
| $V_{CC}$  | DC Supply Voltage (Referenced to GND)   | -0.5 to +7.0           | V    |
| $V_{in}$  | DC Input Voltage (Referenced to GND)  | -0.5 to $V_{CC} + 0.5$ | V    |
| $V_{out}$ | DC Output Voltage (Referenced to GND)   | -0.5 to $V_{CC} + 0.5$ | V    |
| $I_{in}$  | DC Input Current, per Pin   | $\pm 20$               | mA   |
| $I_{out}$ | DC Output Current, per Pin  | $\pm 25$               | mA   |
| $I_{CC}$  | DC Supply Current, $V_{CC}$ and GND Pins  | $\pm 50$               | mA   |
| $P_D$     | Power Dissipation in Still Air, SOIC Package†<br>TSSOP Package†                         | 500<br>450             | mW   |
| $T_{stg}$ | Storage Temperature   | -65 to +150            | °C   |
| $T_L$     | Lead Temperature, 1 mm from Case for 10 Seconds<br>(Plastic DIP, SOIC or TSSOP Package) | 260                    | °C   |

This device contains protection circuitry to guard against damage due to high static voltages or electric fields. However, precautions must be taken to avoid applications of any voltage higher than maximum rated voltages to this high-impedance circuit. For proper operation,  $V_{in}$  and  $V_{out}$  should be constrained to the range  $GND \leq (V_{in} \text{ or } V_{out}) \leq V_{CC}$ . Unused inputs must always be tied to an appropriate logic voltage level (e.g., either GND or  $V_{CC}$ ). Unused outputs must be left open.

Stresses exceeding those listed in the Maximum Ratings table may damage the device. If any of these limits are exceeded, device functionality should not be assumed, damage may occur and reliability may be affected.

†Derating: SOIC Package: -7mW/°C from 65° to 125°C  
TSSOP Package: -6.1 mW/°C from 65° to 125°C

## RECOMMENDED OPERATING CONDITIONS

| Symbol            | Parameter  | Min   | Max                     | Unit |
|-------------------|--|---|-------------------------|------|
| $V_{CC}$          | DC Supply Voltage (Referenced to GND)                | 2.0   | 6.0                     | V    |
| $V_{in}, V_{out}$ | DC Input Voltage, Output Voltage (Referenced to GND) | 0   | $V_{CC}$                | V    |
| $T_A$             | Operating Temperature, All Package Types             | -55   | +125                    | °C   |
| $t_r, t_f$        | Input Rise and Fall Time<br>(Figure 1)               | $V_{CC} = 2.0\text{ V}$<br>$V_{CC} = 4.5\text{ V}$<br>$V_{CC} = 6.0\text{ V}$ | 0<br>1000<br>500<br>400 | ns   |

Functional operation above the stresses listed in the Recommended Operating Ranges is not implied. Extended exposure to stresses beyond the Recommended Operating Ranges limits may affect device reliability.

## DC ELECTRICAL CHARACTERISTICS (Voltages Referenced to GND)

| Symbol   | Parameter                                      | Test Conditions  | $V_{CC}$<br>V | Guaranteed Limit |           |           | Unit          |
|----------|--|--|---------------|------------------|-----------|-----------|---------------|
|          |  |  |               | -55 to<br>25°C   | ≤ 85°C    | ≤ 125°C   |               |
| $V_{IH}$ | Minimum High-Level Input Voltage               | $V_{out} = 0.1\text{ V or } V_{CC} - 0.1\text{ V}$<br>$ I_{out}  \leq 20\ \mu\text{A}$   | 2.0           | 1.5              | 1.5       | 1.5       | V             |
|          |  |  | 3.0           | 2.1              | 2.1       | 2.1       |               |
|          |  |  | 4.5           | 3.15             | 3.15      | 3.15      |               |
|          |  |  | 6.0           | 4.2              | 4.2       | 4.2       |               |
| $V_{IL}$ | Maximum Low-Level Input Voltage                | $V_{out} = 0.1\text{ V or } V_{CC} - 0.1\text{ V}$<br>$ I_{out}  \leq 20\ \mu\text{A}$   | 2.0           | 0.5              | 0.5       | 0.5       | V             |
|          |  |  | 3.0           | 0.9              | 0.9       | 0.9       |               |
|          |  |  | 4.5           | 1.35             | 1.35      | 1.35      |               |
|          |  |  | 6.0           | 1.8              | 1.8       | 1.8       |               |
| $V_{OH}$ | Minimum High-Level Output Voltage              | $V_{in} = V_{IH} \text{ or } V_{IL}$<br>$ I_{out}  \leq 20\ \mu\text{A}$   | 2.0           | 1.9              | 1.9       | 1.9       | V             |
|          |  |  | 4.5           | 4.4              | 4.4       | 4.4       |               |
|          |  |  | 6.0           | 5.9              | 5.9       | 5.9       |               |
|          |  | $V_{in} = V_{IH} \text{ or } V_{IL}$<br>$ I_{out}  \leq 2.4\text{ mA}$<br>$ I_{out}  \leq 4.0\text{ mA}$<br>$ I_{out}  \leq 5.2\text{ mA}$ | 3.0           | 2.48             | 2.34      | 2.20      |               |
|          |  |  | 4.5           | 3.98             | 3.84      | 3.70      |               |
|          |  |  | 6.0           | 5.48             | 5.34      | 5.20      |               |
| $V_{OL}$ | Maximum Low-Level Output Voltage               | $V_{in} = V_{IH} \text{ or } V_{IL}$<br>$ I_{out}  \leq 20\ \mu\text{A}$   | 2.0           | 0.1              | 0.1       | 0.1       | V             |
|          |  |  | 4.5           | 0.1              | 0.1       | 0.1       |               |
|          |  |  | 6.0           | 0.1              | 0.1       | 0.1       |               |
|          |  | $V_{in} = V_{IH} \text{ or } V_{IL}$<br>$ I_{out}  \leq 2.4\text{ mA}$<br>$ I_{out}  \leq 4.0\text{ mA}$<br>$ I_{out}  \leq 5.2\text{ mA}$ | 3.0           | 0.26             | 0.33      | 0.40      |               |
|          |  |  | 4.5           | 0.26             | 0.33      | 0.40      |               |
|          |  |  | 6.0           | 0.26             | 0.33      | 0.40      |               |
| $I_{in}$ | Maximum Input Leakage Current                  | $V_{in} = V_{CC} \text{ or } GND$  | 6.0           | $\pm 0.1$        | $\pm 1.0$ | $\pm 1.0$ | $\mu\text{A}$ |
| $I_{CC}$ | Maximum Quiescent Supply Current (per Package) | $V_{in} = V_{CC} \text{ or } GND$<br>$I_{out} = 0\ \mu\text{A}$  | 6.0           | 1.0              | 10        | 40        | $\mu\text{A}$ |

# MC74HC86A

## AC ELECTRICAL CHARACTERISTICS (C<sub>L</sub> = 50 pF, Input t<sub>r</sub> = t<sub>f</sub> = 6 ns)

| Symbol                                 | Parameter  | V <sub>CC</sub><br>V                    | Guaranteed Limit |        |         | Unit |
|--|--|---|------------------|--------|---------|------|
|  |  |   | -55 to<br>25°C   | ≤ 85°C | ≤ 125°C |      |
| t <sub>PLH</sub> ,<br>t <sub>PHL</sub> | Maximum Propagation Delay, Input A or B to Output Y<br>(Figures 1 and 2) | 2.0                                     | 100              | 125    | 150     | ns   |
|  |  | 3.0                                     | 80               | 90     | 110     |      |
|  |  | 4.5                                     | 20               | 25     | 31      |      |
|  |  | 6.0                                     | 17               | 21     | 26      |      |
| t <sub>TLH</sub> ,<br>t <sub>THL</sub> | Maximum Output Transition Time, Any Output<br>(Figures 1 and 2)          | 2.0                                     | 75               | 95     | 110     | ns   |
|  |  | 3.0                                     | 30               | 40     | 55      |      |
|  |  | 4.5                                     | 15               | 19     | 22      |      |
|  |  | 6.0                                     | 13               | 16     | 19      |      |
| C <sub>in</sub>                        | Maximum Input Capacitance  | —                                       | 10               | 10     | 10      | pF   |
| C <sub>PD</sub>                        | Power Dissipation Capacitance (Per Gate)*                                | Typical @ 25°C, V <sub>CC</sub> = 5.0 V |                  |        | pF      |      |
|  |  | 33                                      |                  |        |         |      |

\* Used to determine the no-load dynamic power consumption:  $P_D = C_{PD} V_{CC}^2 f + I_{CC} V_{CC}$ .

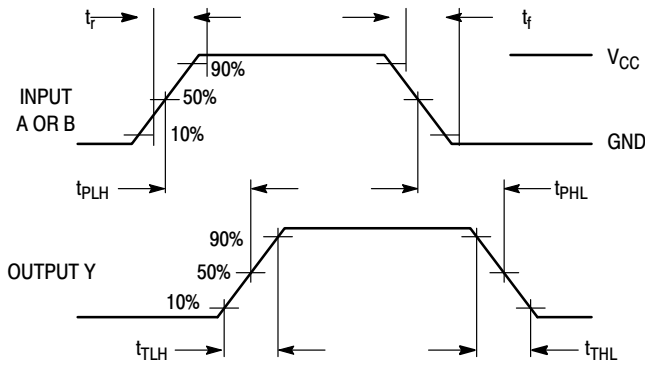
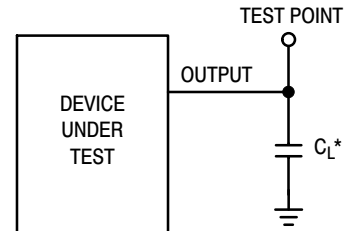

Figure 1. Switching Waveforms



\*Includes all probe and jig capacitance

Figure 2. Test Circuit

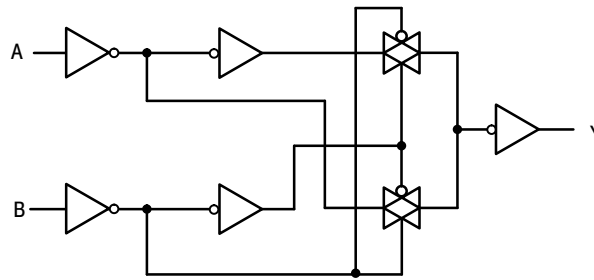

Figure 3. Expanded Logic Diagram  
(1/4 of Device)

# MC74HC86A

## ORDERING INFORMATION

| Device           | Package                 | Shipping†          |
|------------------|-------------------------|--------------------|
| MC74HC86ADG      | SOIC-14 NB<br>(Pb-Free) | 55 Units / Rail    |
| NLV74HC86ADG*    | SOIC-14 NB<br>(Pb-Free) | 55 Units / Rail    |
| MC74HC86ADR2G    | SOIC-14 NB<br>(Pb-Free) | 2500 / Tape & Reel |
| NLV74HC86ADR2G*  | SOIC-14 NB<br>(Pb-Free) | 2500 / Tape & Reel |
| MC74HC86ADTR2G   | TSSOP-14<br>(Pb-Free)   | 2500 / Tape & Reel |
| NLV74HC86ADTR2G* | TSSOP-14<br>(Pb-Free)   | 2500 / Tape & Reel |

†For information on tape and reel specifications, including part orientation and tape sizes, please refer to our Tape and Reel Packaging Specifications Brochure, BRD8011/D.

\*NLV Prefix for Automotive and Other Applications Requiring Unique Site and Control Change Requirements; AEC-Q100 Qualified and PPAP Capable.

# MC74HC86A

## PACKAGE DIMENSIONS

TSSOP-14  
CASE 948G  
ISSUE B

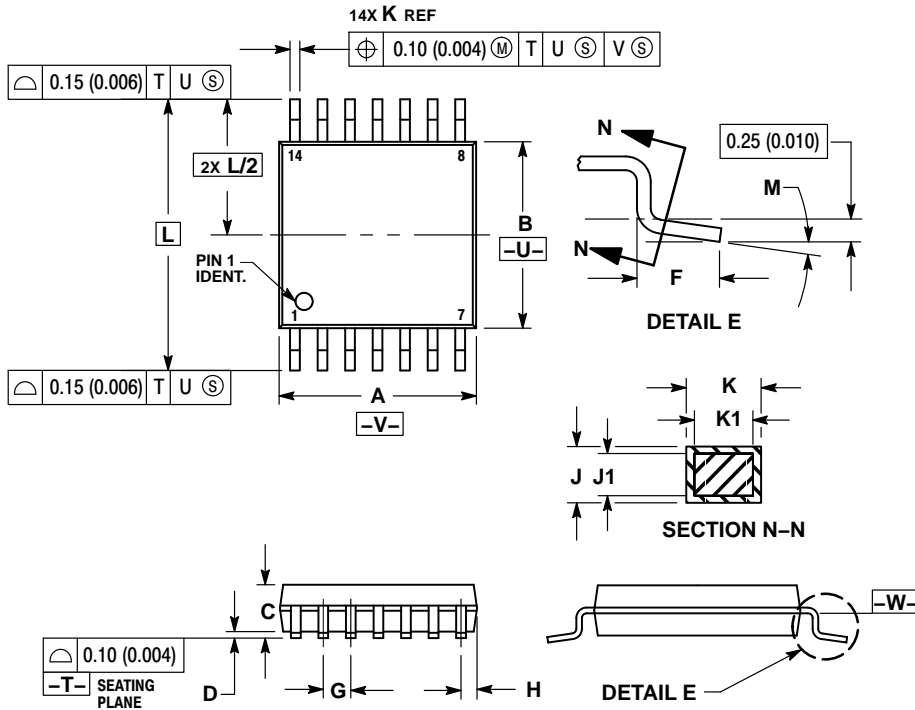

### NOTES:

1. DIMENSIONING AND TOLERANCING PER ANSI Y14.5M, 1982.
2. CONTROLLING DIMENSION: MILLIMETER.
3. DIMENSION A DOES NOT INCLUDE MOLD FLASH, PROTRUSIONS OR GATE BURRS. MOLD FLASH OR GATE BURRS SHALL NOT EXCEED 0.15 (0.006) PER SIDE.
4. DIMENSION B DOES NOT INCLUDE INTERLEAD FLASH OR PROTRUSION. INTERLEAD FLASH OR PROTRUSION SHALL NOT EXCEED 0.25 (0.010) PER SIDE.
5. DIMENSION K DOES NOT INCLUDE DAMBAR PROTRUSION. ALLOWABLE DAMBAR PROTRUSION SHALL BE 0.08 (0.003) TOTAL IN EXCESS OF THE K DIMENSION AT MAXIMUM MATERIAL CONDITION.
6. TERMINAL NUMBERS ARE SHOWN FOR REFERENCE ONLY.
7. DIMENSION A AND B ARE TO BE DETERMINED AT DATUM PLANE -W-.

| DIM | MILLIMETERS |      | INCHES    |       |
|-----|-------------|------|-----------|-------|
|     | MIN         | MAX  | MIN       | MAX   |
| A   | 4.90        | 5.10 | 0.193     | 0.200 |
| B   | 4.30        | 4.50 | 0.169     | 0.177 |
| C   | ---         | 1.20 | ---       | 0.047 |
| D   | 0.05        | 0.15 | 0.002     | 0.006 |
| F   | 0.50        | 0.75 | 0.020     | 0.030 |
| G   | 0.65 BSC    |      | 0.026 BSC |       |
| H   | 0.50        | 0.60 | 0.020     | 0.024 |
| J   | 0.09        | 0.20 | 0.004     | 0.008 |
| J1  | 0.09        | 0.16 | 0.004     | 0.006 |
| K   | 0.19        | 0.30 | 0.007     | 0.012 |
| K1  | 0.19        | 0.25 | 0.007     | 0.010 |
| L   | 6.40 BSC    |      | 0.252 BSC |       |
| M   | 0°          | 8°   | 0°        | 8°    |

### SOLDERING FOOTPRINT

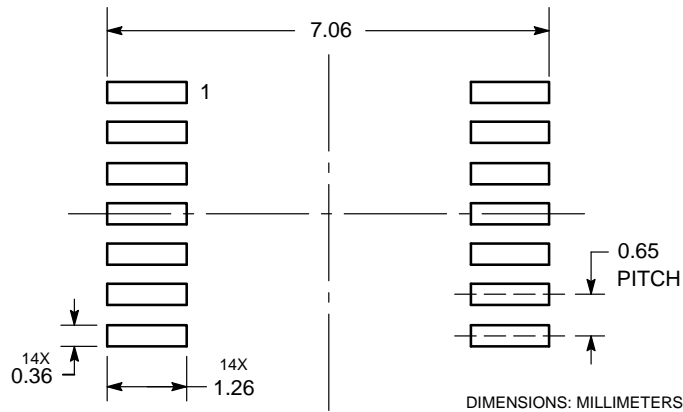

DIMENSIONS: MILLIMETERS

# MC74HC86A

## PACKAGE DIMENSIONS

SOIC-14 NB  
CASE 751A-03  
ISSUE K

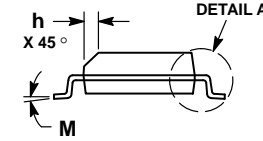
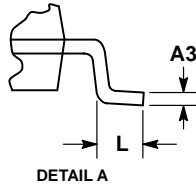
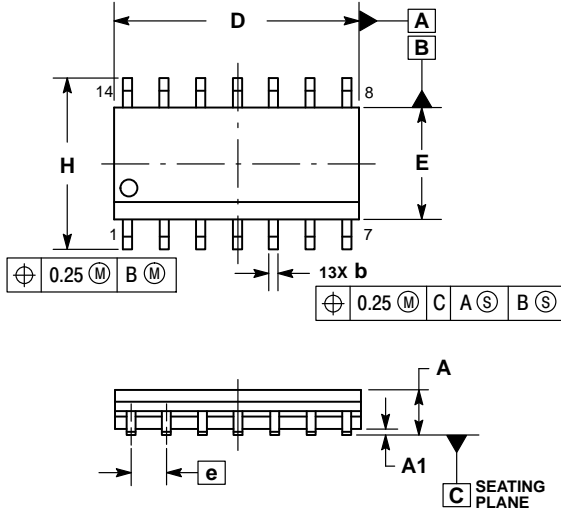

NOTES:

1. DIMENSIONING AND TOLERANCING PER ASME Y14.5M, 1994.
2. CONTROLLING DIMENSION: MILLIMETERS.
3. DIMENSION b DOES NOT INCLUDE DAMBAR PROTRUSION. ALLOWABLE PROTRUSION SHALL BE 0.13 TOTAL IN EXCESS OF AT MAXIMUM MATERIAL CONDITION.
4. DIMENSIONS D AND E DO NOT INCLUDE MOLD PROTRUSIONS.
5. MAXIMUM MOLD PROTRUSION 0.15 PER SIDE.

| DIM | MILLIMETERS |      | INCHES    |       |
|-----|-------------|------|-----------|-------|
|     | MIN         | MAX  | MIN       | MAX   |
| A   | 1.35        | 1.75 | 0.054     | 0.068 |
| A1  | 0.10        | 0.25 | 0.004     | 0.010 |
| A3  | 0.19        | 0.25 | 0.008     | 0.010 |
| b   | 0.35        | 0.49 | 0.014     | 0.019 |
| D   | 8.55        | 8.75 | 0.337     | 0.344 |
| E   | 3.80        | 4.00 | 0.150     | 0.157 |
| e   | 1.27 BSC    |      | 0.050 BSC |       |
| H   | 5.80        | 6.20 | 0.228     | 0.244 |
| h   | 0.25        | 0.50 | 0.010     | 0.019 |
| L   | 0.40        | 1.25 | 0.016     | 0.049 |
| M   | 0°          | 7°   | 0°        | 7°    |

### SOLDERING FOOTPRINT\*

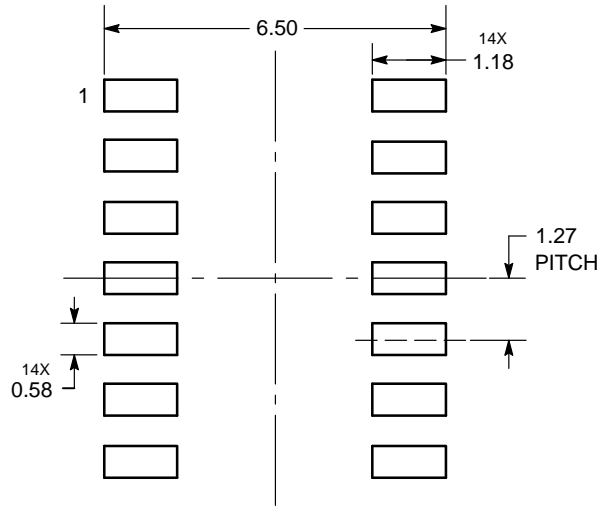

DIMENSIONS: MILLIMETERS

\*For additional information on our Pb-Free strategy and soldering details, please download the ON Semiconductor Soldering and Mounting Techniques Reference Manual, SOLDERRM/D.

ON Semiconductor and the ON logo are registered trademarks of Semiconductor Components Industries, LLC (SCILLC) or its subsidiaries in the United States and/or other countries. SCILLC owns the rights to a number of patents, trademarks, copyrights, trade secrets, and other intellectual property. A listing of SCILLC's product/patent coverage may be accessed at [www.onsemi.com/site/pdf/Patent-Marking.pdf](http://www.onsemi.com/site/pdf/Patent-Marking.pdf). SCILLC reserves the right to make changes without further notice to any products herein. SCILLC makes no warranty, representation or guarantee regarding the suitability of its products for any particular purpose, nor does SCILLC assume any liability arising out of the application or use of any product or circuit, and specifically disclaims any and all liability, including without limitation special, consequential or incidental damages. "Typical" parameters which may be provided in SCILLC data sheets and/or specifications can and do vary in different applications and actual performance may vary over time. All operating parameters, including "Typicals" must be validated for each customer application by customer's technical experts. SCILLC does not convey any license under its patent rights nor the rights of others. SCILLC products are not designed, intended, or authorized for use as components in systems intended for surgical implant into the body, or other applications intended to support or sustain life, or for any other application in which the failure of the SCILLC product could create a situation where personal injury or death may occur. Should Buyer purchase or use SCILLC products for any such unintended or unauthorized application, Buyer shall indemnify and hold SCILLC and its officers, employees, subsidiaries, affiliates, and distributors harmless against all claims, costs, damages, and expenses, and reasonable attorney fees arising out of, directly or indirectly, any claim of personal injury or death associated with such unintended or unauthorized use, even if such claim alleges that SCILLC was negligent regarding the design or manufacture of the part. SCILLC is an Equal Opportunity/Affirmative Action Employer. This literature is subject to all applicable copyright laws and is not for resale in any manner.

### PUBLICATION ORDERING INFORMATION

**LITERATURE FULFILLMENT:**  
Literature Distribution Center for ON Semiconductor  
P.O. Box 5163, Denver, Colorado 80217 USA  
Phone: 303-675-2175 or 800-344-3860 Toll Free USA/Canada  
Fax: 303-675-2176 or 800-344-3867 Toll Free USA/Canada  
Email: [orderlit@onsemi.com](mailto:orderlit@onsemi.com)

**N. American Technical Support:** 800-282-9855 Toll Free  
USA/Canada  
**Europe, Middle East and Africa Technical Support:**  
Phone: 421 33 790 2910  
**Japan Customer Focus Center**  
Phone: 81-3-5817-1050

**ON Semiconductor Website:** [www.onsemi.com](http://www.onsemi.com)  
**Order Literature:** <http://www.onsemi.com/orderlit>  
For additional information, please contact your local Sales Representative

Компания «Life Electronics» занимается поставками электронных компонентов импортного и отечественного производства от производителей и со складов крупных дистрибьюторов Европы, Америки и Азии.

С конца 2013 года компания активно расширяет линейку поставок компонентов по направлению коаксиальный кабель, кварцевые генераторы и конденсаторы (керамические, пленочные, электролитические), за счёт заключения дистрибьюторских договоров

Мы предлагаем:

- Конкурентоспособные цены и скидки постоянным клиентам.
- Специальные условия для постоянных клиентов.
- Подбор аналогов.
- Поставку компонентов в любых объемах, удовлетворяющих вашим потребностям.
- Приемлемые сроки поставки, возможна ускоренная поставка.
- Доставку товара в любую точку России и стран СНГ.
- Комплексную поставку.
- Работу по проектам и поставку образцов.
- Формирование склада под заказчика.
- Сертификаты соответствия на поставляемую продукцию (по желанию клиента).
- Тестирование поставляемой продукции.
- Поставку компонентов, требующих военную и космическую приемку.
- Входной контроль качества.
- Наличие сертификата ISO.

В составе нашей компании организован Конструкторский отдел, призванный помогать разработчикам, и инженерам.

Конструкторский отдел помогает осуществить:

- Регистрацию проекта у производителя компонентов.
- Техническую поддержку проекта.
- Защиту от снятия компонента с производства.
- Оценку стоимости проекта по компонентам.
- Изготовление тестовой платы монтаж и пусконаладочные работы.



Тел: +7 (812) 336 43 04 (многоканальный)

Email: [org@lifeelectronics.ru](mailto:org@lifeelectronics.ru)