

T1/E1/CEPT/ISDN-PRI TRANSFORMERS

Quad Port T1/E1 with 8 Transformers, 1500 Vrms

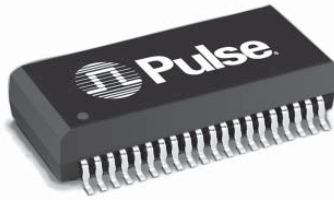

- RoHS peak reflow temperature rating 245°C
- Models matched to leading quad and dual T1/E1/CEPT/ISDN-PRI transceivers
- Crosstalk: -65 dB or better
- UL1950 recognized (some parts pending approval)
- RoHS compliant versions available upon request

Electrical Specifications @ 25°C

| RoHS Compliant Part Number ^C | | Turns Ratio ^{A, B} (Pri:Sec ±2%) | | OCL @ 25°C (mH MIN) ^F | | LL (µH MAX) | | C _{ww} (pF MAX) | | Package/ Schematic ^E | Primary Pins | |
|---|----------------------|--|----------|-------------------------------------|-----|----------------|-----|-----------------------------|----|------------------------------------|----------------------------|----------------------------|
| Std Temp. | Ex Temp ^F | TX | RX | TX | RX | TX | RX | TX | RX | | Transmit | Receive |
| T1063NL | — | 1:1.36 | 1:1.36CT | 1.2 | 1.2 | .6 | .6 | 35 | 35 | TOU/1 | 1-2, 6-7, 11-12, 16-17 | 38-36, 33-31, 28-26, 23-21 |
| T1064NL | — | 1:1.14 | 1:1.14CT | 1.2 | 1.2 | .6 | .6 | 35 | 35 | TOU/1 | 1-2, 6-7, 11-12, 16-17 | 38-36, 33-31, 28-26, 23-21 |
| T1065NL | T1105NL | 1:2CT | 1:2CT | 1.2 | 1.2 | .8 | .8 | 35 | 35 | TOU/3 | 4-5, 9-10, 14-15, 19-20 | 24-25, 29-30, 34-35, 39-40 |
| T1068NL | T1108NL | 1:2CT | 1:1CT | 1.2 | 1.2 | .6 | .6 | 35 | 35 | TOU/2 | 1-2, 6-7, 11-12, 16-17 | 21-22, 26-27, 31-32, 36-37 |
| T1071NL ^D | — | 1:1/1.26 | 1:2CT | 1.2 | 1.2 | .6 | .6 | 35 | 35 | TOU/2 | 1-2, 6-7, 11-12, 16-17 | 21-22, 26-27, 31-32, 36-37 |
| T1073NL | — | 1:2 | 1:2 | 1.2 | 1.2 | .6 | .6 | 35 | 35 | TOU/4 | 1-3, 6-8, 11-13, 16-18 | 4-5, 9-10, 14-15, 19-20 |
| T1124NL | T1114NL | 1:2CT | 1CT:2 | 1.2 | 1.2 | .6 | .6 | 35 | 35 | TOU/3 | 4-5, 9-10, 14-15, 19-20 | 1-3, 6-8, 11-13, 16-18 |
| T1129NL | — | 1:1.36CT | 1:1CT | 1.2 | 1.2 | .6 | .6 | 35 | 35 | TOU/3 | 24-25, 29-30, 34-35, 39-40 | 4-5, 9-10, 14-15, 19-20 |
| T1142NL | T1231NL | 1:2.4 | 1:1 | 1.0 | 1.0 | .5 | .5 | 35 | 35 | TOU/5 | 1-2, 8-9, 11-12, 18-19 | 24-25, 27-28, 34-35, 37-38 |
| T1145NL ^D | — | 1:2/2.4 | 1:0.79/1 | 1.0 | 1.0 | 1.0 | 1.0 | 35 | 35 | TOU/6 | 1-2, 9-10, 11-12, 19-20 | 37-36, 35-34, 27-26, 25-24 |
| — | TX1262NL | 1:2 | 1:2 | 1.2 | 1.2 | .7 | .7 | 35 | 35 | TOU/5 | 1-2, 6-7, 11-12, 16-17 | 3-4, 8-9, 13-14, 18-19 |
| — | TX1264NL | 1:2CT | 1CT:1 | 1.2 | 1.2 | .6 | .6 | 35 | 35 | TOU/3 | 4-5, 9-10, 14-15, 19-20 | 1-3, 6-8, 11-13, 16-18 |
| — | TX1266NL | 1:2 | 1:1 | 1.2 | 1.2 | .6 | .6 | 35 | 35 | TOU/4 | 1-3, 6-8, 11-13, 16-18 | 4-5, 9-10, 14-15, 19-20 |
| — | TX1295NL | 1:1.26CT | 1:1.26CT | 1.2 | 1.2 | .6 | .6 | 35 | 35 | TOU/3 | 4-5, 9-10, 14-15, 19-20 | 24-25, 29-30, 34-35, 39-40 |

NOTE: Chart Notes and TOU Schematics are on page 2.

Mechanical

TOU

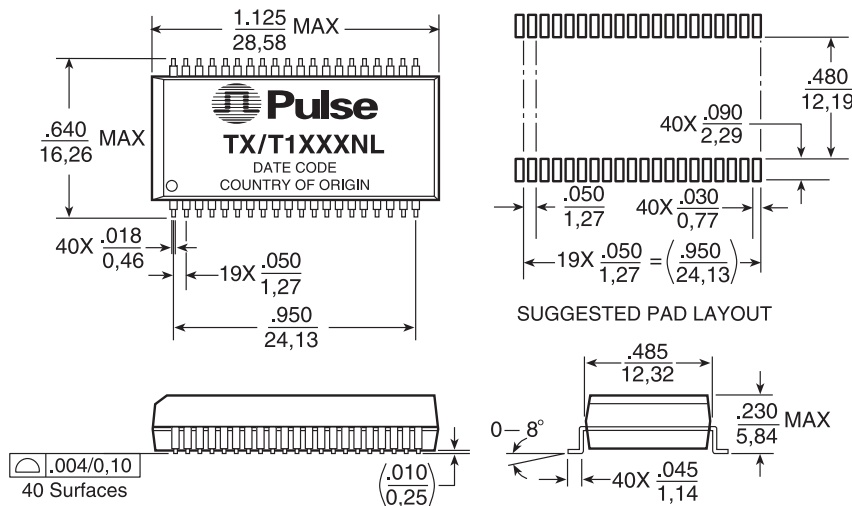

Weight 4.0 grams
 Tape & Reel 250/reel
 Tube 15/tube

Dimensions: $\frac{\text{Inches}}{\text{mm}}$ Unless otherwise specified, all tolerances are $\pm \frac{.010}{0.25}$

T1/E1/CEPT/ISDN-PRI TRANSFORMERS

Quad Port T1/E1 with 8 Transformers, 1500 Vrms



Notes from Electrical Specifications Table

- A. OCL** (primary inductance) is measured at the primary winding. Turns ratio is specified primary: secondary. (CT = Center Tap).
- B. To make a 1CT:1** ratio from a 1CT:2CT ratio, use only one-half of the secondary (2CT) winding.
- C. It is possible** to use the same transformer model for the three impedance levels of T1 (100 W) and CEPT (75 Ω & 120 Ω). For specific connection information and resistor values, refer to IC vendor's data book.
- D. Dual Ratio Transformer** (T1071NL and T1145NL) — These transformers have tapped secondary windings to provide two turns ratios (T/R). Use the entire primary winding and connect the secondary pins listed below to obtain desired turns ratio:

| Part Number | Turns Ratio 1 | Secondary Pins | Turns Ratio 2 | Secondary Pins |
|-------------|---------------|----------------|---------------|----------------|
| T1071NL | 1:1 | 40-39 | 1:1.26 | 40-38 |
| | 1:1 | 35-34 | 1:1.26 | 35-33 |
| | 1:1 | 30-29 | 1:1.26 | 30-28 |
| | 1:1 | 25-24 | 1:1.26 | 25-23 |
| T1145NL | 1:2 | 40-39 | 1:2.4 | 40-38 |
| | 1:2 | 33-32 | 1:2.4 | 33-31 |
| | 1:2 | 30-29 | 1:2.4 | 30-28 |
| | 1:2 | 23-22 | 1:2.4 | 23-21 |

- E. Standard packaging** for the surface mount package is anti-static tubes. Optional Tape & Reel packaging can be ordered by adding a "T" suffix to the part number, (i.e. T1063NL**T**).
- F. Extended Temperature Range Models** — For extended temperature range transformers (-40°C to +85°C operating temperature range), OCL (Open Circuit Inductance) for the primary winding is specified at both -40°C and +25°C. At -40°C, OCL is 600 μH minimum. All other parameters are specified at +25°C only. Standard temperature range is 0°C to +70°C

Schematics

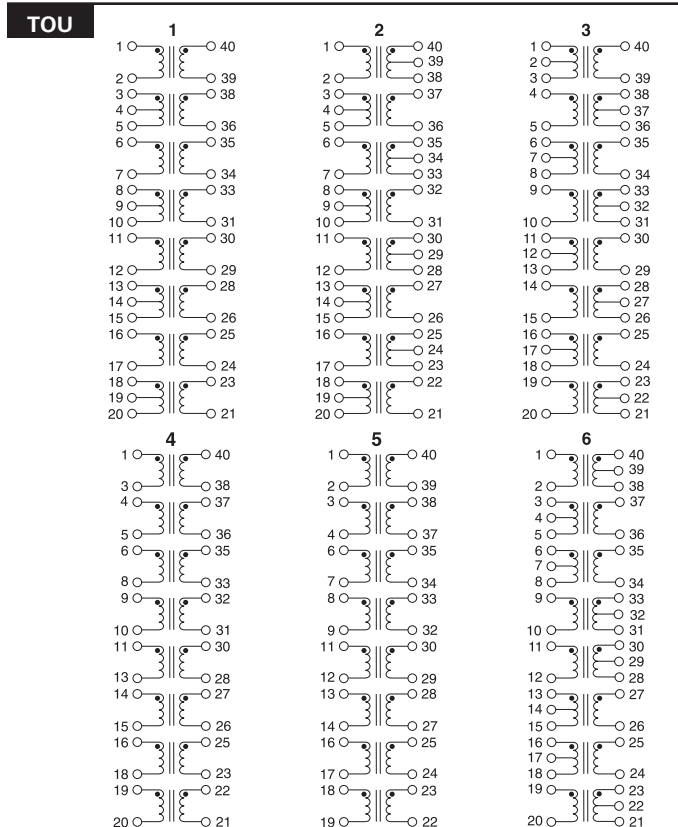

Transformer Selection Guide

| IC Mfr. | IC Part Number | Comments | Octal SMT | |
|---------------------------------------|---------------------------|-------------|-----------|----------|
| | | | STD Temp | EXT Temp |
| Mindspeed (Conexant) | BT8510 | T1/E1 | T1071NL | — |
| | BT8510 | T1/E1 | T1071NL | — |
| | CN8380 | | T1124NL | T1114NL |
| Cirrus Logic (Crystal) | 61318 | 120 E1 | T1068NL | T1108NL |
| | 61577 | T1 & E1 | T1065NL | T1105NL |
| | 61304A/5A/535A/574A,/75 | 75 E1 | T1068NL | T1108NL |
| | 61304A/5A/535A/574A,/75 | 120 E1 | T1071NL | — |
| | 61582, 61583 | | T1064NL | — |
| | 61310, 61581 | | T1068NL | T1108NL |
| | 61584/84A | IQ3 | T1065NL | T1105NL |
| 61584/82/83/A | IQ5 | T1064NL | — | |
| Maxim (Dallas) | DS2196 | | T1068NL | T1108NL |
| | DS2148/Q48 | 3V | T1068NL | T1108NL |
| | DS21352/Q352,DS21354/Q354 | | T1068NL | T1108NL |
| Exar | T5683A, 59L91 | | T1065NL | T1105NL |
| | T5894, T5897, T5997 | | T1065NL | T1105NL |
| | T5791/93/94/95 | | T1071NL | — |
| | 83L30/34/38 | | T1065NL | T1105NL |
| Infineon Technologies (Siemens) | PEB 22504 | 3.3V | T1142NL | T1231NL |
| | PEB22554 | 3.3V | T1142NL | T1231NL |
| | PEB2256 3.3 V | E1/T1/J1 | T1142NL | T1231NL |
| Intel (Level One) | LXT 300/301 | | T1065NL | T1105NL |
| | LXT 304/305/307 | T1,E1 | T1065NL | T1105NL |
| | LXT 304/305/307 | 75 E1,120E1 | T1071NL | — |
| | LXT 310/317/318 | | T1068NL | T1108NL |
| | LXT 331 | T1,E1 | T1068NL | T1108NL |
| | LXT 331, LXT 332 | | T1065NL | T1105NL |
| | LXT 334, LXT 335 | T1/E1 | T1065NL | T1105NL |
| | LXT 334, LXT 335 | 75 E1 | T1071NL | — |
| | LXT 336 | | T1065NL | T1105NL |
| | LXT 350, LXT 351, LXT 359 | T1,E1 | T1068NL | T1108NL |
| | LXT 360/361/362/363 | T1,E1 | T1068NL | T1108NL |
| | LXT 380/381/384/386/388 | T1/E1 | T1068NL | T1108NL |
| | LXT 380/381/384/386/388 | T1/E1 | T1124NL | T1114NL |
| LXT 3104, LXT 3108 | | T1068NL | T1108NL | |
| Lucent Technologies | T7688, T7690, T7698 | CEPT | T1063NL | — |
| | T7689, T7690, T7698 | DS1 | T1064NL | — |
| | TLIU04C1 | DS1 | T1064NL | — |
| | TLIU04C1 | CEPT | T1063NL | — |
| Zarlink (Mitel) | MT9076, MT9075 | | T1142NL | T1231NL |
| | MT9074, MT9075 | | T1068NL | T1108NL |
| PMC Sierra | PM4318 | | T1065NL | T1105NL |

T1/E1/CEPT/ISDN-PRI TRANSFORMERS

Quad Port T1/E1 with 8 Transformers, 1500 Vrms



Application Notes

1. **ET Product** — All coils have an ET product of 10 V- μ sec minimum.
2. **Flammability** — Materials used in the products are recognized as UL94-VO approved. Products meet the IEC 695-2-2 requirements (Needle Flame Test).
3. **Balance Characteristics** — The transformers meet the requirements for longitudinal balance of FCC part 68.
4. **Common Mode Rejection Ratio** — the CMRR for all transformers is better than 50dB at 1MHz. A typical test circuit is shown below.

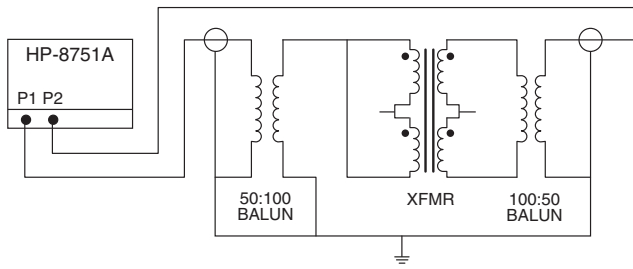

5. **Crosstalk Attenuation** — In the packages which contain transmit and receive transformers side by side, sufficient crosstalk attenuation is achieved by the inherent characteristics of the toroid cores as well as by their proper positioning. The crosstalk attenuation is typically 65 dB or better. This result was established with the test circuit shown below.

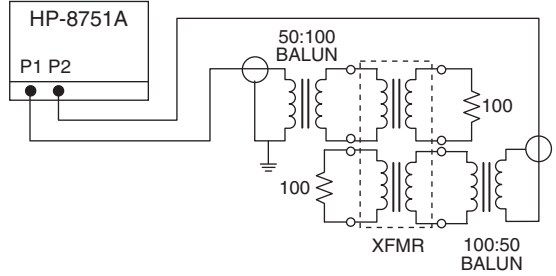

6. **Return Loss** — ITU-T G.703 and European national regulatory documents specify minimum return loss levels. The transformers will allow these limits to be complied within the situations where they are applicable.

| Frequency | 50-100 kHz | 100 kHz-2 MHz | 2-3 MHz |
|-------------|------------|---------------|---------|
| Return Loss | | | |
| Transmit | 9 dB | 15 dB | 11 dB |
| Receive | 12 dB | 18 dB | 14 dB |

7. **Surge Voltage Capability** — All transformers and chokes meet surge voltage tests according to the most stringent regulatory documents, when used with the proper voltage and current suppression devices:
 - Metallic Voltage: 800 V peak, 10/560 μ sec
 - Longitudinal Voltage: 2,400 V peak, 10/700 μ sec

8. **Isolation Voltage** — 100% of transformers are tested during production to

the specified isolation voltage level.

9. **General Information** — The transformers are specifically designed for use in 1.544 Mbps (T1), 2.048 Mbps (CEPT) and ISDN Primary rate (PRI) interface applications. They are matched to the majority of the line interface transceiver ICs currently available. Use of the proper transformer allows the interface circuit to comply with ITU-T G.703 and other standards regarding pulse waveform, return loss, and balance.
10. **Common Mode Chokes** — Additional high-frequency 4-line common mode chokes may be used to provide an effective means of complying with national and international regulations on EMI. The common mode chokes are designed to be used in conjunction with Pulse's T1/CEPT transformers as shown in the typical application below. Crosstalk is typically -65 dB or better.

Typical Application

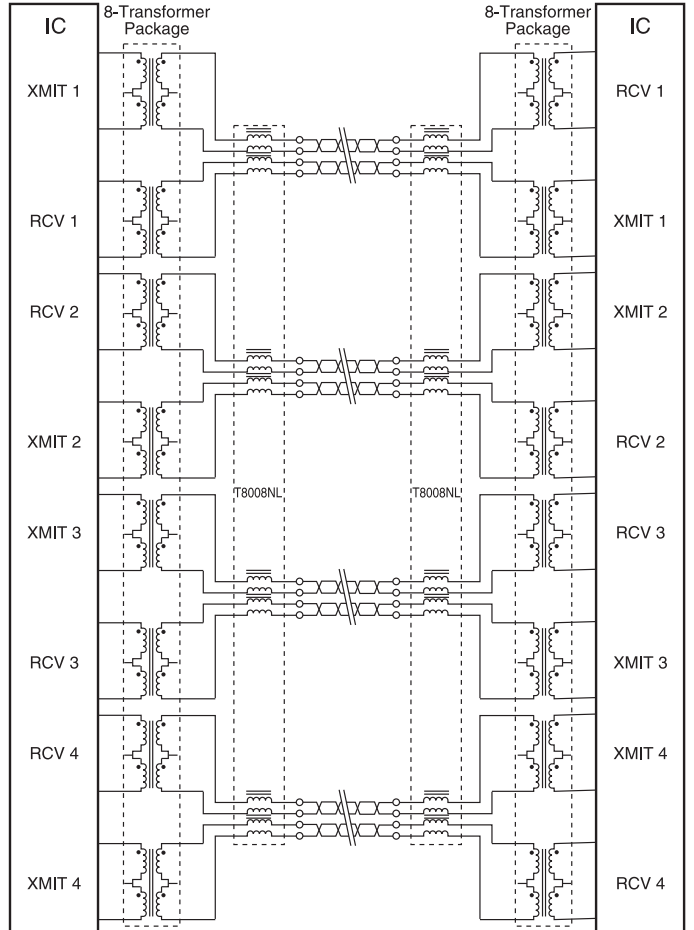

T1/E1/CEPT/ISDN-PRI TRANSFORMERS

Quad Port T1/E1 with 8 Transformers, 1500 Vrms



Electrical Specifications @ 25°C

| RoHS Compliant Part Number | Number of Lines | Turns Ratio (±5%) | OCL (μH MIN) | Cw/w (pF MAX) | LL (μH MAX) | DCR (Ω MAX) | Isolation (Vrms MIN) | Package/Schematic |
|--|-----------------|-------------------|--------------|---------------|-------------|-------------|----------------------|-----------------------|
| HIGH FREQUENCY COMMON MODE CHOKES | | | | | | | | |
| T8008NL* | 16 (8 x 2 line) | 1:1 (8 places) | 47.0 | 25 | .18 | 0.40 | 500 | TOU/2 (Surface Mount) |
| PE-65554NL | 4 | 1:1:1:1 | 24.0 | 15 | .20 | 0.30 | 500 | IN/1 (Through Hole) |
| PE-65555NL | 4 | 1:1:1:1 | 8.0 | 10 | .20 | 0.25 | 500 | IN/1 (Through Hole) |
| PE-65854NL | 4 | 1:1:1:1 | 47.0 | 16 | .20 | 0.30 | 500 | SH/1 (Surface Mount) |
| PE-65857NL | 4 | 1:1:1:1 | 24.0 | 15 | .23 | 0.30 | 500 | LA/1 (Surface Mount) |

*NOTE: Please see page 1 for TOU mechanical specifications.

Schematic

TOU

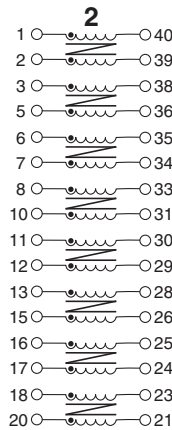

Mechanicals

IN

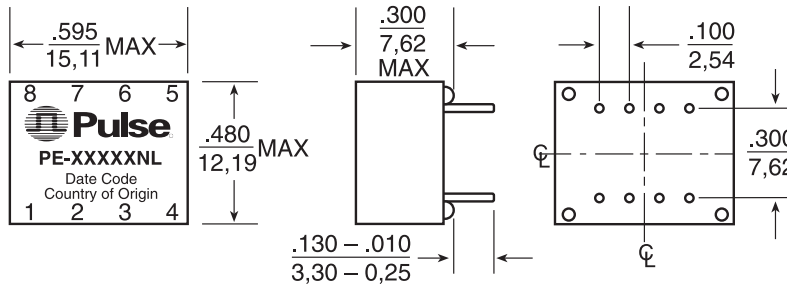

Schematic

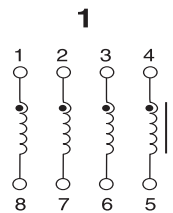

SH

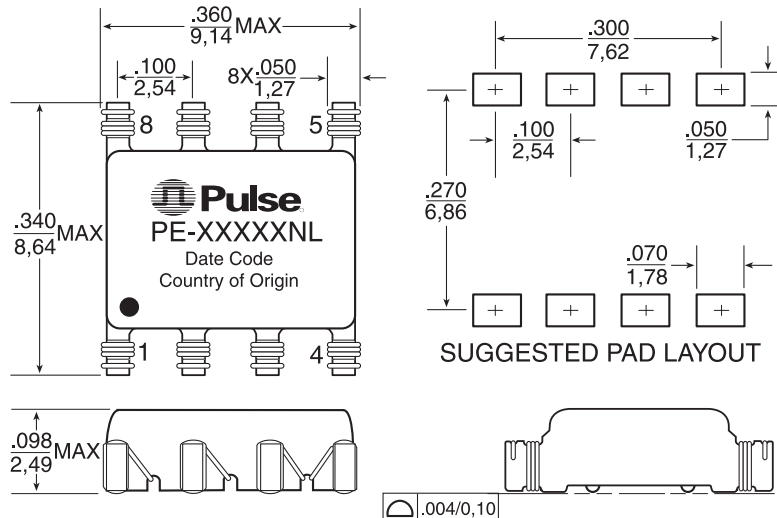

T1/E1/CEPT/ISDN-PRI TRANSFORMERS

Quad Port T1/E1 with 8 Transformers, 1500 Vrms



Mechanical

LA

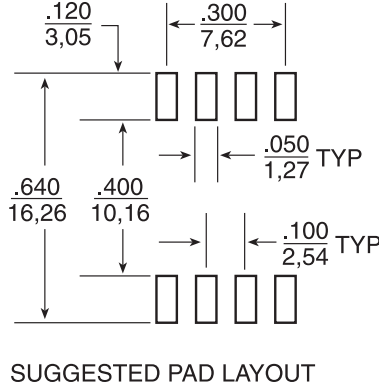
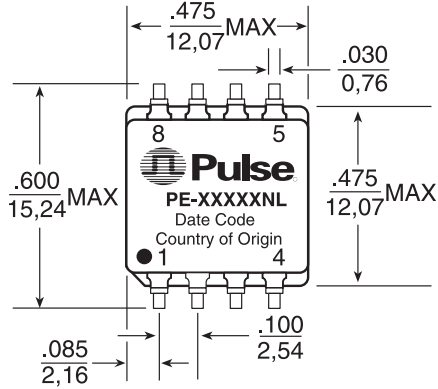

Schematic

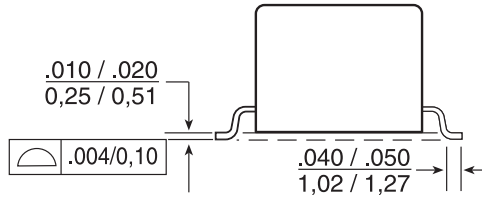
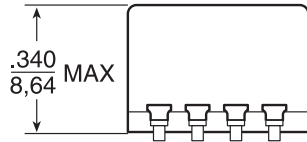
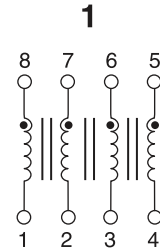

Typical common mode attenuation for high frequency common mode chokes based on a 100 Ω system.

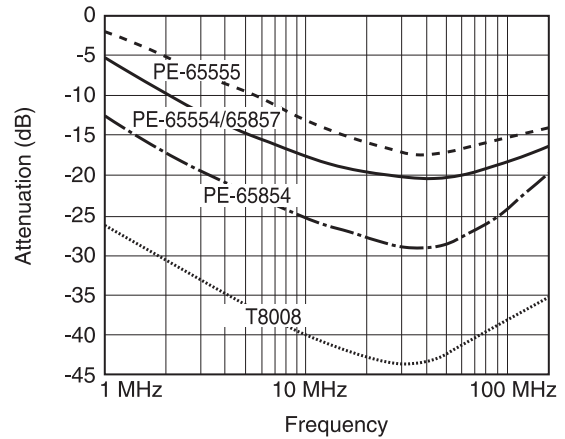

| | SH | LA | IN |
|-------------|-----------|----------|-----------|
| Weight | 0.3 grams | 2 grams | 2.5 grams |
| Tape & Reel | 1500/reel | 250/reel | (N/A) |
| Tube | 25/tube | 30/tube | .35/tube |

Dimensions: $\frac{\text{Inches}}{\text{mm}}$

Unless otherwise specified all tolerances are $\pm \frac{.010}{0,25}$

For More Information:

| Pulse Worldwide Headquarters | Pulse Europe | Pulse China Headquarters | Pulse North China | Pulse South Asia | Pulse North Asia |
|--|--|--|--|---|--|
| 12220 World Trade Dr. San Diego, CA 92128 U.S.A. | Einsteinstrasse 1 D-71083 Herrenberg Germany | B402, Shenzhen Academy of Aerospace Technology Bldg. 10th Kejinan Rd. High-Tech Zone Nanshan District Shenzhen, PR China 518057 | Room 2704/2705 Super Ocean Finance Ctr. 2067 Yan An Rd. West Shanghai 200336 China | 135 Joo Seng Rd. #03-02 PM Industrial Bldg. Singapore 368363 | 3F, No. 198 Zhongyuan Rd. Zhongli City Taoyuan County 320 Taiwan R. O. C. Tel: 886 3 4356768 Fax: FRE 886 3 43568 20 Pulse: 886 3 4356823 |
| www.pulseeng.com Tel: 858 674 8100 Fax: 858 674 8262 | Tel: 49 7032 7806 0 Fax: 49 7032 7806 135 | Tel: 86 755 33966678 Fax: 86 755 33966700 | Tel: 86 21 62787060 Fax: 86 2162786973 | Tel: 65 6287 8998 Fax: 65 6287 8998 | |

Performance warranty of products offered on this data sheet is limited to the parameters specified. Data is subject to change without notice. Other brand and product names mentioned herein may be trademarks or registered trademarks of their respective owners.
© Copyright, 2009. Pulse Engineering, Inc. All rights reserved.

Компания «Life Electronics» занимается поставками электронных компонентов импортного и отечественного производства от производителей и со складов крупных дистрибьюторов Европы, Америки и Азии.

С конца 2013 года компания активно расширяет линейку поставок компонентов по направлению коаксиальный кабель, кварцевые генераторы и конденсаторы (керамические, пленочные, электролитические), за счёт заключения дистрибьюторских договоров

Мы предлагаем:

- Конкуренспособные цены и скидки постоянным клиентам.
- Специальные условия для постоянных клиентов.
- Подбор аналогов.
- Поставку компонентов в любых объемах, удовлетворяющих вашим потребностям.
- Приемлемые сроки поставки, возможна ускоренная поставка.
- Доставку товара в любую точку России и стран СНГ.
- Комплексную поставку.
- Работу по проектам и поставку образцов.
- Формирование склада под заказчика.
- Сертификаты соответствия на поставляемую продукцию (по желанию клиента).
- Тестирование поставляемой продукции.
- Поставку компонентов, требующих военную и космическую приемку.
- Входной контроль качества.
- Наличие сертификата ISO.

В составе нашей компании организован Конструкторский отдел, призванный помогать разработчикам, и инженерам.

Конструкторский отдел помогает осуществить:

- Регистрацию проекта у производителя компонентов.
- Техническую поддержку проекта.
- Защиту от снятия компонента с производства.
- Оценку стоимости проекта по компонентам.
- Изготовление тестовой платы монтаж и пусконаладочные работы.



Тел: +7 (812) 336 43 04 (многоканальный)
Email: org@lifeelectronics.ru