

# T1/E1/CEPT/ISDN-PRI TRANSFORMERS

## Quad Port T1/E1 with 8 Transformers, 1500 Vrms

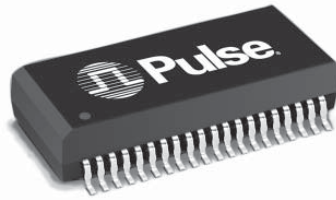

- ⦿ RoHS peak reflow temperature rating 245°C
- ⦿ Models matched to leading quad and dual T1/E1/CEPT/ISDN-PRI transceivers
- ⦿ Crosstalk: -65 dB or better
- ⦿ UL1950 recognized (some parts pending approval)
- ⦿ RoHS compliant versions available upon request

### Electrical Specifications @ 25°C

RoHS Compliant Part Number <sup>C</sup>		Turns Ratio <sup>A, B</sup> (Pri:Sec ±2%)		OCL @ 25°C (mH MIN) <sup>F</sup>		LL (µH MAX)		C <sub>ww</sub> (pF MAX)		Package/ Schematic <sup>E</sup>	Primary Pins	
Std Temp.	Ex Temp <sup>F</sup>	TX	RX	TX	RX	TX	RX	TX	RX		Transmit	Receive
T1063NL	—	1:1.36	1:1.36CT	1.2	1.2	.6	.6	35	35	TOU/1	1-2, 6-7, 11-12, 16-17	38-36, 33-31, 28-26, 23-21
T1064NL	—	1:1.14	1:1.14CT	1.2	1.2	.6	.6	35	35	TOU/1	1-2, 6-7, 11-12, 16-17	38-36, 33-31, 28-26, 23-21
T1065NL	T1105NL	1:2CT	1:2CT	1.2	1.2	.8	.8	35	35	TOU/3	4-5, 9-10, 14-15, 19-20	24-25, 29-30, 34-35, 39-40
T1068NL	T1108NL	1:2CT	1:1CT	1.2	1.2	.6	.6	35	35	TOU/2	1-2, 6-7, 11-12, 16-17	21-22, 26-27, 31-32, 36-37
T1071NL <sup>D</sup>	—	1:1/1.26	1:2CT	1.2	1.2	.6	.6	35	35	TOU/2	1-2, 6-7, 11-12, 16-17	21-22, 26-27, 31-32, 36-37
T1073NL	—	1:2	1:2	1.2	1.2	.6	.6	35	35	TOU/4	1-3, 6-8, 11-13, 16-18	4-5, 9-10, 14-15, 19-20
T1124NL	T1114NL	1:2CT	1CT:2	1.2	1.2	.6	.6	35	35	TOU/3	4-5, 9-10, 14-15, 19-20	1-3, 6-8, 11-13, 16-18
T1129NL	—	1:1.36CT	1:1CT	1.2	1.2	.6	.6	35	35	TOU/3	24-25, 29-30, 34-35, 39-40	4-5, 9-10, 14-15, 19-20
T1142NL	T1231NL	1:2.4	1:1	1.0	1.0	.5	.5	35	35	TOU/5	1-2, 8-9, 11-12, 18-19	24-25, 27-28, 34-35, 37-38
T1145NL <sup>D</sup>	—	1:2/2.4	1:0.79/1	1.0	1.0	1.0	1.0	35	35	TOU/6	1-2, 9-10, 11-12, 19-20	37-36, 35-34, 27-26, 25-24
—	TX1262NL	1:2	1:2	1.2	1.2	.7	.7	35	35	TOU/5	1-2, 6-7, 11-12, 16-17	3-4, 8-9, 13-14, 18-19
—	TX1264NL	1:2CT	1CT:1	1.2	1.2	.6	.6	35	35	TOU/3	4-5, 9-10, 14-15, 19-20	1-3, 6-8, 11-13, 16-18
—	TX1266NL	1:2	1:1	1.2	1.2	.6	.6	35	35	TOU/4	1-3, 6-8, 11-13, 16-18	4-5, 9-10, 14-15, 19-20
—	TX1295NL	1:1.26CT	1:1.26CT	1.2	1.2	.6	.6	35	35	TOU/3	4-5, 9-10, 14-15, 19-20	24-25, 29-30, 34-35, 39-40

NOTE: Chart Notes and TOU Schematics are on page 2.

## Mechanical

### TOU

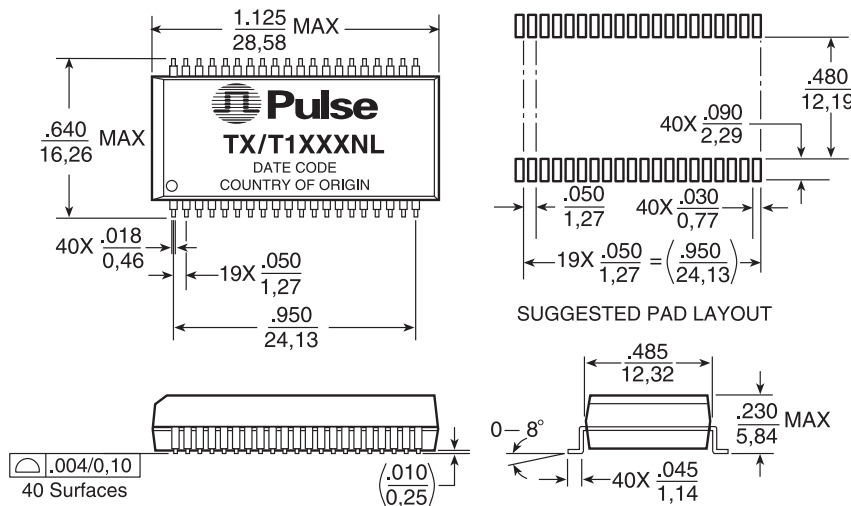

Weight ..... 4.0 grams  
 Tape & Reel ..... 250/reel  
 Tube ..... 15/tube

Dimensions:  $\frac{\text{Inches}}{\text{mm}}$  Unless otherwise specified, all tolerances are  $\pm \frac{.010}{0.25}$

# T1/E1/CEPT/ISDN-PRI TRANSFORMERS

## Quad Port T1/E1 with 8 Transformers, 1500 Vrms



### Notes from Electrical Specifications Table

- A. OCL** (primary inductance) is measured at the primary winding. Turns ratio is specified primary: secondary. (CT = Center Tap).
- B. To make a 1CT:1** ratio from a 1CT:2CT ratio, use only one-half of the secondary (2CT) winding.
- C. It is possible** to use the same transformer model for the three impedance levels of T1 (100 W) and CEPT (75 Ω & 120 Ω). For specific connection information and resistor values, refer to IC vendor's data book.
- D. Dual Ratio Transformer** (T1071NL and T1145NL) — These transformers have tapped secondary windings to provide two turns ratios (T/R). Use the entire primary winding and connect the secondary pins listed below to obtain desired turns ratio:

Part Number	Turns Ratio 1	Secondary Pins	Turns Ratio 2	Secondary Pins
T1071NL	1:1	40-39	1:1.26	40-38
	1:1	35-34	1:1.26	35-33
	1:1	30-29	1:1.26	30-28
	1:1	25-24	1:1.26	25-23
T1145NL	1:2	40-39	1:2.4	40-38
	1:2	33-32	1:2.4	33-31
	1:2	30-29	1:2.4	30-28
	1:2	23-22	1:2.4	23-21

- E. Standard packaging** for the surface mount package is anti-static tubes. Optional Tape & Reel packaging can be ordered by adding a "T" suffix to the part number, (i.e. T1063NL**T**).
- F. Extended Temperature Range Models** — For extended temperature range transformers (-40°C to +85°C operating temperature range), OCL (Open Circuit Inductance) for the primary winding is specified at both -40°C and +25°C. At -40°C, OCL is 600 μH minimum. All other parameters are specified at +25°C only. Standard temperature range is 0°C to +70°C

### Schematics

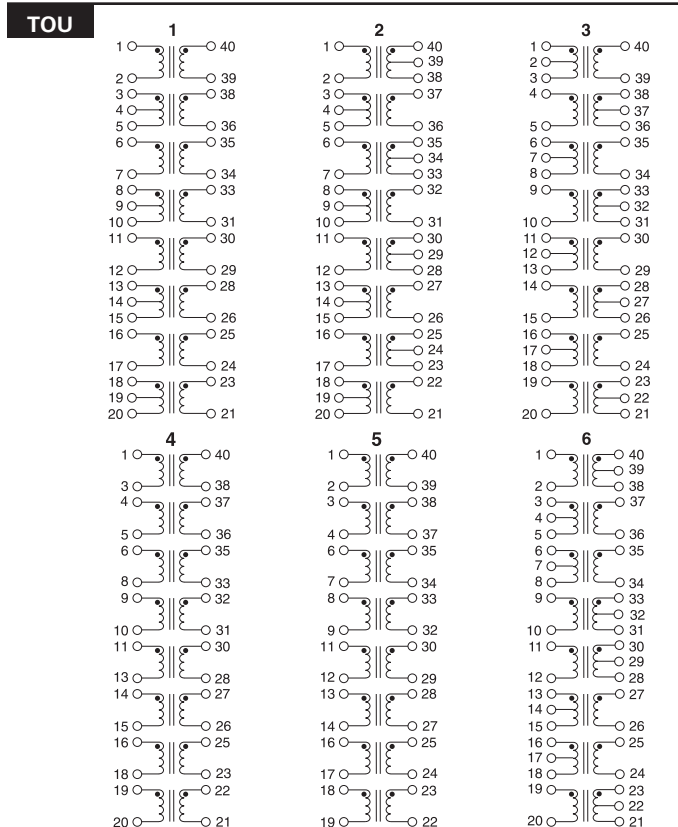

### Transformer Selection Guide

IC Mfr.	IC Part Number	Comments	Octal SMT	
			STD Temp	EXT Temp
Mindspeed (Conexant)	BT8510	T1/E1	T1071NL	—
	BT8510	T1/E1	T1071NL	—
	CN8380		T1124NL	T1114NL
Cirrus Logic (Crystal)	61318	120 E1	T1068NL	T1108NL
	61577	T1 & E1	T1065NL	T1105NL
	61304A/5A/535A/574A,/75	75 E1	T1068NL	T1108NL
	61304A/5A/535A/574A,/75	120 E1	T1071NL	—
	61582, 61583		T1064NL	—
	61310, 61581		T1068NL	T1108NL
	61584/84A	IQ3	T1065NL	T1105NL
61584/82/83/A	IQ5	T1064NL	—	
Maxim (Dallas)	DS2196		T1068NL	T1108NL
	DS2148/Q48	3V	T1068NL	T1108NL
	DS21352/Q352,DS21354/Q354		T1068NL	T1108NL
Exar	T5683A, 59L91		T1065NL	T1105NL
	T5894, T5897, T5997		T1065NL	T1105NL
	T5791/93/94/95		T1071NL	—
	83L30/34/38		T1065NL	T1105NL
Infineon Technologies (Siemens)	PEB 22504	3.3V	T1142NL	T1231NL
	PEB22554	3.3V	T1142NL	T1231NL
	PEB2256 3.3 V	E1/T1/J1	T1142NL	T1231NL
Intel (Level One)	LXT 300/301		T1065NL	T1105NL
	LXT 304/305/307	T1,E1	T1065NL	T1105NL
	LXT 304/305/307	75 E1,120E1	T1071NL	—
	LXT 310/317/318		T1068NL	T1108NL
	LXT 331	T1,E1	T1068NL	T1108NL
	LXT 331, LXT 332		T1065NL	T1105NL
	LXT 334, LXT 335	T1/E1	T1065NL	T1105NL
	LXT 334, LXT 335	75 E1	T1071NL	—
	LXT 336		T1065NL	T1105NL
	LXT 350, LXT 351, LXT 359	T1,E1	T1068NL	T1108NL
	LXT 360/361/362/363	T1,E1	T1068NL	T1108NL
	LXT 380/381/384/386/388	T1/E1	T1068NL	T1108NL
	LXT 380/381/384/386/388	T1/E1	T1124NL	T1114NL
LXT 3104, LXT 3108		T1068NL	T1108NL	
Lucent Technologies	T7688, T7690, T7698	CEPT	T1063NL	—
	T7689, T7690, T7698	DS1	T1064NL	—
	TLIU04C1	DS1	T1064NL	—
	TLIU04C1	CEPT	T1063NL	—
Zarlink (Mitel)	MT9076, MT9075		T1142NL	T1231NL
	MT9074, MT9075		T1068NL	T1108NL
PMC Sierra	PM4318		T1065NL	T1105NL

# T1/E1/CEPT/ISDN-PRI TRANSFORMERS

## Quad Port T1/E1 with 8 Transformers, 1500 Vrms



### Application Notes

1. **ET Product** — All coils have an ET product of 10 V- $\mu$ sec minimum.
2. **Flammability** — Materials used in the products are recognized as UL94-VO approved. Products meet the IEC 695-2-2 requirements (Needle Flame Test).
3. **Balance Characteristics** — The transformers meet the requirements for longitudinal balance of FCC part 68.
4. **Common Mode Rejection Ratio** — the CMRR for all transformers is better than 50dB at 1MHz. A typical test circuit is shown below.

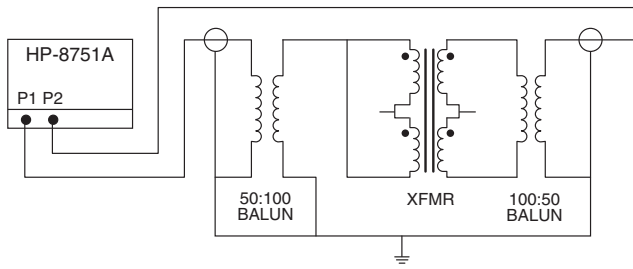

5. **Crosstalk Attenuation** — In the packages which contain transmit and receive transformers side by side, sufficient crosstalk attenuation is achieved by the inherent characteristics of the toroid cores as well as by their proper positioning. The crosstalk attenuation is typically 65 dB or better. This result was established with the test circuit shown below.

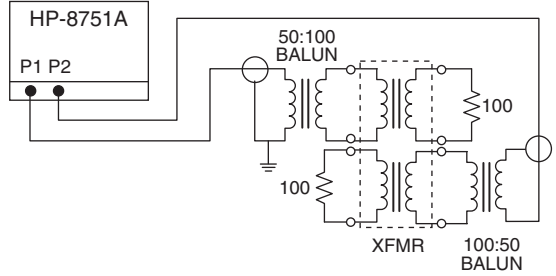

6. **Return Loss** — ITU-T G.703 and European national regulatory documents specify minimum return loss levels. The transformers will allow these limits to be complied within the situations where they are applicable.

Frequency	50-100 kHz	100 kHz-2 MHz	2-3 MHz
Return Loss			
Transmit	9 dB	15 dB	11 dB
Receive	12 dB	18 dB	14 dB

7. **Surge Voltage Capability** — All transformers and chokes meet surge voltage tests according to the most stringent regulatory documents, when used with the proper voltage and current suppression devices:
  - Metallic Voltage: 800 V peak, 10/560 $\mu$ sec
  - Longitudinal Voltage: 2,400 V peak, 10/700 $\mu$ sec

8. **Isolation Voltage** — 100% of transformers are tested during production to

the specified isolation voltage level.

9. **General Information** — The transformers are specifically designed for use in 1.544 Mbps (T1), 2.048 Mbps (CEPT) and ISDN Primary rate (PRI) interface applications. They are matched to the majority of the line interface transceiver ICs currently available. Use of the proper transformer allows the interface circuit to comply with ITU-T G.703 and other standards regarding pulse waveform, return loss, and balance.
10. **Common Mode Chokes** — Additional high-frequency 4-line common mode chokes may be used to provide an effective means of complying with national and international regulations on EMI. The common mode chokes are designed to be used in conjunction with Pulse's T1/CEPT transformers as shown in the typical application below. Crosstalk is typically -65 dB or better.

### Typical Application

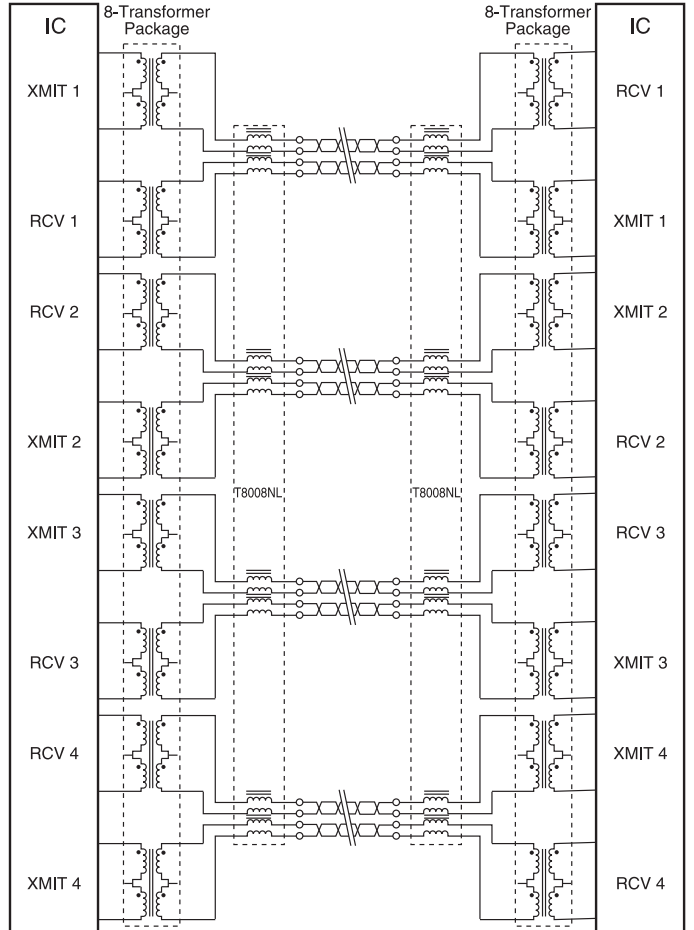

# T1/E1/CEPT/ISDN-PRI TRANSFORMERS

## Quad Port T1/E1 with 8 Transformers, 1500 Vrms



### Electrical Specifications @ 25°C

RoHS Compliant Part Number	Number of Lines	Turns Ratio (±5%)	OCL (μH MIN)	Cw/w (pF MAX)	LL (μH MAX)	DCR (Ω MAX)	Isolation (Vrms MIN)	Package/Schematic
<b>HIGH FREQUENCY COMMON MODE CHOKES</b>								
T8008NL*	16 (8 x 2 line)	1:1 (8 places)	47.0	25	.18	0.40	500	TOU/2 (Surface Mount)
PE-65554NL	4	1:1:1:1	24.0	15	.20	0.30	500	IN/1 (Through Hole)
PE-65555NL	4	1:1:1:1	8.0	10	.20	0.25	500	IN/1 (Through Hole)
PE-65854NL	4	1:1:1:1	47.0	16	.20	0.30	500	SH/1 (Surface Mount)
PE-65857NL	4	1:1:1:1	24.0	15	.23	0.30	500	LA/1 (Surface Mount)

\*NOTE: Please see page 1 for TOU mechanical specifications.

### Schematic

#### TOU

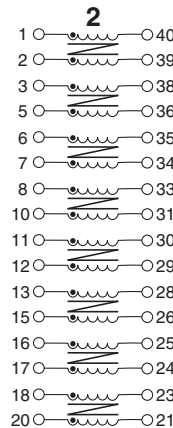

### Mechanicals

#### IN

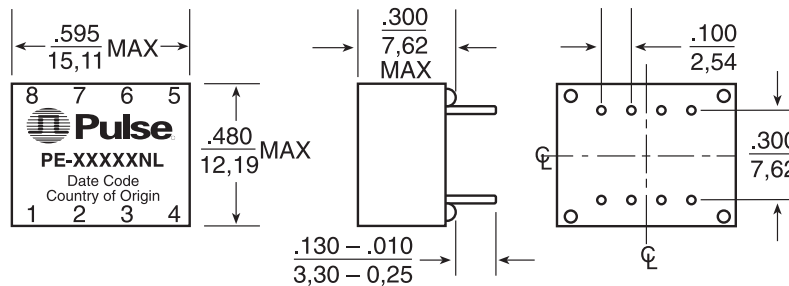

### Schematic

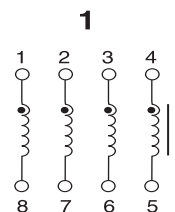

#### SH

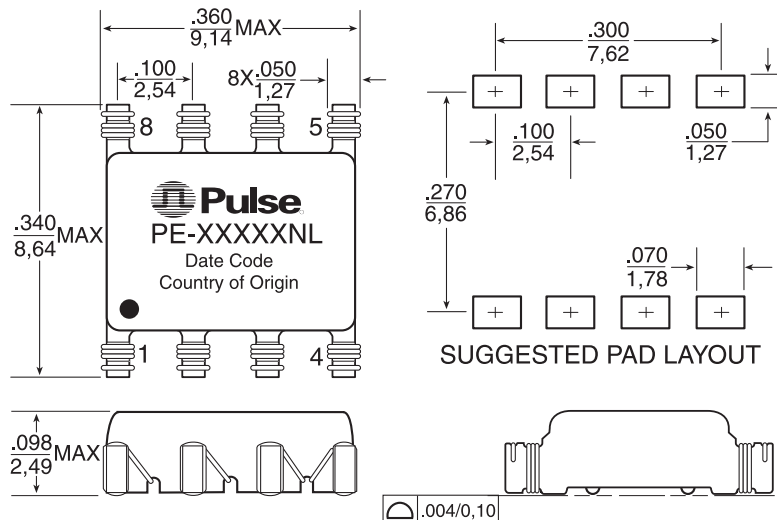

# T1/E1/CEPT/ISDN-PRI TRANSFORMERS

## Quad Port T1/E1 with 8 Transformers, 1500 Vrms



### Mechanical

**LA**

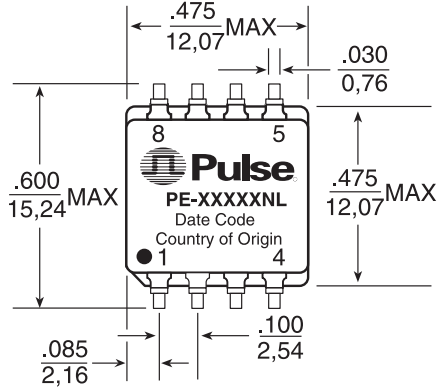

### Schematic

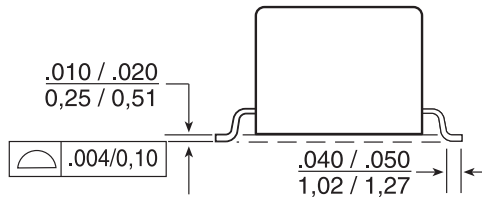
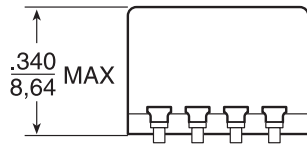

Typical common mode attenuation for high frequency common mode chokes based on a 100 Ω system.



	SH	LA	IN
Weight	0.3 grams	2 grams	2.5 grams
Tape & Reel	1500/reel	250/reel	(N/A)
Tube	25/tube	30/tube	.35/tube

Dimensions:  $\frac{\text{Inches}}{\text{mm}}$   
 Unless otherwise specified all tolerances are  $\pm \frac{.010}{0,25}$

### For More Information:

Pulse Worldwide Headquarters	Pulse Europe	Pulse China Headquarters	Pulse North China	Pulse South Asia	Pulse North Asia
12220 World Trade Dr. San Diego, CA 92128 U.S.A.	Einsteinstrasse 1 D-71083 Herrenberg Germany	B402, Shenzhen Academy of Aerospace Technology Bldg. 10th Kejinan Rd. High-Tech Zone Nanshan District Shenzhen, PR China 518057	Room 2704/2705 Super Ocean Finance Ctr. 2067 Yan An Rd. West Shanghai 200336 China	135 Joo Seng Rd. #03-02 PM Industrial Bldg. Singapore 368363	3F, No. 198 Zhongyuan Rd. Zhongli City Taoyuan County 320 Taiwan R. O. C. Tel: 886 3 4356768 Fax: FRE 886 3 43568 20 Pulse: 886 3 4356823
<a href="http://www.pulseeng.com">www.pulseeng.com</a> Tel: 858 674 8100 Fax: 858 674 8262	Tel: 49 7032 7806 0 Fax: 49 7032 7806 135	Tel: 86 755 33966678 Fax: 86 755 33966700	Tel: 86 21 62787060 Fax: 86 2162786973	Tel: 65 6287 8998 Fax: 65 6287 8998	

Performance warranty of products offered on this data sheet is limited to the parameters specified. Data is subject to change without notice. Other brand and product names mentioned herein may be trademarks or registered trademarks of their respective owners.  
 © Copyright, 2009. Pulse Engineering, Inc. All rights reserved.

Компания «Life Electronics» занимается поставками электронных компонентов импортного и отечественного производства от производителей и со складов крупных дистрибьюторов Европы, Америки и Азии.

С конца 2013 года компания активно расширяет линейку поставок компонентов по направлению коаксиальный кабель, кварцевые генераторы и конденсаторы (керамические, пленочные, электролитические), за счёт заключения дистрибьюторских договоров

Мы предлагаем:

- Конкуренспособные цены и скидки постоянным клиентам.
- Специальные условия для постоянных клиентов.
- Подбор аналогов.
- Поставку компонентов в любых объемах, удовлетворяющих вашим потребностям.
- Приемлемые сроки поставки, возможна ускоренная поставка.
- Доставку товара в любую точку России и стран СНГ.
- Комплексную поставку.
- Работу по проектам и поставку образцов.
- Формирование склада под заказчика.
- Сертификаты соответствия на поставляемую продукцию (по желанию клиента).
- Тестирование поставляемой продукции.
- Поставку компонентов, требующих военную и космическую приемку.
- Входной контроль качества.
- Наличие сертификата ISO.

В составе нашей компании организован Конструкторский отдел, призванный помогать разработчикам, и инженерам.

Конструкторский отдел помогает осуществить:

- Регистрацию проекта у производителя компонентов.
- Техническую поддержку проекта.
- Защиту от снятия компонента с производства.
- Оценку стоимости проекта по компонентам.
- Изготовление тестовой платы монтаж и пусконаладочные работы.



Тел: +7 (812) 336 43 04 (многоканальный)  
Email: [org@lifeelectronics.ru](mailto:org@lifeelectronics.ru)