

### Product Overview

The TQL9063 is a high-linearity, ultra-low noise gain block amplifier with a bypass mode functionality integrated in the product. At 1.95 GHz, the amplifier typically provides 19 dB gain, +36.3 dBm OIP3, and 0.7 dB noise figure while drawing 77 mA current from a +5 V supply. The component also provides high linearity in the bypass mode with +39 dBm IIP3.

The TQL9063 is internally matched using a high-performance E-pHEMT process and only requires four external components for operation from a single positive supply: an external RF choke and blocking/bypass capacitors. This low noise amplifier contains an internal active bias to maintain high performance over temperature.

The TQL9063 covers the 0.5 – 4.0 GHz frequency band and is targeted for wireless infrastructure. The TQL9063 is packaged in a 2 x 2 mm DFN.

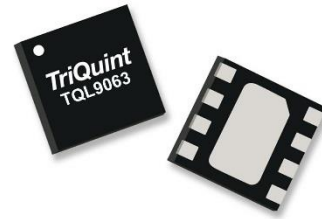

8-pin 2x2 mm DFN Package

### Key Features

- 0.5 – 4.0 GHz Operational bandwidth
- LNA with integrated bypass mode
- Ability to turn LNA and bypass mode OFF
- Ultra low noise, 0.7 dB at 1.95 GHz
- 19 dB Gain at 1.95 GHz
- +36.3 dBm Output IP3 in LNA Mode
- +39 dBm Input IP3 in Bypass Mode
- Internally matched
- Positive supply only, +3.3 to +5 V
- 2x2 mm 8-pin DFN plastic package

### Functional Block Diagram

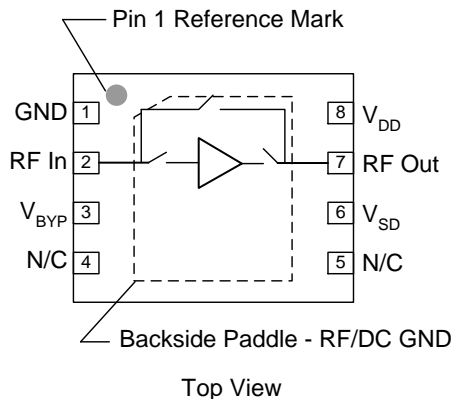

### Applications

- Base Station Receivers
- Tower Mount Amplifiers
- Repeaters
- FDD-LTE, TDD-LTE, WCDMA
- General Purpose Wireless

### Ordering Information

Part No.	Description
TQL9063	500–4000 MHz Bypass LNA
TQL9063-PCB	500–4000 MHz Evaluation Board

Standard T/R size = 2500 pieces on a 7" reel

## Absolute Maximum Ratings

Parameter	Rating
Storage Temperature	-65 to 150 °C
RF Input Power, CW, 50 Ω, T=+25 °C	+22 dBm
Device Voltage (V <sub>DD</sub> )	+7 V

Operation of this device outside the parameter ranges given above may cause permanent damage.

## Recommended Operating Conditions

Parameter	Min	Typ	Max	Units
Device Voltage (V <sub>CC</sub> )	+3.3	+5.0	+5.25	V
T <sub>CASE</sub>	-40		+105	°C
T <sub>j</sub> for >10 <sup>6</sup> hours MTTF			+190	°C

Electrical specifications are measured at specified test conditions. Specifications are not guaranteed over all recommended operating conditions.

## Electrical Specifications

Test conditions unless otherwise noted: V<sub>DD</sub> = +5 V, Temp.=+25°C.

Parameter	Conditions	Min	Typ	Max	Units
Operational Frequency Range		500		4000	MHz
Test Frequency			1950		MHz
Gain	LNA ON, Bypass OFF	17.5	19	20.5	dB
Input Return Loss	LNA ON, Bypass OFF		12		dB
Output Return Loss	LNA ON, Bypass OFF		9.5		dB
Noise Figure	LNA ON, Bypass OFF		0.7	0.9	dB
Output P1dB	LNA ON, Bypass OFF		+21.2		dBm
Output IP3	LNA ON, Bypass OFF, P <sub>out</sub> =+0 dBm/tone, Δf=1 MHz	+31	+36.3		dBm
Insertion Loss	LNA OFF, Bypass ON		1.4		dB
Return Loss	LNA OFF, Bypass ON		18		dB
Input IP3	LNA OFF, Bypass ON P <sub>in</sub> =+3 dBm/tone, Δf=1 MHz		+39		dBm
Isolation	LNA OFF, Bypass OFF		17		dB
Control Voltage, V <sub>1</sub> , V <sub>2</sub> <sup>(1)</sup>	V <sub>IH</sub>	1.6		V <sub>DD</sub>	V
	V <sub>IL</sub>	0		0.5	V
Current, I <sub>D</sub>	Bypass OFF	60	77	100	mA
	Bypass ON		3		mA
Switching Speed <sup>(2)</sup>	Bypass to LNA Mode		983		ns
	LNA to Bypass Mode		1.9		μs
	LNA to OFF		200		ns
Thermal Resistance, θ <sub>Jc</sub>	Channel to case		44		°C/W

Notes:

1. These voltages are reference at the turrets labelled V1 and V2 on the circuit schematic on page 3.
2. To achieve these fast switching speeds it is required to place a 91K shunt resistor at the RFout pin 7. Refer pg. 6.

## Control Truth Table

V <sub>BYP</sub>	V <sub>SD</sub>	State
0	0	LNA ON, Bypass OFF
0	1	LNA OFF, Bypass OFF
1	x	LNA OFF, Bypass ON

## De-embedded S-Parameters (LNA Mode)

Test Conditions:  $V_{DD}=+5\text{ V}$ ,  $I_{DD}=75\text{ mA}$  (typ.),  $T=+25^{\circ}\text{C}$ , unmatched 50 ohm system, calibrated to device leads

Freq (GHz)	S11 (dB)	S11 (ang)	S21 (dB)	S21 (ang)	S12 (dB)	S12 (ang)	S22 (dB)	S22 (ang)
0.1	-0.34	-18.46	10.47	-40.24	-49.61	153.06	-0.20	-49.20
0.3	-2.46	-56.16	25.14	-126.62	-33.50	92.83	-4.56	-154.92
0.4	-4.03	-65.89	26.03	-156.47	-31.84	74.30	-8.52	162.29
0.6	-5.84	-77.87	25.55	166.99	-30.62	57.06	-14.43	89.93
0.7	-6.38	-83.02	25.03	154.63	-30.24	52.96	-15.50	58.24
0.8	-6.80	-87.84	24.47	144.39	-29.91	50.25	-15.55	32.10
1	-7.45	-96.37	23.34	127.97	-29.31	47.05	-14.41	-4.20
1.2	-7.92	-103.39	22.23	114.95	-28.74	45.37	-13.04	-27.33
1.3	-8.11	-106.38	21.70	109.30	-28.47	44.80	-12.41	-36.16
1.4	-8.27	-109.05	21.18	104.07	-28.20	44.35	-11.83	-43.80
1.5	-8.41	-111.43	20.67	99.21	-27.93	43.96	-11.30	-50.53
1.6	-8.52	-113.55	20.18	94.65	-27.67	43.62	-10.81	-56.56
1.7	-8.62	-115.44	19.69	90.36	-27.42	43.31	-10.36	-62.02
1.8	-8.71	-117.11	19.23	86.30	-27.17	43.01	-9.95	-67.01
1.9	-8.78	-118.58	18.77	82.44	-26.92	42.72	-9.57	-71.62
2	-8.83	-119.88	18.33	78.75	-26.68	42.42	-9.22	-75.91
2.1	-8.88	-121.03	17.90	75.22	-26.45	42.13	-8.90	-79.92
2.2	-8.91	-122.03	17.48	71.83	-26.22	41.83	-8.60	-83.70
2.3	-8.93	-122.92	17.07	68.57	-26.00	41.51	-8.33	-87.26
2.4	-8.94	-123.69	16.66	65.42	-25.78	41.19	-8.08	-90.64
2.5	-8.94	-124.36	16.27	62.37	-25.56	40.86	-7.85	-93.86
2.6	-8.92	-124.95	15.89	59.42	-25.35	40.52	-7.64	-96.93
2.7	-8.91	-125.47	15.52	56.55	-25.15	40.17	-7.45	-99.87
2.8	-8.88	-125.92	15.15	53.76	-24.95	39.81	-7.27	-102.69
3	-8.80	-126.67	14.45	48.39	-24.56	39.06	-6.97	-108.03
3.2	-8.69	-127.26	13.77	43.26	-24.18	38.26	-6.73	-113.00
3.4	-8.56	-127.74	13.12	38.32	-23.82	37.41	-6.53	-117.68
3.6	-8.41	-128.16	12.50	33.56	-23.46	36.52	-6.39	-122.10
3.8	-8.24	-128.54	11.90	28.94	-23.12	35.57	-6.30	-126.30
4	-8.05	-128.93	11.32	24.43	-22.78	34.56	-6.26	-130.29

## Noise Parameters (LNA Mode)

Test conditions unless otherwise noted:  $V_{DD}=+5\text{ V}$ ,  $I_{DD}=75\text{ mA}$  (typ.),  $\text{Temp}=+25^{\circ}\text{C}$ , 50 Ohm system

Freq (GHz)	NF <sub>min</sub> (dB)	GammaOpt (mag)	GammaOpt (deg)	Rn (Ω)
1.5	0.46	0.27	73.07	3.17
1.6	0.47	0.27	76.39	3.15
1.7	0.47	0.28	79.57	3.14
1.8	0.48	0.28	82.63	3.12
1.9	0.49	0.29	85.57	3.11
2	0.50	0.29	88.39	3.10
2.1	0.50	0.30	91.10	3.08
2.2	0.51	0.31	93.70	3.07
2.3	0.52	0.31	96.20	3.06
2.4	0.53	0.32	98.60	3.04
2.5	0.54	0.33	100.91	3.03
2.6	0.55	0.33	103.13	3.02
2.7	0.56	0.34	105.27	3.00

**TQL9063-PCB Evaluation Board**

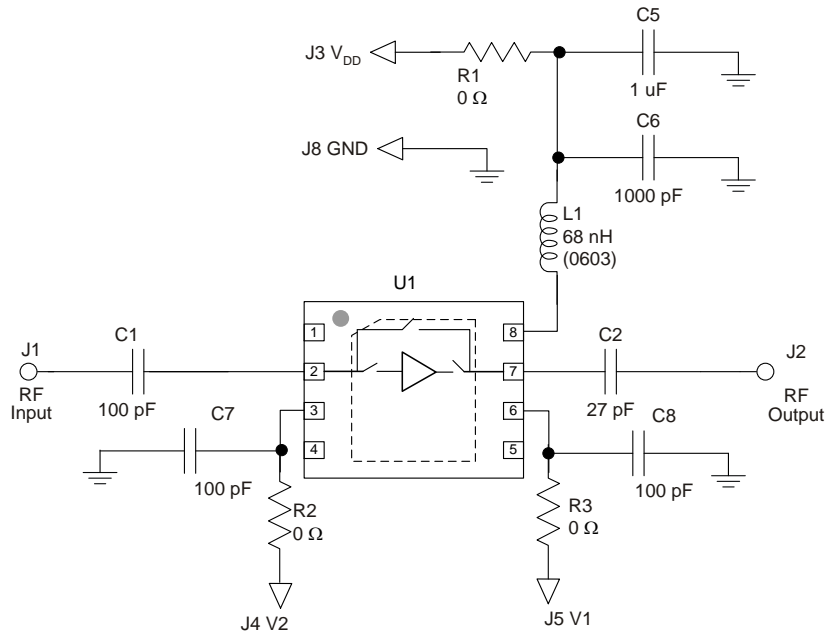
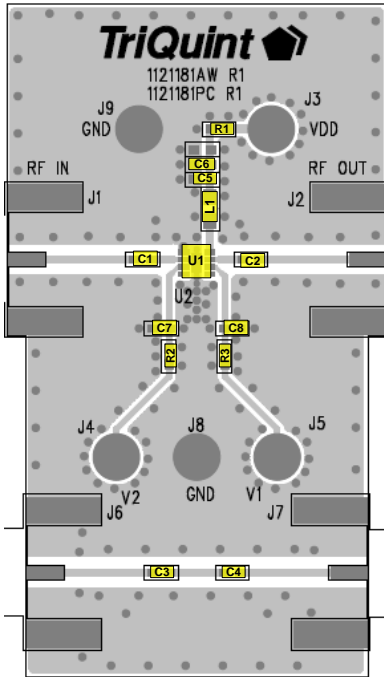

See Evaluation Board PCB Information section for PCB material and stack-up.

**Bill of Material – TQL9063-PCB**

Reference Des.	Value	Description	Manuf.	Part Number
U1	n/a	Bypass LNA	Qorvo	TQL9063
C2	27 pF	CAP, chip, 0402	Various	
C1, C3, C4, C7, C8	100 pF	CAP, 0402, +/-5%, 50V	Panasonic	ECJ-0EC1H101J
C6	1000 pF	CAP, 0402	various	
C5	1.0 uF	Cap., Chip, 0402, 10%, 10V, X5R	various	
R1, R2, R3	0 Ω	RES, 0402, +/-5%, 1/10W	various	
L1	68 nH	IND, 0603, +/-5%	Coilcraft	0603CS-68NXJL

### Typical Performance (LNA Mode)

Test conditions unless otherwise noted:  $V_{DD} = +5\text{ V}$ ,  $V_1 = 0.5\text{ V}$ ,  $V_2 = 0.5\text{ V}$ ,  $I_D = 77\text{ mA}$ ,  $\text{Temp.} = +25\text{ }^\circ\text{C}$ .

Parameter	Typical Value				Units
Frequency	700	1950	2600	3500	MHz
Gain	+24.3	19.2	17.3	14	dB
Noise Figure	0.64	0.7	0.8	1.1	dB
Input Return Loss	7.8	12	15.3	13.7	dB
Output Return Loss	9.4	9.3	9.5	6	dB
OIP3 (Pout/tone=+0 dBm, $\Delta f = 1\text{ MHz}$ )	+35.5	+36.3	+36.1	+36.4	dBm
P1dB	+21.7	+21.2	+21.6	+19.8	dBm

### Typical Performance (Bypass Mode)

Test conditions unless otherwise noted:  $V_{DD} = +5\text{ V}$ ,  $V_1 = 0.5\text{ V}$  or  $1.6\text{ V}$ ,  $V_2 = 1.6\text{ V}$ ,  $I_d = 3\text{ mA}$ ,  $\text{Temp.} = +25\text{ }^\circ\text{C}$ .

Parameter	Typical Value				Units
Frequency	700	1950	2600	3500	MHz
Insertion Loss	1.2	1.4	1.5	1.6	dB
Input Return Loss	13.6	20	25	20	dB
Output Return Loss	13.6	18	18	17	dB
Input IP3 (Pin/tone=+3 dBm, $\Delta f = 1\text{ MHz}$ )	+38.2	+39	+39	+36.6	dBm

### Typical Performance (LNA OFF, Bypass OFF Mode)

Test conditions unless otherwise noted:  $V_{DD} = +5\text{ V}$ ,  $V_1 = 1.6\text{ V}$ ,  $V_2 = 0.5\text{ V}$ ,  $\text{Temp.} = +25\text{ }^\circ\text{C}$ .

Parameter	Typical Value				Units
Frequency	700	1950	2600	3500	MHz
Isolation	23	17	15	15	dB

## Performance Plots

Test conditions unless otherwise noted:  $V_{DD} = +5\text{ V}$

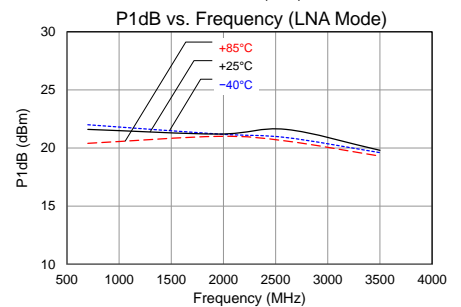
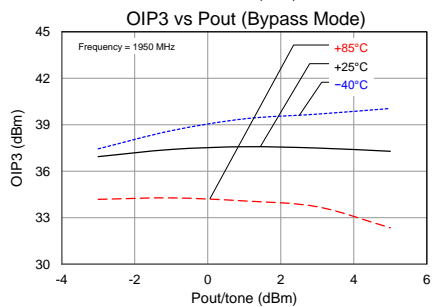
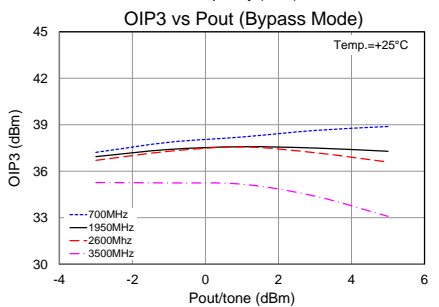
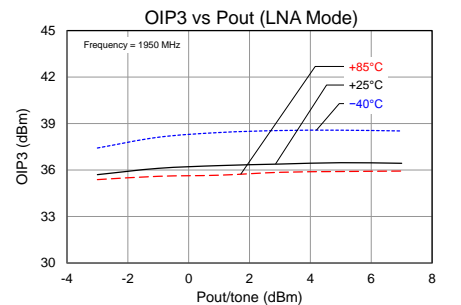
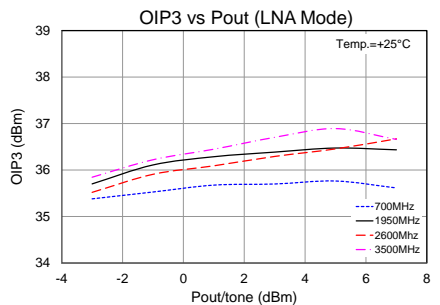
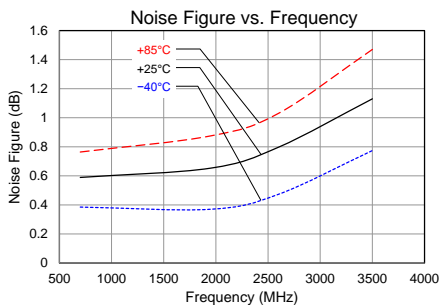
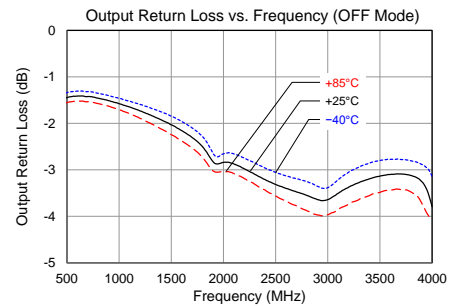
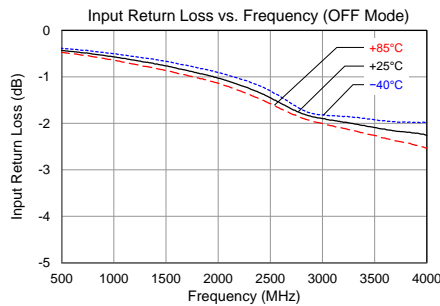
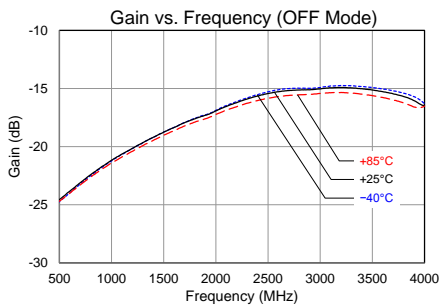
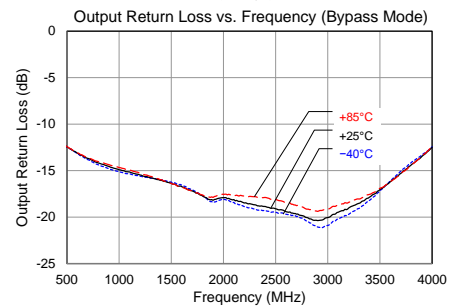
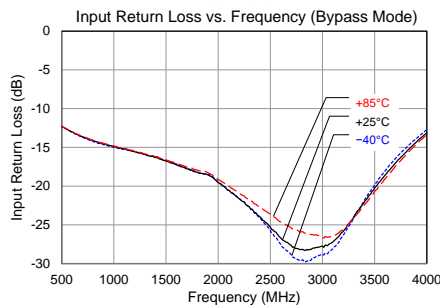
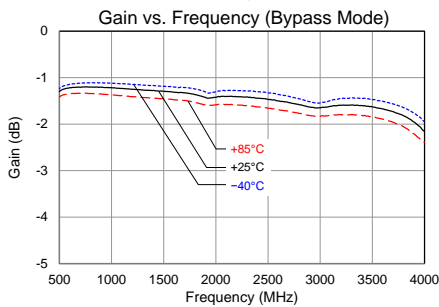
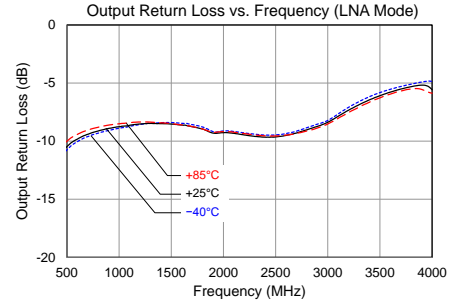
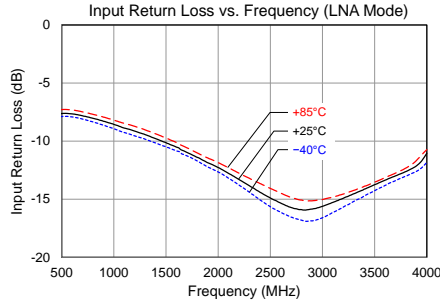
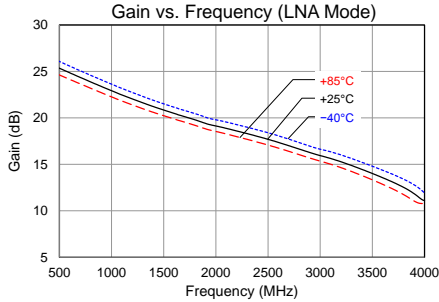

Switching Speed

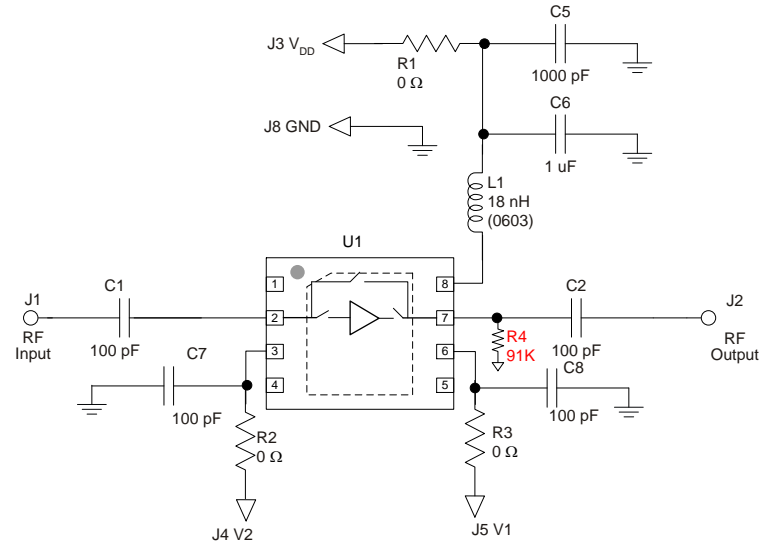
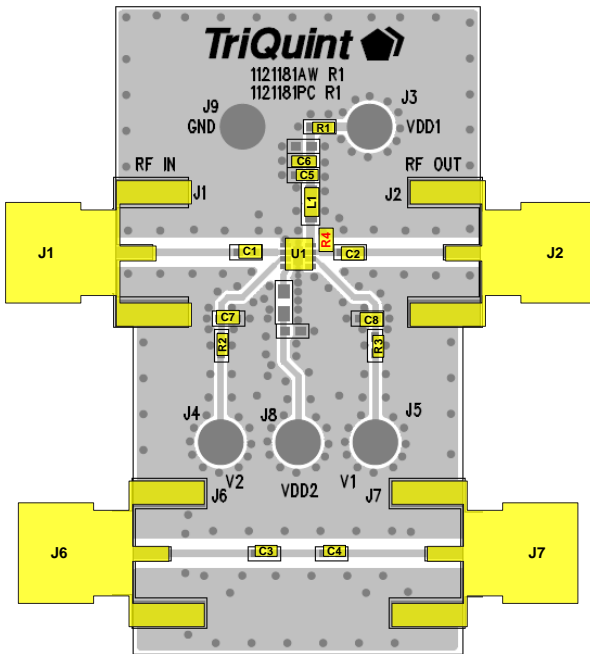

Transition	Value	Units
Bypass to LNA mode	983	ns
LNA to Bypass mode	1.9	μs

R4, valued 91K, is required to achieve the fast switching speeds listed above. The placement of R4 is shown on the Qorvo EVB above.

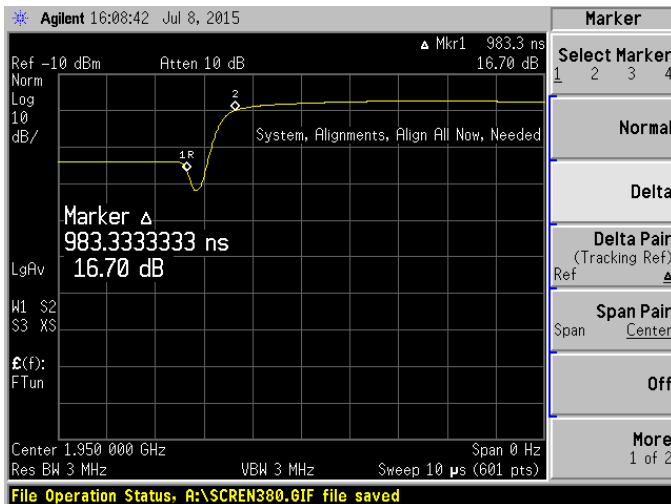

Bypass to LNA mode transition

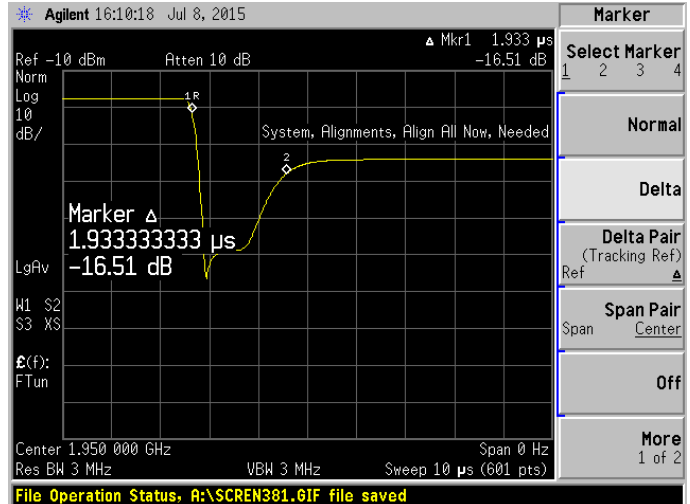

LNA to Bypass mode transition

## TQL9063 – Optimized Return Loss Tune

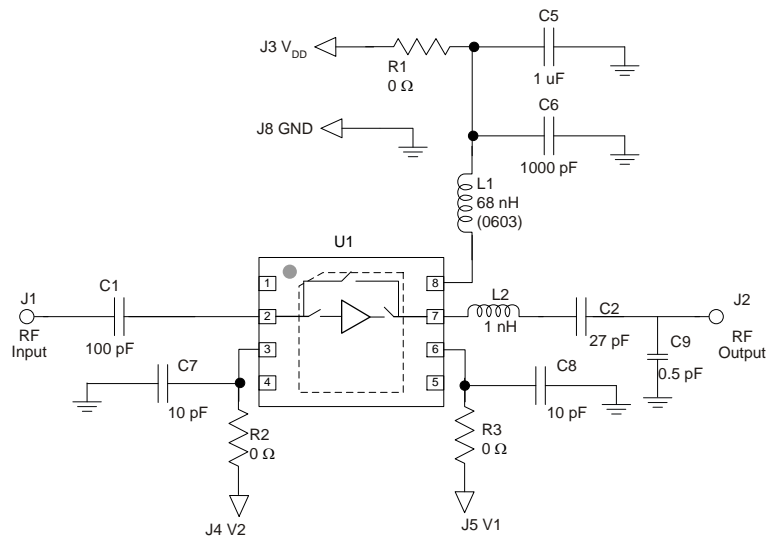
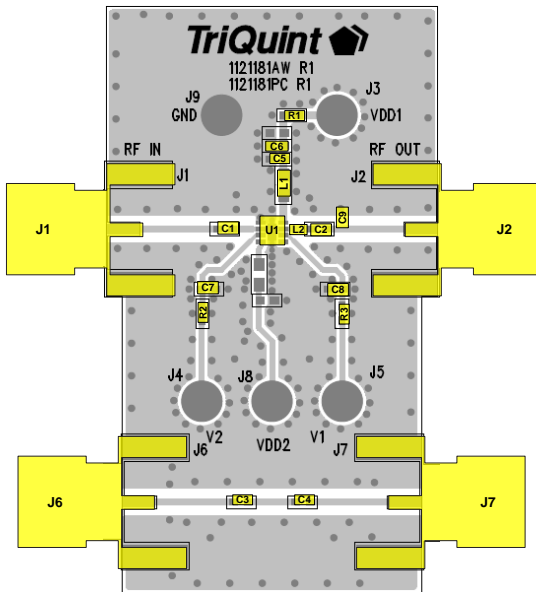

See Evaluation Board PCB Information section for PCB material and stack-up.

## Bill of Material – Optimized Return Loss Tune

Reference Des.	Value	Description	Manuf.	Part Number
U1	n/a	Bypass LNA	Qorvo	TQL9063
C2	27 pF	CAP, chip, 0402	Various	
C1, C3, C4	100 pF	CAP, 0402, +/-5%, 50V	Panasonic	ECJ-0EC1H101J
C6	1000 pF	CAP, 0402	various	
C5	1.0 uF	Cap., Chip, 0402, 10%, 10V, X5R	various	
C9	0.5 pF	Cap. Chip, 0402, +/-0.1pF, 50V	Murata	GJM1555C1HR50BB01D
R1, R2, R3	0 $\Omega$	RES, 0402, +/-5%, 1/10W	various	
L1	68 nH	IND, 0603, +/-5%	Coilcraft	0603CS-68NXJL
L2	1 nH	IND, chip, +/-0.1nH	Murata	LQP15MN1N0B



## Performance Plots- Optimized Return Loss

Test conditions unless otherwise noted:  $V_{DD} = +5\text{ V}$

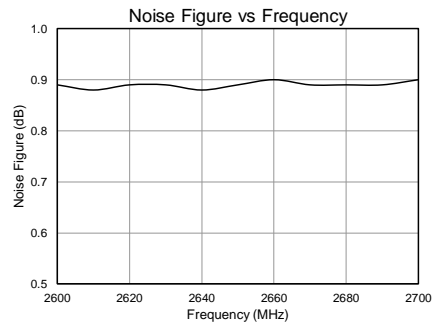
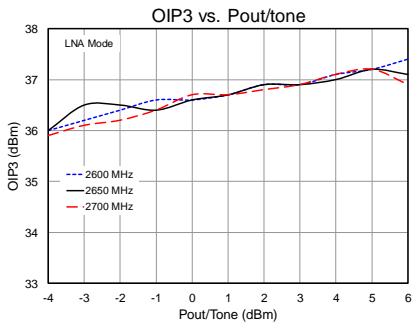
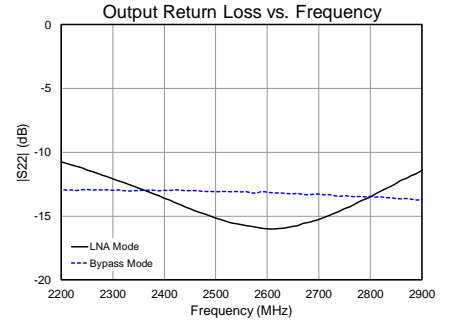
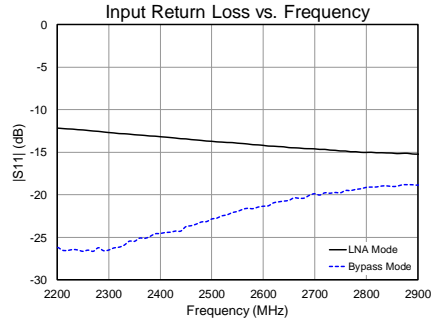
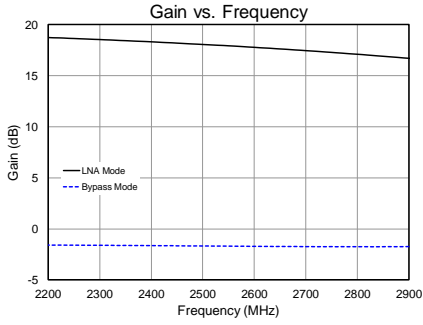

## Pin Configuration and Description

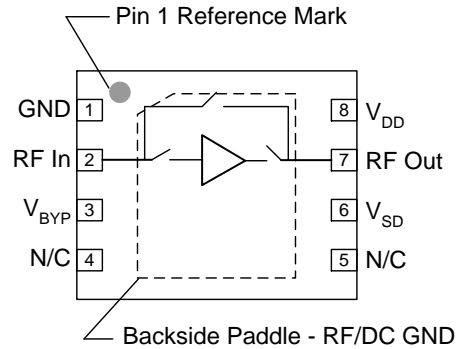

Pin No.	Label	Description
1	GND	RF/DC Ground pin.
2	RFin	RF input pin. DC block required.
3	V <sub>BYP</sub>	Control pin for bypass mode. The LNA is automatically turned off when the bypass mode is activated. Refer to truth table.
4, 5	N/C	No internal connection. Provide grounded PCB land pads for mounting integrity.
6	V <sub>SD</sub>	Control pin to disable the LNA. Refer to truth table.
7	RFout	RF output pin. DC block required.
8	V <sub>DD</sub>	Supply voltage pin.
Backside Paddle	RF/DC GND	RF/DC Ground. Follow recommended via pattern and ensure good solder attach for best thermal and electrical performance.

## Evaluation Board PCB Information

### Qorvo PCB 1121181 Material and Stack-up

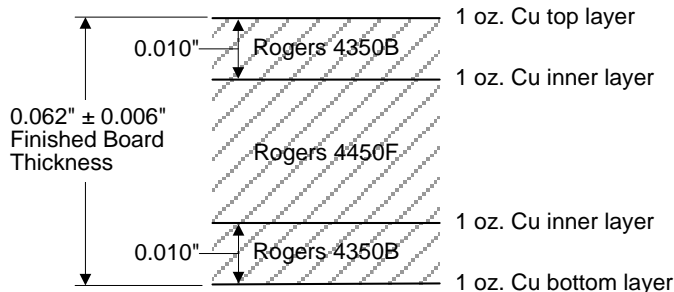

50 ohm line dimensions: width = .020", spacing = .032"

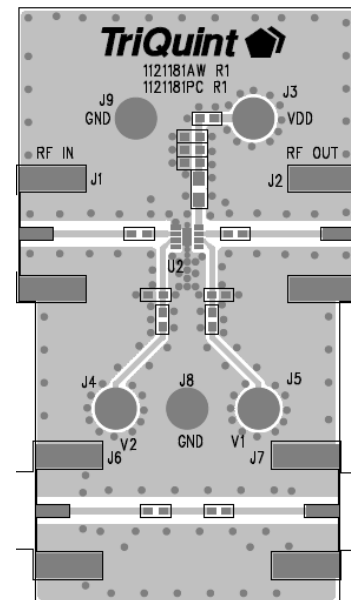

## Mechanical Information

### Package Marking and Dimensions

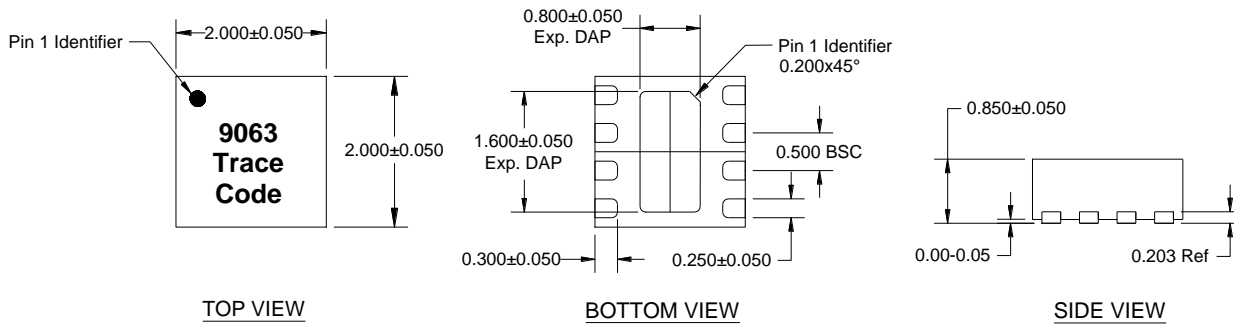

#### NOTES:

1. All dimensions are in millimeters. Angles are in degrees.
2. Except where noted, this part outline conforms to JEDEC standard MO-229.
3. Dimension and tolerance formats conform to ASME Y14.4M-1994.
4. The terminal #1 identifier and terminal numbering conform to JESD 95-1 SPP-012.

### PCB Mounting Pattern

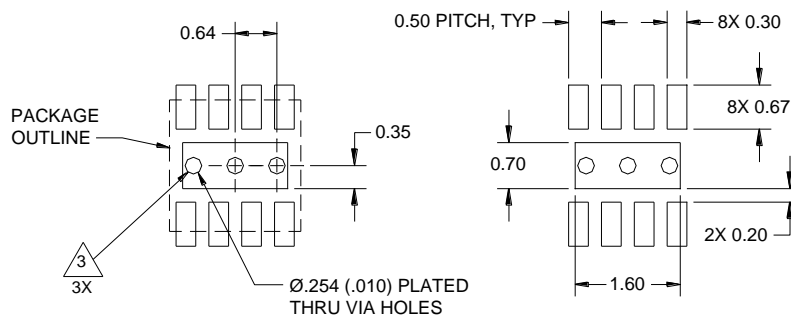

#### NOTES:

1. All dimensions are in millimeters. Angles are in degrees.
2. Use 1 oz. copper minimum for top and bottom layer metal.
3. Vias are required under the backside paddle of this device for proper RF/DC grounding and thermal dissipation. We recommend a  $0.35$  mm ( $\#80/.0135$ " ) diameter bit for drilling via holes and a final plated thru diameter of  $0.25$  mm ( $0.10$ " ).
4. Ensure good package backside paddle solder attach for reliable operation and best electrical performance.

## Handling Precautions

Parameter	Rating	Standard
ESD – Human Body Model (HBM)	1B	ESDA / JEDEC JS-001-2012
ESD – Charged Device Model (CDM)	C3	JEDEC JESD22-C101F
MSL – Moisture Sensitivity Level	Level 1	IPC/JEDEC J-STD-020



Caution!  
ESD-Sensitive Device

## Solderability

Compatible with both lead-free (260°C max. reflow temp.) and tin/lead (245°C max. reflow temp.) soldering processes. Solder profiles available upon request.

Contact plating: NiPdAu

## RoHS Compliance

This part is compliant with the 2011/65/EU RoHS directive (Restrictions on the Use of Certain Hazardous Substances in Electrical and Electronic Equipment) as amended by Directive 2015/863/EU. This product also has the following attributes:

- Product uses RoHS Exemption 7c-I to meet RoHS Compliance requirements.
- Halogen Free (Chlorine, Bromine)
- Antimony Free
- TBBP-A (C<sub>15</sub>H<sub>12</sub>Br<sub>4</sub>O<sub>2</sub>) Free
- PFOS Free
- SVHC Free

## Contact Information

For the latest specifications, additional product information, worldwide sales and distribution locations:

Web: [www.qorvo.com](http://www.qorvo.com)

Tel: 1-844-890-8163

Email: [customer.support@qorvo.com](mailto:customer.support@qorvo.com)

For technical questions and application information:

Email: [appsupport@qorvo.com](mailto:appsupport@qorvo.com)

## Important Notice

The information contained herein is believed to be reliable; however, Qorvo makes no warranties regarding the information contained herein and assumes no responsibility or liability whatsoever for the use of the information contained herein. All information contained herein is subject to change without notice. Customers should obtain and verify the latest relevant information before placing orders for Qorvo products. The information contained herein or any use of such information does not grant, explicitly or implicitly, to any party any patent rights, licenses, or any other intellectual property rights, whether with regard to such information itself or anything described by such information. **THIS INFORMATION DOES NOT CONSTITUTE A WARRANTY WITH RESPECT TO THE PRODUCTS DESCRIBED HEREIN, AND QORVO HEREBY DISCLAIMS ANY AND ALL WARRANTIES WITH RESPECT TO SUCH PRODUCTS WHETHER EXPRESS OR IMPLIED BY LAW, COURSE OF DEALING, COURSE OF PERFORMANCE, USAGE OF TRADE OR OTHERWISE, INCLUDING THE IMPLIED WARRANTIES OF MERCHANTABILITY AND FITNESS FOR A PARTICULAR PURPOSE.**

Without limiting the generality of the foregoing, Qorvo products are not warranted or authorized for use as critical components in medical, life-saving, or life-sustaining applications, or other applications where a failure would reasonably be expected to cause severe personal injury or death.

Copyright 2016 © Qorvo, Inc. | Qorvo is a registered trademark of Qorvo, Inc.

Компания «Life Electronics» занимается поставками электронных компонентов импортного и отечественного производства от производителей и со складов крупных дистрибьюторов Европы, Америки и Азии.

С конца 2013 года компания активно расширяет линейку поставок компонентов по направлению коаксиальный кабель, кварцевые генераторы и конденсаторы (керамические, пленочные, электролитические), за счёт заключения дистрибьюторских договоров

Мы предлагаем:

- Конкурентоспособные цены и скидки постоянным клиентам.
- Специальные условия для постоянных клиентов.
- Подбор аналогов.
- Поставку компонентов в любых объемах, удовлетворяющих вашим потребностям.
- Приемлемые сроки поставки, возможна ускоренная поставка.
- Доставку товара в любую точку России и стран СНГ.
- Комплексную поставку.
- Работу по проектам и поставку образцов.
- Формирование склада под заказчика.
- Сертификаты соответствия на поставляемую продукцию (по желанию клиента).
- Тестирование поставляемой продукции.
- Поставку компонентов, требующих военную и космическую приемку.
- Входной контроль качества.
- Наличие сертификата ISO.

В составе нашей компании организован Конструкторский отдел, призванный помогать разработчикам, и инженерам.

Конструкторский отдел помогает осуществить:

- Регистрацию проекта у производителя компонентов.
- Техническую поддержку проекта.
- Защиту от снятия компонента с производства.
- Оценку стоимости проекта по компонентам.
- Изготовление тестовой платы монтаж и пусконаладочные работы.



Тел: +7 (812) 336 43 04 (многоканальный)

Email: [org@lifeelectronics.ru](mailto:org@lifeelectronics.ru)