

Tall Stacker Connector: BTB

00-9148



AVX extends their range of board-to-board stacker connectors used to connect two PCB's, with a new tall version 00-9148. This new connector is designed to connect 2 parallel boards using a 1-piece connector design for board spacing of 8mm in a double row configuration offering 8 positions at 1mm pitch. With a rated current of 1A continuous through each contact.

Flexible tooling means that versions for board spacing between 4-12mm can be accommodated, with single row (4-16 positions) or double row (8-32 positions) options all on the same 1mm contact pitch. Options can also include bosses for mechanical stability, if required.

The connector is designed for surface mounting and supplied in tape and reel packaging. It mates with gold plated pads on the mating board surface. The tall stacker connector 00-9148 is suitable for wide range of applications including harsh environments such as those encountered in the automotive industry. It is a cost effective, reliable and robust BTB solution proven over time with 50 mating operations, high temperature nylon plastic and gold plated beryllium copper contacts for RoHS soldering.

This connector can be also customized to suit your application, with various number of rows / positions or stacking heights.

APPLICATIONS

- Automotive applications such as entertainment systems
- Handheld/portable devices requiring docking or cradle charging
- Patient monitoring or portable medical electronics
- Industrial devices requiring pluggable or programming modules
- Internet appliances requiring battery back-up

FEATURES AND BENEFITS

- Reduced assembly time
- Only one part to purchase and stock
- Extremely robust when subjected to shock and vibration
- Helps reduce tolerance accumulation within system
- Many options for customized versions

ELECTRICAL

- Current Rating: 1 Amp continuous through all contacts
- Voltage Rating: 125 VAC

ENVIRONMENTAL

- Operating Temperature: -40°C to +125°C

MECHANICAL

- Insulator Material: High Temperature Plastic to UL94V0
- Contact Material: Beryllium Copper
- Plating: Gold on Nose, Pure Tin SMT terminations over base Nickel
- Durability: 50 Cycles

HOW TO ORDER

00
Prefix
Board to
Board
Connector

9148
Series

008
Number
of Ways
008 = 8

080
Stacking Height
080 = 8mm

2
Number of Rows
2 = Double Row

X
With or Without
Boss
0 = Without Boss

X
With or Without Boss
Plating Option
6 = 0.25µm Gold on Nose, Standard
8 = 0.80µm Gold on Nose,
Special order only



Tall Stacker Connector: BTB

00-9148

8-WAY – 8MM STACKING HEIGHT

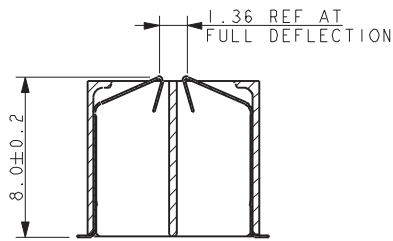
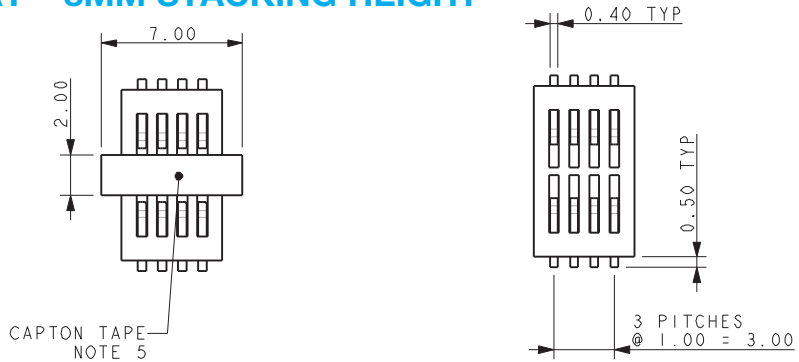
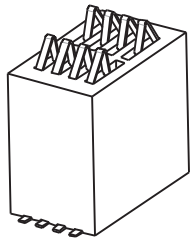

SECTION ON A-A FULL DEFLECTION

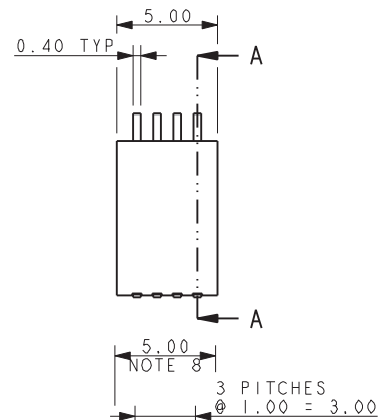
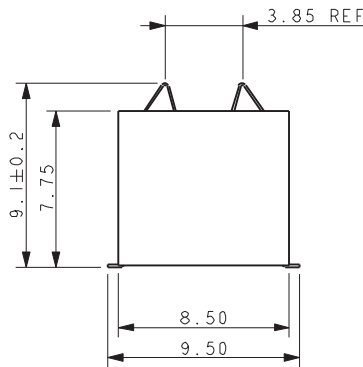

PACKING DETAILS

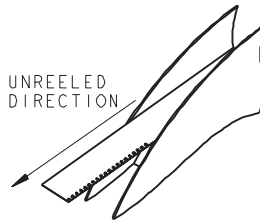
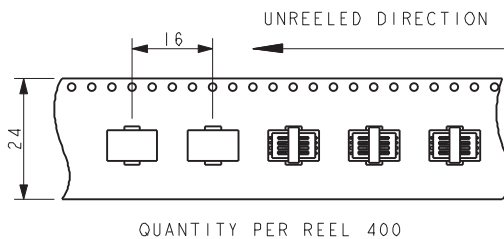

330mm DIAMETER REEL

SMT PCB FOOTPRINT

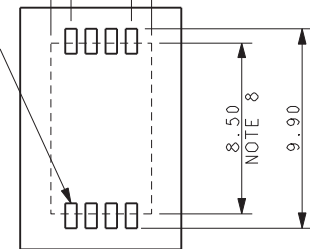

8 PADS 0.6 x 1.25

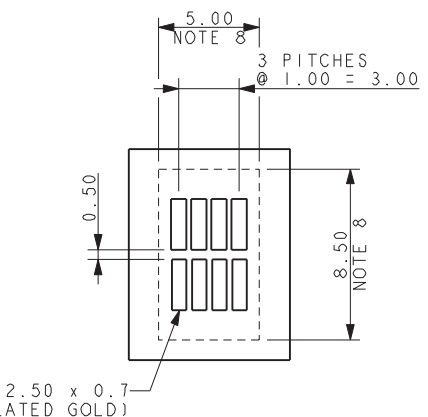

MATING PCB LAYOUT

NOTES:

- SALES DRAWING FOR 8 WAY DOUBLE ROW STACKER AVX SERIES 9148.
- FOR PRODUCT SPECIFICATION REFER TO ELCO SPEC 201-01-173.
- MATERIALS:
INSULATOR: NYLON 46, CLASS FILLED, UL94 V0. COLOR BLACK
CONTACT: BERYLLIUM COPPER STRIP 0.1mm THICK
PLATING: 1.00µm MAX NICKEL ALL OVER, 2.00-4.00 µm PURE TIN TAIL 0.25 µm
GOLD NOSE STANDARD (REFER TO PAGE 1).
- PART TO BE PACKED IN TAPE AND REEL. QTY PER REEL: 400.
- SUPPLIED WITH CATON TAPE TO AID PICK AND PLACE, TO BE REMOVED AFTER RE-FLOW OPERATION.
- GENERAL TOLERANCE ± 0.20 (UNLESS OTHERWISE STATED).
- PCB STACKED HEIGHT 8.00 ± 0.20 .
- CONNECTOR OUTLINE.

Компания «Life Electronics» занимается поставками электронных компонентов импортного и отечественного производства от производителей и со складов крупных дистрибьюторов Европы, Америки и Азии.

С конца 2013 года компания активно расширяет линейку поставок компонентов по направлению коаксиальный кабель, кварцевые генераторы и конденсаторы (керамические, пленочные, электролитические), за счёт заключения дистрибьюторских договоров

Мы предлагаем:

- Конкурентоспособные цены и скидки постоянным клиентам.
- Специальные условия для постоянных клиентов.
- Подбор аналогов.
- Поставку компонентов в любых объемах, удовлетворяющих вашим потребностям.
- Приемлемые сроки поставки, возможна ускоренная поставка.
- Доставку товара в любую точку России и стран СНГ.
- Комплексную поставку.
- Работу по проектам и поставку образцов.
- Формирование склада под заказчика.
- Сертификаты соответствия на поставляемую продукцию (по желанию клиента).
- Тестирование поставляемой продукции.
- Поставку компонентов, требующих военную и космическую приемку.
- Входной контроль качества.
- Наличие сертификата ISO.

В составе нашей компании организован Конструкторский отдел, призванный помогать разработчикам, и инженерам.

Конструкторский отдел помогает осуществить:

- Регистрацию проекта у производителя компонентов.
- Техническую поддержку проекта.
- Защиту от снятия компонента с производства.
- Оценку стоимости проекта по компонентам.
- Изготовление тестовой платы монтаж и пусконаладочные работы.



Тел: +7 (812) 336 43 04 (многоканальный)

Email: org@lifeelectronics.ru