

# BSP75N

## 60V self-protected low-side Intellifet™ MOSFET switch

### Summary

Continuous drain source voltage	$V_{DS}=60V$
On-state resistance	500mΩ
Maximum nominal load current <sup>(a)</sup>	1.1A ( $V_{IN} = 5V$ )
Minimum nominal load current <sup>(c)</sup>	0.7A ( $V_{IN} = 5V$ )
Clamping energy	550mJ

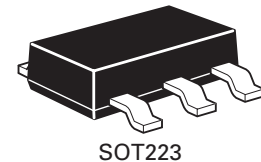

### Description

Self-protected low side MOSFET. Monolithic over temperature, over current, over voltage (active clamp) and ESD protected logic level functionality. Intended as a general purpose switch.

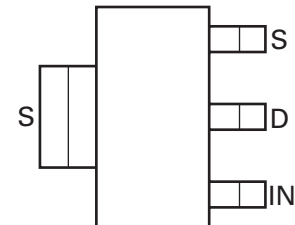

### Features

- Short circuit protection with auto restart
- Over-voltage protection (active clamp)
- Thermal shutdown with auto restart
- Over-current protection
- Input protection (ESD)
- High continuous current rating
- Load dump protection (actively protects load)
- Logic level input

### Note:

The tab is connected to the source pin and must be electrically isolated from the drain pin. Connection of significant copper to the drain pin is recommended for best thermal performance.

### Ordering information

Device	Reel size (inches)	Tape width (mm)	Quantity per reel
BSP75NTA	7	12mm embossed	1000

### Device marking

BSP75N

## Functional block diagram

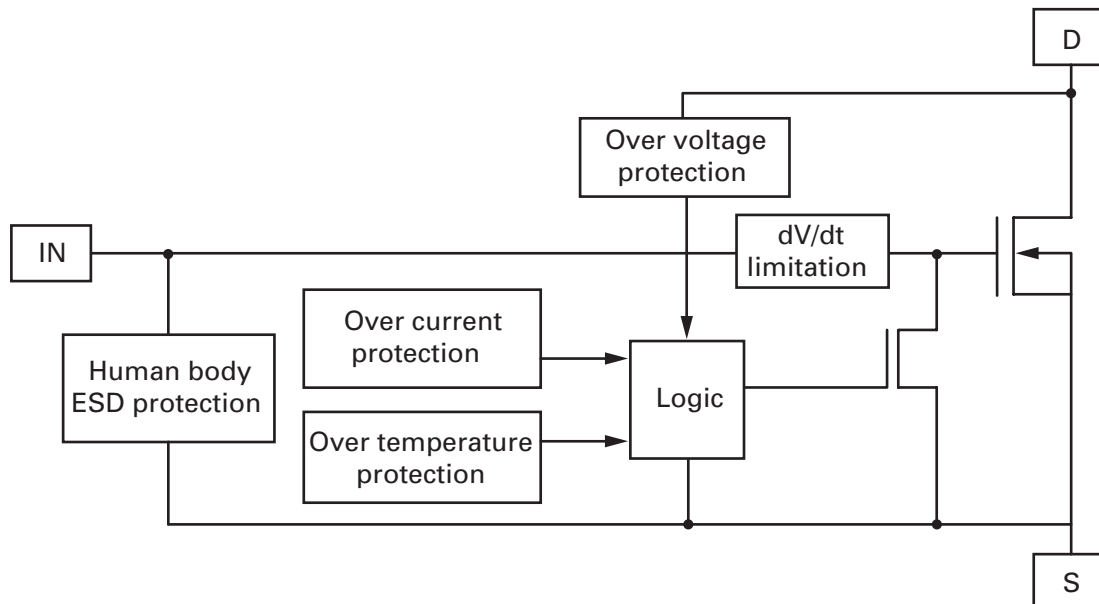

## Applications

- Especially suited for loads with a high in-rush current such as lamps and motors.
- All types of resistive, inductive and capacitive loads in switching applications.
- $\mu\text{C}$  compatible power switch for 12V and 24V DC applications.
- Automotive rated.
- Replaces electromechanical relays and discrete circuits.

Linear mode capability - the current-limiting protection circuitry is designed to de-activate at low  $V_{\text{ds}}$ , in order not to compromise the load current during normal operation. The design maximum DC operating current is therefore determined by the thermal capability of the package/board combination, rather than by the protection circuitry. This does not compromise the products ability to self protect itself at low  $V_{\text{DS}}$ .

## Absolute maximum ratings

Parameter	Symbol	Limit	Unit
Continuous drain-source voltage	$V_{DS}$	60	V
Drain-source voltage for short circuit protection $V_{IN} = 5V$	$V_{DS(SC)}$	36	V
Drain-source voltage for short circuit protection $V_{IN} = 10V$	$V_{DS(SC)}$	20	V
Continuous input voltage	$V_{IN}$	-0.2 ... +10	V
Peak input voltage	$V_{IN}$	-0.2 ... +20	V
Operating temperature range	$T_j$	-40 to +150	°C
Storage temperature range	$T_{stg}$	-55 to +150	°C
Power dissipation at $T_A = 25^\circ\text{C}$ <sup>(a)</sup>	$P_D$	1.5	W
Power dissipation at $T_A = 25^\circ\text{C}$ <sup>(c)</sup>	$P_D$	0.6	W
Continuous drain current @ $V_{IN}=10V$ ; $T_A=25^\circ\text{C}$ <sup>(a)</sup>	$I_D$	1.3	A
Continuous drain current @ $V_{IN}=5V$ ; $T_A=25^\circ\text{C}$ <sup>(a)</sup>	$I_D$	1.1	A
Continuous drain current @ $V_{IN}=5V$ ; $T_A=25^\circ\text{C}$ <sup>(c)</sup>	$I_D$	0.7	A
Continuous source current (body diode) <sup>(a)</sup>	$I_S$	2.0	A
Pulsed source current (body diode) <sup>(b)</sup>	$I_S$	3.3	A
Unclamped single pulse inductive energy	$E_{AS}$	550	mJ
Load dump protection	$V_{LoadDump}$	80	V
Electrostatic discharge (human body model)	$V_{ESD}$	4000	V
DIN humidity category, DIN 40 040		E	
IEC climatic category, DIN IEC 68-1		40/150/56	

## Thermal resistance

Parameter	Symbol	Limit	Unit
Junction to ambient <sup>(a)</sup>	$R_{\theta JA}$	83	°C/W
Junction to ambient <sup>(b)</sup>	$R_{\theta JA}$	45	°C/W
Junction to ambient <sup>(c)</sup>	$R_{\theta JA}$	208	°C/W

### NOTES:

(a) For a device surface mounted on 25mm x 25mm x 1.6mm FR4 board with a high coverage of single sided 2oz weight copper. Allocation of 6cm<sup>2</sup> copper 33% to source tab and 66% to drain pin with tab and drain pin electrically isolated.

(b) For a device surface mounted on FR4 board as (a) and measured at  $t \leq 10s$ .

(c) For a device surface mounted on FR4 board with the minimum copper required for connections.

## Electrical characteristics (at $T_{AMB} = 25^{\circ}\text{C}$ unless otherwise stated)

Parameter	Symbol	Min.	Typ.	Max.	Unit	Conditions
<b>Static characteristics</b>						
Drain-source clamp voltage	$V_{DS(AZ)}$	60	70	75	V	$I_D=10\text{mA}$
Off-state drain current	$I_{DSS}$		0.1	3	$\mu\text{A}$	$V_{DS}=12\text{V}, V_{IN}=0\text{V}$
Off-state drain current	$I_{DSS}$		3	15	$\mu\text{A}$	$V_{DS}=32\text{V}, V_{IN}=0\text{V}$
Input threshold voltage (*)	$V_{IN(th)}$	1	2.1		V	$V_{DS}=V_{GS}, I_D=1\text{mA}$
Input current	$I_{IN}$		0.7	1.2	mA	$V_{IN}=+5\text{V}$
Input current	$I_{IN}$		1.5	2.7	mA	$V_{IN}=+7\text{V}$
Input current	$I_{IN}$		4	7	mA	$V_{IN}=+10\text{V}$
Static drain-source on-state resistance	$R_{DS(on)}$		520	675	$\text{m}\Omega$	$V_{IN}=+5\text{V}, I_D=0.7\text{A}$
Static drain-source on-state resistance	$R_{DS(on)}$		385	550	$\text{m}\Omega$	$V_{IN}=+10\text{V}, I_D=0.7\text{A}$
Current limit (†)	$I_{D(LIM)}$	0.7	1.0	1.5	A	$V_{IN}=+5\text{V}, V_{DS}>5\text{V}$
Current limit (†)	$I_{D(LIM)}$	1.0	1.8	2.3	A	$V_{IN}=+10\text{V}, V_{DS}>5\text{V}$
<b>Dynamic characteristics</b>						
Turn-on time ( $V_{IN}$ to 90% $I_D$ )	$t_{on}$		3.0	10	$\mu\text{s}$	$R_L=22\Omega, V_{DD}=12\text{V}, V_{IN}=0$ to $+10\text{V}$
Turn-off time ( $V_{IN}$ to 90% $I_D$ )	$t_{off}$		13	20	$\mu\text{s}$	$R_L=22\Omega, V_{DD}=12\text{V}, V_{IN}=+10\text{V}$ to $0\text{V}$
Slew rate on (70 to 50% $V_{DD}$ )	$-dV_{DS}/dt_{on}$		8	20	$\text{V}/\mu\text{s}$	$R_L=22\Omega, V_{DD}=12\text{V}, V_{IN}=0$ to $+10\text{V}$
Slew rate off (50 to 70% $V_{DD}$ )	$dV_{DS}/dt_{off}$		3.2	10	$\text{V}/\mu\text{s}$	$R_L=22\Omega, V_{DD}=12\text{V}, V_{IN}=+10\text{V}$ to $0\text{V}$
<b>Protection functions (‡)</b>						
Required input voltage for over temperature protection	$V_{PROT}$	4.5			V	
Thermal overload trip temperature	$T_{JT}$	150	175		$^{\circ}\text{C}$	
Thermal hysteresis			1		$^{\circ}\text{C}$	
Unclamped single pulse inductive energy $T_j=25^{\circ}\text{C}$	$E_{AS}$	550			mJ	$I_{D(ISO)}=0.7\text{A}, V_{DD}=32\text{V}$
Unclamped single pulse inductive energy $T_j=150^{\circ}\text{C}$		200			mJ	$I_{D(ISO)}=0.7\text{A}, V_{DD}=32\text{V}$
<b>Inverse diode</b>						
Source drain voltage	$V_{SD}$			1	V	$V_{IN}=0\text{V}, -I_D=1.4\text{A}$

### NOTES:

(\*) The drain current is limited to a reduced value when  $V_{DS}$  exceeds a safe level.

(†) Protection features may operate outside spec for  $V_{IN}<4.5\text{V}$ .

(‡) Integrated protection functions are designed to prevent IC destruction under fault conditions described in the datasheet. Fault conditions are considered as "outside" normal operating range. Protection functions are not designed for continuous, repetitive operation.

## Application information

The current-limit protection circuitry is designed to de-activate at low  $V_{DS}$  to prevent the load current from being unnecessarily restricted during normal operation. The design max DC operating current is therefore determined by the thermal capability of the package/board combination, rather than by the protection circuitry (see graph on page 7 'Typical Output Characteristic'). This does not compromise the products ability to self protect at low  $V_{DS}$ .

The overtemperature protection circuit trips at a minimum of 150°C. So the available package dissipation reduces as the maximum required ambient temperature increases. This leads to the following maximum recommended continuous operating currents.

## Minimum copper area characteristics

For minimum copper condition as described in note (c)

Max. ambient temperature $T_{amb}$	Maximum continuous current	
	$V_{IN} = 5V$	$V_{IN} = 10V$
25°C @ $V_{IN} = 5V$	720	840
70°C @ $V_{IN} = 5V$	575	670
85°C @ $V_{IN} = 5V$	520	605
125°C @ $V_{IN} = 5V$	320	375

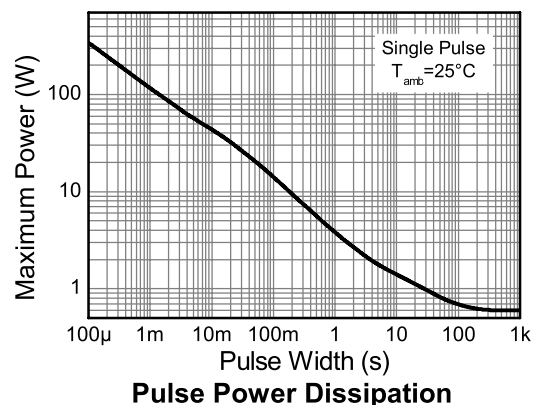
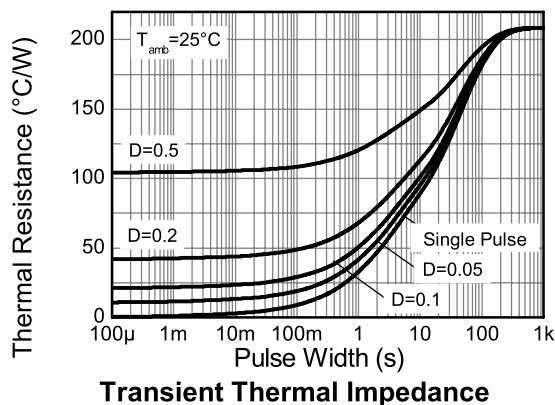
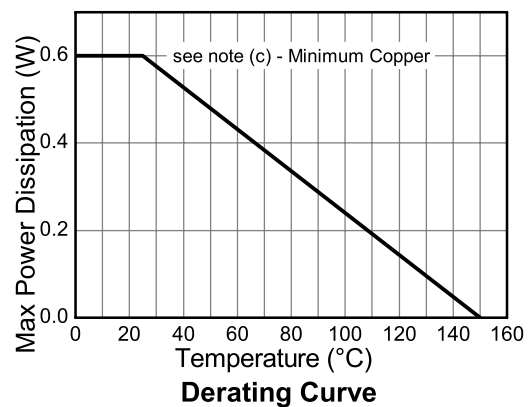
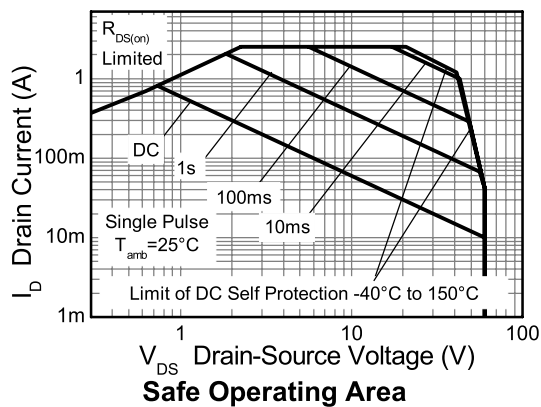

## Large copper area characteristics

For large copper area as described in note (a)

Max. ambient temperature $T_{amb}$	Maximum continuous current	
	$V_{IN} = 5V$	$V_{IN} = 10V$
25°C @ $V_{IN} = 5V$	1140	1325
70°C @ $V_{IN} = 5V$	915	1060
85°C @ $V_{IN} = 5V$	825	955
125°C @ $V_{IN} = 5V$	510	590

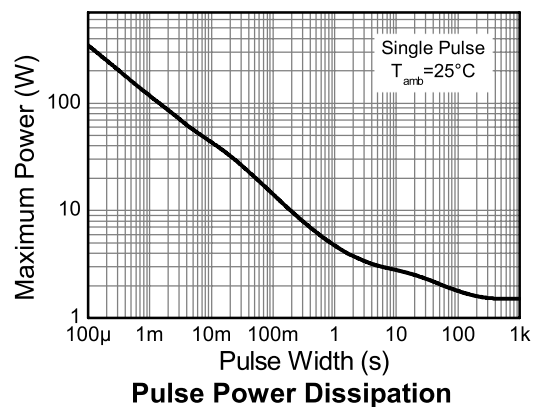
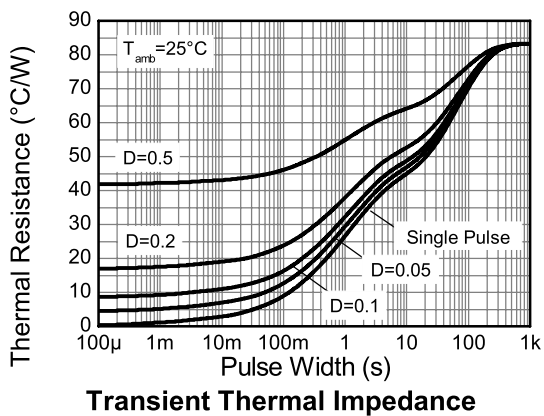
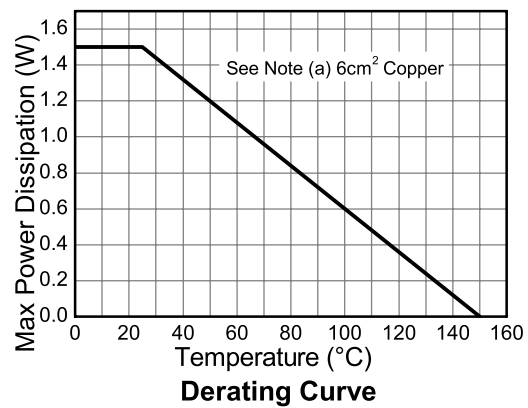
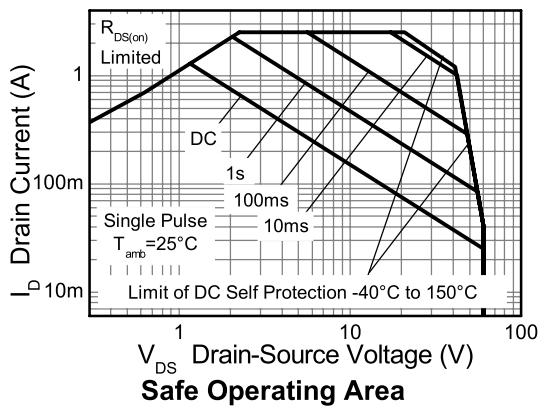

## Typical characteristics

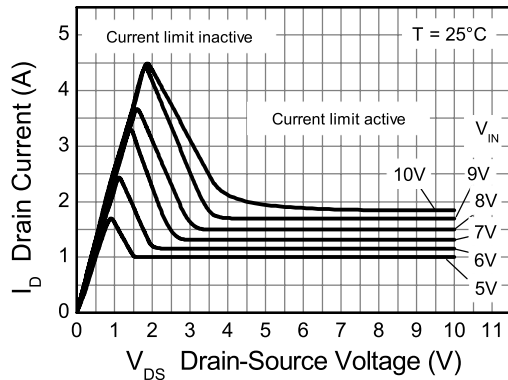

**Typical Output Characteristic**

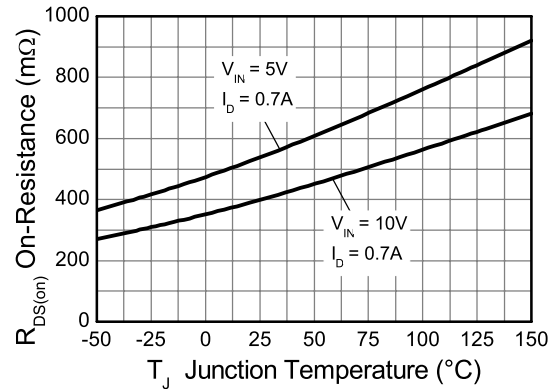

**On-state Resistance vs Temperature**

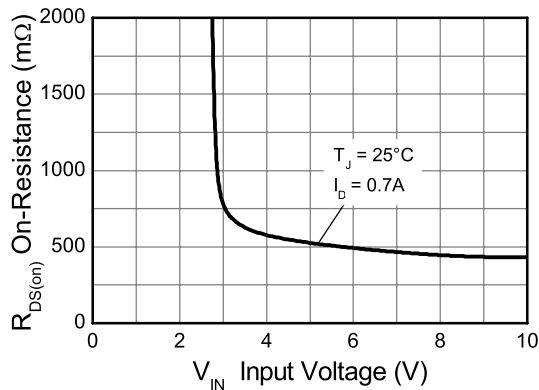

**On-Resistance vs Input Voltage**

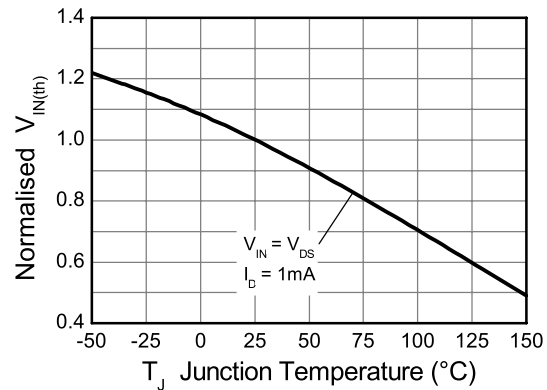

**Threshold Voltage vs Temperature**

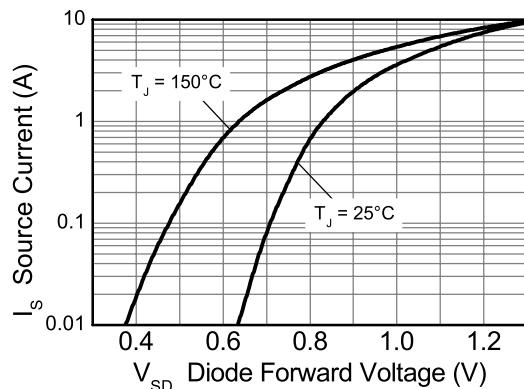

**Source-Drain Diode Forward Voltage**

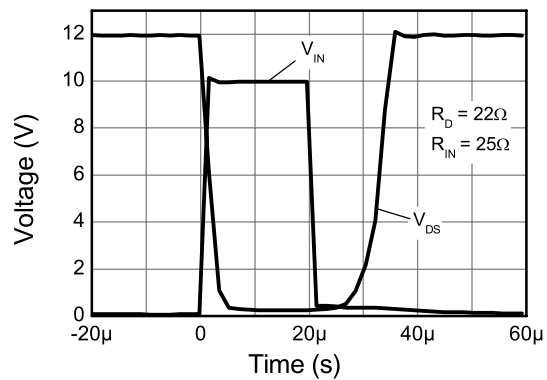

**Switching Speed**

## Package outline - SOT223

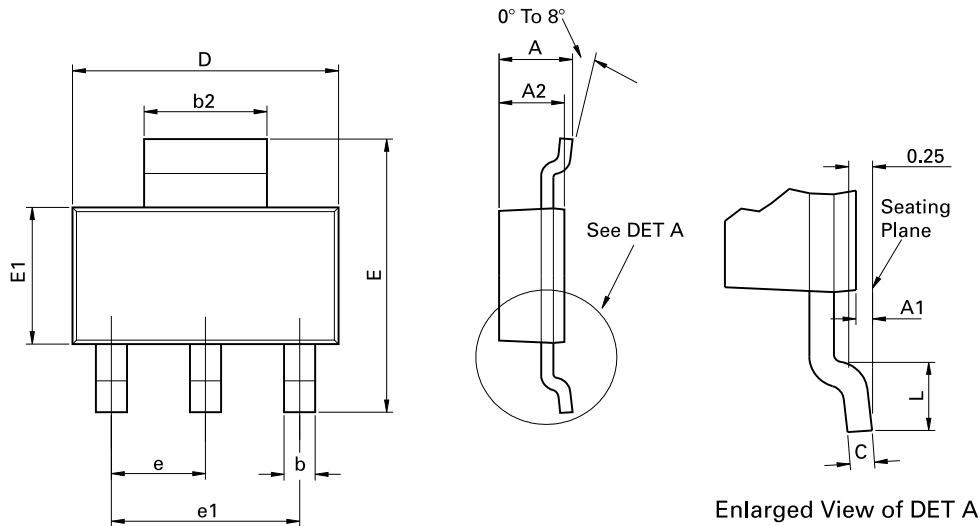

Conforms to JEDEC TO-261 AA Issue B

Dim.	Millimeters		Inches		Dim.	Millimeters		Inches	
	Min.	Max.	Min.	Max.		Min.	Max.	Min.	Max.
A	-	1.80	-	0.071	e	2.30 BSC		0.0905 BSC	
A1	0.02	0.10	0.0008	0.004	e1	4.60 BSC		0.181 BSC	
b	0.66	0.84	0.026	0.033	E	6.70	7.30	0.264	0.287
b2	2.90	3.10	0.114	0.122	E1	3.30	3.70	0.130	0.146
C	0.23	0.33	0.009	0.013	L	0.90	-	0.355	-
D	6.30	6.70	0.248	0.264	-	-	-	-	-

**Note:** Controlling dimensions are in millimeters. Approximate dimensions are provided in inches

Europe	Americas	Asia Pacific	Corporate Headquarters
Zetex GmbH Kustermann-park Balanstraße 59 D-81541 München Germany Telephone: (49) 89 45 49 49 0 Fax: (49) 89 45 49 49 49 europe.sales@zetex.com	Zetex Inc 700 Veterans Memorial Highway Hauppauge, NY 11788 USA Telephone: (1) 631 360 2222 Fax: (1) 631 360 8222 usa.sales@zetex.com	Zetex (Asia Ltd) 3701-04 Metroplaza Tower 1 Hing Fong Road, Kwai Fong Hong Kong Telephone: (852) 26100 611 Fax: (852) 24250 494 asia.sales@zetex.com	Zetex Semiconductors plc Zetex Technology Park, Chadderton Oldham, OL9 9LL United Kingdom Telephone: (44) 161 622 4444 Fax: (44) 161 622 4446 hq@zetex.com

For international sales offices visit [www.zetex.com/offices](http://www.zetex.com/offices)

Zetex products are distributed worldwide. For details, see [www.zetex.com/salesnetwork](http://www.zetex.com/salesnetwork)

This publication is issued to provide outline information only which (unless agreed by the company in writing) may not be used, applied or reproduced for any purpose or form part of any order or contact or be regarded as a representation relating to the products or services concerned. The company reserves the right to alter without notice the specification, design, price or conditions of supply of any product or service.



Компания «Life Electronics» занимается поставками электронных компонентов импортного и отечественного производства от производителей и со складов крупных дистрибьюторов Европы, Америки и Азии.

С конца 2013 года компания активно расширяет линейку поставок компонентов по направлению коаксиальный кабель, кварцевые генераторы и конденсаторы (керамические, пленочные, электролитические), за счёт заключения дистрибьюторских договоров

Мы предлагаем:

- Конкурентоспособные цены и скидки постоянным клиентам.
- Специальные условия для постоянных клиентов.
- Подбор аналогов.
- Поставку компонентов в любых объемах, удовлетворяющих вашим потребностям.
- Приемлемые сроки поставки, возможна ускоренная поставка.
- Доставку товара в любую точку России и стран СНГ.
- Комплексную поставку.
- Работу по проектам и поставку образцов.
- Формирование склада под заказчика.
- Сертификаты соответствия на поставляемую продукцию (по желанию клиента).
- Тестирование поставляемой продукции.
- Поставку компонентов, требующих военную и космическую приемку.
- Входной контроль качества.
- Наличие сертификата ISO.

В составе нашей компании организован Конструкторский отдел, призванный помогать разработчикам, и инженерам.

Конструкторский отдел помогает осуществить:

- Регистрацию проекта у производителя компонентов.
- Техническую поддержку проекта.
- Защиту от снятия компонента с производства.
- Оценку стоимости проекта по компонентам.
- Изготовление тестовой платы монтаж и пусконаладочные работы.



Тел: +7 (812) 336 43 04 (многоканальный)

Email: [org@lifeelectronics.ru](mailto:org@lifeelectronics.ru)