

18000 series

Snap-action momentary pushbutton switches



DISTINCTIVE FEATURES

Panel and PC mount models
Snap-in panel mounting version
Tactile feedback



ELECTRICAL SPECIFICATIONS

- Max. current/voltage rating with resistive load :
 - gold plated brass contacts : 100 mA - 30 VDC
 - gold plated silver contacts : 1 A 30 VDC
- Initial contact resistance : 50 mΩ max.
- Insulation resistance : 1,000 MΩ min.
- Dielectric strength : 1,000 Vrms 50 Hz min.
- Electrical life : 60,000 cycles at full load



GENERAL SPECIFICATIONS

- Total travel : 0.5 mm (.019)
- Torque : 1.25 Nm (.922 Ft.lb) max. applied to nut
- Operating temperature : -30 °C to +65 °C (-22 °F to +149 °F)
- Soldering : 300 °C (572 °F), 3 sec. max.



MATERIALS

- Case : PBT
- Actuator : polyamide, glass filled
- Bushing : brass, nickel plated
- Housing : stainless steel
- Bracket : tin plated steel
- Contacts
 - AD : silver, gold plated
 - CD : brass, gold plated
- Terminal seal : epoxy

APEM products may be recycled at end-of-life for the re-claiming of valuable metal components.

The company reserves the right to change specifications without notice.



18000 series

Snap-action momentary pushbutton switches

TERMINALS

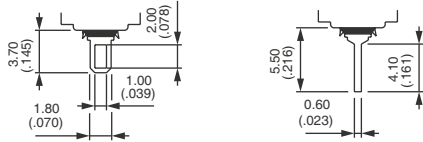

ELECTRICAL FUNCTION

→ KEYWAY

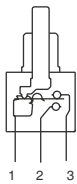

Plain bushing

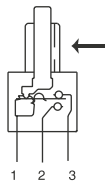

Threaded bushing

PANEL CUT-OUT

18500 - 18200

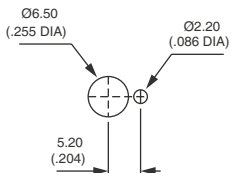

18700 - 18900

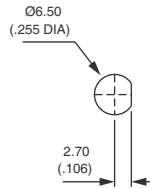

18800

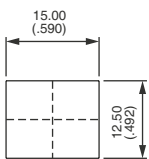

With bezel U1200

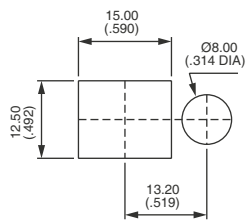

With bezel U1210 for LED

18000 series

Snap-action momentary pushbutton switches



BUILD YOUR PART NUMBER



ABOUT THIS SERIES

On the following pages, you will find successively basic part numbers of switches and options in the same order as in above chart.

- ⚠ **Notice** : please note that not all combinations of above numbers are available. Refer to following pages for further information.
- 🔒 **Sealing boots** are available to protect the switches against dust and water. See "Sealing Boots" section on website.
- 🔧 **Mounting accessories** : standard hardware supplied with all models with Ø 6,35 (1/4) threaded bushing : 2 hex nuts 8 mm (.314) across flats, 1 locking ring and 1 lockwasher. Standard and special hardware is presented in the "Hardware" section of website.

18000 series

Snap-action momentary pushbutton switches

THREADED BUSHING SOLDER LUG TERMINALS : 18500



Single pole	1-3	1-2
18535	ON	MOM
Double pole	1-3	1-2
18545	ON	MOM



→ KEYWAY

Shown with standard plunger

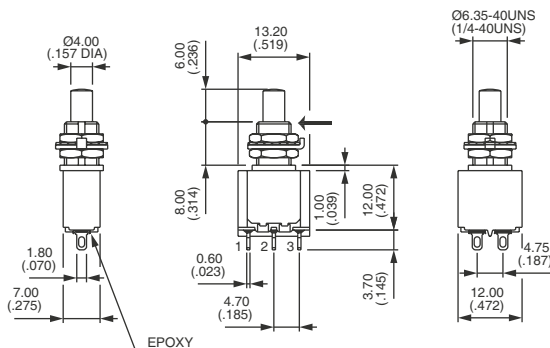

FLATTED BUSHING SOLDER LUG TERMINALS : 18700



Single pole	1-3	1-2
18735	ON	MOM
Double pole	1-3	1-2
18745	ON	MOM



→ KEYWAY

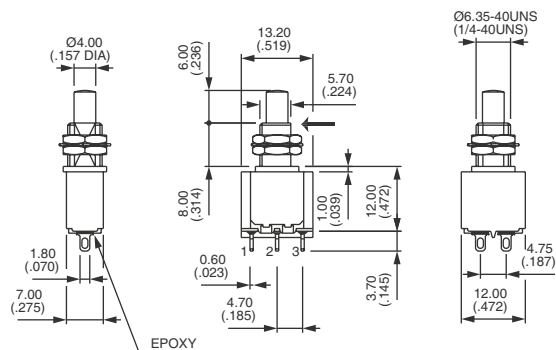

THREADED BUSHING STRAIGHT PC TERMINALS : 18200



Single pole	1-3	1-2
18235	ON	MOM
Double pole	1-3	1-2
18245	ON	MOM



→ KEYWAY

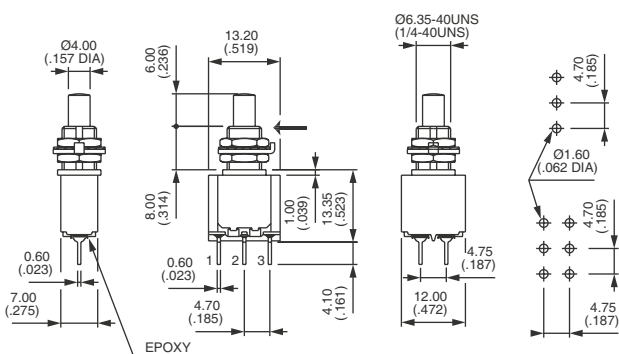

FLATTED BUSHING - STRAIGHT PC TERMINALS : 18900



Single pole	1-3	1-2
18935	ON	MOM
Double pole	1-3	1-2
18945	ON	MOM



→ KEYWAY

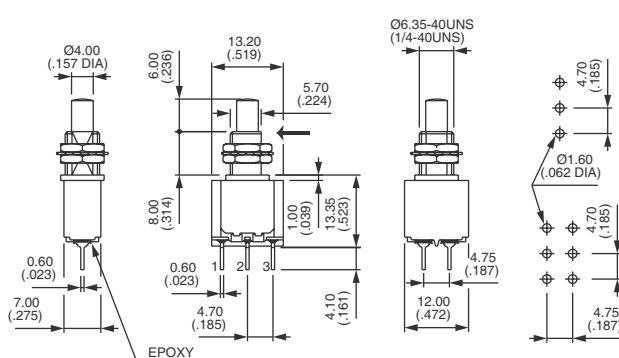

18000 series

Snap-action momentary pushbutton switches

SNAP-IN MOUNTING SOLDER LUG TERMINALS : 18800



Single pole

18835



1-3

ON



1-2

MOM

Double pole

18845

ON

MOM

Available with straight PC terminals : see X662 under "Special options"

STRAIGHT PC TERMINALS BRACKET MOUNTING - SINGLE POLE : 18230Y



18235Y



ON



MOM

STRAIGHT PC TERMINALS BRACKET MOUNTING - DOUBLE POLE : 18240Y



18245Y



ON



MOM

RIGHT ANGLE TERMINALS HORIZONTAL : 18200W



Single pole

18235W



ON



MOM

Double pole

18245W

ON

MOM

Shown with cap U910 + U1200



18000 series

Snap-action momentary pushbutton switches

PLAIN BUSHING - RIGHT ANGLE TERMINALS VERTICAL : 18200WW



Single pole

18235WW

Double pole

18245WW



1-3
ON



1-2
MOM

ON

MOM



CONTACT MATERIALS



- AD Silver, gold plated
- CD Brass, gold plated

PLUNGERS



Dash compulsory before plunger code.

- Blank Ø 4 (.157) - long
- 6 Ø 3.1 (.122)
- 3 Ø 4 (.157) - short
- 5 Ø 3.1 (.122)

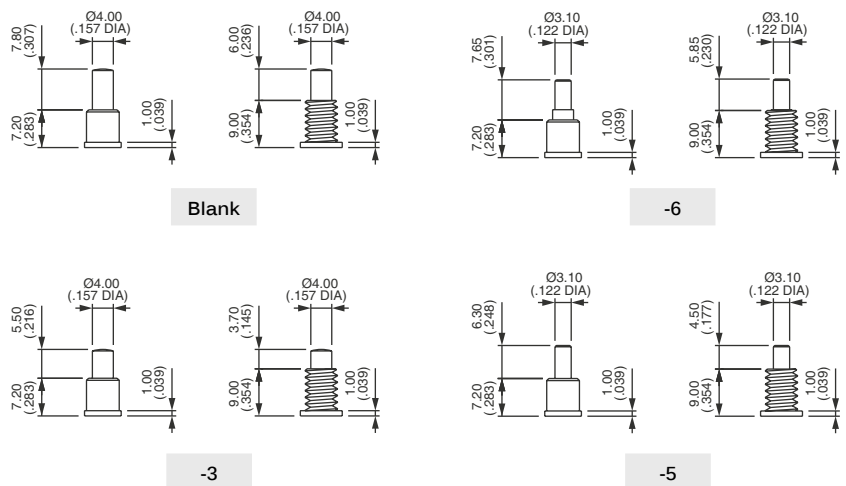

SPECIAL OPTIONS



- X371 Plain bushing Ø 6.25 mm (.246) (instead of standard threaded bushing).
- X372 Shorter threaded bushing Ø 6.35 (1/4). Height 7 mm (.274).

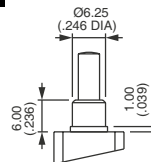

X371

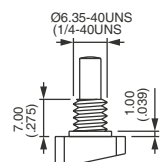

X372

18000 series

Snap-action momentary pushbutton switches

SPECIAL OPTIONS (CONTINUED)



- X386** Threaded bushing \varnothing 6.35 mm (1/4) to replace plain bushing on models W - WW and Y.
- X438** Plain bushing \varnothing 6.25 mm (.246). **Height 7,2 mm (.283) - without shoulder.**
- X624** Straight PC terminals - bracket mounting - with shorter bushing and plunger
- X662** Snap-in mounting - straight PC terminals



OPTION X624 - SINGLE POLE



18235Y -2X624



ON



MOM



OPTION X624 - DOUBLE POLE



18245Y -2X624



ON



MOM



OPTION X662



18000 series

Snap-action momentary pushbutton switches

CAPS



For cap colors, replace last "0" by number :

- | | | | |
|-----|-----------|-----|--------|
| 1 | Blue | 5 | Yellow |
| 1/4 | Dark blue | 6 | Red |
| 2 | Black | 7 | Ivory |
| 3 | Green | 7/1 | White |
| 4 | Grey | 9 | Orange |

CAPS FOR Ø 4 (.157) PLUNGERS (-13, -3)



CAPS FOR Ø 3.1 (.122) PLUNGERS (-5, -6)



CAPS FOR Ø 3.1 (.122) PLUNGERS (-5, -6)



18000 series

Snap-action momentary pushbutton switches

BEZELS



For cap colors, replace last "0" by number :

- | | | | |
|-----|-----------|-----|--------|
| 1 | Blue | 5 | Yellow |
| 1/4 | Dark blue | 6 | Red |
| 2 | Black | 7 | Ivory |
| 3 | Green | 7/1 | White |
| 4 | Grey | 9 | Orange |

STANDARD PANEL MOUNTING

Panel thickness with bezel : 1 mm (.039) to 2.5 mm (.098)



18800 + U910 + U1200



18800 + U910 + U1210

FOR BRACKET MOUNTING MODELS (18200Y & 18200YX624)



U3200

FOR SNAP-IN MODELS (18800 - 18800X662)



U1200



U1210
For LED Ø 5 - not supplied

DRESS NUTS

Order separately. For models with threaded bushing (18500 - 18700 - 18200 - 18900)
Chrome plated.

- U1636 For caps U1140 and U2510
- U840 For cap U480 and U2900
- U825 For caps U630 and U3400



U1636



U840

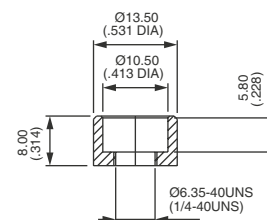

U825

18000 series

Snap-action momentary pushbutton switches •
high currents



DISTINCTIVE FEATURES

Tactile feedback
High currents



ELECTRICAL SPECIFICATIONS

- Max. current/voltage rating with resistive load : 7 A 30 VDC
- Initial contact resistance : 20 mΩ max. at 0.1 A 3 VDC
- Insulation resistance : 200,000 MΩ min. between terminals and frame
- Dielectric strength : 1,500 Vrms 50 Hz min.
- Electrical life : 60,000 cycles at full load



GENERAL SPECIFICATIONS

- Total travel : 0.9 mm (.035) approx.
- Operating temperature : -30 °C to +65 °C (-22 °F to +149 °F)



MATERIALS

- Case : diallylphthalate (DAP)
- Actuator : glass filled polyester
- Bushing : brass, nickel plated
- Housing : stainless steel
- Contacts : silver
- Terminal seal : epoxy

APEM products may be recycled at end-of-life for the re-claiming of valuable metal components.



ELECTRICAL FUNCTION

→ KEYWAY

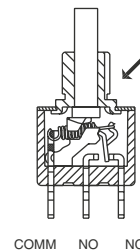

PANEL CUT-OUT

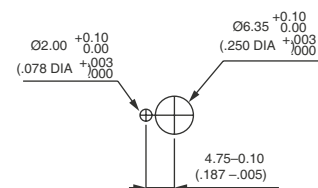

18000 series

Snap-action momentary pushbutton switches • high currents

THREADED BUSHING - SINGLE POLE



18635A



ON



MOM

→ KEYWAY



Also available in double pole configuration.

CAPS

BASIC P/N

+ U...

ROUND

- U2400 Ø 5 (.196)
- U2510 Ø 8 (.314)
- U2130 Ø 9,4 (.370)
- U2900 Ø 10 (.393)
- U3400 Ø 15 (.590)

SQUARE

- U910 Height 4 (.157)
- U2340 Height 6 (.236)

For cap dimensions, see "Caps for Ø 3,1 (.122) plungers" on the preceding pages.

Компания «Life Electronics» занимается поставками электронных компонентов импортного и отечественного производства от производителей и со складов крупных дистрибьюторов Европы, Америки и Азии.

С конца 2013 года компания активно расширяет линейку поставок компонентов по направлению коаксиальный кабель, кварцевые генераторы и конденсаторы (керамические, пленочные, электролитические), за счёт заключения дистрибьюторских договоров

Мы предлагаем:

- Конкуренспособные цены и скидки постоянным клиентам.
- Специальные условия для постоянных клиентов.
- Подбор аналогов.
- Поставку компонентов в любых объемах, удовлетворяющих вашим потребностям.
- Приемлемые сроки поставки, возможна ускоренная поставка.
- Доставку товара в любую точку России и стран СНГ.
- Комплексную поставку.
- Работу по проектам и поставку образцов.
- Формирование склада под заказчика.
- Сертификаты соответствия на поставляемую продукцию (по желанию клиента).
- Тестирование поставляемой продукции.
- Поставку компонентов, требующих военную и космическую приемку.
- Входной контроль качества.
- Наличие сертификата ISO.

В составе нашей компании организован Конструкторский отдел, призванный помогать разработчикам, и инженерам.

Конструкторский отдел помогает осуществить:

- Регистрацию проекта у производителя компонентов.
- Техническую поддержку проекта.
- Защиту от снятия компонента с производства.
- Оценку стоимости проекта по компонентам.
- Изготовление тестовой платы монтаж и пусконаладочные работы.



Тел: +7 (812) 336 43 04 (многоканальный)
Email: org@lifeelectronics.ru