

# 50MHz to 1000MHz, 75dB Logarithmic Detector/Controller

## General Description

The MAX2014 complete multistage logarithmic amplifier is designed to accurately convert radio-frequency (RF) signal power in the 50MHz to 1000MHz frequency range to an equivalent DC voltage. The outstanding dynamic range and precision over temperature of this log amplifier make it particularly useful for a variety of base-station and other wireless applications, including automatic gain control (AGC), transmitter power measurements, and received-signal-strength indication (RSSI) for terminal devices.

The MAX2014 can also be operated in a controller mode where it measures, compares, and controls the output power of a variable-gain amplifier as part of a fully integrated AGC loop.

This logarithmic amplifier provides much wider measurement range and superior accuracy compared to controllers based on diode detectors, while achieving excellent temperature stability over the full -40°C to +85°C operating range.

## Applications

AGC Measurement and Control  
 RF Transmitter Power Measurement  
 RSSI Measurements  
 Cellular Base-Station, WLAN, Microwave Link,  
 Radar, and other Military Applications  
 Optical Networks

*μMAX* is a registered trademark of Maxim Integrated Products, Inc.

## Features

- ◆ Complete RF Detector/Controller
- ◆ 50MHz to 1000MHz Frequency Range
- ◆ Exceptional Accuracy Over Temperature
- ◆ High Dynamic Range
- ◆ 2.7V to 5.25V Supply Voltage Range\*
- ◆ Scaling Stable Over Supply and Temperature Variations
- ◆ Controller Mode with Error Output
- ◆ Shutdown Mode with Typically 1μA of Supply Current
- ◆ Available in 8-Pin TDFN and 8-pin μMAX® Package

\*See the Power-Supply Connections section.

Ordering Information appears at end of data sheet.

## Functional Diagram

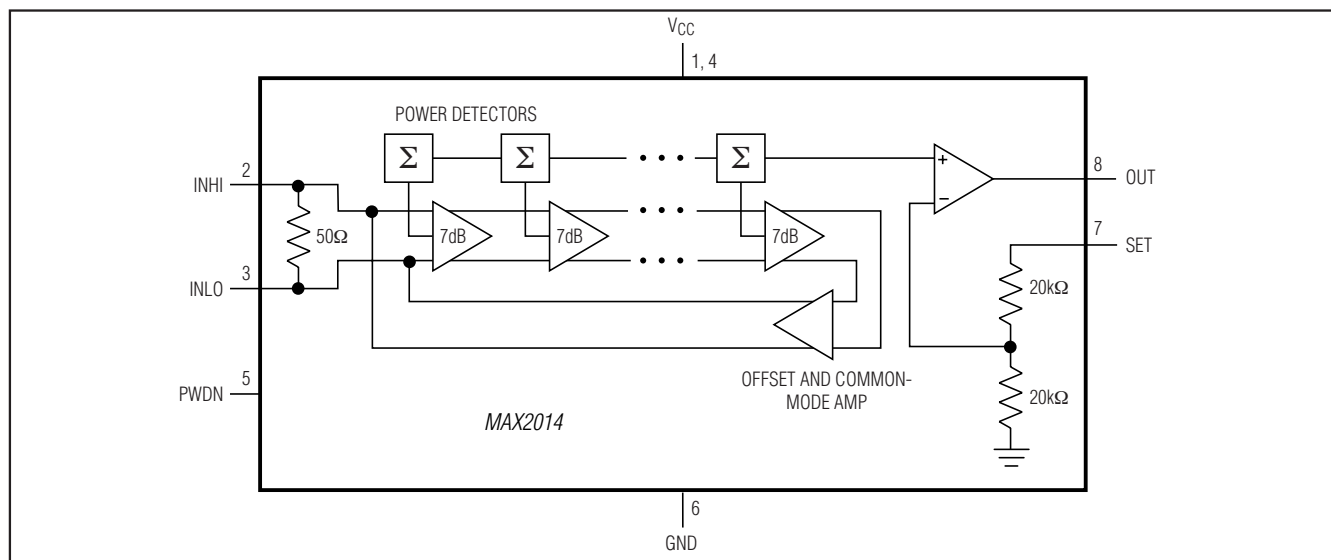

Pin Configuration appears at end of data sheet.

# 50MHz to 1000MHz, 75dB Logarithmic Detector/Controller

## ABSOLUTE MAXIMUM RATINGS

V <sub>CC</sub> (Pins 1, 4) to GND	-0.3V to +5.25V
SET, PWDN to GND	-0.3V to (V <sub>CC</sub> + 0.3V)
Input Power Differential (INHI, INLO)	+23dBm
Input Power Single Ended (INHI or INLO grounded)	+19dBm
Continuous Power Dissipation (T <sub>A</sub> = +70°C)	
TDFN (derate 18.5mW/°C above +70°C)	1480mW
μMAX (derate 4.5mW/°C above +70°C)	362mW

Operating Temperature Range	-40°C to +85°C
Junction Temperature	+150°C
Storage Temperature Range	-65°C to +150°C
Lead Temperature (soldering, 10s)	+300°C
Soldering Temperature (reflow)	+260°C

Stresses beyond those listed under "Absolute Maximum Ratings" may cause permanent damage to the device. These are stress ratings only, and functional operation of the device at these or any other conditions beyond those indicated in the operational sections of the specifications is not implied. Exposure to absolute maximum rating conditions for extended periods may affect device reliability.

## PACKAGE THERMAL CHARACTERISTICS (Note 1)

TDFN:

Junction-to-Ambient Thermal Resistance (θ <sub>JA</sub> )	54°C/W
Junction-to-Case Thermal Resistance (θ <sub>JC</sub> )	8°C/W

μMAX:

Junction-to-Ambient Thermal Resistance (θ <sub>JA</sub> )	221°C/W
Junction-to-Case Thermal Resistance (θ <sub>JC</sub> )	42°C/W

**Note 1:** Package thermal resistances were obtained using the method described in JEDEC specification JESD51-7. For detailed information on package thermal considerations, refer to [www.maxim-ic.com/thermal-tutorial](http://www.maxim-ic.com/thermal-tutorial).

## DC ELECTRICAL CHARACTERISTICS

(Typical Application Circuit (Figure 1), V<sub>S</sub> = +3.3V, f<sub>RF</sub> = 50MHz to 1000MHz, R<sub>1</sub> = 0Ω, R<sub>4</sub> = 0Ω, R<sub>L</sub> = 10kΩ, T<sub>A</sub> = -40°C to +85°C, unless otherwise noted. Typical values are at T<sub>A</sub> = +25°C, unless otherwise noted.) (Note 2)

PARAMETER	SYMBOL	CONDITIONS	MIN	TYP	MAX	UNITS
<b>POWER SUPPLY</b>						
Supply Voltage	V <sub>S</sub>	R <sub>4</sub> = 75Ω ±1%, PWDN must be connected to GND	4.75		5.25	V
		R <sub>4</sub> = 0Ω	2.7		3.6	
Supply Current	I <sub>CC</sub>	T <sub>A</sub> = +25°C, V <sub>S</sub> = 5.25V, R <sub>4</sub> = 75Ω		17.3		mA
		T <sub>A</sub> = +25°C		17.3	20.5	
Supply Current Variation with Temp	I <sub>CC</sub>	T <sub>A</sub> = -40°C to +85°C		0.05		mA/°C
Shutdown Current	I <sub>CC</sub>	V <sub>PWDN</sub> = V <sub>CC</sub>		1		μA
<b>CONTROLLER REFERENCE (SET)</b>						
SET Input Voltage Range				0.5 to 1.8		V
SET Input Impedance				40		kΩ
<b>DETECTOR OUTPUT (OUT)</b>						
Source Current				4		mA
Sink Current				450		μA
Minimum Output Voltage	V <sub>OUT(MIN)</sub>			0.5		V
Maximum Output Voltage	V <sub>OUT(MAX)</sub>			1.8		V

# 50MHz to 1000MHz, 75dB Logarithmic Detector/Controller

MAX2014

## AC ELECTRICAL CHARACTERISTICS

(Typical Application Circuit (Figure 1),  $V_S = +3.3V$ ,  $f_{RF} = 50MHz$  to  $1000MHz$ ,  $R_1 = 0\Omega$ ,  $R_4 = 0\Omega$ ,  $R_L = 10k\Omega$ ,  $T_A = -40^\circ C$  to  $+85^\circ C$ , unless otherwise noted. Typical values are at  $T_A = +25^\circ C$ , unless otherwise noted.) (Note 2)

PARAMETER	SYMBOL	CONDITIONS	MIN	TYP	MAX	UNITS
RF Input Frequency Range	$f_{RF}$			50 to 1000		MHz
Return Loss	$S_{11}$			-15		dB
Large-Signal Response Time		$P_{IN} =$ no signal to $0dBm$ , $\pm 0.5dB$ settling accuracy		150		ns
<b>RSSI MODE—50MHz</b>						
RF Input Power Range		(Note 3)		-65 to +5		dBm
$\pm 3dB$ Dynamic Range		$T_A = -40^\circ C$ to $+85^\circ C$ (Note 4)		70		dB
Range Center				-30		dBm
Temp Sensitivity when $T_A > +25^\circ C$		$T_A = +25^\circ C$ to $+85^\circ C$ , $P_{IN} = -25dBm$		+0.0083		dB/ $^\circ C$
Temp Sensitivity when $T_A < +25^\circ C$		$T_A = -40^\circ C$ to $+25^\circ C$ , $P_{IN} = -25dBm$		-0.0154		dB/ $^\circ C$
Slope		(Note 5)		19		mV/dB
Typical Slope Variation		$T_A = -40^\circ C$ to $+85^\circ C$		-4		$\mu V/^\circ C$
Intercept		(Note 6)		-100		dBm
Typical Intercept Variation		$T_A = -40^\circ C$ to $+85^\circ C$		0.03		dBm/ $^\circ C$
<b>RSSI MODE—100MHz</b>						
RF Input Power Range		(Note 3)		-65 to +5		dBm
$\pm 3dB$ Dynamic Range		$T_A = -40^\circ C$ to $+85^\circ C$ (Note 4)		70		dB
Range Center				-30		dBm
Temp Sensitivity when $T_A > +25^\circ C$		$T_A = +25^\circ C$ to $+85^\circ C$ , $P_{IN} = -25dBm$		+0.0083		dB/ $^\circ C$
Temp Sensitivity when $T_A < +25^\circ C$		$T_A = -40^\circ C$ to $+25^\circ C$ , $P_{IN} = -25dBm$		-0.0154		dB/ $^\circ C$
Slope		(Note 5)		19		mV/dB
Typical Slope Variation		$T_A = -40^\circ C$ to $+85^\circ C$		-4		$\mu V/^\circ C$
Intercept		(Note 6)		-100		dBm
Typical Intercept Variation		$T_A = -40^\circ C$ to $+85^\circ C$		0.03		dBm/ $^\circ C$
<b>RSSI MODE—900MHz</b>						
RF Input Power Range		(Note 3)		-65 to +5		dBm
$\pm 3dB$ Dynamic Range		$T_A = -40^\circ C$ to $+85^\circ C$ (Note 4)		70		dB
Range Center				-30		dBm
Temp Sensitivity when $T_A > +25^\circ C$		$T_A = +25^\circ C$ to $+85^\circ C$ , $P_{IN} = -25dBm$		$\pm 0.0083$		dB/ $^\circ C$

# 50MHz to 1000MHz, 75dB Logarithmic Detector/Controller

## AC ELECTRICAL CHARACTERISTICS (continued)

(Typical Application Circuit (Figure 1),  $V_S = +3.3V$ ,  $f_{RF} = 50MHz$  to  $1000MHz$ ,  $R_1 = 0\Omega$ ,  $R_4 = 0\Omega$ ,  $R_L = 10k\Omega$ ,  $T_A = -40^\circ C$  to  $+85^\circ C$ , unless otherwise noted. Typical values are at  $T_A = +25^\circ C$ , unless otherwise noted.) (Note 2)

PARAMETER	SYMBOL	CONDITIONS	MIN	TYP	MAX	UNITS
Temp Sensitivity when $T_A < +25^\circ C$		$T_A = -40^\circ C$ to $+25^\circ C$ , $P_{IN} = -25dBm$		-0.0154		dB/ $^\circ C$
Slope		(Note 5)		18.1		mV/dB
Typical Slope Variation		$T_A = -40^\circ C$ to $+85^\circ C$		-4		$\mu V/^\circ C$
Intercept		(Note 6)		-97		dBm
Typical Intercept Variation		$T_A = -40^\circ C$ to $+85^\circ C$		0.02		dBm/ $^\circ C$

**Note 2:** The MAX2014 is guaranteed by design for  $T_A = -40^\circ C$  to  $+85^\circ C$ , as specified.

**Note 3:** Typical minimum and maximum range of the detector at the stated frequency.

**Note 4:** Dynamic range refers to the range over which the error remains within the stated bounds. The error is calculated at  $T_A = -40^\circ C$  and  $+85^\circ C$ , relative to the curve at  $T_A = +25^\circ C$ .

**Note 5:** The slope is the variation of the output voltage per change in input power. It is calculated by fitting a root-mean-square (RMS) straight line to the data indicated by RF input power range.

**Note 6:** The intercept is an extrapolated value that corresponds to the output voltage for which the output voltage is zero. It is calculated by fitting an RMS straight line to the data.

## Typical Operating Characteristics

(Typical Application Circuit (Figure 1),  $V_S = V_{CC} = 3.3V$ ,  $P_{IN} = -10dBm$ ,  $f_{IN} = 100MHz$ ,  $R_1 = 0\Omega$ ,  $R_4 = 0\Omega$ ,  $R_L = 10k\Omega$ ,  $V_{PWRN} = 0V$ ,  $T_A = +25^\circ C$ , unless otherwise noted.)

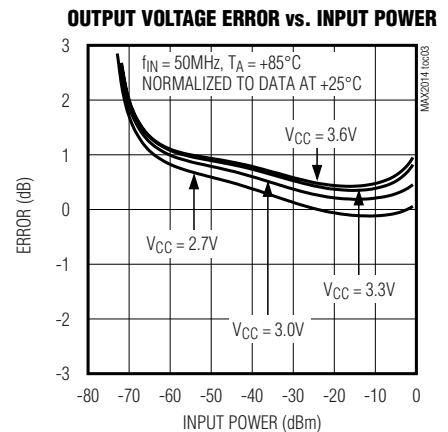
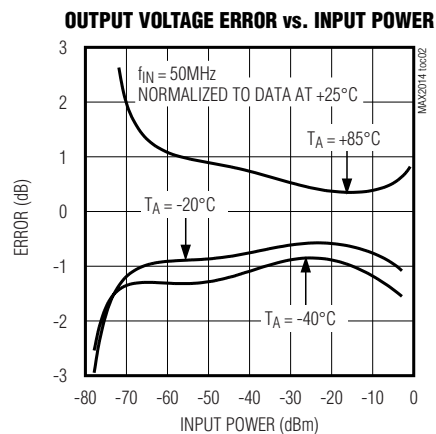
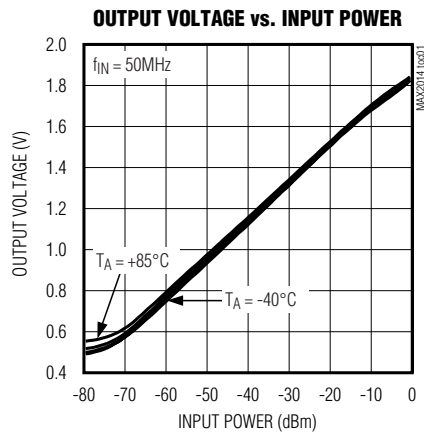

# 50MHz to 1000MHz, 75dB Logarithmic Detector/Controller

MAX2014

## Typical Operating Characteristics (continued)

(Typical Application Circuit (Figure 1),  $V_S = V_{CC} = 3.3V$ ,  $P_{IN} = -10dBm$ ,  $f_{IN} = 100MHz$ ,  $R_1 = 0\Omega$ ,  $R_4 = 0\Omega$ ,  $R_L = 10k\Omega$ ,  $V_{PWDN} = 0V$ ,  $T_A = +25^\circ C$ , unless otherwise noted.)

**OUTPUT VOLTAGE ERROR vs. INPUT POWER**

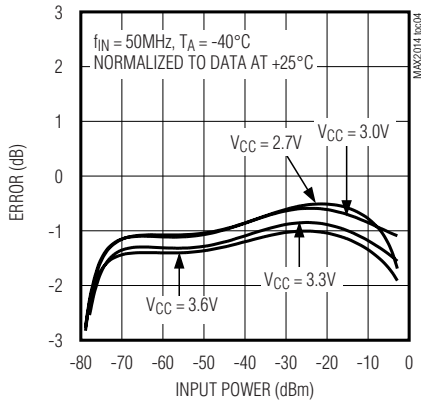

**OUTPUT VOLTAGE vs. INPUT POWER**

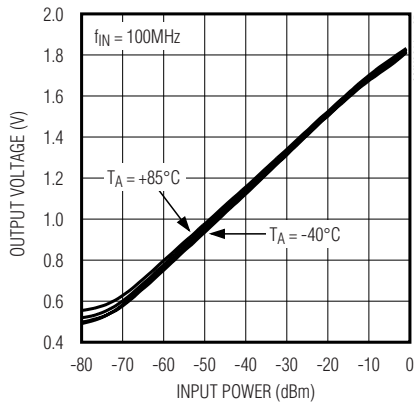

**OUTPUT VOLTAGE ERROR vs. INPUT POWER**

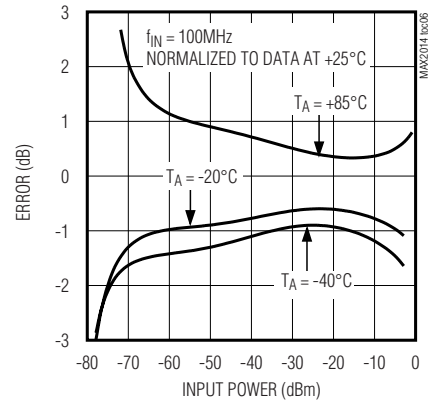

**OUTPUT VOLTAGE ERROR vs. INPUT POWER**

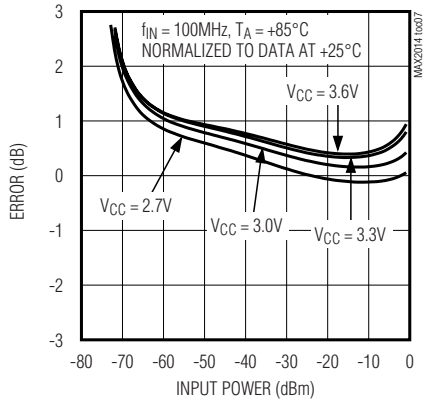

**OUTPUT VOLTAGE ERROR vs. INPUT POWER**

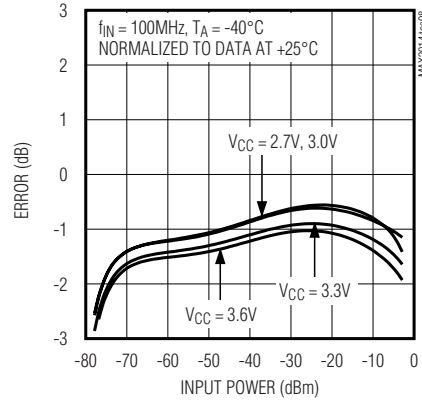

# 50MHz to 1000MHz, 75dB Logarithmic Detector/Controller

## Typical Operating Characteristics (continued)

(Typical Application Circuit (Figure 1),  $V_S = V_{CC} = 3.3V$ ,  $P_{IN} = -10dBm$ ,  $f_{IN} = 100MHz$ ,  $R_1 = 0\Omega$ ,  $R_4 = 0\Omega$ ,  $R_L = 10k\Omega$ ,  $V_{P\_WDN} = 0V$ ,  $T_A = +25^\circ C$ , unless otherwise noted.)

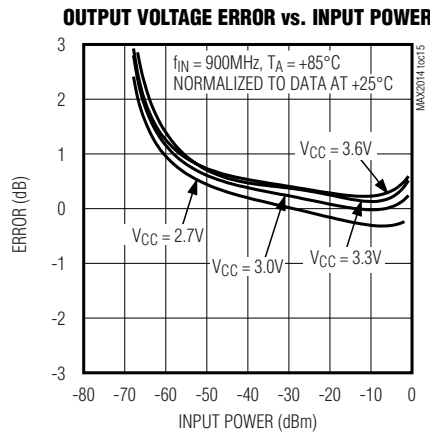
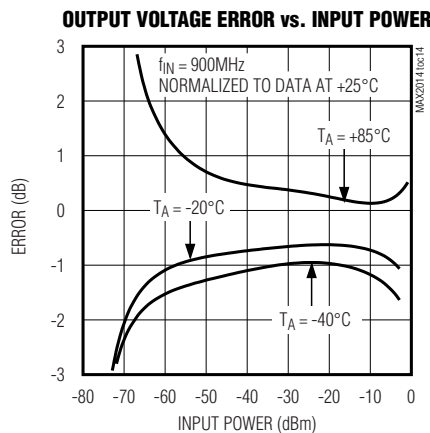
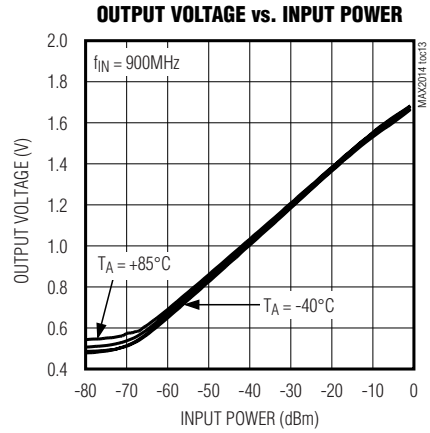
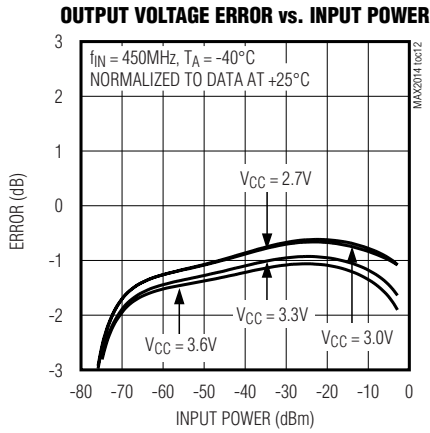
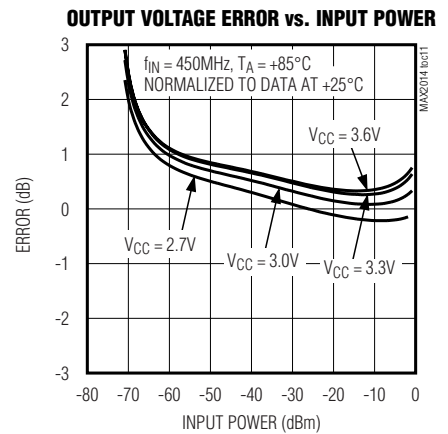
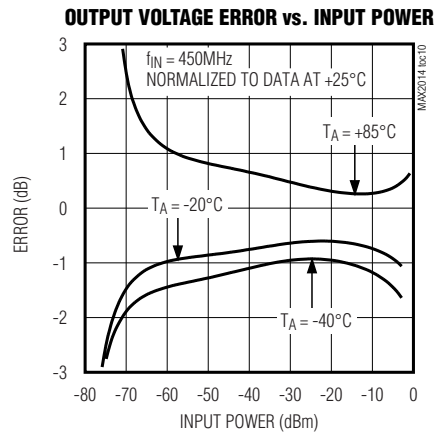
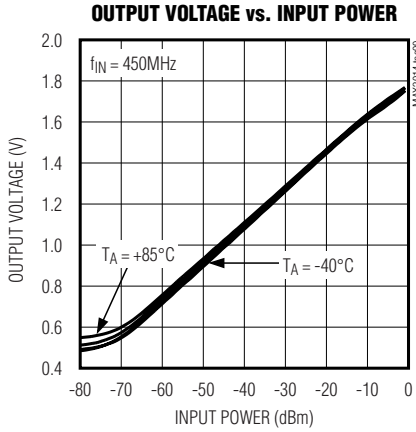

# 50MHz to 1000MHz, 75dB Logarithmic Detector/Controller

MAX2014

## Typical Operating Characteristics (continued)

(Typical Application Circuit (Figure 1),  $V_S = V_{CC} = 3.3V$ ,  $P_{IN} = -10dBm$ ,  $f_{IN} = 100MHz$ ,  $R_1 = 0\Omega$ ,  $R_4 = 0\Omega$ ,  $R_L = 10k\Omega$ ,  $V_{PWRN} = 0V$ ,  $T_A = +25^\circ C$ , unless otherwise noted.)

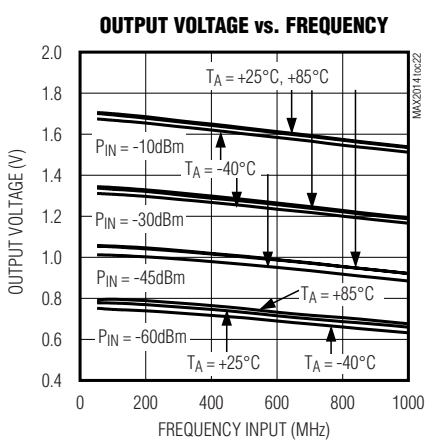
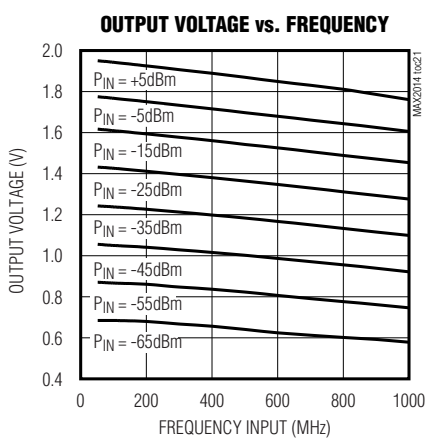
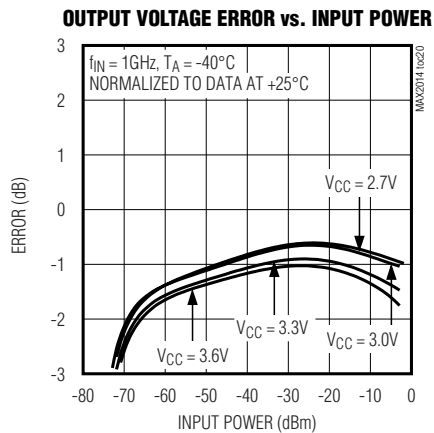
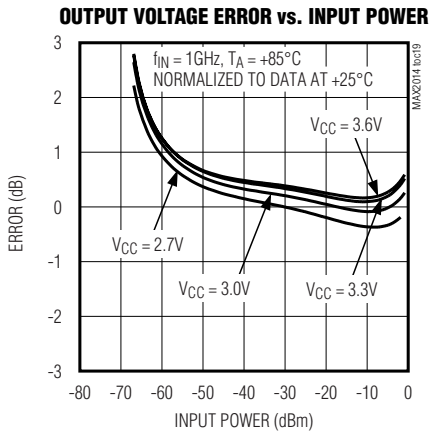
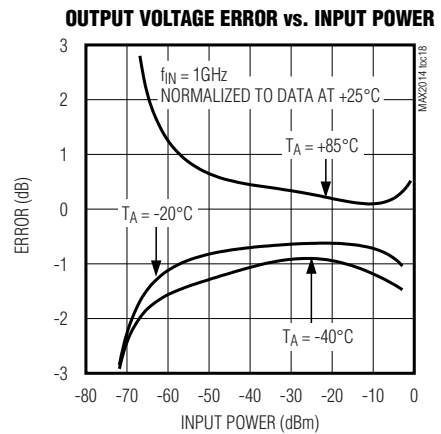
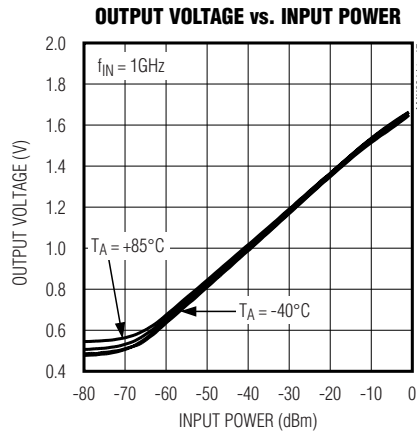
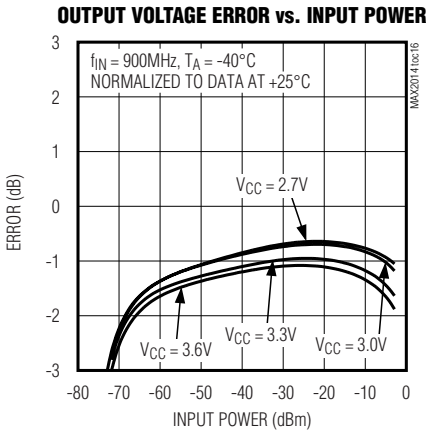

# 50MHz to 1000MHz, 75dB Logarithmic Detector/Controller

## Typical Operating Characteristics (continued)

(Typical Application Circuit (Figure 1),  $V_S = V_{CC} = 3.3V$ ,  $P_{IN} = -10dBm$ ,  $f_{IN} = 100MHz$ ,  $R_1 = 0\Omega$ ,  $R_4 = 0\Omega$ ,  $R_L = 10k\Omega$ ,  $V_{PWDN} = 0V$ ,  $T_A = +25^\circ C$ , unless otherwise noted.)

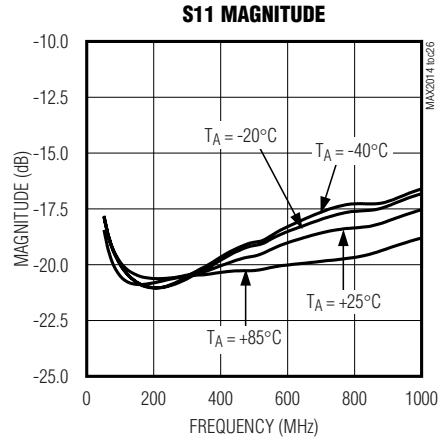
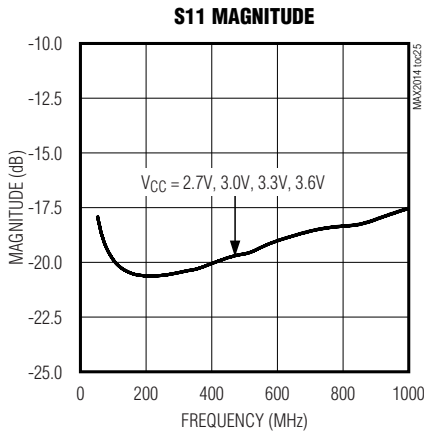
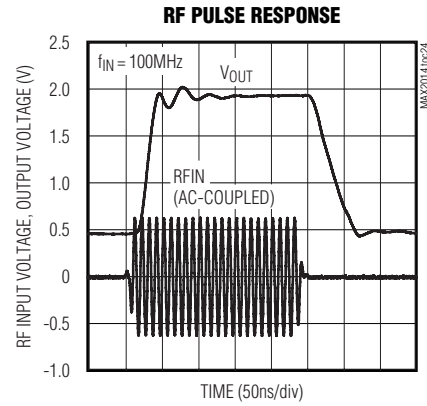
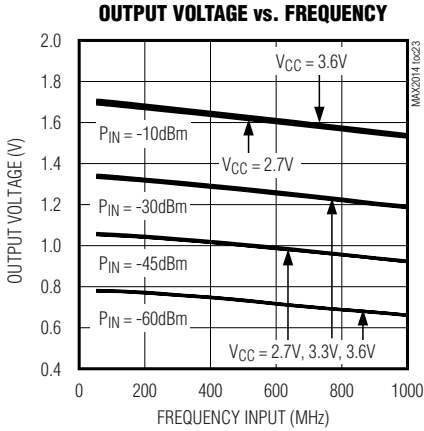

## Pin Description

PIN	NAME	DESCRIPTION
1, 4	$V_{CC}$	Supply Voltage. Bypass with capacitors as specified in the typical application circuits. Place capacitors as close to the pin as possible (see the <i>Power-Supply Connections</i> section).
2, 3	INH1, INLO	Differential RF Inputs
5	PWDN	Power-Down Input. Drive PWDN with a logic-high to power down the IC. PWDN must be connected to GND for $V_S$ between 4.75V and 5.25V with $R_4 = 75\Omega$ .
6	GND	Ground. Connect to the printed circuit (PC) board ground plane.
7	SET	Set-Point Input. To operate in detector mode, connect SET to OUT. To operate in controller mode, connect a precision voltage source to control the power level of a power amplifier.
8	OUT	Detector Output. In detector mode, this output provides a voltage proportional to the log of the input power. In controller mode, this output is connected to a power-control input on a power amplifier (PA).
—	EP	Exposed Pad (TDFN Package Only). Connect EP to GND using multiple vias, or the EP can also be left unconnected.



# 50MHz to 1000MHz, 75dB Logarithmic Detector/Controller

MAX2014

## Detailed Description

The MAX2014 is a successive detection logarithmic amplifier designed for use in RF power measurement and AGC applications with a 50MHz to 1000MHz frequency range from a single 2.7V to 3.6V power supply. It is pin compatible with other leading logarithmic amplifiers.

The MAX2014 provides for improved performance with a high 75dB dynamic range at 100MHz, and exceptional accuracy over the extended temperature range and supply voltage range.

### RF Input

The MAX2014 differential RF input (INHI, INLO) allows for broadband signals between 50MHz and 1000MHz. For single-ended signals, AC-couple INLO to ground. The RF inputs are internally biased and need to be AC-coupled using 680pF capacitors as shown in Figures 1 and 2. An internal 50Ω resistor between INHI and INLO provides a good 50MHz to 1000MHz match.

### SET Input

The SET input is used for loop control when in controller mode or to set the slope of the output signal (mV/dB) when in detector mode. The internal input structure of SET is two series 20kΩ resistors connected to ground. The center node of the resistors is fed to the negative input of the internal output op amp.

### Power-Supply Connections

The MAX2014 requires power-supply bypass capacitors connected close to each VCC pin. At each VCC pin, connect a 0.1μF capacitor (C4, C6) and a 100pF capacitor (C3, C5), with the 100pF capacitor being closest to the pin.

For power-supply voltages (V<sub>S</sub>) between 2.7V and 3.6V, set R4 = 0Ω (see the typical application circuits, Figures 1 and 2).

For power-supply voltages (V<sub>S</sub>) between 4.75V and 5.25V, set R4 = 75Ω ±1% (100ppm/°C max) and PWDN must be connected to GND.

### Power-Down Mode

The MAX2014 can be powered down by driving PWDN with logic-high (logic-high = V<sub>CC</sub>). In power-down mode, the supply current is reduced to a typical value of 1μA. For normal operation, drive PWDN with a logic-low. It is recommended when using power-down that an RF signal not be applied before the power-down signal is low.

## Applications Information

### Detector (RSSI) Mode

In detector mode, the MAX2014 acts like an RSSI, which provides an output voltage proportional to the input power. This is accomplished by providing a feedback path from OUT to SET (R1 = 0Ω; see Figure 1).

By connecting SET directly to OUT, the op amp gain is set to 2V/V due to two internal 20kΩ feedback resistors.

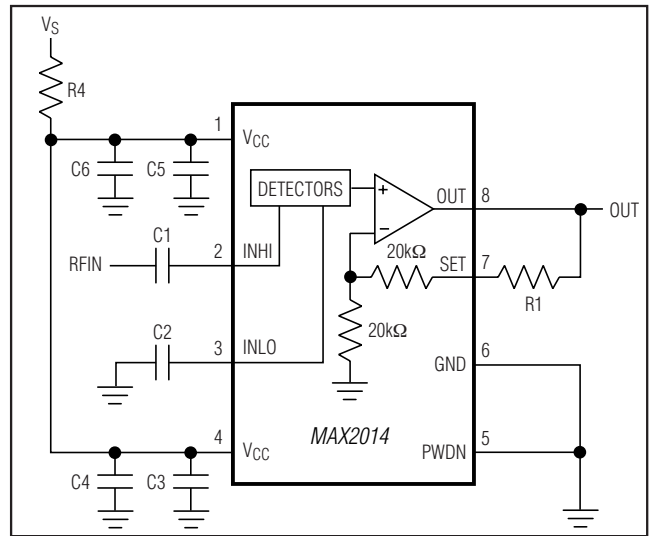

Figure 1. Detector-Mode (RSSI) Typical Application Circuit

Table 1. Suggested Components of Typical Application Circuits

DESIGNATION	VALUE	TYPE
C1, C2	680pF	0603 ceramic capacitors
C3, C5	100pF	0603 ceramic capacitors
C4, C6	0.1μF	0603 ceramic capacitors
R1*	0Ω	0603 resistor
R4**	0Ω	0603 resistor

\*RSSI mode only.

\*\*V<sub>S</sub> = 2.7V to 3.6V.

This provides a detector slope of approximately 18mV/dB with a 0.5V to 1.8V output range.

### Controller Mode

The MAX2014 can also be used as a detector/controller within an AGC loop. Figure 3 depicts one scenario where the MAX2014 is employed as the controller for a

# 50MHz to 1000MHz, 75dB Logarithmic Detector/Controller

variable-gain PA. As shown in the figure, the MAX2014 monitors the output of the PA through a directional coupler. An internal integrator (Figure 2) compares the detected signal with a reference voltage determined by  $V_{SET}$ . The integrator, acting like a comparator, increases or decreases the voltage at OUT, according to how closely the detected signal level matches the  $V_{SET}$  reference. The MAX2014 adjusts the power of the PA to a level determined by the voltage applied to SET. With  $R1 = 0\Omega$ , the controller mode slope is approximately 19mV/dB (RF = 100MHz).

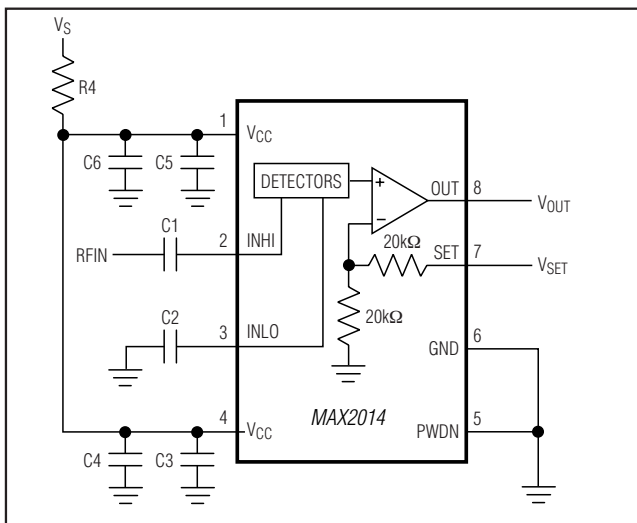

Figure 2. Controller-Mode Typical Application Circuit

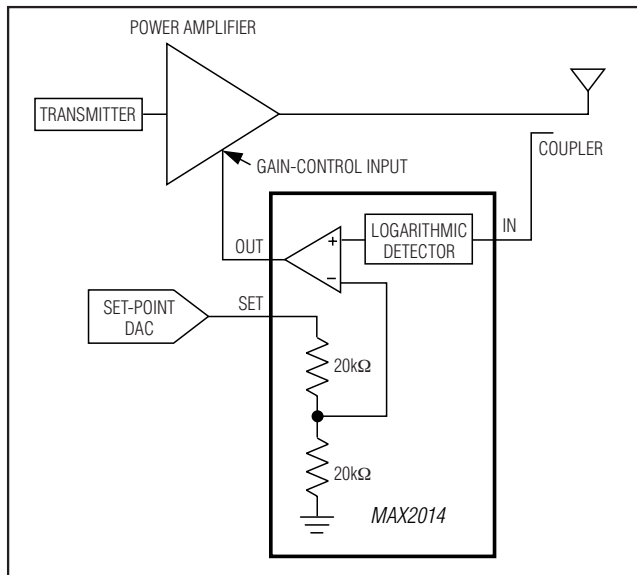
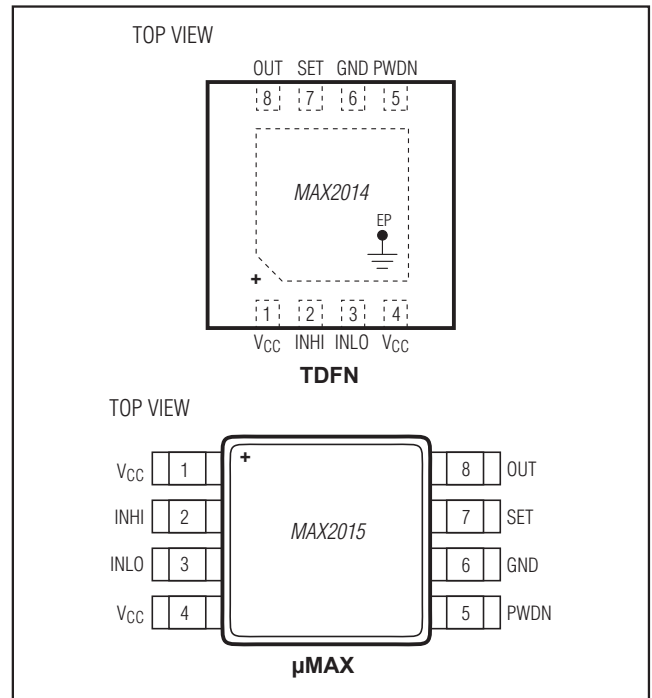

Figure 3. System Diagram for Automatic Gain-Control Loop

## Layout Considerations

As with any RF circuit, the layout of the MAX2014 circuit affects the device's performance. Use an abundant number of ground vias to minimize RF coupling. Place the input capacitors (C1, C2) and the bypass capacitors (C3–C6) as close to the IC as possible. Connect the bypass capacitors to the ground plane with multiple vias.

## Pin Configurations



# 50MHz to 1000MHz, 75dB Logarithmic Detector/Controller

MAX2014

## Package Information

For the latest package outline information and land patterns (footprints), go to [www.maxim-ic.com/packages](http://www.maxim-ic.com/packages). Note that a "+", "#", or "-" in the package code indicates RoHS status only. Package drawings may show a different suffix character, but the drawing pertains to the package regardless of RoHS status.

PACKAGE TYPE	PACKAGE CODE	OUTLINE NO.	LAND PATTERN NO.
8 TDFN-EP	T833+2	<a href="#">21-0137</a>	<a href="#">90-0059</a>
8 $\mu$ MAX	U8+1	<a href="#">21-0036</a>	<a href="#">90-0092</a>

## Ordering Information

PART	TEMP RANGE	PIN-PACKAGE
MAX2014ETA+	-40°C to +85°C	8 TDFN-EP*
MAX2014ETA+T	-40°C to +85°C	8 TDFN-EP*
MAX2014EUA+	-40°C to +85°C	8 $\mu$ MAX
MAX2014EUA+T	-40°C to +85°C	8 $\mu$ MAX

+Denotes a lead(Pb)-free/RoHS-compliant package.

\*EP = Exposed pad.

T = Tape and reel.

## Chip Information

PROCESS: BiCMOS

# 50MHz to 1000MHz, 75dB Logarithmic Detector/Controller

## Revision History

REVISION NUMBER	REVISION DATE	DESCRIPTION	PAGES CHANGED
0	6/06	Initial release	—
1	2/12	Added $\mu$ MAX package and updated style	1-7, 9, 10

Maxim cannot assume responsibility for use of any circuitry other than circuitry entirely embodied in a Maxim product. No circuit patent licenses are implied. Maxim reserves the right to change the circuitry and specifications without notice at any time. The parametric values (min and max limits) shown in the Electrical Characteristics table are guaranteed. Other parametric values quoted in this data sheet are provided for guidance.

12 **Maxim Integrated Products, 160 Rio Robles, San Jose, CA 95134 408-601-1000**

Компания «Life Electronics» занимается поставками электронных компонентов импортного и отечественного производства от производителей и со складов крупных дистрибьюторов Европы, Америки и Азии.

С конца 2013 года компания активно расширяет линейку поставок компонентов по направлению коаксиальный кабель, кварцевые генераторы и конденсаторы (керамические, пленочные, электролитические), за счёт заключения дистрибьюторских договоров

Мы предлагаем:

- Конкурентоспособные цены и скидки постоянным клиентам.
- Специальные условия для постоянных клиентов.
- Подбор аналогов.
- Поставку компонентов в любых объемах, удовлетворяющих вашим потребностям.
- Приемлемые сроки поставки, возможна ускоренная поставка.
- Доставку товара в любую точку России и стран СНГ.
- Комплексную поставку.
- Работу по проектам и поставку образцов.
- Формирование склада под заказчика.
- Сертификаты соответствия на поставляемую продукцию (по желанию клиента).
- Тестирование поставляемой продукции.
- Поставку компонентов, требующих военную и космическую приемку.
- Входной контроль качества.
- Наличие сертификата ISO.

В составе нашей компании организован Конструкторский отдел, призванный помогать разработчикам, и инженерам.

Конструкторский отдел помогает осуществить:

- Регистрацию проекта у производителя компонентов.
- Техническую поддержку проекта.
- Защиту от снятия компонента с производства.
- Оценку стоимости проекта по компонентам.
- Изготовление тестовой платы монтаж и пусконаладочные работы.



Тел: +7 (812) 336 43 04 (многоканальный)  
Email: [org@lifeelectronics.ru](mailto:org@lifeelectronics.ru)