



LRS Series AC-DC Subrack Systems MK007

MK007 is a power supply system designed for railway and subway application. The applicable railway standards, mainly EN 50155, EN 50121-4, and the respective AREMA standards are observed. The power supply system is designed to accommodate special LK converters, such as LK5542-9ERD8TG or LK5662-9ERD8TG.

A main feature is the enhanced voltage isolation (3000 VAC) between outputs, alarm signals, and the metallic chassis respectively the ground.

The system consists of one or two racks. Each rack can accommodate up to 4 converters, which allows redundant configuration in terms of input and output energy. The power supply rack system supports also battery charging with temperature sensors controlling the LK converters.

A floating relay contact is available to monitor the function of each converter.



Features

- Compliant to AREMA, EN 50155, and EN 50121-4
- RoHS-compliant for all 6 substances
- 5 year warranty
- 19-inch rack system, convection cooling
- Different output configurations
- Extremely rugged, reliable design for harsh environment
- Class I equipment
- Extremely high isolation of all output circuits
- Excellent surge and transient protection
- Wide input voltage range 85 to 264 VAC, 50 to 60 Hz
- Power factor >0.93, harmonics IEC/EN 61000-3-2
- Output voltage adjust
- Active output current sharing
- Output voltage monitor with relay contacts
- Inrush current limitation
- PCBs with conformal coating – except PCBs of the rack
- Hot swappable

Safety-approved to the latest edition of IEC/EN 60950-1 and UL/CSA 60950-1.



Table of Contents

	Page		Page
Description.....	1	Electromagnetic Compatibility (EMC).....	12
Model Selection.....	2	Immunity to Environmental Conditions.....	13
Functional Description.....	5	Mechanical Data.....	14
Electrical Input Data.....	7	Safety and Installation Instructions.....	17
Electrical Output Data.....	9	Battery Charging /Temperature Sensor.....	19

Model Selection

The system consists of converters and racks.

Table 1: Converters. Other output configurations or special customer adaptations are available on request.

Output 1		Output 2		Operating input range		Type designation	Efficiency	
$V_{o\ nom}$ [VDC]	$I_{o\ nom}$ [A]	$V_{o\ nom}$ [VDC]	$I_{o\ nom}$ [A]	$V_{i\ min} - V_{i\ max}$ [VAC]	$f_{i\ min} - f_{i\ max}$ [Hz]		η_{min}^1 [%]	η_{typ} [%]
15	5	15 ²	5	85 – 264	47 – 63 ³	LK5542-9ERD8TG	83	85
24	3	24 ²	3	85 – 264	47 – 63 ³	LK5662-9ERD8TG	82	84

¹ Min. efficiency at $V_i = 230\text{ V}$, $I_{o\ nom}$ and $T_A = 25\text{ °C}$

² Second output semi-regulated



³ Operating frequencies >60 Hz are possible with some restrictions; see web data sheet of the LK PFC Series (BCD20002-G).

Table 2a: Single output systems (see Fig. 2a). Other configurations or special customer adaptations are available on request.

Type designation of the system	Output current		Redundancy	Population	Configuration of the converters in the rack ¹
	V _{o nom}	I _{o nom}			
MK007-001G – for LK5542 MK007-100G – for LK5662 (Rack with backplane, but without converters)					
Subrack Systems	LRS10-15-900G	1 x 15 V	1 x 10 A	no	1x LK5542
	LRS06-24-900G	1 x 24 V	1 x 6 A	no	1x LK5662
	LRS05-28-900G	1 x 28 V	1 x 5 A	no	1x LK5542 ³
	LRS05-30-900G	1 x 30 V	1 x 5 A	no	1x LK5542
	LRS03-48-900G	1 x 48 V	1 x 3 A	no	1x LK5662
	LRS03-50-900G	1 x 50 V	1 x 3 A	no	1x LK5662
	LRS20-15-900G	1 x 15 V	1 x 20 A	no	2x LK5542
	LRS12-24-900G	1 x 24 V	1 x 12 A	no	2x LK5662
	LRS10-28-900G	1 x 28 V	1 x 10 A	no	2x LK5542 ³
	LRS10-30-900G	1 x 30 V	1 x 10 A	no	2x LK5542
	LRS06-48-900G	1 x 48 V	1 x 6 A	no	2x LK5662
	LRS06-50-900G	1 x 50 V	1 x 6 A	no	2x LK5662
	LRS10-15-901G	2 x 15 V	2 x 10 A	yes	2x LK5542
	LRS06-24-901G	2 x 24 V	2 x 6 A	yes	2x LK5662
	LRS05-28-901G	2 x 28 V	2 x 5 A	yes	2x LK5542 ³
	LRS05-30-901G	2 x 30 V	2 x 5 A	yes	2x LK5542 ²
	LRS03-48-901G	2 x 48 V	2 x 3 A	yes	2x LK5662
	LRS03-50-901G	2 x 50 V	2 x 3 A	yes	2x LK5662
	LRS30-15-900G	1 x 15 V	1 x 30 A	no ²	3x LK5542
	LRS18-24-900G	1 x 24 V	1 x 18 A	no ²	3x LK5662
	LRS15-28-900G	1 x 28 V	1 x 15 A	no ²	3x LK5542 ³
	LRS15-30-900G	1 x 30 V	1 x 15 A	no ²	3x LK5542
	LRS09-48-900G	1 x 48 V	1 x 9 A	no ²	3x LK5662
	LRS09-50-900G	1 x 50 V	1 x 9 A	no ²	3x LK5662
	LRS20-15-901G	2 x 15 V	2 x 20 A	yes	4x LK5542
	LRS12-24-901G	2 x 24 V	2 x 12 A	yes	4x LK5662
	LRS10-28-901G	2 x 28 V	2 x 10 A	yes	4x LK5542 ³
	LRS10-30-901G	2 x 30 V	2 x 10 A	yes	4x LK5542
	LRS06-48-901G	2 x 48 V	2 x 6 A	yes	4x LK5662
	LRS06-50-901G	2 x 50 V	2 x 6 A	yes	4x LK5662
	LRS40-15-900G	1 x 15 V	1 x 40 A	no ²	4x LK5542
	LRS24-24-900G	1 x 24 V	1 x 24 A	no ²	4x LK5662
LRS20-28-900G	1 x 28 V	1 x 20 A	no ²	4x LK5542 ³	
LRS20-30-900G	1 x 30 V	1 x 20 A	no ²	4x LK5542	
LRS12-48-900G	1 x 48 V	1 x 12 A	no ²	4x LK5662	
LRS12-50-900G	1 x 50 V	1 x 12 A	no ²	4x LK5662	

- 1 Positions without converter are covered with blank panels
- 2 Connect output A and B in parallel
- 3 Converters LK5542 with both output in series connection, trimmed to 14 V

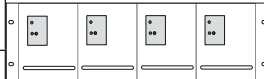
Table 2b: Dual output systems (see Fig. 2b). Other configurations or special customer adaptations are available on request.

Type designation of the system	Output current		Redundancy	AC input connection	Population	Configuration of the converters in the rack ¹
	V _{o nom}	I _{o nom}				
MK007-200G (Rack with backplane, but without converters)						
LRS0506-3024-951G ²	1 x 30 V (± 15 V) 1 x 24 V	1 x 5 A (2x 5 A) 1 x 6 A	yes	A: L~ :Pos2, Pos3 B: L~ :Pos1, Pos4 magenta connection	2 x LK5542 2 x LK5662	

- ¹ Positions without converter are covered with blank panels
- ² With customer-specific logos
- ³ Converters LK5542 with both output in series connection, trimmed to 14 V

Part Number Description for Single Output System

LRS 20-15-9 0 1 Sxxx G

Series (product family).....LRS
 Output current..... 05, 06, 10, 12, 15, 20, 30, 40
 Output voltage 15, 24, 28, 30, 48, 50
 Operating ambient temperature range
 T_A = -40 to +71 °C -9
 Options: Bel Power logo on front panel.....0
 Custom logo on front panel.....5
 Features: Redundancy (no, yes)..... 0, 1
 Customer specific model.....Sxxx¹
 RoHS-compliant for all 6 substancesG

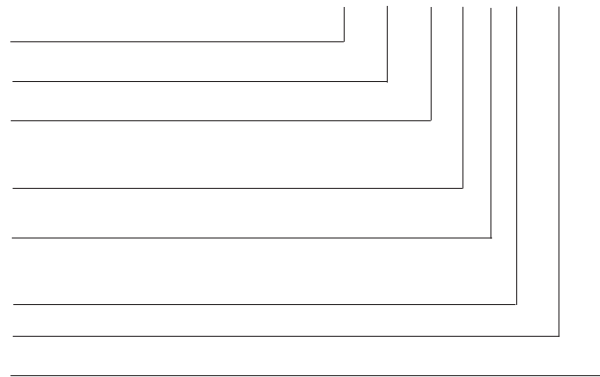

¹ Applicable for non safety critical deviations. xxx are 3 digits assigned for each customer-specific model

Part Number Description for Dual Output System

LRS 05 06 - 30 24 - 9 5 1 G

Series (product family).....LRS
 Output current I_{oA} 05, 06, 10, 12, 15, 20, 30, 40
 I_{oB} 05, 06, 10, 12, 15, 20, 30, 40
 Output voltage Vo_A..... 15, 24, 28, 30, 48, 50
 Vo_B 15, 24, 28, 30, 48, 50
 Operating ambient temperature range
 T_A = -40 to +71 °C -9
 Options: Bel Power logo on front panel.....0
 Custom logo on front panel.....5
 Features: Redundancy (no, yes)..... 0, 1
 Customer specific model.....Sxxx¹
 RoHS-compliant for all 6 substancesG

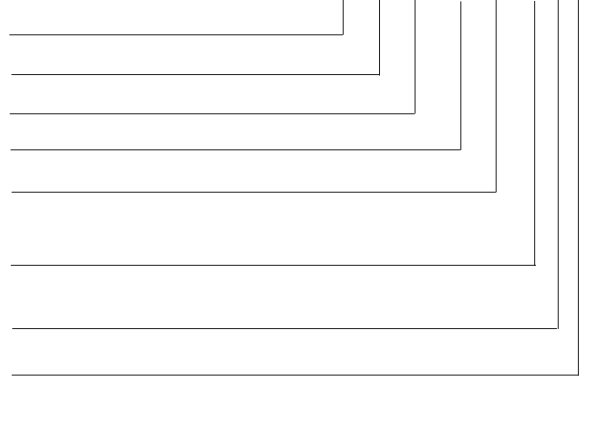

¹ Applicable for non safety critical deviations. xxx are 3 digits assigned for each customer-specific model

Functional Description

The input voltage is supplied to up to 4 converters type LK5542/LK5662. The outputs of 2 converters in each half of rack are connected together through OR-ing diodes. These 2 converters share their output current evenly due their current share feature.

The converters LK5542 has two outputs with 15 V and the LK5662 have two outputs with 24 V, which can be connected in parallel or in series. The connection of the outputs is done in the factory by the output voltage selector on the backplane. The output voltage can be adjusted by an external resistor located in the backplane (one resistor per converter) in the range of 80 to 110% of the output voltage. For the use as battery charger, an external thermal sensor can be connected to regulate the trickle charge voltage dependant on the battery temperature.

The output voltage is monitored in each converter. When the output voltage is in range, a relay with an isolated contact is activated. All relay contacts are connected to the alarm signal connectors.

The redundancy of the whole system is depending on the numbers of the converters; see Table 2.

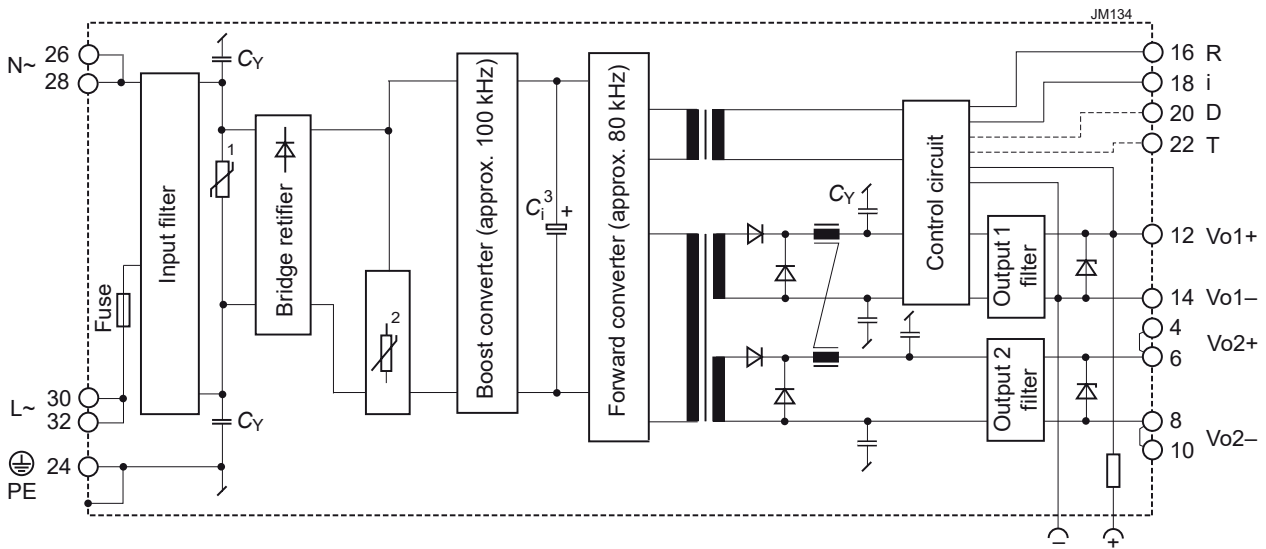

- 1 Transient suppressor (VDR)
- 2 Inrush current limiter (with opt. E)
- 3 Bulk capacitor

Fig. 1
Block diagram of a converter

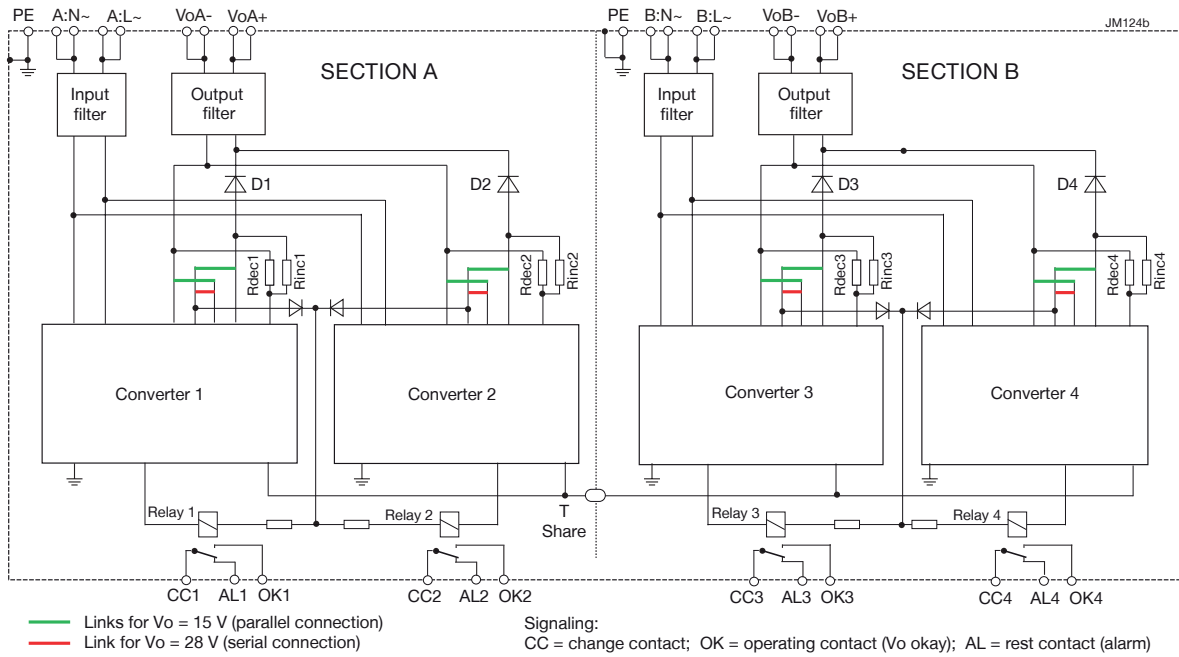

Fig. 2a - Single output system

Block diagram of the rack. The converters in the different positions are fitted depending on the configuration; see table 2. The green connections are valid for the parallel configuration with 15 V or 24 V output, the red connections for serial configuration with 28 V or 50 V output. For details of contacts and wires, see Mechanical Data.

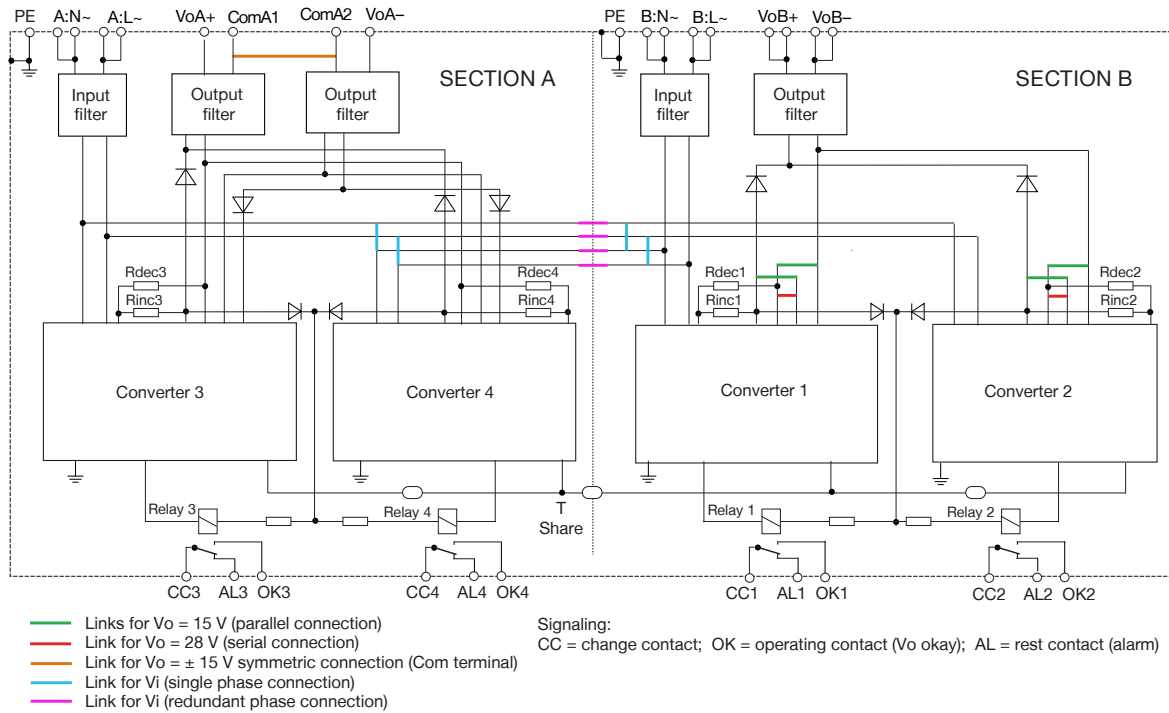

Fig. 2b Dual output system

Block diagram of the rack. The converters in the different positions are fitted depending on the configuration; see table 2. Section A & B: The magenta connection is valid for operation on two independent AC input voltages. Cyan connection is valid for operation on one single AC input voltage. Section A: The orange connection is valid for $\pm V_o$ symmetric connection (Com terminal). Section B: The green connections are valid for the parallel configuration with 15 V or 24 V output, the red connections for serial configuration with 28 V, 30 V, 48V or 50 V output. For details of contacts and wires, see Mechanical Data.

Electrical Input Data

General Conditions:

- $T_A = 25\text{ °C}$, unless T_C is specified.
- Pin 18 connected to pin 14, R input not connected.

Table 3: Electrical input data per converter

Input			LK5542-9ERD8TG			LK5662-9ERD8TG			Unit
Characteristics		Conditions	min	typ	max	min	typ	max	
V_i	Rated input voltage range	$I_o = 0 - I_{o\text{ nom}}$ $T_{C\text{ min}}$ to $T_{C\text{ max}}$	100		240	100		240	VAC ¹
$V_{i\text{ op}}$	Operating input voltage range		85		264	85		264	
$V_{i\text{ nom}}$	Nominal input voltage	50 – 60 Hz ¹	115 / 230			115 / 230			
I_i	Input current per converter	$V_i = 230\text{ V}$, $I_{o\text{ nom}}$ ²	0.8			0.8			A
P_{i0}	No-load input power per converter	$V_{i\text{ min}} - V_{i\text{ max}}$, $I_o = 0$	9 12			9 12			W
C_b	Input capacitance per converter		100	150	180	100	150	180	μF
$V_{i\text{ abs}}$	Input voltage limits without damage		283			283			VAC
			-400		400 ³	-400		400 ³	VDC ³

¹ Rated input frequency: 50 – 60 Hz, operating input frequency: 47 – 63 Hz. Higher frequencies are possible with some restrictions; see web data sheet of the LK PFC Series (BCD20002)

² Outputs loaded with $I_{o\text{ nom}}$

³ For $\leq 1\text{ s}$.

Input Fuse and Protection of the Converters

A VDR together with the input fuse and a symmetrical input filter form an effective protection against high input transient voltages.

Input fuse: slow-blow, SP T, 4 A, 250 V, 5 × 20 mm

Input Under-/Overvoltage Lockout

If the input voltage remains below approx. 65 VAC or exceeds $V_{i\text{ abs}}$, an internally generated inhibit signal disables the outputs. Do not check the overvoltage lockout function!

If V_i is below $V_{i\text{ min}}$, but above the undervoltage lockout level, the output voltage may be below the value specified in the tables *Electrical Output Data*.

Power Factor and Harmonics

Power factor correction is achieved by controlling the input current waveform synchronously with the input voltage waveform. The power factor control is active under all operating conditions.

Harmonic distortions are below the limits specified in IEC/EN 61000-3-2, class D.

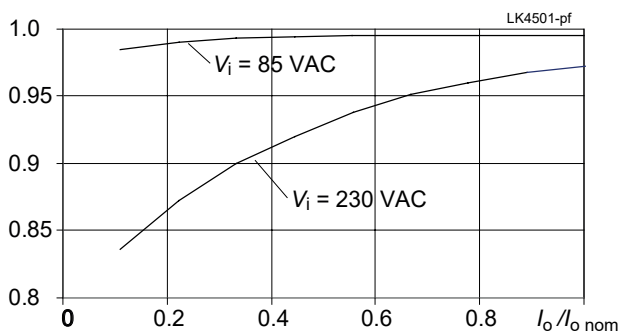

Fig. 3
Power factor versus output current

Efficiency

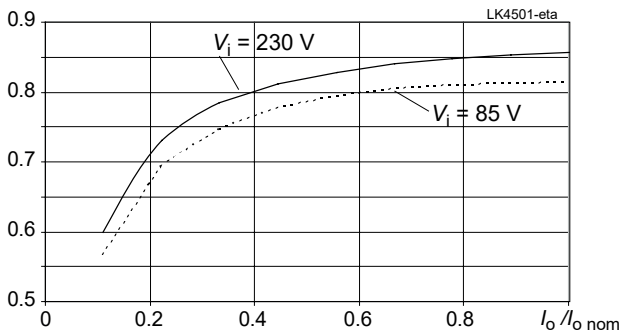

Fig. 4
Efficiency versus output current

Hold-up time

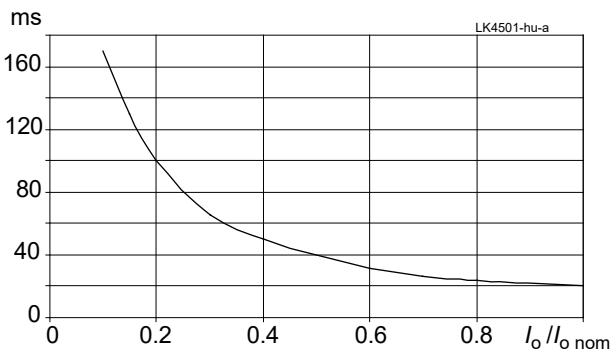

Fig. 5
Hold-up time versus output power

Inrush Current Limitation

The converters exhibit an electronic circuit to limit the inrush current at switch-on.

Note: Subsequent switch-on cycles at start-up are limited to max. 10 cycles during the first 20 seconds (cold converter) and then to max. 1 cycle every 8s.

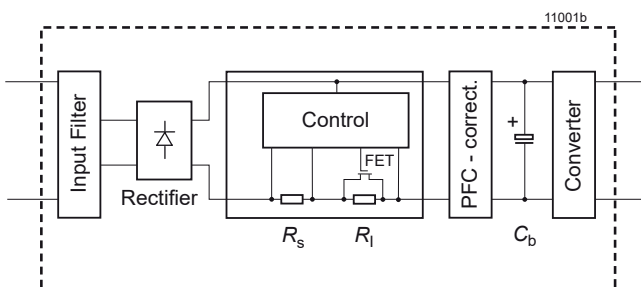

Fig. 6
Inrush current limitation, schematic diagram

Table 4: Inrush current characteristics per converter

Characteristics $V_i = 230 \text{ VAC}$		Inrush current			Unit
		min	typ	max	
$I_{inr p}$	Peak inrush current		–	25.3	A
t_{inr}	Inrush current duration		35	50	ms

Electrical Output Data

Table 5a: Output data of the converter

Model			LK5542 Output 1 + 2 in series			LK5662 Output 1 + 2 in series			Unit
Characteristics		Conditions	min	typ	max	min	typ	max	
V_o	Output voltage	$V_{i\ nom}, I_{o\ nom}$	30 (28) ¹			48 (50) ¹			V
$I_{o\ nom}$	Output current nom.	$V_{i\ min} - V_{i\ max}$ $T_{C\ min} - T_{C\ max}$	5.0			3.0			A
I_{oL}	Output current limit	$V_{i\ min} - V_{i\ max}$	5.2			3.2			
$\Delta V_{o\ u}$	Static line regulation with respect to $V_{i\ nom}$	$V_{i\ min} - V_{i\ max}$ $I_{o\ nom}$	±30			±40			mV
$\Delta V_{o\ l}$	Static load regulation ¹	$V_{i\ nom}$ $(0.1 - 1) I_{o\ nom}$	-100			-100			
α_{vo}	Temperature coefficient of output voltage	$T_{C\ min} - T_{C\ max}$ $I_{o\ nom}$	±0.02			±0.02			%/K

¹ Output voltage adjusted on the backplane of the rack.

Table 5b: Output data of the converter

Model			LK5542 Output 1 + 2 in parallel			LK5662 Output 1 + 2 in parallel			Unit
Characteristics		Conditions	min	typ	max	min	typ	max	
V_o	Output voltage	$V_{i\ nom}, I_{o\ nom}$	15			24			V
$I_{o\ nom}$	Output current nom.	$V_{i\ min} - V_{i\ max}$ $T_{C\ min} - T_{C\ max}$	10			6.0			A
I_{oL}	Output current limit	$V_{i\ min} - V_{i\ max}$	10.4			6.4			
$\Delta V_{o\ u}$	Static line regulation with respect to $V_{i\ nom}$	$V_{i\ min} - V_{i\ max}$ $I_{o\ nom}$	±15			±25			mV
$\Delta V_{o\ l}$	Static load regulation ¹	$V_{i\ nom}$ $(0.1 - 1) I_{o\ nom}$	-60			-100			
α_{vo}	Temperature coefficient of output voltage	$T_{C\ min} - T_{C\ max}$ $I_{o\ nom}$	±0.02			±0.02			%/K

Thermal Protection of the Converters

A temperature sensor generates an internal inhibit signal, which disables the outputs when the case temperature exceeds the value $T_{C\ max}$. The outputs automatically recover, when the temperature drops below this limit.

Continuous operation under simultaneous extreme worst-case conditions of the following three parameters should be avoided: Minimum input voltage, maximum output power, and maximum temperature.

Output Protection of the Converters

Each output is protected by a suppressor diode against overvoltage, which could occur due to a failure of the control circuit. In such a case, the suppressor diode becomes a short circuit and $V_o = 0$. A short circuit at any of the two outputs will cause a shutdown of the other output. A red LED indicates any overload condition.

Output Voltage Regulation of the Converters

The following figures apply to double-output models with parallel-connected outputs.

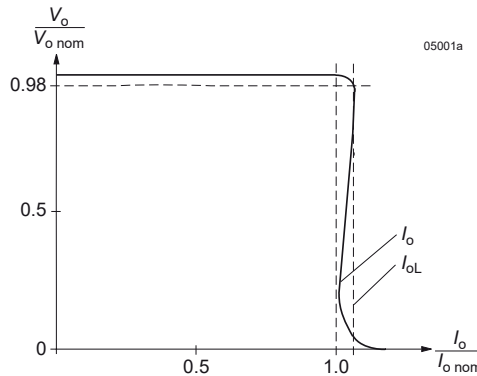

Fig. 7. Typical output characteristic V_o versus I_o .

Output Voltage Monitor of the Converters

An output undervoltage monitoring circuit (D8) is integrated to each converter. A logic “high” signal (NPN output) is generated at the D output (pin 20), when the monitored voltage V_{o1} drops below the preselected threshold level V_t . This signal is referenced to $S-/Vo1-$. The D output recovers, when the monitored voltages exceed $V_t + V_h$. The threshold level is adjusted in the factory to a fixed value suitable for the application.

This output activates a relay located on the backplane MK007 with a floating contact, which is closed when the output voltage of the respective converter is present.

Output Voltage Adjust of the Converters

The control input R (pin 16) allows for adjusting the output voltage by means of an external resistor. When pin 16 is not connected, the output voltage is set to $V_{o nom}$. If the converters are inserted in the rack, use **Rinc** or **Rdec** according to fig. 13.

Note: Only 1 converter can be adjusted at once. Pull out all other converters, to adjust the first one, then repeat this procedure with all other converters.

Depending on the value of the required output voltage, the resistor must be connected:

either between pin 16 and pin 14 ($V_o < V_{o nom}$) to achieve an output voltage adjustment range of approximately 0 – 100% of $V_{o nom}$. If the converter is in the rack, use **Rdec** (fig. 13).

or between pin 16 and pin 12 ($V_o > V_{o nom}$) to achieve an output voltage adjustment range of 100 – 110% of $V_{o nom}$. If the converter is in the rack, use **Rinc** (fig. 13).

The second output of double-output models follows the value of the controlled main output.

Current Sharing between Converters

This feature ensures that the output currents are approximately shared between all parallel-connected converters, hence increasing system reliability. To use this facility, simply interconnect the T pins of all converters and make sure that the references for the T signal ($Vo1-$, pin 14) are also connected together.

Display Status of LEDs

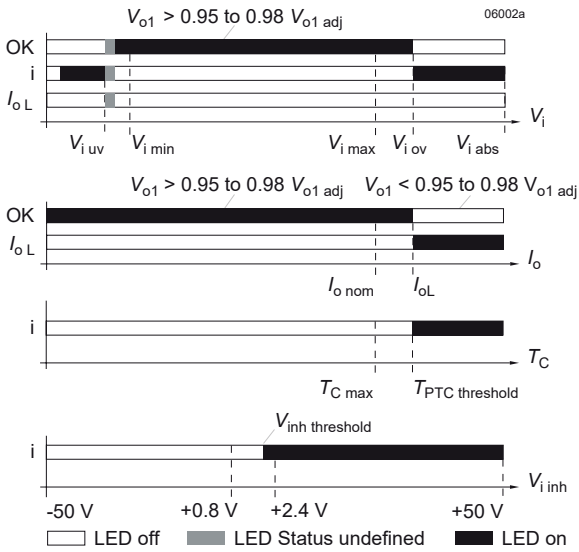

LEDs "OK", "i" and "I_{oL}" status versus input voltage
Conditions: $I_o \leq I_{o\ nom}$, $T_C \leq T_{C\ max}$, $V_{inh} \leq 0.8\ V$
 $V_{i\ uv}$ = undervoltage lock-out, $V_{i\ ov}$ = overvoltage lock-out

LEDs "OK" and "I_{oL}" status versus output current
Conditions: $V_{i\ min} - V_{i\ max}$, $T_C \leq T_{C\ max}$, $V_{inh} \leq 0.8\ V$

LED "i" versus case temperature
Conditions: $V_{i\ min} - V_{i\ max}$, $I_o \leq I_{o\ nom}$, $V_{inh} \leq 0.8\ V$

LED "i" versus V_{i inh}
Conditions: $V_{i\ min} - V_{i\ max}$, $I_o \leq I_{o\ nom}$, $T_C \leq T_{C\ max}$

Fig.8
LED indicators

Electromagnetic Compatibility (EMC)

The **converters** and populated **subrack systems** successfully been tested to the following specifications:

Immunity

Table 7: Electromagnetic immunity (type tests)

Phenomenon	Standard	Level	Coupling mode ¹	Value applied	Waveform	Source imped.	Test procedure	In oper.	Perf. crit. ²
Electrostatic discharge (to case)	IEC/EN 61000-4-2	4	contact discharge	8000 V _p	1/50 ns	330 W 150 pF	10 positive and 10 negative discharges	yes	A
			air discharge	15000 V _p					
Electromagnetic field / Radiated susceptibility	IEC/EN 61000-4-3	3	antenna	20 V/m	AM 80%, 1 kHz	N/A	80 MHz – 1 GHz	yes	A
				10 V/m			1.4 – 2.1 GHz		
				5 V/m			2.1 – 2.5 GHz		
Electrical fast transients/burst	IEC/EN 61000-4-4	3	capacitive, o/c	±2000 V _p	bursts of 5/50 ns 2.5/5 kHz over 15 ms; burst period: 300 ms	50 Ω	60 s positive 60 s negative transients per coupling mode	yes	A
			±i/c, +i/-i direct						
Surges	IEC/EN 61000-4-5	3	±i/c	±2000 V _p	1.2/50 μs	12 Ω	5 pos. & 5 neg. surges per coupling mode	yes	A
			+i/-i			2 Ω			
Conducted disturbances	IEC/EN 61000-4-6	3	i, o, signal wires	10 VAC (140 dBμV)	AM 80% 1 kHz	150 Ω	0.15 – 80 MHz sine wave	yes	A

¹ i = input, o = output, c = case

² A = Normal operation, no deviation from specifications, B = Temporary loss of function or deviation from specs.

Emissions

For conducted emissions, the **converters** comply with class A according to EN 55022 and FCC Part 15.

For radiated emissions, the converters comply with class A according to EN 55022 and FCC Part 15 (30 MHz – 10 GHz).

The populated subrack systems have been tested for conducted and radiated emissions; see fig. 9 and fig. 10.

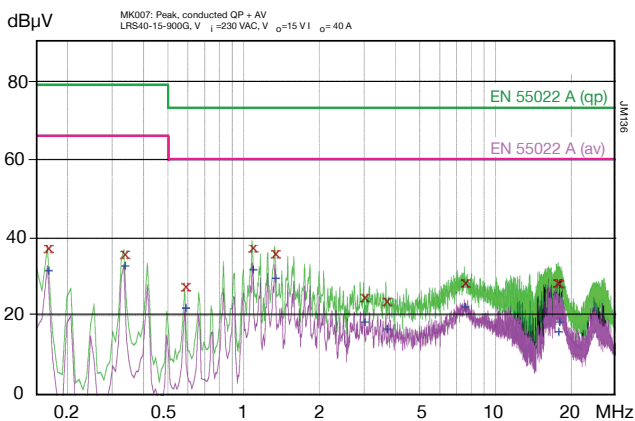

Fig. 9
Conducted emissions peak and average at the input (populated subrack system LRS40-15-900G at $V_{in} = 230$ VAC, $V_o = 15$ V, $I_o = 40$ A)

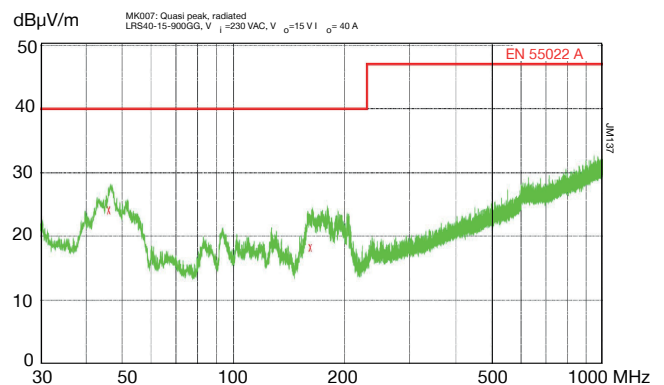

Fig. 10
Radiated emissions quasi peak, antenna distance 10 m (populated subrack system LRS40-15-900G at $V_{in} = 230$ VAC, $V_o = 15$ V, $I_o = 40$ A)

Immunity to Environmental Conditions

The populated subrack system has been tested as per table 8.

Table 8: Mechanical and climatic stress for a populated rack

Test method		Standard	Test Conditions	Status
Cab	Damp heat steady state	IEC/EN 60068-2-78:2001 MIL-STD-810D section 507.2	Temperature: 40 ±2 °C	System incl. converters not operating
			Relative humidity: 93 +2/-3 %	
			Duration: 56 days	
Kb	Salt mist, cyclic (sodium chloride NaCl solution)	IEC/EN 60068-2-52:1996	Concentration: 5% (30 °C) for 2 h per cycle	System incl. converters not operating
			Storage: 40°C, 93% rel. humidity for	
			Duration: 3 cycles of 22 h	
Fc	Vibration (sinusoidal)	AREMA Part. 11.5.1 class B (wayside outdoors)	Acceleration amplitude: 2.54 mm (5 – 20 Hz) 2 g _n = 19.6 m/s ² (20 – 200 Hz)	System incl. converters operating
			Frequency (0.9 Oct/min): 5 – 200 Hz	
			Test duration: 12 h (4 h in each axis)	
Ea	Shock (half-sinusoidal)	AREMA Part. 11.5.1 class B (wayside outdoors)	Acceleration amplitude: 10 g _n = 98 m/s ²	System incl. converters operating
			Bump duration: 11 ms	
			Number of bumps: 18 (3 in each direction)	

The converters have been tested separately to more severe limits and with more tests. For details, see K Series Data Sheet on our web site (BCD20001-G).

Temperatures

Table 9: Temperature specifications

Temperature characteristics		Conditions	-9			Unit
			min	typ	max	
T _A	Ambient temperature ¹	Converter operating	-40		+71 ¹	°C
T _C	Case temperature ²		-40		+95 ²	
T _S	Storage temperature	Non operational	-55		+95 ²	

¹ For converters and the systems

² For converters. Overtemperature lockout at T_C >95 °C

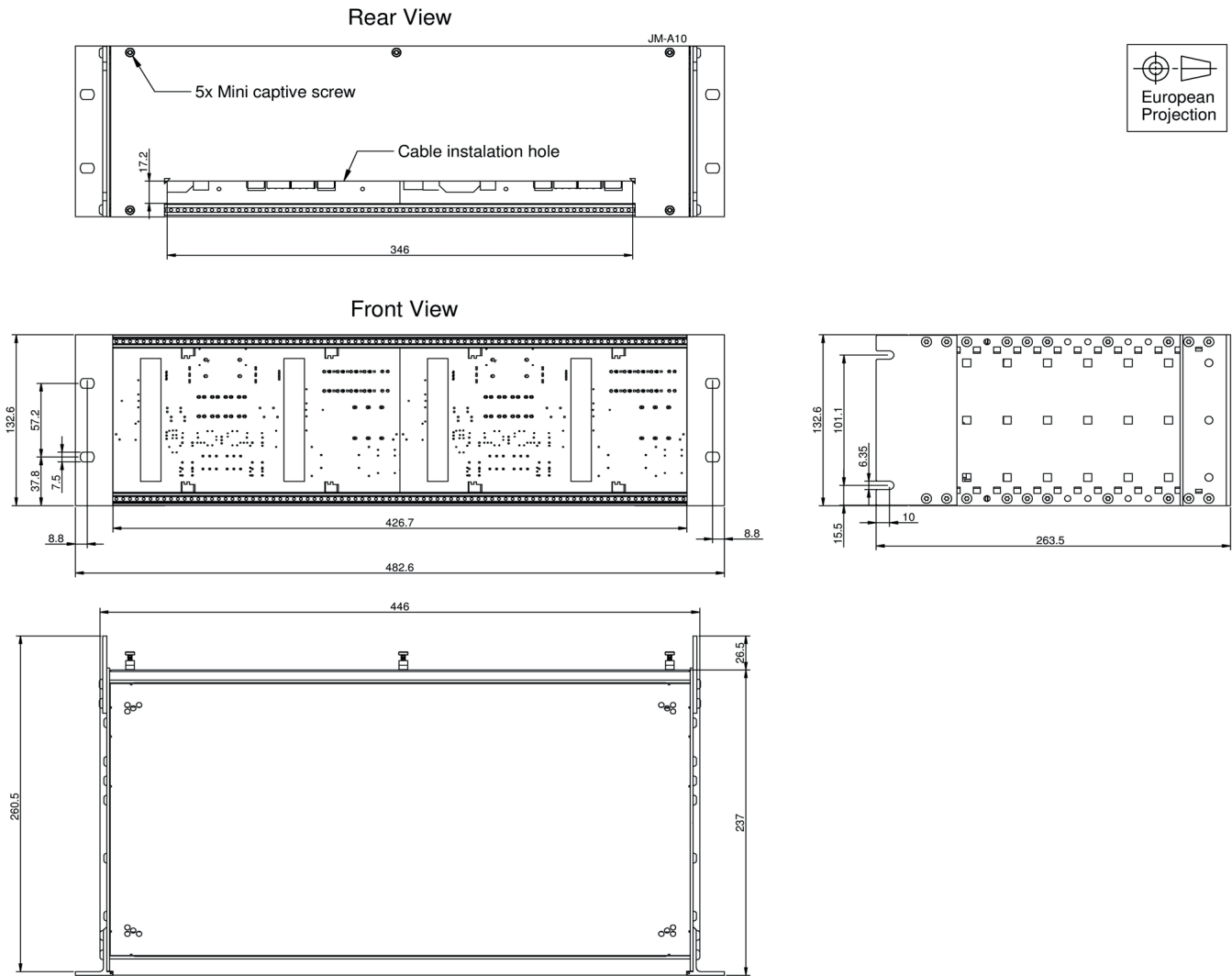

Fig. 12
19" rack MK007-001G, dimensions in mm.
Weight approx. 2.8 kg (empty)

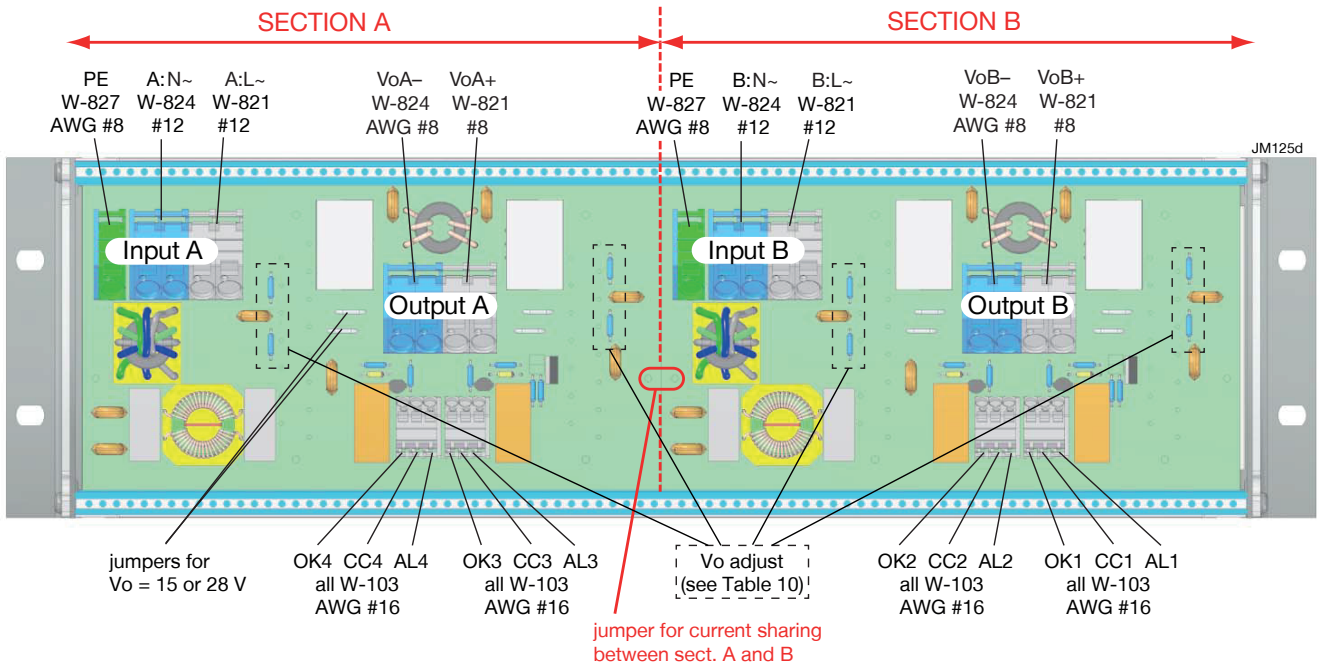

Fig. 13a: Rear view and connections of single output system.
“W-” stands for “WAGO 745-”. Recommended cable cross sections; see Table 11 for min / max cross sections.

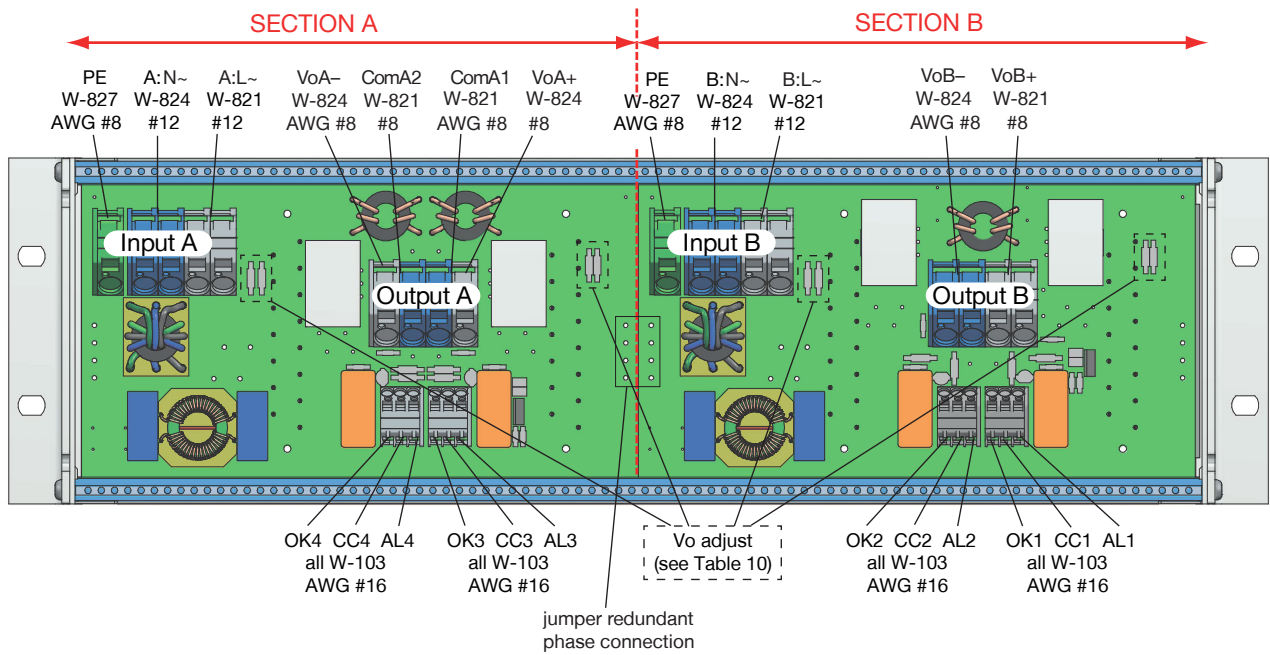

Fig. 13b: Rear view and connections of dual output system.
“W-” stands for “WAGO 745-”. Recommended cable cross sections; see Table 11 for min / max cross sections.

Table 10: Allocation of resistors for output voltage adjustment

Designation	Function
R3 / R9 / Vo+ / Rinc	Increasing output voltage
R4 / R10 / Vo- / Rdec	Decreasing output voltage

Safety and Installation Instructions

Please read the Installation Instruction **BCM.00071**.

Table 11: Cross sections

Position	WAGO reference	Cross section		
		min	recom	max
Input / Output	745-851, 745-854	24 AWG	12 AWG	6 AWG
PE 	745-857	24 AWG	8 AWG	6 AWG
Alarm signals	745-857	24 AWG	16 AWG	12 AWG

Connector Pin Allocation of the Converters

The connector pin allocation table defines the electrical potentials and the physical pin positions on the H15 connector.

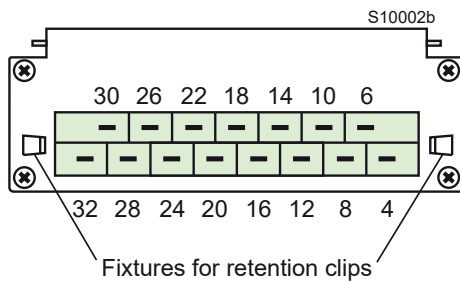



Fig. 14
View of converter's male connector, type H15

Table 12: Pin allocation of the converter

Pin	LK5542, LK5662	
4, 6	Vo2+	Pos. output 2
8, 10	Vo2-	Neg. output 2
12	Vo1+	Pos. output 1
14	Vo1-	Neg. output 1
16	R	Control of V_{o1}
18	i	Inhibit
20	D	Save data
22	T	Current share
24 ¹		Protective earth PE
26, 28	N~	Neutral line
30, 32	L~	Phase line

¹ Leading pin (pre-connecting)

The protective earth is connected by a leading pin (no. 24), ensuring that it makes contact with the female connector first.

Standards and Approvals

The **converters** correspond to Class I equipment and are safety-approved to the latest edition of EN/IEC 60950-1 and UL/CSA 60950-1. For more details see the special data sheets of LK5442 and LK5662 and the LK PFC Series on our web site.

All products are subject to manufacturing surveillance in accordance with the above mentioned standards and with ISO 9001:2015, IRIS ISO/TS 22163:2017 certified quality and business management system.

Leakage Currents per Converter

Leakage currents flow due to internal leakage capacitances and Y-caps. The current values are proportional to the voltage and frequency of the supply. They are specified in the Table 13.

Table 13: Leakage currents per converter

Characteristics		Class I	Unit
Maximum earth leakage	Permissible according to IEC/EN 60950	3.5	mA
	Typ. value at 115 V, 60 Hz; per converter	0.4	
	Typ. value at 230 V, 50 Hz; per converter	0.7	

Protective Lacquer

All boards of the converters are coated with a protective lacquer. The rack including the back plane is designed with higher creepage distances and clearances, but is not protected by lacquer.

Isolation and Safety Test

The electric strength test of the converters is performed in the factory as routine test in accordance with EN 50514 and IEC/EN 60950. The racks are tested without converters, but with all relays and signalling circuits.

Table 14 is valid for the racks populated with converters.

Table 14: Isolation (including converters which are separately tested)

Characteristics		Input to case and output(s)	Output(s) to case and input	Output 1 to output 2	Alarm signals to everything	Unit
Electric strength test	Factory test 1 to 6 s	2.8 ¹	4.3	0.18	4.3	kVDC
	AC test voltage equivalent to factory test	2.0	3.0	0.12	3.0	kVAC
Insulation resistance at 500 VDC		>300	>100 ²	--	--	MΩ
Creepage distances	converters	≥ 3.2 ³	≥ 4.5	--	--	mm
	racks	≥ 6.4	≥ 6.4	--	≥ 6.4	

¹ According to EN 50116 and IEC/EN 60950, subassemblies (of converters and rack) connecting input to output, e.g. transformers, opto couplers, relays, etc.) are pre-tested with 5.6 kVDC or 4 kVAC.

² Tested with 150 VDC

³ Input to outputs: 6.4 mm

Battery Charging / Temperature Sensor

All converters with an R-input are suitable for battery charger applications

For optimal battery charging and life expectancy of the battery, an external temperature sensor can be connected with the R-input. The sensor is mounted as close as possible to the battery and adjusts the output voltage according to the battery temperature.

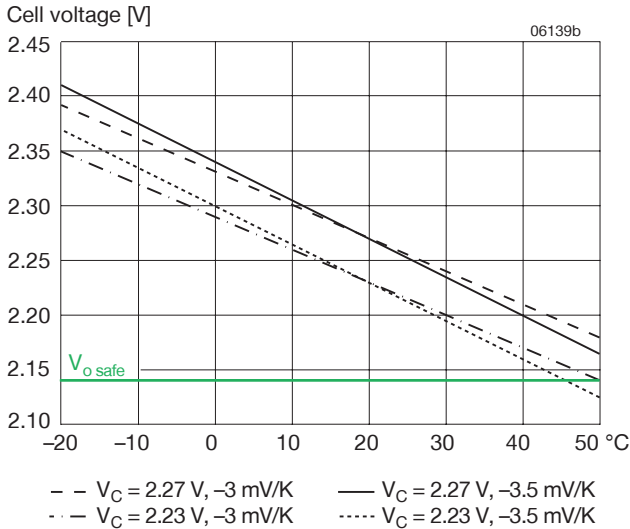

Fig. 15
Trickle charge voltage versus temperature for defined temperature coefficient.

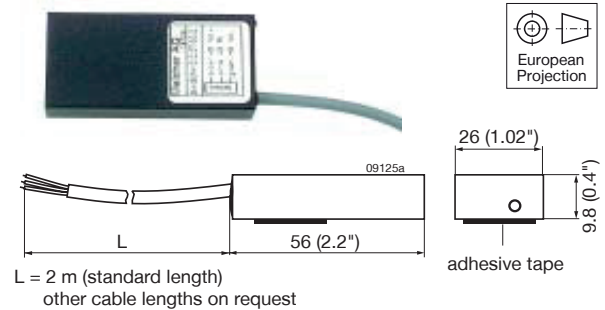

Fig. 16
Mechanical data of a temperature sensor

Depending upon cell voltage and the temperature coefficient of the battery, different sensor types are available (other models on request):

Table 15: Sensors for converters LK5542 and LK5662

Battery voltage nom. [V]	Sensor type	Cell voltage [V]	Cell temp. coefficient [mV/K]	Cable length [m]
12	S-KSMH12-2.27-30-2	2.27	-3.0	2
12	S-KSMH12-2.27-35-2	2.27	-3.5	2
24	S-KSMH24-2.27-30-2	2.27	-3.0	2
24	S-KSMH24-2.27-35-2	2.27	-3.5	2
24	S-KSMH24-2.31-35-0	2.31	-3.5	4.5
24	S-KSMH24-2.31-35-2	2.31	-3.5	2
24	S-KSMH24-2.35-35-2	2.35	-3.5	2
48	S-KSMH48-2.27-30-2	2.27	-3.0	2
48	S-KSMH48-2.27-35-2	2.27	-3.5	2

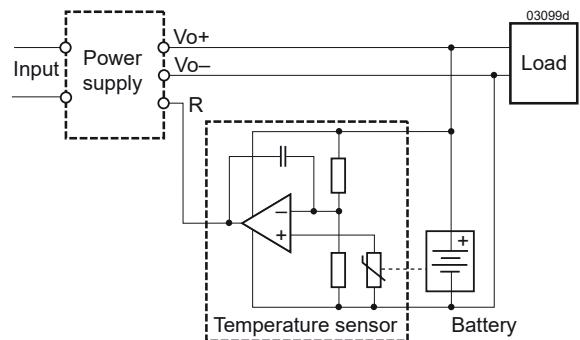

Fig. 17
Connection of a temperature sensor

NUCLEAR AND MEDICAL APPLICATIONS - These products are not designed or intended for use as critical components in life support systems, equipment used in hazardous environments, or nuclear control systems.

TECHNICAL REVISIONS - The appearance of products, including safety agency certifications pictured on labels, may change depending on the date manufactured. Specifications are subject to change without notice.

Компания «Life Electronics» занимается поставками электронных компонентов импортного и отечественного производства от производителей и со складов крупных дистрибьюторов Европы, Америки и Азии.

С конца 2013 года компания активно расширяет линейку поставок компонентов по направлению коаксиальный кабель, кварцевые генераторы и конденсаторы (керамические, пленочные, электролитические), за счёт заключения дистрибьюторских договоров

Мы предлагаем:

- Конкурентоспособные цены и скидки постоянным клиентам.
- Специальные условия для постоянных клиентов.
- Подбор аналогов.
- Поставку компонентов в любых объемах, удовлетворяющих вашим потребностям.
- Приемлемые сроки поставки, возможна ускоренная поставка.
- Доставку товара в любую точку России и стран СНГ.
- Комплексную поставку.
- Работу по проектам и поставку образцов.
- Формирование склада под заказчика.
- Сертификаты соответствия на поставляемую продукцию (по желанию клиента).
- Тестирование поставляемой продукции.
- Поставку компонентов, требующих военную и космическую приемку.
- Входной контроль качества.
- Наличие сертификата ISO.

В составе нашей компании организован Конструкторский отдел, призванный помогать разработчикам, и инженерам.

Конструкторский отдел помогает осуществить:

- Регистрацию проекта у производителя компонентов.
- Техническую поддержку проекта.
- Защиту от снятия компонента с производства.
- Оценку стоимости проекта по компонентам.
- Изготовление тестовой платы монтаж и пусконаладочные работы.



Тел: +7 (812) 336 43 04 (многоканальный)

Email: org@lifeelectronics.ru