

# IEC and British Standard Fuses

## Section Contents

|  | Page           |
|--|----------------|
| <b>Application Data</b> . . . . .  | <b>217-218</b> |
| CSA Type P and Type D fuses<br>(CDS, CDN & PON) . . . . .  | .219           |
| Tron® HRC Form II Class C fuses<br>(CGL Form II Class C) . . . . .   | 220            |
| HRCI Industrial ceramic body fuses (CIF21 HRCI-CA &<br>CIF06 HRCI-CB) . . . . .  | 221            |
| HRCI-J Fast-acting fuses (CJ HRCI-J) . . . . .   | 222            |
| HRCI-Miscellaneous Type K fuses (CIH, CIK &<br>CIL HRCI-MISC) . . . . .  | 223            |
| HRC Form II current-limiting fuses . . . . .   | .224           |
| BS 88 British Standard low voltage fuses (SSD, NSD,<br>ESD & STD, NITD, AAO, BAO, OSD, CEO,<br>DEO BS 88 Part 1) . . . . . | .225           |
| BS 88 British Standard low voltage fuses (AC, AD, BC,<br>BD, CD, DD, ED, EFS & EF, FF, FG, GF, GG,<br>GH BS 88) . . . . .  | .226           |
| DIN Style Type D (D16, D27, D33, D125 Type D) . . . . .  | 227            |
| Neozed low voltage fuses (NZ01, NZ02 Type D0) . . . . .  | 227            |
| NH HRC Fuses . . . . .   | <b>228-231</b> |
| Class gG/gL IEC Industrial ferrule fuses (C08G, C08M,<br>C10G, C10M, C14G, C14M, C22G, C22M) . . . . .                     | <b>232</b>     |
| Class aM IEC Industrial ferrule fuses (C08M, C10M,<br>C14M, C22M) . . . . .  | <b>233</b>     |
| Class aM & gG/gL IEC Industrial ferrule fuses with striker<br>(C14G_S, C22G_S, C14M_S, C22M_S) . . . . .                   | 234            |
| <b>HRC fuse holders</b>  |                |
| CAMaster . . . . .   | .235           |
| SAFEloc . . . . .  | .235           |

**RED indicates NEW information**



## Application Data

The standard range of fuses for low voltage industrial and general purpose applications meet the requirements of BS 88 and IEC 60269. By using advanced fuse technology, current ratings up to 400A have compact dimensions, but retain standard dimensional and performance requirements. These designs are for 315/240V systems. The standard range of fuses are available from 2-1250A in the following tag forms: Offset Blade - Offset Bolted - Center Bolted.

Supplementary ranges cover applications up to 660Vac and 500Vdc including those with nonstandard tag fixings.

Cooper Bussmann fuses are manufactured under quality systems independently assessed to BS 5750 (ISO 9002) and appropriate ratings carry the ASTA 20 endorsement.

Selecting fuses is relatively simple and effective. The following notes cover the majority of applications. For further information contact our Application Engineers at 636-527-1270.

### Circuit Loading

The current rating of the fuse should not be less than the full load current of the circuit. The circuit should be so designed that small overloads of long duration will not be of frequent occurrence.

### Cable Ratings & Protection

There is an increasing move away from 70°C PVC insulation to materials that are more environmentally friendly, for example 90°C XLPE. The ratings of fusegear, switches, accessories, etc. are generally based upon the equipment being connected to conductors intended to be operated at a temperature not exceeding 70°C in normal service.

In view of the above, it is recommended that the practice of designs based upon conductor temperatures of 70°C be regarded as the norm. The equipment manufacturer should be consulted to ascertain the reduction of nominal current rating of the equipment if conductor temperatures exceeding 70°C are used. In addition, an overriding factor is often voltage drop.

Fuses with gG characteristics protect associated cables against both overload and short-circuit current, provided that the current rating of the fuse 1N is equal or less than the current carrying capacity of the cable 1z.

In motor circuits, the motor starter will provide the overload protection and the fuses will provide the short-circuit protection. The maximum fuse size that can be used depends upon the type of cable used and is determined using the appropriate K factor. The following table gives the maximum sizes of fuses that are recommended for two popular cables with copper conductors, 70°C PVC (K = 115) and 90°C thermosetting (K = 143).

## Application Data for BS Low Voltage Fuses

| Cable Size (mm <sup>2</sup> ) | Max. Fuse Rating (amps) |         |
|-------------------------------|-------------------------|---------|
|                               | K = 115                 | K = 143 |
| 1                             | 16                      | 16      |
| 1.5                           | 20                      | 25*     |
| 2.5                           | 32*                     | 32*     |
| 4                             | 50*                     | 50*     |
| 6                             | 63*                     | 63*     |
| 10                            | 100*                    | 125*    |
| 16                            | 125*                    | 160*    |
| 25                            | 200*                    | 250*    |
| 35                            | 315*                    | 355*    |
| 50                            | 400*                    | 500     |
| 70                            | 560                     | 630     |
| 95                            | 710                     | 800     |
| 120                           | 800                     | 1000    |

\* Extended Motor Circuit dual ratings can be used.

### Protection Against Electrical Shock

For a TN System, a disconnecting time not exceeding 5s is permitted for a distribution circuit. The maximum values of earth fault loop impedance (Zs) of 240V for Cooper Bussmann gG fuses to BS 88: Parts 2 and 6 are:

| Rating (A) | Zs (Ohms) | Rating (A) | Zs (Ohms) | Rating (A) | Zs (Ohms) |
|------------|-----------|------------|-----------|------------|-----------|
| 6          | 14        | 50         | 1.1       | 250        | 0.16      |
| 10         | 7.7       | 63         | 0.86      | 315        | 0.13      |
| 16         | 4.3       | 80         | 0.60      | 400        | 0.096     |
| 20         | 3.0       | 100        | 0.44      | 500        | 0.073     |
| 25         | 2.4       | 125        | 0.35      | 630        | 0.054     |
| 32         | 1.9       | 160        | 0.27      | 800        | 0.044     |
| 40         | 1.4       | 200        | 0.20      |            |           |

### Ambient Temperature

The derating, in terms of current, of 0.5% per °C above an ambient of 35°C is recommended.

### Interrupting Rating

The standardized interrupting rating values are 80kA for voltages of 415Vac and above, and 40kA for DC applications. The 240Vac designs have an interrupting rating of 50kA.

### Coordination Ratio

All fuses to BS 88 Parts 2 and 6 will give a coordination ratio of 2:1; and for most practical situations a ratio of 1.6:1 (two steps in the R10 series). Example: an upstream fuse rated at 160A will coordinate with a downstream fuse rated at 100A.

### Current and Energy Limitation

The range of fuses have pre-arcing I<sup>2</sup>t values towards the bottom limits of BS 88 Parts 2 and 6. This ensures excellent current and energy limitation. They also have lower power losses at rated current. This assists in the appropriate interchangeability with other makes of fuses.

### Transformers

When fuses are used on the primary side of transformers, the normal fuse current rating should be at least twice the nominal transformer primary current.

### Fluorescent Lighting

The normal fuse current rating should be at least twice the normal full load current of the maximum number of lights to be simultaneously switched.

### Capacitor Circuits

For power factor correction in capacitor circuits, the fuse should be chosen with a current rating greater than 1.5 times the rated capacitor current. This takes into account the high inrush current, circuit harmonics and capacitor tolerances.

### Motor Circuits

In motor circuits, the fuse has to withstand the motor's starting current and often requires a higher rating than the motor's full load current. Coordination recommendations are made by the manufacturers of motor starters in accordance with IEC 60947-4-1. To get Type 2 coordination with fuses, tests are performed with the latest gG or gM fuses to BS 88 or IEC 60269 that have pre-arcing I<sup>2</sup>t values towards the bottom of specified limits. This means that Cooper Bussmann fuses are suitable to provide Type 2 coordination.

Extended dual ratings of motor circuit protection fuses with gM characteristics are available in most popular fuse sizes to extend the use of associated equipment with appropriate economies. In the majority of applications, gG fuses are used. It is not essential to use gM fuses for motor circuit protection, they simply extend the utilization of standard equipment.

Below is a table of recommended fuses at 415V. In most applications, the run-up time is less than 5 seconds and duty is infrequent - no more than twice per hour. The next larger rating should be used for more demanding applications.

| Rating Motor |       | Direct On-line |                    | Asst. Start Standard (gG) |
|--------------|-------|----------------|--------------------|---------------------------|
|              |       | Standard (gG)  | Motor Circuit (gM) |                           |
| kW           | A     | A              | A                  | A                         |
| 0.25         | 0.8   | 4              | -                  | 2                         |
| 0.37         | 1.1   | 4              | -                  | 2                         |
| 0.55         | 1.5   | 6              | -                  | 4                         |
| 0.75         | 2.0   | 6              | -                  | 4                         |
| 1.1          | 3.0   | 10             | -                  | 6                         |
| 1.5          | 3.6   | 16             | -                  | 0 1                       |
| 2.2          | 5.0   | 16             | -                  | 0 1                       |
| 3.0          | 6.5   | 20             | -                  | 6 1                       |
| 4.0          | 8.4   | 20             | -                  | 6 1                       |
| 5.5          | 11.0  | 25             | 20M25              | 2 20                      |
| 7.5          | 15.0  | 40             | 32M40              | 25                        |
| 11.0         | 20.0  | 50             | 32M50              | 32                        |
| 15.0         | 27.0  | 63             | 32M63              | 40                        |
| 18.5         | 33.0  | 80             | 63M80              | 50                        |
| 22.0         | 38.0  | 80             | 63M80              | 50                        |
| 30.0         | 54.0  | 100            | 63M100             | 80                        |
| 37.0         | 66.0  | 125            | 100M125            | 80                        |
| 45.0         | 79.0  | 160            | 100M160            | 100                       |
| 55.0         | 98.0  | 160            | 100M160            | 100                       |
| 75.0         | 135.0 | 250            | 200M250            | 160                       |
| 90.0         | 155.0 | 250            | 200M250            | 160                       |
| 110.0        | 185.0 | 315            | 200M315            | 200                       |
| 132.0        | 220.0 | 355            | 315M400            | 250                       |
| 150.0        | 250.0 | 355            | 315M400            | 315                       |
| 185.0        | 310.0 | 450            | 400M500            | 355                       |
| 200.0        | 335.0 | 500            | 4 00M500           | 400                       |
| 225.0        | 375.0 | 560            | -                  | 400                       |
| 250.0        | 415.0 | 560            | -                  | 450                       |
| 280.0        | 460.0 | 630            | -                  | 500                       |
| 335.0        | 562.0 | 710            | -                  | 630                       |
| 355.0        | 596.0 | 800            | -                  | 710                       |

## CSA Type P and Type D Fuses

### CDS, CDN & PON Type P & D

#### Specifications

**Description:** CSA time-delay Type D & P fuses.

**Dimensions:** See Catalog Numbers table and Dimensions illustration.

#### Ratings:

Volts: — 250Vac (CDN & PON)  
— 600Vac (CDS)

Amps: — 10-600A

IR: — 10kA minimum

**Agency Information:** CE, CSA Certified to C22.2 No. 59.1.

#### Features and Benefits

- Economical fuse in a variety of ratings for applications not requiring time-delay.

#### Typical Applications

- Lighting, heating and other circuits not subject to temporary surges and where available short-circuit current are relatively low.

#### Basic Catalog Numbers

##### Time-Delay CSA Type "D" Fuses

| Catalog Numbers | Volts  | Amp Ratings  |
|-----------------|--------|--|
| CDN             | 250Vac | Below 10A use FRN-R 10, 12, 15, 20, 25, 30, 35, 40, 45, 50, 60, 70, 80, 90, 100  |
|                 |        | 110, 125, 150, 175, 200, 225, 250, 300, 350, 400, 450, 500, 600                  |
|                 |        | Below 10A use FRS-R 10, 12, 15, 20, 25, 30, 35, 40, 45, 50, 60                   |
|                 |        | 70, 80, 90, 100, 110, 125, 150, 175, 200, 225, 250, 300, 350, 400, 450, 500, 600 |
|                 |        | 225, 250, 300, 350, 400, 450, 500, 600   |
| CDS             | 600Vac | 70, 80, 90, 100, 110, 125, 150, 175, 200, 225, 250, 300, 350, 400, 450, 500, 600 |

##### One-Time CSA Type "P" Fuses

| Catalog Number | Volts  | Amp Ratings                        |
|----------------|--------|------------------------------------|
| PON            | 250Vac | 15, 20, 25, 30, 35, 40, 45, 50, 60 |



#### Dimensions



Ferrule Design—1 through 60A



Knife Blade—70 through 600A

IEC & British Fuses

### Catalog Numbers

| Basic Catalog Number and Volts | Dimensions in (mm) |               |                |                    |                     |                   |               |
|--------------------------------|--------------------|---------------|----------------|--------------------|---------------------|-------------------|---------------|
|                                | Amp Ratings        | A Overall     | B Max Diameter | C Min Blade Length | D Min Barrel Length | E Blade Thickness | F Blade Width |
| CDN/PON 250Vac                 | 1-30               | 2.0 (50.8)    | 0.56 (14.3)    | —                  | —                   | —                 | —             |
|                                | 35-60              | 3.0 (76.2)    | 0.81 (20.6)    | —                  | —                   | —                 | —             |
|                                | 70-100             | 5.88 (149.4)  | —              | 1.0 (25.4)         | —                   | 0.13 (3.2)        | 0.75 (19.1)   |
|                                | 110-200            | 7.3 (185.4)   | —              | 1.38 (34.9)        | 4.13 (104.8)        | 0.19 (4.8)        | 1.13 (28.6)   |
|                                | 225-400            | 8.63 (219.2)  | —              | 1.88 (47.6)        | 4.63 (117.5)        | 0.25 (6.4)        | 1.63 (41.3)   |
| CDS 600Vac                     | 450-600            | 10.38 (263.7) | —              | 2.25 (57.2)        | 5.19 (131.8)        | 0.25 (6.4)        | 2 (50.8)      |
|                                | 1-30               | 5.0 (127.0)   | 0.81 (20.6)    | —                  | —                   | —                 | —             |
|                                | 35-60              | 5.5 (139.7)   | 1.06 (27.0)    | —                  | —                   | —                 | —             |
|                                | 70-100             | 7.88 (200.2)  | —              | 1.0 (25.4)         | —                   | 0.13 (3.2)        | 0.75 (19.1)   |
|                                | 110-200            | 9.63 (244.6)  | —              | 1.38 (34.9)        | 6.13 (115.6)        | 0.19 (4.8)        | 1.13 (28.6)   |
|                                | 225-400            | 11.63 (295.4) | —              | 1.88 (47.6)        | 7.13 (118.1)        | 0.25 (6.4)        | 1.63 (41.3)   |
| 450-600                        | 13.38 (339.9)      | —             | 2.25 (57.2)    | 8.19 (208.0)       | 0.25 (6.4)          | 2 (50.8)          |               |

#### To Order

To order, specify Basic Catalog Number and amp rating. Example: CDN-30

Data Sheet: 4126

# Tron® HRC Form II Class C Fuses

## CGL Form II Class C

### Specifications

**Description:** Current-limiting HRCII-C fuses designed to withstand inrush currents on typical motor start-ups while offering high current limitation in the short-circuit region.

**Dimensions:** See Dimensions illustrations.

### Ratings:

Volts: — 600Vac/250Vdc (1-30A)

Amps: — 1-600A

IR: — 200kA (40,000A DC)

**Agency Information:** CE, CSA Certified, C22.2 No. 106.

### Features and Benefits

- Close sizing to loads allows using smaller and less costly switches
- Provides a higher degree of short-circuit protection
- Helps protect motors against burnout from overloads

### Typical Applications

- For use in circuits subject to surge currents such as those caused by motors, transformers and other inductive loads

### Catalog Numbers (-Amps)

|        |         |         |
|--------|---------|---------|
| CGL-1  | CGL-40  | CGL-175 |
| CGL-2  | CGL-45  | CGL-200 |
| CGL-3  | CGL-50  | CGL-225 |
| CGL-4  | CGL-60  | CGL-250 |
| CGL-6  | CGL-70  | CGL-300 |
| CGL-10 | CGL-80  | CGL-350 |
| CGL-15 | CGL-90  | CGL-400 |
| CGL-20 | CGL-100 | CGL-450 |
| CGL-25 | CGL-110 | CGL-500 |
| CGL-30 | CGL-125 | CGL-600 |
| CGL-35 | CGL-150 |         |



### Dimensions

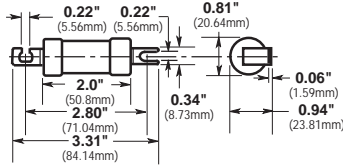

CGL 1-30

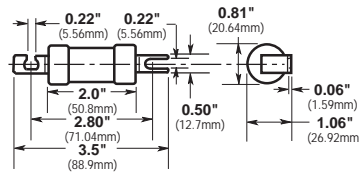

CGL 35-60

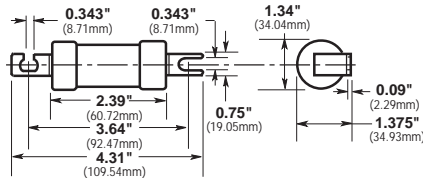

CGL 70-100

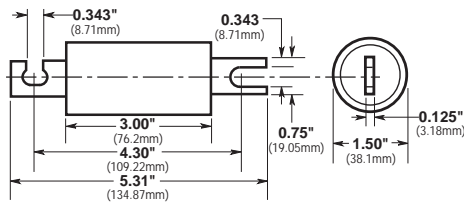

CGL 110-200

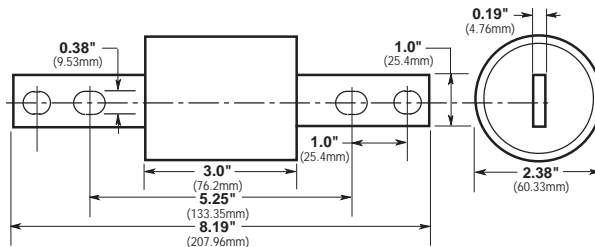

CGL 225-400

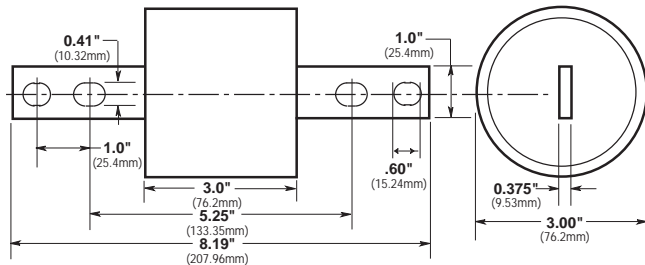

CGL 450-600

## HRCI Industrial Ceramic Body Fuses

### CIF21 HRCI-CA

#### Specifications

**Description:** The HRCI-CA fuse provides both overload and short-circuit protection to HRCI requirements. Offset blades for bolt-on mounting. CIF21 fuse fits the Cooper Bussmann CAMaster fuse holder (see data sheet 4132).

**Dimensions:** See Dimensions illustration.

**Construction:** Ceramic body.

#### Ratings:

Volts: — 600Vac/250Vdc

Amps: — 1-30A

IR: — 200kA RMS Sym.

**Agency Information:** CE, CSA C22.2, No. 106-M92.

**Mounting:** Bolt-on.

#### Catalog Numbers

| Catalog Numbers | Amp Ratings |
|-----------------|-------------|
| 1CIF21          | 1           |
| 3CIF21          | 3           |
| 6CIF21          | 6           |
| 10CIF21         | 10          |
| 15CIF21         | 15          |
| 20CIF21         | 20          |
| 25CIF21         | 25          |
| 30CIF21         | 30          |

#### Features and Benefits

- Close sizing to loads allows using smaller and less costly switches
- Provides a higher degree of short-circuit protection
- Helps protect motors against burnout from overloads

#### Typical Applications

- For use in circuits subject to surge currents such as those caused by motors, transformers and other inductive loads

#### Dimensions - in (mm)

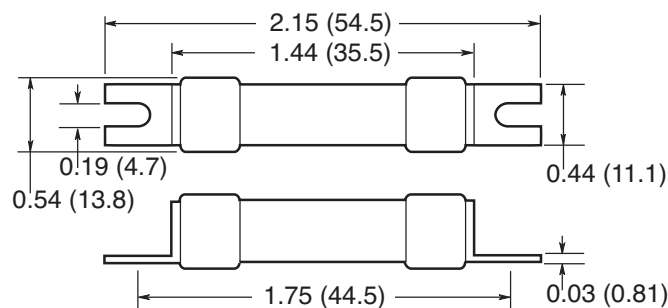

Data Sheet: 4127

### CIF06 HRCI-CB

#### Specifications

**Description:** A miniature industrial fuse that provides both short-circuit and overload protection and the CIF06 fits the 30A SAFEloc fuse holder.

**Dimensions:** See Dimensions illustration.

**Construction:** Ground ceramic body with plated end caps.

#### Ratings:

Volts: — 600Vac/250Vdc

Amps: — 1-30A

IR: — 200kA RMS Sym.

**Agency Information:** CE, CSA C22.2 No. 106-M92 (3-30A only).

**Mounting:** Clip-in offset blades.

#### Catalog Number

| Catalog Numbers | Amp Ratings |
|-----------------|-------------|
| 1CIF06          | 1           |
| 3CIF06          | 3           |
| 6CIF06          | 6           |
| 10CIF06         | 10          |
| 15CIF06         | 15          |
| 20CIF06         | 20          |
| 25CIF06         | 25          |
| 30CIF06         | 30          |

#### Features and Benefits

- Close sizing to loads allows using smaller and less costly switches
- Provides a higher degree of short-circuit protection
- Helps protect motors against burnout from overloads

#### Typical Applications

- For use in circuits subject to surge currents such as those caused by motors, transformers and other inductive loads

#### Dimensions - in (mm)

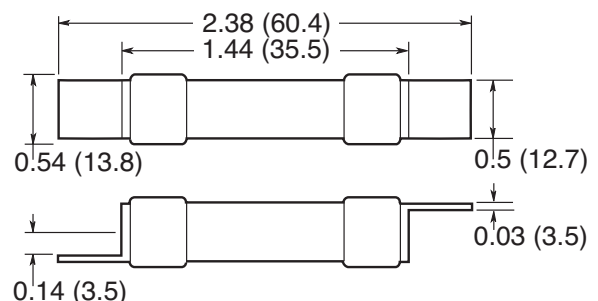

Data Sheet: 4128

# HRCI-J Fast-acting Fuses

## CJ HRCI-J

### Specifications

**Description:** HRCI-J fast-acting fuses are industrial duty fuses with the excellent current-limiting characteristics of fast-acting HRCI-J fuses to limit damage to equipment and installations by the thermal and magnetic energy associated with a large short-circuit fault current. Overload characteristics limit cable damage due to low overload currents.



**Dimensions:** See Catalog Numbers table and Dimensions illustrations.

**Construction:** Ceramic body fuse.

### Ratings:

Volts: — 600Vac (or less), 250Vdc

Amps: — 1-600A

IR: — 200kA

**Agency Information:** CSA C22.2 No. 106 M92; Designed to BS 88:2, IEC 60269-2.

### Dimensions

1CJ to 60CJ

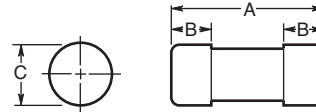

70CJ to 600CJ

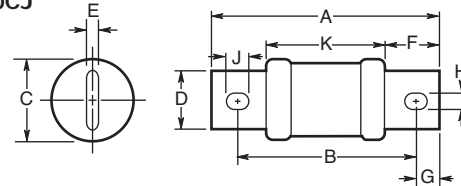

### Catalog Numbers

| Catalog Numbers | Amp Ratings | Dimensions in (mm) |            |             |             |            |             |             |             |             |           |
|-----------------|-------------|--------------------|------------|-------------|-------------|------------|-------------|-------------|-------------|-------------|-----------|
|                 |             | A                  | B          | C           | D           | E          | F           | G           | H           | J           | K         |
| 1CJ             | 1           |                    |            |             |             |            |             |             |             |             |           |
| 3CJ             | 3           |                    |            |             |             |            |             |             |             |             |           |
| 6CJ             | 6           |                    |            |             |             |            |             |             |             |             |           |
| 10CJ            | 10          |                    |            |             |             |            |             |             |             |             |           |
| 15CJ            | 15          | 2.25 (57)          | 0.5 (12.7) | 0.81 (20.6) | —           | —          | —           | —           | —           | —           | —         |
| 20CJ            | 20          |                    |            |             |             |            |             |             |             |             |           |
| 25CJ            | 25          |                    |            |             |             |            |             |             |             |             |           |
| 30CJ            | 30          |                    |            |             |             |            |             |             |             |             |           |
| 35CJ            | 35          |                    |            |             |             |            |             |             |             |             |           |
| 40CJ            | 40          |                    |            |             |             |            |             |             |             |             |           |
| 45CJ            | 45          | 2.38 (60)          | 0.63 (16)  | 1.06 (27)   | —           | —          | —           | —           | —           | —           | —         |
| 50CJ            | 50          |                    |            |             |             |            |             |             |             |             |           |
| 60CJ            | 60          |                    |            |             |             |            |             |             |             |             |           |
| 70CJ            | 70          |                    |            |             |             |            |             |             |             |             |           |
| 80CJ            | 80          | 4.63 (117)         | 3.63 (92)  | 1.13 (28)   | 0.75 (19)   | 0.13 (3.2) | 1 (25.4)    | 0.5 (12.7)  | 0.28 (7.1)  | 0.38 (9.5)  | 2.63 (67) |
| 90CJ            | 90          |                    |            |             |             |            |             |             |             |             |           |
| 100CJ           | 100         |                    |            |             |             |            |             |             |             |             |           |
| 110CJ           | 110         |                    |            |             |             |            |             |             |             |             |           |
| 125CJ           | 125         |                    |            |             |             |            |             |             |             |             |           |
| 150CJ           | 150         | 5.75 (146)         | 4.38 (111) | 1.63 (41)   | 1.13 (28.6) | 0.19 (4.8) | 1.38 (35)   | 0.69 (17.5) | 0.28 (7.1)  | 0.38 (9.5)  | 3 (76)    |
| 175CJ           | 175         |                    |            |             |             |            |             |             |             |             |           |
| 200CJ           | 200         |                    |            |             |             |            |             |             |             |             |           |
| 225CJ           | 225         |                    |            |             |             |            |             |             |             |             |           |
| 250CJ           | 250         |                    |            |             |             |            |             |             |             |             |           |
| 300CJ           | 300         | 7.13 (181)         | 5.25 (133) | 2.13 (54)   | 1.63 (41)   | 0.25 (6.3) | 1.88 (47.6) | 0.94 (24)   | 0.41 (10.3) | 0.53 (13.5) | 3.38 (86) |
| 350CJ           | 350         |                    |            |             |             |            |             |             |             |             |           |
| 400CJ           | 400         |                    |            |             |             |            |             |             |             |             |           |
| 450CJ           | 450         |                    |            |             |             |            |             |             |             |             |           |
| 500CJ           | 500         | 8 (203)            | 6 (152)    | 2.63 (66)   | 2 (51)      | 0.38 (9.5) | 2.13 (54)   | 1 (25.4)    | 0.53 (13.5) | 0.69 (17.5) | 3.75 (96) |
| 600CJ           | 600         |                    |            |             |             |            |             |             |             |             |           |

Data Sheet: 4129

# HRCI - Miscellaneous Type K Fuses

## CIH, CIK & CIL HRCI-MISC

### Specifications

**Description:** HRCI fuses provide both overload and short-circuit protection, featuring offset blades for bolt down mounting.

**Dimensions:** See Catalog Numbers table and Dimensions illustration.

**Construction:** Ceramic body.

### Ratings:

Volts: — 600V

Amps: — 1-100A

IR: — 200kA@600V

**Agency Information:** CE, CSA C22.2 No. 106 M92.



### Dimensions

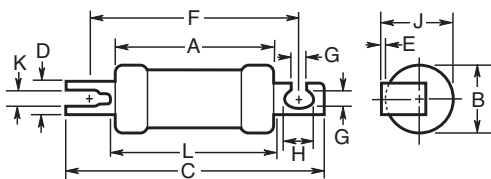

(The CIL14 has a rejection hole, not a slot as shown above.)

### Catalog Numbers

| Catalog Numbers | Amp Ratings | Dimensions: in (mm) |           |            |            |            |           |            |             |            |            |           |
|-----------------|-------------|---------------------|-----------|------------|------------|------------|-----------|------------|-------------|------------|------------|-----------|
|                 |             | A Max               | B Max     | C Max      | D Nom      | E Nom      | F Nom     | G Nom      | H Nom       | J Max      | K Nom      | L Max     |
| 1CIH07          | 1           | 2.25 (57)           | 0.94 (24) | 3.38 (86)  | 0.38 (9.2) | 0.04 (1.0) | 2.88 (73) | 0.21 (5.2) | 0.31 (8)    | 1 (25.4)   | 0.10 (2.6) | 2.38 (60) |
| 3CIH07          | 3           |                     |           |            |            |            |           |            |             |            |            |           |
| 6CIH07          | 6           |                     |           |            |            |            |           |            |             |            |            |           |
| 10CIH07         | 10          |                     |           |            |            |            |           |            |             |            |            |           |
| 15CIH07         | 15          |                     |           |            |            |            |           |            |             |            |            |           |
| 20CIH07         | 20          |                     |           |            |            |            |           |            |             |            |            |           |
| 25CIH07         | 25          |                     |           |            |            |            |           |            |             |            |            |           |
| 30CIH07         | 30          | 2.28 (58)           | 1.06 (27) | 3.56 (91)  | 0.5 (12.7) | 0.05 (1.2) | 2.88 (73) | 0.21 (5.2) | 0.41 (10.5) | 1.09 (28)  | 0.13 (3.2) | 2.38 (61) |
| 35CIK07         | 35          |                     |           |            |            |            |           |            |             |            |            |           |
| 40CIK07         | 40          |                     |           |            |            |            |           |            |             |            |            |           |
| 50CIK07         | 50          |                     |           |            |            |            |           |            |             |            |            |           |
| 60CIK07         | 60          | 2.75 (70)           | 1.44 (37) | 4.38 (111) | 0.75 (19)  | 0.09 (2.5) | 3.69 (94) | 0.34 (8.7) | 0.41 (10.5) | 1.5 (38.5) | —          | 2.91 (74) |
| 80CIL14         | 80          |                     |           |            |            |            |           |            |             |            |            |           |
| 90CIL14         | 90          |                     |           |            |            |            |           |            |             |            |            |           |
| 100CIL14        | 100         |                     |           |            |            |            |           |            |             |            |            |           |

### Recommended Fuse Holders

| Fuse   | Fuse Holder |
|--------|-------------|
| 1-30A  | CM30CF      |
| 35-60A | CM60CF      |

Data Sheet: 4130

# HRC Form II Current-limiting Fuses

## HRC Form II

### Specifications

**Description:** HRC Form II current-limiting fuses.

**Dimensions:** See Catalog Numbers table and Dimensions illustrations.

**Construction:** Ceramic body.

### Ratings:

Volts: — 600Vac (or less)  
— 250Vdc

Amps: — 2-600A

IR: — 200kA RMS Sym.

**Agency Information:** CE, CSA C22.2 No.106M1992;  
BS 88:2, IEC 60269:2.

### Typical Applications

- Used to protect motor control circuits, together with contactors and overload protection relays to provide Type 2 coordination - per IEC 60947-4.



### Dimensions

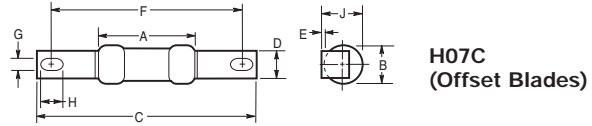

**H07C**  
(Offset Blades)

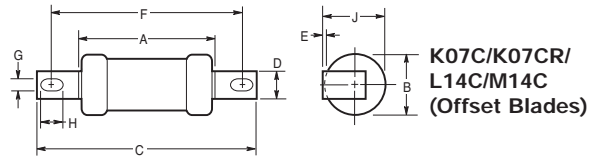

**K07C/K07CR/  
L14C/M14C**  
(Offset Blades)

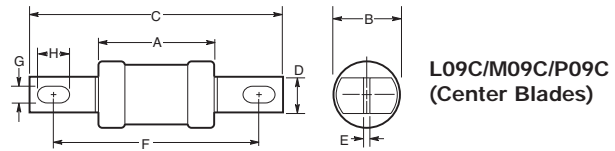

**L09C/M09C/P09C**  
(Center Blades)

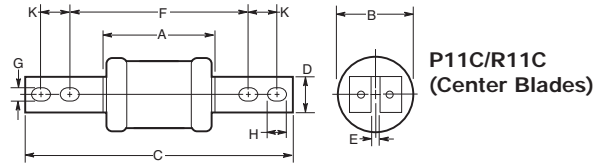

**P11C/R11C**  
(Center Blades)

### Catalog Numbers

| Catalog Numbers | Amp Ratings | Dimensions in (mm) |             |            |             |            |            |            |           |           |         | CSA Category |         |
|-----------------|-------------|--------------------|-------------|------------|-------------|------------|------------|------------|-----------|-----------|---------|--------------|---------|
|                 |             | A                  | B           | C          | D           | E          | F          | G          | H         | J         | K       |              |         |
| 2H07C           | 2           | 1.38 (35)          | 0.56 (14)   | 3.38 (85)  | 0.38 (9)    | 0.06 (1.2) | 2.88 (73)  | 0.22 (5.6) | 0.31 (8)  | 0.56 (14) | —       | HRCII-C      |         |
| 4H07C           | 4           |                    |             |            |             |            |            |            |           |           |         |              |         |
| 6H07C           | 6           |                    |             |            |             |            |            |            |           |           |         |              |         |
| 10H07C          | 10          |                    |             |            |             |            |            |            |           |           |         |              |         |
| 15H07C          | 15          |                    |             |            |             |            |            |            |           |           |         |              |         |
| 20H07C          | 20          |                    |             |            |             |            |            |            |           |           |         |              |         |
| 25H07C          | 25          |                    |             |            |             |            |            |            |           |           |         |              |         |
| 30H07C          | 30          | 2.19 (56)          | 0.88 (22)   | 3.44 (87)  | 0.5 (13)    | 0.13 (3.2) | 3.69 (94)  | 0.34 (8.7) | 0.88 (22) | —         | HRCII-C |              |         |
| 40K07C          | 40          |                    |             |            |             |            |            |            |           |           |         |              |         |
| 50K07C          | 50          |                    |             |            |             |            |            |            |           |           |         |              |         |
| 60K07C          | 60          | 2.38 (60)          | 0.88 (21.4) | 4.38 (111) | 0.56 (14.3) | 0.09 (2.4) | 4.38 (111) | 0.44 (11)  | —         | —         | HRCII-C |              |         |
| 80K07CR         | 80          |                    |             |            |             |            |            |            |           |           |         |              |         |
| 100K07CR        | 100         | 3.06 (178)         | 2.31 (59)   | 5.38 (136) | 0.56 (14)   | 0.13 (3.2) | 4.38 (111) | 0.34 (8.7) | 0.56 (14) | —         | —       | HRCII-C      |         |
| 80L14C          | 80          |                    |             |            |             |            |            |            |           |           |         |              |         |
| 100L14C         | 100         |                    |             |            |             |            |            |            |           |           |         |              |         |
| 125M14C         | 125         |                    |             |            |             |            |            |            |           |           |         |              |         |
| 150M14C         | 150         |                    |             |            |             |            |            |            |           |           |         |              |         |
| 200M14C         | 200         |                    |             | 0.19 (4.8) | 0.75 (19)   | 1 (25.4)   | 0.19 (5)   | 5.25 (133) | 0.41 (10) | 0.63 (16) | —       | —            | HRCII-C |
| 80L09C          | 80          |                    |             |            |             |            |            |            |           |           |         |              |         |
| 100L09C         | 100         |                    |             |            |             |            |            |            |           |           |         |              |         |
| 125M09C         | 125         |                    |             |            |             |            |            |            |           |           |         |              |         |
| 150M09C         | 150         |                    |             |            |             |            |            |            |           |           |         |              |         |
| 200M09C         | 200         | 3.19 (81)          | 2.88 (73)   | 8.25 (210) | 0.25 (6.3)  | 0.25 (6.3) | 0.41 (10)  | 0.63 (16)  | —         | 1 (25)    | HRCII-C |              |         |
| 250P09C         | 250         |                    |             |            |             |            |            |            |           |           |         |              |         |
| 300P09C         | 300         |                    |             |            |             |            |            |            |           |           |         |              |         |
| 350P09C         | 350         |                    |             |            |             |            |            |            |           |           |         |              |         |
| 400P09C         | 400         |                    |             |            |             |            |            |            |           |           |         |              |         |
| 250P11C         | 250         |                    |             |            |             |            |            |            |           |           |         |              |         |
| 300P11C         | 300         |                    |             |            |             |            |            |            |           |           |         |              |         |
| 350P11C         | 350         |                    |             |            |             |            |            |            |           |           |         |              |         |
| 400P11C         | 400         |                    |             |            |             |            |            |            |           |           |         |              |         |
| 450R11C         | 450         |                    |             |            |             |            |            |            |           |           |         |              |         |
| 500R11C         | 500         |                    |             |            |             |            |            |            |           |           |         |              |         |
| 600R11C         | 600         |                    |             |            |             |            |            |            |           |           |         |              |         |



## BS 88 British Standard Low Voltage Fuses

### SSD, NSD, ESD BS 88 Part 1

#### Specifications

**Description:** The NSD and ESD are low voltage fuses complying with general purpose gG characteristics.

**Construction:** Ceramic body.

#### Ratings:

Volts: — 240-550Vac (See Catalog Numbers table)

Amps: — 2-63A (See Catalog Numbers table)  
— 20M25-63M100A Motor Starter ratings (See Catalog Numbers table)

IR: — 33kA (SSD)  
— 80kA (NSD, ESD)

**Agency Information:** CE, Meets the requirements of BS 88 Part 1 and IEC 60269-1.

**Mounting:** Offset blades.

#### Basic Catalog Numbers

| Basic Catalog Numbers | Amp Ratings                             | Max AC Voltage Ratings | BS 88 Ref. |
|-----------------------|---|------------------------|------------|
| SSD                   | 2, 4, 6, 10, 16, 20, 25, 32             | 240                    | E1         |
| NSD                   | 2, 4, 6, 10, 16, 20, 25, 32,            | 550                    | F1         |
|                       | 20M25*, 20M32*, 20M36*, 32M36*, 32M40*, | 415                    | F1         |
|                       | 32M50*, 32M63*                          | 415                    | F1         |
| ESD                   | 2, 4, 6, 10, 16, 25, 32                 | 550                    | F2         |
|                       | 40, 50, 63, 63M80, 63M100*              | 415                    | F2         |

\*"M" indicates motor starter ratings.

#### To Order

To order, specify Basic Catalog Number and amp rating. Example: SSD-20

#### Recommended Fuse Holders

| Basic Fuse Catalog Numbers | Holder Catalog Numbers |
|----------------------------|------------------------|
| NSD                        | 32NNSF                 |
| ESD                        | 63ENSF                 |



### STD, NITD, AAO, BAO, OSD, CEO, DEO BS 88 Part 1

#### Specifications

**Description:** The STD to DEO types are low voltage fuses complying with general purpose gG characteristics.

**Construction:** Ceramic body.

#### Ratings:

Volts: — 240-550Vac (See Catalog Numbers table)

Amps: — 2-200A (See Catalog Numbers table)  
— 20M25-200M315A Motor Starter ratings (See Catalog Numbers table)

IR: — 33kA (STD)  
— 80kA (NITD, AAO, BAO, CEO, DEO)

**Agency Information:** CE, Meets the requirements of BS 88 Part 1 and IEC 60269-1.

**Mounting:** Offset bolted blades.

#### Typical Applications

- The STD type are used in 240V street lighting cut-outs.
- NITD to DEO types used for industrial and general purpose applications

#### Basic Catalog Numbers

| Basic Catalog Numbers | Amp Ratings   | Max AC Voltage Ratings | BS 88 Ref. |
|-----------------------|---|------------------------|------------|
| STD                   | 2, 4, 6, 10, 16, 20, 25, 32                         | 240                    | —          |
| NITD                  | 2, 4, 6, 10, 16, 20, 25, 32                         | 550                    | —          |
|                       | 20M25*, 20M32*, 32M40*, 32M50*, 32M63*              | 415                    | —          |
| AAO                   | 2, 4, 6, 10, 16, 20, 25, 32, 32M40*, 32M50*, 32M63* | 550                    | —          |
| BAO                   | 40, 50, 63, 63M80*, 63M100*                         | 550                    | A3         |
| CEO                   | 32, 40, 50, 63, 80, 100                             | 550                    | A4         |
|                       | 100M125*, 100M160*, 100M200*                        | 415                    | A4         |
| DEO                   | 125, 160, 200, 200M250*, 200M315*                   | 415                    | —          |
| OSD                   | 80, 100   | 550                    | —          |
|                       | 100M125*, 100M160*                                  | 415                    | —          |

\*"M" indicates motor starter ratings.

#### To Order

To order, specify Basic Catalog Number and amp rating. Example: BAO-16

#### Recommended Fuse Blocks & Holders

| Basic Fuse Catalog Numbers | Block/Holder Catalog Numbers |
|----------------------------|------------------------------|
| NITD                       | CM32FC                       |
| AAO                        | CM32F                        |
| BAO                        | CM63F                        |
| OSD                        | CM100F                       |
| CEO                        | BH-0111                      |

Data Sheets 4123 (STD), 4106 (NITD), 4109 (AAO), 4112 (BAO), 4107 (OSD), 4115 (CEO) and 4117 (DEO)

Data Sheets 4105 (SSD), 4100 (NSD) and 4101 (ESD)

# BS 88 British Standard Low Voltage Fuses

## AC, AD, BC, BD, CD, DD, ED, EFS BS 88

### Specifications

**Description:** Low voltage fuses that comply with general purpose gG characteristics and available up to 400A with two hole mount and up to 1250A with four hole mount.

**Construction:** Ceramic body.

### Ratings:

Volts: — 415/550Vac, 250Vdc (See Catalog Numbers table)

Amps: — 2-400A (See Catalog Numbers table)  
 — 63M80-400M500A Motor Starter ratings (See Catalog Numbers table)

IR: — See Catalog Numbers table

**Agency Information:** CE, Meets the requirements of BS 88 Parts 1 and 2 and IEC 60269-1.

**Mounting:** Center bolted blades, two-hole mount.



### Basic Catalog Numbers

| Basic Catalog Numbers | Amp Ratings                                     | Interrupting Ratings |      | Max Voltage Ratings |     | BS 88 Ref. |
|-----------------------|---|----------------------|------|---------------------|-----|------------|
|                       |   | AC                   | DC   | AC                  | DC  |            |
| AC                    | 2, 4, 6, 10, 16, 20, 25, 32                     | 80kA                 | 40kA | 550                 | 250 | —          |
| AD                    | 2, 4, 6, 10, 16, 20, 25, 32                     | 80kA                 | 40kA | 550                 | 250 | —          |
| BC                    | 40, 50, 63<br>63M80*, 63M100*                   | 80kA                 | 40kA | 550                 | 250 | —          |
| BD                    | 40, 50, 63                                      | 80kA                 | —    | 550                 | —   | —          |
| CD                    | 40, 50, 63                                      | 80kA                 | 40kA | 550                 | 250 | —          |
| DD                    | 80, 100, 100M125*, 100M160*, 100M200*, 100M200* | 80kA                 | —    | 415                 | —   | B1         |
| ED                    | 125, 160, 200, 200M250*, 200M315*               | 80kA                 | —    | 415                 | —   | B2         |
| EFS                   | 250, 315, 355, 400, 315M400*, 400M500*          | 80kA                 | —    | 415                 | —   | B3<br>B4   |
| EFS                   | 125, 160, 200, 250, 315                         | 80kA                 | —    | 415                 | —   | —          |

\*"M" indicates motor starter ratings.

### To Order

To order, specify Basic Catalog Number and amp rating. Example: BC-40

### Recommended Fuse Blocks & Holder

| Basic Fuse Catalog Numbers | Block/Holder Catalog Numbers |
|----------------------------|------------------------------|
| AC                         | BH-0111 Modular fuse block   |
| AD                         | 200DF Fuse holder            |
| BC                         | BH-0111 Modular fuse block   |
| BD                         | 200DF Fuse holder            |
| CD                         | 200DF Fuse holder            |
| DD                         | 200DF Fuse holder            |
| ED                         | BH-1131 Modular fuse block   |

Data Sheets 4110 (AC), 4111 (AD), 4113 (BC), 4114 (BD), 4116 (CD), 4118 (DD), 4119 (ED) and 4121 (EFS)

## EF, FF, FG, GF, GG, GH BS 88

### Specifications

**Description:** Low voltage fuses complying with general purpose gG characteristics and available up to 400A with two hole mount and up to 1250A with four hole mount.

**Construction:** Ceramic body.

### Ratings:

Volts: — 415/550Vac, 250/400Vdc (See Catalog Numbers table for details)

Amps: — 355-1250

IR: — See Catalog Numbers table

**Agency Information:** CE, Meets the requirements of BS 88 Parts 1 and 2 and IEC269-1.

**Mounting:** Center bolted blades, four-hole mount.



### Basic Catalog Numbers

| Basic Catalog Numbers | Amp Ratings            | Interrupting Ratings |      | Max Voltage Ratings |     | BS 88 Ref. |
|-----------------------|------------------------|----------------------|------|---------------------|-----|------------|
|                       |                        | AC                   | DC   | AC                  | DC  |            |
| EF                    | 355, 400<br>400M500*   | 80kA                 | —    | 415                 | —   | C1         |
| FF                    | 450, 500, 560, 630     | 80kA                 | 40kA | 550                 | 400 | C2         |
| FG                    | 450, 500, 560, 630     | 80kA                 | 40kA | 550                 | 400 | —          |
| GF                    | 710, 800               | 80kA                 | 40kA | 550                 | 250 | C3         |
| GG                    | 710, 800<br>1000, 1250 | 80kA                 | 40kA | 550                 | 250 | —          |
| GH                    | 710, 800, 1000, 1250   | 80kA                 | —    | 550                 | —   | —          |

\*"M" indicates motor starter ratings.

### To Order

To order, specify Basic Catalog Number and amp rating. Example: FG-450

Data Sheets 4120 (EF), 4102 (FF), 4122 (FG), 4103 (GF), 4104 (GG) and 4108 (GH)

# DIN Style Type D and Neozed Low Voltage Fuses

## D16, D27, D33, D125 Type D

**Specifications**

**Description:** DIN style Type D low voltage fuses.

**Dimensions:** See Catalog Numbers table and Dimensions illustrations.

**Construction:** Ceramic body.

**Ratings:**

Volts: — 500Vac

Amps: — 2-100A

IR: — 100kA

**Agency Information:** CE, "D" type fuses complying with DIN 49360 Part 2 and DIN 49515, operating class gL.

**Catalog Numbers**

| Catalog Numbers | Amp Ratings | Dimension "D" (mm) | Color Code | Figure Number |
|-----------------|-------------|--------------------|------------|---------------|
| 2D16            | 2           | 6                  | Pink       | 1             |
| 4D16            | 4           | 6                  | Brown      |               |
| 6D16            | 6           | 6                  | Green      |               |
| 10D16           | 10          | 8                  | Red        |               |
| 16D16           | 16          | 10                 | Grey       |               |
| 20D16           | 20          | 12                 | Blue       |               |
| 25D16           | 25          | 14                 | Yellow     |               |
| 2D27            | 2           | 6                  | Pink       | 2             |
| 4D27            | 4           | 6                  | Brown      |               |
| 6D27            | 6           | 6                  | Green      |               |
| 10D27           | 10          | 8                  | Red        |               |
| 16D27           | 16          | 10                 | Grey       |               |
| 20D27           | 20          | 12                 | Blue       |               |
| 25D27           | 25          | 14                 | Yellow     |               |
| 35D33           | 35          | 16                 | Black      | 3             |
| 50D33           | 50          | 18                 | White      |               |
| 63D33           | 63          | 20                 | Copper     |               |
| 80D125          | 80          | 5                  | Silver     | 4             |
| 100D125         | 100         | 7                  | Red        |               |

Additional Fuselinks: Quick acting fuselinks in body sized D16, D27, D33 and D125 rated 2-100A. Reference number suffixed Q, i.e. 10D27Q. Voltage rating 500V. Gauge rings and keys can also be supplied.

**Dimensions (mm)**

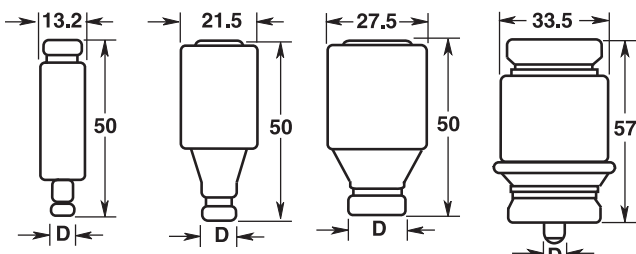

Figure 1

Figure 2

Figure 3

Figure 4

Data Sheet: 4124

## NZ01, NZ02 Type D0

**Specifications**

**Description:** Low voltage Neozed fuses suitable for use on 250Vdc systems.

**Dimensions:** See Catalog Numbers table and Dimensions illustration.

**Construction:** Ceramic body.

**Ratings:**

Volts: — 400Vac

Amps: — 2-63A

IR: — 100kA

**Agency Information:** CE

**Catalog Numbers**

| Catalog Numbers | Amp Ratings | Dimension "D" (mm) | Color Code |
|-----------------|-------------|--------------------|------------|
| 2NZ01           | 2           | 11                 | Pink       |
| 4NZ01           | 4           | 11                 | Brown      |
| 6NZ01           | 6           | 11                 | Green      |
| 10NZ01          | 10          | 11                 | Red        |
| 16NZ01          | 16          | 11                 | Grey       |
| 20NZ02          | 20          | 15                 | Blue       |
| 25NZ02          | 25          | 15                 | Yellow     |
| 35NZ02          | 35          | 15                 | Black      |
| 50NZ02          | 50          | 15                 | White      |
| 63NZ02          | 63          | 15                 | Copper     |

**Dimensions (mm)**

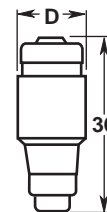

Data Sheet: 4124

IEC & British Fuses

# NH HRC Fuses

## \_\_NHG\_\_B

**Specifications**

**Class:** gG/gL

**Description:** DIN square bodied, dual indication industrial fuses.

**Construction:** Steatite insulator, corrosion-proof (aluminum) metal parts with full-contact, silver-plated copper blades.

**Sizes:** DIN 000 to 4.

**Selectivity Ratio:** 1:1.6 up to 500Vac.



**Ratings:**

Volts: — 500Vac/250Vdc

— 690Vac/250Vdc

Amps: — 2-1250A

IR: — 120kA

Frequency: — 50Hz

Operating Frequency: — 45-62Hz

**Agency Information:** IEC 60269, VDE0636, DIN 43620 Part 1 to 4, VDE Mark and CE.

| Fuse Blocks | Size         |
|-------------|--------------|
| SB00-D      | 000-00       |
| SB1-D       | 1*, 1        |
| SB2-D       | 02, 2, 03, 3 |

**Dimensions (mm)**

| Fuse Size | a <sup>1</sup> | a <sup>2</sup> (max) | a <sup>3</sup> | a <sup>4</sup> | b (nom) | c <sup>1</sup> (± 8) | c <sup>2</sup> (nom) | D (nom)   | e <sup>1</sup> (max) | e <sup>2</sup> (max) | e <sup>3</sup> (max) | e <sup>4</sup> (nom) | f (max) |
|-----------|----------------|----------------------|----------------|----------------|---------|----------------------|----------------------|-----------|----------------------|----------------------|----------------------|----------------------|---------|
| 000       | 78.5 ± 1.5     | 54                   | 45 ± 1.5       | 49 ± 1.5       | 15      | 35                   | 10                   | 2 ± 0.5   | 41                   | 21                   | 16                   | 6                    | 8       |
| 00        | 78.5 ± 1.5     | 54                   | 45 ± 1.5       | 49 ± 1.5       | 15      | 35                   | 11                   | 7.0 ± 0.5 | 48                   | 30                   | 25                   | 6                    | 15      |
| 0         | 125 ± 2.5      | 68                   | 62 +3/-1.5     | 68 +1.5/-3     | 15      | 35                   | 11                   | 2.5 ± 0.5 | 48                   | 30                   | 25                   | 6                    | 15      |
| 01        | 135 ± 2.5      | 75                   | 62 ± 2.5       | 68 ± 2.5       | 15      | 40                   | 11                   | 2.5 ± 0.5 | 48                   | 30                   | 25                   | 6                    | 15      |
| 1         | 135 ± 2.5      | 75                   | 62 ± 2.5       | 68 ± 2.5       | 20      | 40                   | 11                   | 2.5 ± 0.5 | 53                   | 52                   | 25                   | 6                    | 15      |
| 02        | 150 ± 2.5      | 75                   | 62 ± 2.5       | 68 ± 2.5       | 20      | 48                   | 11                   | 2.5 ± 0.5 | 53                   | 52                   | 25                   | 6                    | 15      |
| 2         | 150 ± 2.5      | 75                   | 62 ± 2.5       | 68 ± 2.5       | 25      | 48                   | 11                   | 2.5 ± 0.5 | 61                   | 60                   | 25                   | 6                    | 15      |
| 03        | 150 ± 3        | 75                   | 62 ± 2.5       | 68 ± 2.5       | 25      | 60                   | 11                   | 2.5 ± 0.5 | 61                   | 60                   | 25                   | 6                    | 15      |
| 3         | 150 ± 3        | 75                   | 62 ± 2.5       | 68 ± 2.5       | 32      | 60                   | 11                   | 3.0 ± 0.5 | 75                   | 70                   | 25                   | 6                    | 18      |
| 4         | 200            | 84                   | 80             | 90             | 50      | 85                   | 11                   | 3         | 120                  | 87                   | —                    | 8                    | 30      |

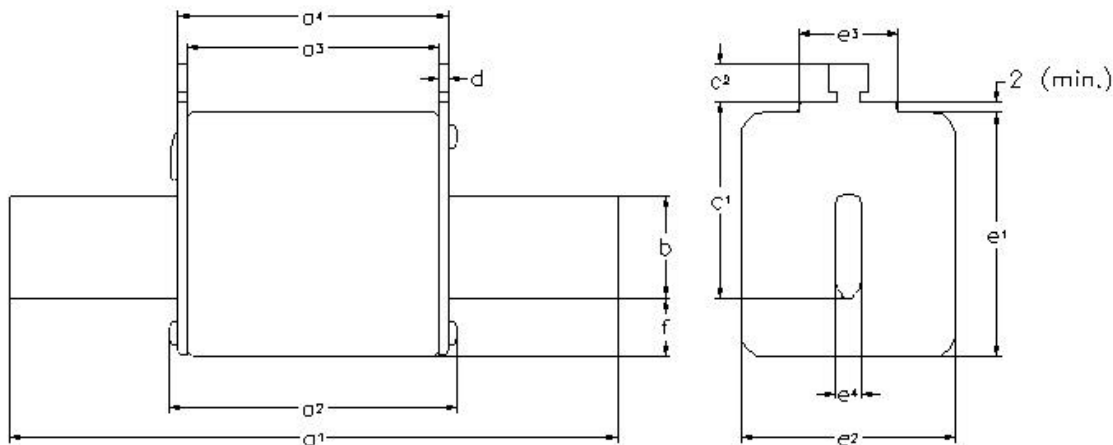







## NH HRC Fuses

| 500Vac / 250Vdc | Size                              | Rated Current (Amps) | gG/gL Dual Indicator Voltage Conducting Metal Gripping Lugs | Carton Quantity |
|-----------------|-----------------------------------|----------------------|---|-----------------|
|                 | 000                               | 2                    | 2NHG00B   | 3               |
|                 |                                   | 4                    | 4NHG00B   | 3               |
|                 |                                   | 6                    | 6NHG00B   | 3               |
|                 |                                   | 10                   | 10NHG00B  | 3               |
|                 |                                   | 16                   | 16NHG00B  | 3               |
|                 |                                   | 20                   | 20NHG00B  | 3               |
|                 |                                   | 25                   | 25NHG00B  | 3               |
|                 |                                   | 32                   | 32NHG00B  | 3               |
|                 |                                   | 35                   | 35NHG00B  | 3               |
|                 |                                   | 40                   | 40NHG00B  | 3               |
|                 |                                   | 50                   | 50NHG00B  | 3               |
|                 |                                   | 63                   | 63NHG00B  | 3               |
|                 |                                   | 80                   | 80NHG00B  | 3               |
|                 |                                   | 100                  | 100NHG00B   | 3               |
|                 | 00                                | 125                  | 125NHG00B   | 3               |
|                 |                                   | 160                  | 160NHG00B   | 3               |
|                 |                                   | 10                   | 10NHGOB   | 3               |
|                 |                                   | 16                   | 16NHGOB   | 3               |
|                 |                                   | 20                   | 20NHGOB   | 3               |
|                 |                                   | 25                   | 25NHGOB   | 3               |
|                 | 0                                 | 32                   | 32NHGOB   | 3               |
|                 |                                   | 35                   | 35NHGOB   | 3               |
|                 |                                   | 40                   | 40NHGOB   | 3               |
|                 |                                   | 50                   | 50NHGOB   | 3               |
|                 |                                   | 63                   | 63NHGOB   | 3               |
|                 |                                   | 80                   | 80NHGOB   | 3               |
|                 |                                   | 100                  | 100NHGOB  | 3               |
|                 |                                   | 125                  | 125NHGOB  | 3               |
|                 |                                   | 160                  | 160NHGOB  | 3               |
|                 |                                   | 01                   | 10  | 10NHG01B        |
|                 | 16                                |                      | 16NHG01B  | 3               |
|                 | 20                                |                      | 20NHG01B  | 3               |
|                 | 25                                |                      | 25NHG01B  | 3               |
|                 | 32                                |                      | 32NHG01B  | 3               |
|                 | 35                                |                      | 35NHG01B  | 3               |
|                 | 40                                |                      | 40NHG01B  | 3               |
|                 | 50                                |                      | 50NHG01B  | 3               |
|                 | 63                                |                      | 63NHG01B  | 3               |
|                 | 80                                |                      | 80NHG01B  | 3               |
|                 | 100                               |                      | 100NHG01B   | 3               |
|                 | 125                               |                      | 125NHG01B   | 3               |
|                 | 160                               |                      | 160NHG01B   | 3               |
|                 | 200                               |                      | 200NHG1B  | 3               |
|                 | 224                               | 224NHG1B             | 3   |                 |
|                 | 1                                 | 250                  | 250NHG1B  | 3               |
|                 |                                   | 35                   | 35NHG02B  | 3               |
|                 |                                   | 40                   | 40NHG02B  | 3               |
|                 |                                   | 50                   | 50NHG02B  | 3               |
|                 |                                   | 63                   | 63NHG02B  | 3               |
|                 |                                   | 80                   | 80NHG02B  | 3               |
|                 |                                   | 100                  | 100NHG02B   | 3               |
|                 |                                   | 125                  | 125NHG02B   | 3               |
|                 |                                   | 160                  | 160NHG02B   | 3               |
|                 |                                   | 200                  | 200NHG02B   | 3               |
|                 | 2                                 | 224                  | 224NHG02B   | 3               |
|                 |                                   | 250                  | 250NHG02B   | 3               |
|                 |                                   | 315                  | 315NHG2B  | 3               |
|                 |                                   | 355                  | 355NHG2B  | 3               |
|                 |                                   | 400                  | 400NHG2B  | 3               |
|                 |                                   | 250                  | 250NHG03B   | 3               |
|                 | 3                                 | 315                  | 315NHG03B   | 3               |
|                 |                                   | 355                  | 355NHG03B   | 3               |
|                 |                                   | 400                  | 400NHG03B   | 3               |
|                 | 4                                 | 500                  | 500NHG3B  | 3               |
|                 |                                   | 630                  | 630NHG3B  | 3               |
|                 | Single Indicator Slotted End Tags | 500                  | 500NHG4G  | 1               |
|                 |                                   | 630                  | 630NHG4G  | 1               |
|                 |                                   | 800                  | 800NHG4G  | 1               |
|                 |                                   | 1000                 | 1000NHG4G   | 1               |
|                 |                                   | 1250                 | 1250NHG4G   | 1               |



IEC & British Fuses

## NH HRC Fuses

| 690Vac / 250Vdc   | Size | Rated Current (Amps)  | gG/gL Dual Indicator Voltage Conducting Metal Gripping Lugs | Carton Quantity |              |   |
|---|------|---|---|-----------------|--------------|---|
|    | 000  | 2   | 2NHG000B-690  | 3               |              |   |
|   |      | 4   | 4NHG000B-690  | 3               |              |   |
|   |      | 6   | 6NHG000B-690  | 3               |              |   |
|   |      | 10  | 10NHG000B-690   | 3               |              |   |
|   |      | 16  | 16NHG000B-690   | 3               |              |   |
|   |      | 20  | 20NHG000B-690   | 3               |              |   |
|   |      | 25  | 25NHG000B-690   | 3               |              |   |
|   |      | 32  | 32NHG000B-690   | 3               |              |   |
|   |      | 35  | 35NHG000B-690   | 3               |              |   |
|   |      | 40  | 40NHG000B-690   | 3               |              |   |
|   | 00   | 50  | 50NHG00B-690  | 3               |              |   |
|   |      | 63  | 63NHG00B-690  | 3               |              |   |
|   |      | 80  | 80NHG00B-690  | 3               |              |   |
|   |      | 100   | 100NHG00B-690   | 3               |              |   |
|   |      | 6   | 6NHGOB-690  | 3               |              |   |
|   |      | 10  | 10NHGOB-690   | 3               |              |   |
|   |      | 16  | 16NHGOB-690   | 3               |              |   |
|   |      | 20  | 20NHGOB-690   | 3               |              |   |
|   |      | 25  | 25NHGOB-690   | 3               |              |   |
|   |      | 32  | 32NHGOB-690   | 3               |              |   |
|  | 0    | 35  | 35NHGOB-690   | 3               |              |   |
|   |      | 40  | 40NHGOB-690   | 3               |              |   |
|   |      | 50  | 50NHGOB-690   | 3               |              |   |
|   |      | 63  | 63NHGOB-690   | 3               |              |   |
|   |      | 80  | 80NHGOB-690   | 3               |              |   |
|   |      | 100   | 100NHGOB-690  | 3               |              |   |
|   |      | 50  | 50NHG1B-690   | 3               |              |   |
|   |      | 63  | 63NHG1B-690   | 3               |              |   |
|   |      | 80  | 80NHG1B-690   | 3               |              |   |
|   |      | 100   | 100NHG1B-690  | 3               |              |   |
|  | 1    | 125   | 125NHG1B-690  | 3               |              |   |
|   |      | 160   | 160NHG1B-690  | 3               |              |   |
|   |      | 200   | 200NHG1B-690  | 3               |              |   |
|   |      | 63  | 63NHG2B-690   | 3               |              |   |
|   |      | 80  | 80NHG2B-690   | 3               |              |   |
|   |      | 100   | 100NHG2B-690  | 3               |              |   |
|   |      | 125   | 125NHG2B-690  | 3               |              |   |
|   |      | 160   | 160NHG2B-690  | 3               |              |   |
|   |      | 200   | 200NHG2B-690  | 3               |              |   |
|   |      | 224   | 224NHG2B-690  | 3               |              |   |
|  | 2    | 250   | 250NHG2B-690  | 3               |              |   |
|   |      | 315   | 315NHG2B-690  | 3               |              |   |
|   |      | 250   | 250NHG3B-690  | 3               |              |   |
|   |      | 315   | 315NHG3B-690  | 3               |              |   |
|   |      |  | 3   | 355             | 355NHG3B-690 | 3 |
|   |      |   |   | 400             | 400NHG3B-690 | 3 |
|   |      |   |   | 425             | 425NHG3B-690 | 3 |
|   |      |   |   | 500             | 500NHG3B-690 | 3 |

## NH Fuse Bases

### SB\*-D, SB\*-S

Up to 690V / 160 - 1250A

Sizes 00, 0, 1, 2, 3, 4



**Description:** NH fuse bases with thermoplastic bodies. DIN rail and screw mounting (size 4 screw fix). Range of protection accessories for live parts in order to obtain IP20 protection standard.

#### Ratings:

- Voltage: up to 690Vac
- Amps: 2 to 1250A

**Applications:** Protection of industrial circuits and electrical apparatus

**Standards and Approvals:** IEC 60269, DIN 43620



#### Part Numbers

| Size | Poles  | Current (Amps) | Part Numbers                  | Carton Quantity | Compatible Fuse Size |
|------|--------|----------------|-------------------------------|-----------------|----------------------|
|      |        |                | DIN Screw                     |                 |                      |
| 00   | 1<br>3 | 160A           | SB00-D                        | 3               | 000 & 00             |
|      |        |                | TB00-D<br>TB00-D-IP20         |                 |                      |
| 0    | 1<br>3 | 160A           | SB0-D                         | 3               | 0                    |
|      |        |                | TB0-D                         |                 |                      |
| 1    | 1<br>3 | 250A           | SB1-D                         | 3               | 01 & 1               |
|      |        |                | TB1-D                         |                 |                      |
| 2    | 1<br>3 | 400A           | SB2-D                         | 3               | 02 & 2               |
|      |        |                | TB2-D                         |                 |                      |
| 3    | 1<br>3 | 630A           | SB3-D                         | 3               | 03 & 3               |
|      |        |                | TB3-D                         |                 |                      |
| 4    | 1      | 1250A          | SB4-S (Screw Connection only) | 3               | 4                    |

#### Neutral

| Size | Current (Amps) | Part Ref | Carton Quantity |
|------|----------------|----------|-----------------|
| NH00 | 160            | SL00     | 3               |
| NH0  | 160            | SL0      |                 |
| NH1  | 250            | SL1      |                 |
| NH2  | 400            | SL2      |                 |
| NH3  | 630            | SL3      |                 |
| NH4  | 1000           | SL4      |                 |



#### Fuse extraction handle

| Size  | Part Ref | Carton Quantity |
|-------|----------|-----------------|
| C00-3 | FEH      | 1               |



#### Protection accessories

| Size  | Current (Amps) | Separation Partition ④ |                 | Fuse Casing ⑤ |                 | Terminal Cover ① |                 | Separator ③ |                 |
|-------|----------------|------------------------|-----------------|---------------|-----------------|------------------|-----------------|-------------|-----------------|
|       |                | Part Ref               | Carton Quantity | Part Ref      | Carton Quantity | Part Ref         | Carton Quantity | Part Ref    | Carton Quantity |
| NH00* | 160A           | SP00*                  | 2               | FC00*         | 3               | CS00*            | 6               | BC00*       | 2               |
| NH0   | 160A           | SP0                    | 2               | FC0           | 3               | CS0              | 6               | BC0         | 2               |
| NH1   | 250A           | SP1-2                  | 2               | FC1-2         | 3               | CS1              | 6               | BC1-2       | 2               |
| NH2   | 400A           | SP1-2                  | 2               | FC1-2         | 3               | CS2              | 6               | BC1-2       | 2               |
| NH3   | 630A           | SP3                    | 2               | FC3           | 3               | CS3              | 6               | BC3         | 2               |

\* For single pole only

#### IP Protection Kits

| Part Reference | Description                               |
|----------------|---|
| TB00-D-IP20    | Complete triple pole fuse base IP20 rated |
| FPK0-3P        | IP20 kit for TB0-D fuse base              |
| FPK1-3P        | IP20 kit for TB1-D fuse base              |
| FPK2-3P        | IP20 kit for TB2-D fuse base              |
| FPK3-3P        | IP20 kit for TB3-D fuse base              |

#### Microswitch

| Part Ref | Carton Quantity |
|----------|-----------------|
| BVL-50   | 1               |



Microswitch suitable for the following NH Fuse links:

- 400 Volts gG/gL
- 500 Volts gG/gL and aM
- 690 Volts gG/gL and aM

## Class gG/gL IEC 60269 Industrial Ferrule Fuses

8 x 31mm: 400Vac, 0.5 - 25A

| Catalog Number | Rated Amps | Rated Voltage | Dimensions (mm) |      |     |
|----------------|------------|---------------|-----------------|------|-----|
|                |            |               | A               | B    | C   |
| C08G0-5        | 0.5        | 400Vac        | 8.5             | 31.5 | 6.3 |
| C08G1          | 1          |               |                 |      |     |
| C08G2          | 2          |               |                 |      |     |
| C08G4          | 4          |               |                 |      |     |
| C08G6          | 6          |               |                 |      |     |
| C08G8          | 8          |               |                 |      |     |
| C08G10         | 10         |               |                 |      |     |
| C08G12         | 12         |               |                 |      |     |
| C08G16         | 16         |               |                 |      |     |
| C08G20         | 20         |               |                 |      |     |
| C08G25         | 25         |               |                 |      |     |

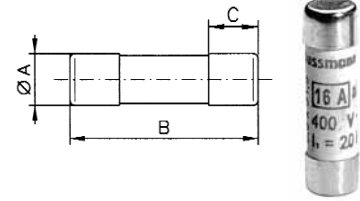

10 x 38mm: 500Vac, 0.5 - 32A

| Catalog Number | Rated Amps | Rated Voltage | Dimensions (mm) |    |    |
|----------------|------------|---------------|-----------------|----|----|
|                |            |               | A               | B  | C  |
| C10G0-5        | 0.5        | 500Vac        | 10.3            | 38 | 10 |
| C10G1          | 1          |               |                 |    |    |
| C10G2          | 2          |               |                 |    |    |
| C10G4          | 4          |               |                 |    |    |
| C10G6          | 6          |               |                 |    |    |
| C10G8          | 8          |               |                 |    |    |
| C10G10         | 10         |               |                 |    |    |
| C10G12         | 12         |               |                 |    |    |
| C10G16         | 16         |               |                 |    |    |
| C10G20         | 20         |               |                 |    |    |
| C10G25         | 25         |               |                 |    |    |
| C10G32         | 32         |               |                 |    |    |
| C10G32         | 32         |               |                 |    |    |

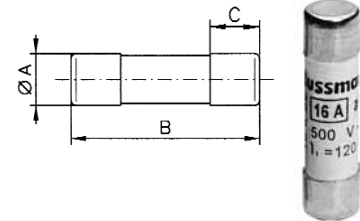

14 x 51mm: 400Vac - 500Vac - 690Vac, 1 - 50A

| Catalog Number | Rated Amps | Rated Voltage | Dimensions (mm) |    |    |   |   |
|----------------|------------|---------------|-----------------|----|----|---|---|
|                |            |               | A               | B  | C  | D | E |
| C14G1          | 1          | 690Vac        | 14.3            | 51 | 13 | 8 | 4 |
| C14G2          | 2          |               |                 |    |    |   |   |
| C14G4          | 4          |               |                 |    |    |   |   |
| C14G6          | 6          |               |                 |    |    |   |   |
| C14G8          | 8          |               |                 |    |    |   |   |
| C14G10         | 10         |               |                 |    |    |   |   |
| C14G12         | 12         |               |                 |    |    |   |   |
| C14G16         | 16         |               |                 |    |    |   |   |
| C14G20         | 20         |               |                 |    |    |   |   |
| C14G25         | 25         |               |                 |    |    |   |   |
| C14G32         | 32         |               |                 |    |    |   |   |
| C14G40         | 40         |               |                 |    |    |   |   |
| C14G50         | 50         |               |                 |    |    |   |   |
| C14G32         | 32         | 500Vac        |                 |    |    |   |   |
| C14G40         | 40         | 400Vac        |                 |    |    |   |   |
| C14G50         | 50         |               |                 |    |    |   |   |

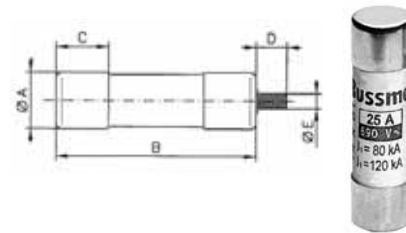

22 x 58mm: 400Vac - 500Vac - 690Vac, 2 - 125A

| Catalog Number | Rated Amps | Rated Voltage | Dimensions (mm) |    |    |   |   |
|----------------|------------|---------------|-----------------|----|----|---|---|
|                |            |               | A               | B  | C  | D | E |
| C22G2          | 2          | 690Vac        | 22.2            | 58 | 16 | 8 | 4 |
| C22G4          | 4          |               |                 |    |    |   |   |
| C22G6          | 6          |               |                 |    |    |   |   |
| C22G8          | 8          |               |                 |    |    |   |   |
| C22G10         | 10         |               |                 |    |    |   |   |
| C22G12         | 12         |               |                 |    |    |   |   |
| C22G16         | 16         |               |                 |    |    |   |   |
| C22G20         | 20         |               |                 |    |    |   |   |
| C22G25         | 25         |               |                 |    |    |   |   |
| C22G32         | 32         |               |                 |    |    |   |   |
| C22G40         | 40         |               |                 |    |    |   |   |
| C22G50         | 50         |               |                 |    |    |   |   |
| C22G63         | 63         |               |                 |    |    |   |   |
| C22G80         | 80         |               |                 |    |    |   |   |
| C22G100        | 100        |               |                 |    |    |   |   |
| C22G125        | 125        |               |                 |    |    |   |   |
| C22G100        | 100        | 500Vac        |                 |    |    |   |   |
| C22G125        | 125        | 400Vac        |                 |    |    |   |   |

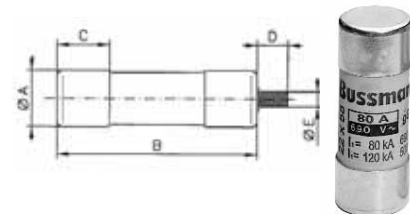



## Class aM IEC Industrial Ferrule Fuses - Class aM IEC 60269

8 x 31mm: 400Vac, 1 - 8A

| Catalog Number | Rated Amps | Rated Voltage | Dimensions (mm) |      |     |
|----------------|------------|---------------|-----------------|------|-----|
|                |            |               | A               | B    | C   |
| C08M1          | 1          | 400Vac        | 8.5             | 31.5 | 6.3 |
| C08M2          | 2          |               |                 |      |     |
| C08M4          | 4          |               |                 |      |     |
| C08M6          | 6          |               |                 |      |     |
| C08M8          | 8          |               |                 |      |     |

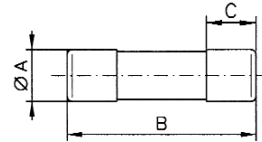

10 x 38mm: 400Vac - 550Vac, 0.16 - 25A

| Catalog Number | Rated Amps | Rated Voltage | Dimensions (mm) |      |      |
|----------------|------------|---------------|-----------------|------|------|
|                |            |               | A               | B    | C    |
| C10M0-16       | 0.16       | 550Vac        | 10.3            | 38.0 | 10.0 |
| C10M0-25       | 0.25       |               |                 |      |      |
| C10M0-5        | 0.5        |               |                 |      |      |
| C10M1          | 1          |               |                 |      |      |
| C10M2          | 2          |               |                 |      |      |
| C10M4          | 4          |               |                 |      |      |
| C10M6          | 6          |               |                 |      |      |
| C10M8          | 8          |               |                 |      |      |
| C10M10         | 10         |               |                 |      |      |
| C10M12         | 12         |               |                 |      |      |
| C10M16         | 16         |               |                 |      |      |
| C10M20         | 20         | 400Vac        | 10.3            | 38.0 | 10.0 |
| C10M25         | 25         |               |                 |      |      |



14 x 51mm: 690Vac - 500Vac, 0.25 - 50A

| Catalog Number | Rated Amps | Rated Voltage | Dimensions (mm) |    |    |
|----------------|------------|---------------|-----------------|----|----|
|                |            |               | A               | B  | C  |
| C14M0-25       | 0.25       | 690Vac        | 14.3            | 51 | 13 |
| C14M1          | 1          |               |                 |    |    |
| C14M2          | 2          |               |                 |    |    |
| C14M4          | 4          |               |                 |    |    |
| C14M6          | 6          |               |                 |    |    |
| C14M8          | 8          |               |                 |    |    |
| C14M10         | 10         |               |                 |    |    |
| C14M12         | 12         |               |                 |    |    |
| C14M16         | 16         |               |                 |    |    |
| C14M20         | 20         |               |                 |    |    |
| C14M25         | 25         |               |                 |    |    |
| C14M32         | 32         |               |                 |    |    |
| C14M40         | 40         |               |                 |    |    |
| C14M50         | 50         |               |                 |    |    |
|                |            |               |                 |    |    |

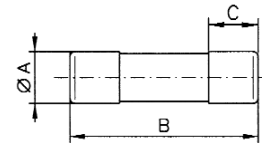

22 x 58mm: 400Vac - 500Vac - 690Vac, 2 - 125A

| Catalog Number | Rated Amps | Rated Voltage | Dimensions (mm) |    |    |
|----------------|------------|---------------|-----------------|----|----|
|                |            |               | A               | B  | C  |
| C22M2          | 2          | 690Vac        | 22.2            | 58 | 16 |
| C22M4          | 4          |               |                 |    |    |
| C22M6          | 6          |               |                 |    |    |
| C22M8          | 8          |               |                 |    |    |
| C22M10         | 10         |               |                 |    |    |
| C22M12         | 12         |               |                 |    |    |
| C22M16         | 16         |               |                 |    |    |
| C22M20         | 20         |               |                 |    |    |
| C22M25         | 25         |               |                 |    |    |
| C22M32         | 32         |               |                 |    |    |
| C22M40         | 40         |               |                 |    |    |
| C22M50         | 50         |               |                 |    |    |
| C22M63         | 63         |               |                 |    |    |
| C22M80         | 80         |               |                 |    |    |
| C22M100        | 100        | 500Vac        | 22.2            | 58 | 16 |
| C22M125        | 125        |               |                 |    |    |
|                |            | 400Vac        |                 |    |    |

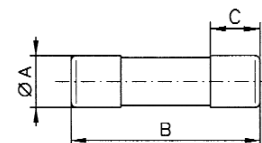

Neutral Links

| Catalog Number | Product Class |
|----------------|---------------|
| C8NL           | QR            |
| C10NL          |               |
| C14NL          |               |
| C22NL          |               |

IEC & British Fuses

# Class aM & gG/gL IEC Industrial Ferrule Fuses with Striker

14 X 51



## Class gG/gL with Striker

| Catalog Number With Striker | Amp Rating | Watts Loss (W) | Voltage (AC) | Interrupting Rating (kA) |
|-----------------------------|------------|----------------|--------------|--------------------------|
| C14G2S                      | 2          | 0.24           | 500          | 120                      |
| C14G4S                      | 4          | 0.45           |              |                          |
| C14G6S                      | 6          | 0.42           |              |                          |
| C14G8S                      | 8          | 0.70           |              |                          |
| C14G10S                     | 10         | 0.53           |              |                          |
| C14G12S                     | 12         | 0.88           |              |                          |
| C14G16S                     | 16         | 1.16           |              |                          |
| C14G20S                     | 20         | 1.23           |              |                          |
| C14G25S                     | 25         | 1.46           |              |                          |
| C14G32S                     | 32         | 2.04           |              |                          |
| C14G40S                     | 40         | 3.34           |              |                          |
| C14G50S                     | 50         | 3.04           |              |                          |

22 X 58



| Catalog Number With Striker | Amp Rating | Watts Loss (W) | Voltage (AC) | Interrupting Rating (kA) |
|-----------------------------|------------|----------------|--------------|--------------------------|
| C22G4S                      | 4          | 0.48           | 690          | 80                       |
| C22G6S                      | 6          | 0.47           |              |                          |
| C22G8S                      | 8          | 0.73           |              |                          |
| C22G10S                     | 10         | 0.74           |              |                          |
| C22G12S                     | 12         | 0.83           |              |                          |
| C22G16S                     | 16         | 1.21           |              |                          |
| C22G20S                     | 20         | 1.29           |              |                          |
| C22G25S                     | 25         | 1.53           |              |                          |
| C22G32S                     | 32         | 2.13           |              |                          |
| C22G40S                     | 40         | 3.40           |              |                          |
| C22G50S                     | 50         | 3.48           |              |                          |
| C22G63S                     | 63         | 4.46           |              |                          |
| C22G80S                     | 80         | 5.86           |              |                          |
| C22G100S                    | 100        | 6.61           |              |                          |
| C22G125S                    | 125        | 8.42           |              |                          |

14 X 51



## Class aM with Striker

| Catalog Number With Striker | Amp Rating | Watts Loss (W) | Voltage (AC) | Interrupting Rating (kA) |
|-----------------------------|------------|----------------|--------------|--------------------------|
| C14M1S                      | 1          | 0.14           | 500          | 120                      |
| C14M2S                      | 2          | 0.24           |              |                          |
| C14M4S                      | 4          | 0.45           |              |                          |
| C14M6S                      | 6          | 0.42           |              |                          |
| C14M8S                      | 8          | 0.70           |              |                          |
| C14M10S                     | 10         | 0.53           |              |                          |
| C14M12S                     | 12         | 0.88           |              |                          |
| C14M16S                     | 16         | 1.16           |              |                          |
| C14M20S                     | 20         | 1.23           |              |                          |
| C14M25S                     | 25         | 1.46           |              |                          |
| C14M32S                     | 32         | 2.04           |              |                          |
| C14M40S                     | 40         | 3.34           |              |                          |
| C14M50S                     | 50         | 3.04           |              |                          |

22 X 58



| Catalog Number With Striker | Amp Rating | Watts Loss (W) | Voltage (AC) | Interrupting Rating (kA) |
|-----------------------------|------------|----------------|--------------|--------------------------|
| C22M2S                      | 2          | 0.29           | 690          | 80                       |
| C22M4S                      | 4          | 0.48           |              |                          |
| C22M6S                      | 6          | 0.47           |              |                          |
| C22M8S                      | 8          | 0.73           |              |                          |
| C22M10S                     | 10         | 0.74           |              |                          |
| C22M12S                     | 12         | 0.83           |              |                          |
| C22M16S                     | 16         | 1.21           |              |                          |
| C22M20S                     | 20         | 1.29           |              |                          |
| C22M25S                     | 25         | 1.53           |              |                          |
| C22M32S                     | 32         | 2.13           |              |                          |
| C22M40S                     | 40         | 3.40           |              |                          |
| C22M50S                     | 50         | 3.48           |              |                          |
| C22M63S                     | 63         | 4.46           |              |                          |
| C22M80S                     | 80         | 5.86           |              |                          |
| C22M100S                    | 100        | 6.61           |              |                          |
| C22M125S                    | 125        | 8.42           |              |                          |

## HRC Fuse Holders

### CAMaster

#### Specifications Catalog Symbol:

See table below.

**Description:** The CAMaster HRC fuse holder features a unique cam-action for easy fuse removal while allowing significantly improved contact pressure between fuse carrier and base contact that enhances electrical performance. A range of lockable safety carriers for the fuse holder (catalog reference: LSC), are available.

#### Ratings:

Volts: — 690V

Amps: — 30-100A (See Catalog Number table for details)

**Agency Information:** CE, CSA C22.2 No. 39; IEC 269 AND BS 88.

**Mounting:** 35mm DIN-rail or single screw mounting.

#### Catalog Numbers

| Catalog Numbers | Amp Ratings | Details For:         | Fuse Accepted |
|-----------------|-------------|----------------------|---------------|
| CM20CF          | 30          | HRCI-CA Applications | _CIF21        |
| CM30CF          | 30          |                      | _H07C         |
| CM60CF          | 60          | HRCII Applications   | _K07C         |
| CM100CF         | 100         |                      | _K07CR        |

#### Accessory Catalog Numbers for CAMaster Units

| Catalog Numbers | Amp Ratings | Details                    | Fuse Holder Accepted |
|-----------------|-------------|----------------------------|----------------------|
| 20BS            | 30          | Back Stud                  | CM20CF               |
| 32BS            | 30          |                            | CM30CF               |
| 60/100BS        | 60/100      |                            | CM60/100CF           |
| GLP             | All         | Ganging Link Kit           | 3-Pole               |
| NI              | All         | 660V Neon Indicator        | —                    |
| 20LSC           | 30          | Security Carrier with Clip | CM20CF               |
| 30LSC           | 30          |                            | CM30CF               |
| 60/100LSC       | 60/100A     |                            | CM60/100CF           |



### SAFEloc

#### Specifications Catalog Symbol:

See table below.

**Description:** The SAFEloc HRC fuse holders (for use with HRCI-CB fuses) provides a positive, stress-free fuse fitting and locks it in position to ensure safe insertion and withdrawal from the base. Base contacts are fully shrouded to help protect against electric shock. Shrouds utilize simple slide/snap action allowing access to the contact terminal screws.

#### Ratings:

Volts: — 600V

Amps: — 30-60A (See Catalog Number table for details)

**Agency Information:** CE, Designed to accommodate the compact range of offset blade fuse to CSA C22.2 No. 106, HRCI-CB.

**Mounting:** 35mm DIN rail or single screw mounting.

#### Catalog Numbers\*

| Catalog Numbers | Amp Ratings | Connection | Fuse Accepted |
|-----------------|-------------|------------|---------------|
| C30F            | 30          | Front      | _CIF06        |
| C30BS           |             | Back       |               |
| C30FBS          |             | Front-Back |               |
| C60F            | 60          | Front      | EK-Amp        |
| C60BS           |             | Back       |               |
| C60FBS          |             | Front-Back |               |

\*For use with HRCI-CB Fuses.



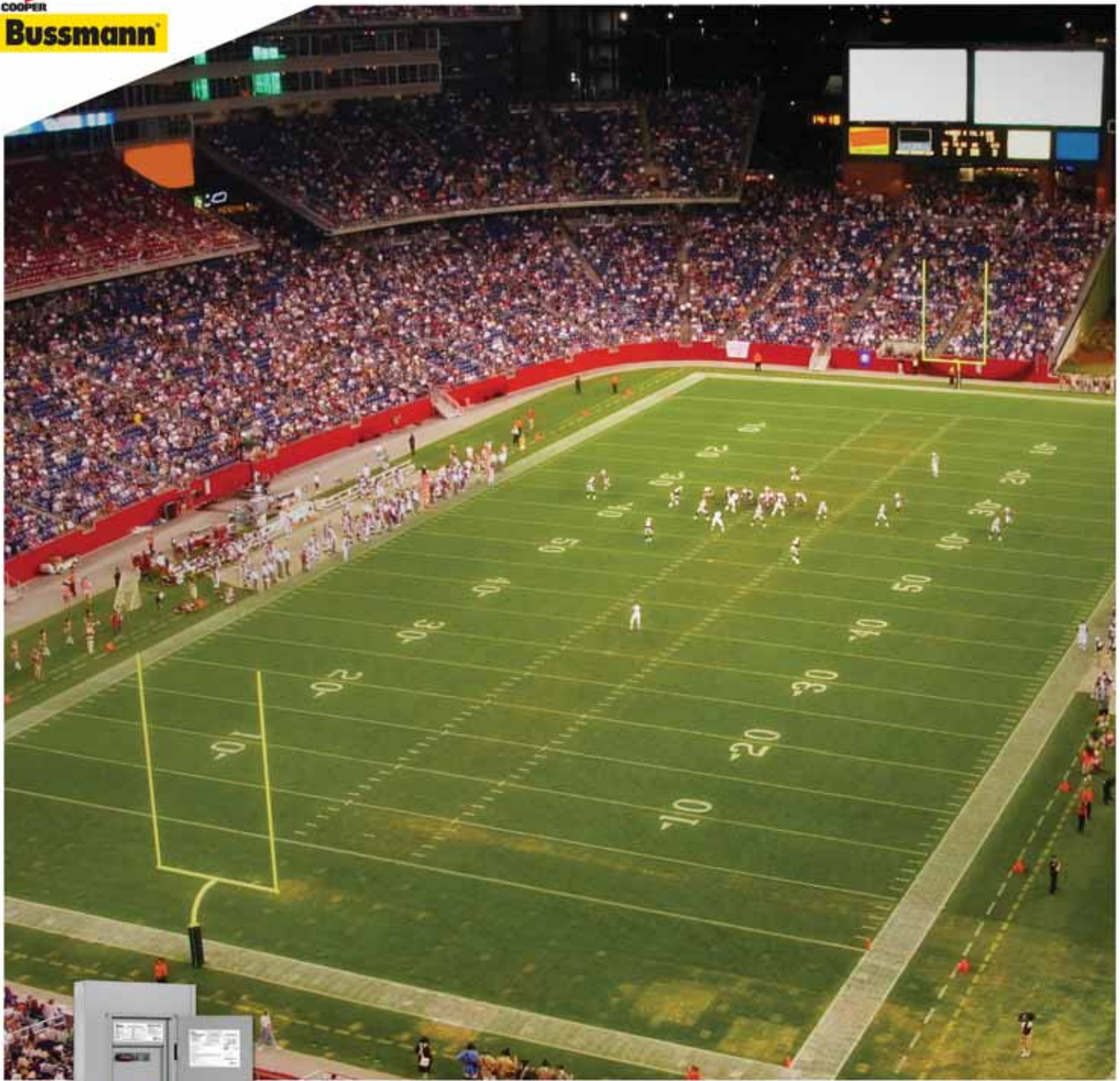

## Quik-Spec™ Coordination Panelboard

The New Standard in Panelboards Simplifies  
Selective Coordination with More Flexible  
Configurations and Features

Компания «Life Electronics» занимается поставками электронных компонентов импортного и отечественного производства от производителей и со складов крупных дистрибьюторов Европы, Америки и Азии.

С конца 2013 года компания активно расширяет линейку поставок компонентов по направлению коаксиальный кабель, кварцевые генераторы и конденсаторы (керамические, пленочные, электролитические), за счёт заключения дистрибьюторских договоров

Мы предлагаем:

- Конкурентоспособные цены и скидки постоянным клиентам.
- Специальные условия для постоянных клиентов.
- Подбор аналогов.
- Поставку компонентов в любых объемах, удовлетворяющих вашим потребностям.
- Приемлемые сроки поставки, возможна ускоренная поставка.
- Доставку товара в любую точку России и стран СНГ.
- Комплексную поставку.
- Работу по проектам и поставку образцов.
- Формирование склада под заказчика.
- Сертификаты соответствия на поставляемую продукцию (по желанию клиента).
- Тестирование поставляемой продукции.
- Поставку компонентов, требующих военную и космическую приемку.
- Входной контроль качества.
- Наличие сертификата ISO.

В составе нашей компании организован Конструкторский отдел, призванный помогать разработчикам, и инженерам.

Конструкторский отдел помогает осуществить:

- Регистрацию проекта у производителя компонентов.
- Техническую поддержку проекта.
- Защиту от снятия компонента с производства.
- Оценку стоимости проекта по компонентам.
- Изготовление тестовой платы монтаж и пусконаладочные работы.



Тел: +7 (812) 336 43 04 (многоканальный)

Email: [org@lifeelectronics.ru](mailto:org@lifeelectronics.ru)