

# Universal Programmable Clock Generator (UPCG)

## Features

- Spread spectrum, VCXO, and frequency select
- Input frequency range:
  - Crystal: 8–30 MHz
  - CLKIN: 0.5–100 MHz
- Output frequency:
  - Commercial: 1–200 MHz
  - Industrial: 1–166 MHz
- Integrated phase-locked loop
- Low jitter, high accuracy outputs
- 3.3 V operation
- 8-pin SOIC package

## Functional Description

The CY22800 is a multi-function clock generator that supports various applications in consumer and communications markets. The device uses the Cypress proprietary PLL along with spread spectrum and VCXO technology to make it one of the most versatile clock synthesizers in the marketplace. The CY22800 is a field-programmable synthesizer that can be programmed using an easy-to-use programmer dongle, CY36800, with one of many predefined configuration files for fast sample generation of prototype builds. The CY22800 is a reprogrammable device that can be programmed up to 100 times. The latest configurations available for this device are summarized in [CY22800 Configurations on page 5](#).

For a complete list of related documentation, click [here](#).

## Logic Block Diagram

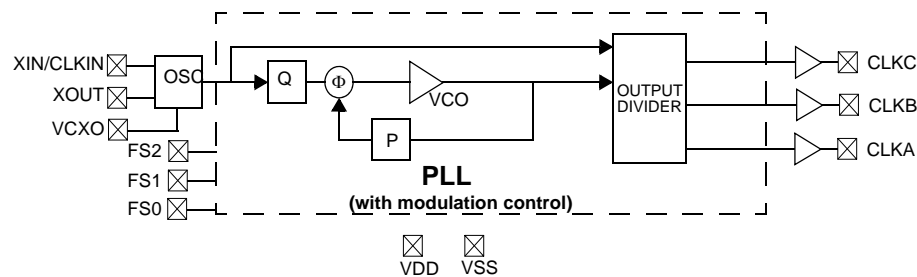

## Contents

|   |           |  |           |
|---|-----------|--|-----------|
| <b>Pin Configurations</b> .....                                     | <b>3</b>  | <b>Test Circuit</b> .....                            | <b>13</b> |
| <b>Pin Definitions</b> .....  | <b>3</b>  | <b>Timing Definitions</b> .....                      | <b>13</b> |
| <b>Spread Spectrum Clock Generation (SSCG)</b> .....                | <b>4</b>  | <b>Ordering Information</b> .....                    | <b>14</b> |
| <b>VCXO</b> .....   | <b>4</b>  | Ordering Code Definitions .....                      | 14        |
| VCXO Profile .....  | 4         | <b>Package Diagram</b> .....                         | <b>15</b> |
| <b>CY22800 Configurations</b> .....                                 | <b>5</b>  | <b>Acronyms</b> .....                                | <b>16</b> |
| <b>Cypress Programmable Clocks</b> .....                            | <b>10</b> | <b>Document Conventions</b> .....                    | <b>16</b> |
| <b>Absolute Maximum Conditions</b> .....                            | <b>11</b> | Units of Measure .....                               | 16        |
| <b>Recommended Operating Conditions</b> .....                       | <b>11</b> | <b>Document History Page</b> .....                   | <b>17</b> |
| <b>Pullable Crystal Specifications</b>                              |           | <b>Sales, Solutions, and Legal Information</b> ..... | <b>18</b> |
| <b>for VCXO Application ONLY</b> .....                              | <b>11</b> | Worldwide Sales and Design Support .....             | 18        |
| <b>Recommended Crystal Specifications</b>                           |           | Products .....                                       | 18        |
| <b>for ALL other Applications</b> .....                             | <b>12</b> | PSoC Solutions .....                                 | 18        |
| <b>DC Electrical Specifications</b> .....                           | <b>12</b> |  |           |
| <b>AC Electrical Characteristics (V<sub>DD</sub> = 3.3 V)</b> ..... | <b>12</b> |  |           |

## Pin Configurations

Figure 1. CY22800 8-Pin SOIC (150 Mils) Pinout

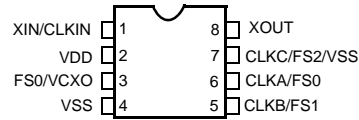

## Pin Definitions

| Name         | Pin Number | Description   |
|--------------|------------|---|
| XIN          | 1          | Reference input; crystal or external clock                    |
| VDD          | 2          | 3.3 V voltage supply  |
| FS0/VCXO     | 3          | Frequency select 0/VCXO analog control voltage <sup>[1]</sup> |
| VSS          | 4          | Ground  |
| CLKB/FS1     | 5          | Clock output B/frequency select 1 <sup>[1]</sup>              |
| CLKA/FS0     | 6          | Clock output A/frequency select 0 <sup>[1]</sup>              |
| CLKC/FS2/VSS | 7          | Clock output C/frequency select 2/VSS <sup>[1]</sup>          |
| XOUT         | 8          | Reference output (No Connect when the reference is a clock)   |

**Note**

1. Pin definition changes for different configurations. Refer to the specific one-page data sheet for more details.

### Spread Spectrum Clock Generation (SSCG)

The CY22800 can generate spread spectrum clocks (SSCG) to reduce EMI found in today's high-speed digital electronic systems.

The device uses proprietary spread spectrum clock (SSC) technology to synthesize and modulate the frequency of the input clock. By modulating the frequency of the clock, the measured EMI at the fundamental and harmonic frequencies is greatly reduced. This reduction in radiated energy can significantly reduce the cost of complying with regulatory agency (EMC) requirements and improve time to market without degrading system performance.

The CY22800 uses a preprogrammed configuration of memory arrays to synthesize output frequency and offers eight different spread percentages (refer to the [CY22800 Configurations on page 5](#) – Code numbers -015 to -022), and an additional option to turn the spread on and off.

For the above-mentioned configurations, the modulation frequency varies with the reference frequency as follows:

$$f_{\text{mod}} = \frac{f_{\text{ref}}}{1000}$$

### VCXO

One of the key components of the CY22800 device is the VCXO. The VCXO is used to "pull" the reference crystal higher or lower in order to lock the system frequency to an external source. This

is ideal for applications where the output frequency needs to track along with an external reference frequency that is constantly shifting.

A special pullable crystal must be used in order to have adequate VCXO pull range. Pullable Crystal specifications are included in this data sheet.

### VCXO Profile

Figure 2 shows an example of what a VCXO profile looks like. The analog voltage input is on the X-axis and the PPM range is on the Y-axis. An increase in the VCXO input voltage results in a corresponding increase in the output frequency. This has the effect of moving the PPM from a negative to positive offset.

Figure 2. VCXO Profile

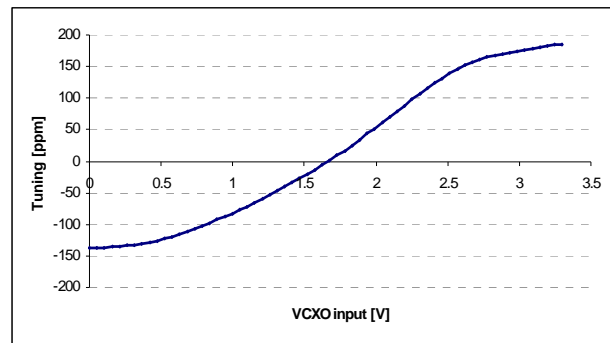

**CY22800 Configurations**

| Code #                              | Code name  | Input Freq. (MHz)              | Output Freq. (MHz)                                     | SS | VCXO |
|-------------------------------------|--|--------------------------------|--|----|------|
| <b>Commercial Temperature Range</b> |  |                                |  |    |      |
| CY22800-001A                        | X2 Multiplier  | CLKIN: 0.5–100<br>XTAL: 8–30   | CLKA: 1–200 or REFOUT                                  | N  | N    |
| CY22800-002A                        | X3 Multiplier  | CLKIN: 0.5–66.66<br>XTAL: 8–30 | CLKA: 1.5–200 or REFOUT                                | N  | N    |
| CY22800-003A                        | X4 Multiplier  | CLKIN: 0.5–50<br>XTAL: 8–30    | CLKA: 2–200 or REFOUT                                  | N  | N    |
| CY22800-004A                        | X5 Multiplier  | CLKIN: 0.5–40<br>XTAL: 8–30    | CLKA: 2.5–200 or REFOUT                                | N  | N    |
| CY22800-005A                        | X6 Multiplier  | CLKIN: 0.5–33.33<br>XTAL: 8–30 | CLKA: 3–200<br>CLKB: REFOUT                            | N  | N    |
| CY22800-006A                        | X8 Multiplier  | CLKIN: 0.5–25<br>XTAL: 8–25    | CLKA: 4–200<br>CLKB: REFOUT                            | N  | N    |
| CY22800-007A                        | Clock multiplier for consumer & communication applications | 14.318 <sup>[2]</sup>          | CLKA: 33.33, 66.66, 50, 75, 80, 100, 133.33<br>See D/S | N  | N    |
| CY22800-008A                        | Clock multiplier for consumer & communication applications | 14.318 <sup>[2]</sup>          | CLKA: 12, 24, 48, 60, 62.5, 106.25, 125<br>See D/S     | N  | N    |
| CY22800-009A                        | Clock multiplier for consumer & communication applications | 20 <sup>[2]</sup>              | CLKA: 33.33, 66.66, 50, 75, 80, 100, 133.33<br>See D/S | N  | N    |
| CY22800-010A                        | Clock multiplier for consumer & communication applications | 20 <sup>[2]</sup>              | CLKA: 12, 24, 48, 60, 62.5, 106.25, 125<br>See D/S     | N  | N    |
| CY22800-011A                        | Clock multiplier for consumer & communication applications | 25 <sup>[2]</sup>              | CLKA: 33.33, 66.66, 50, 75, 80, 100, 133.33<br>See D/S | N  | N    |
| CY22800-012A                        | Clock multiplier for consumer & communication applications | 25 <sup>[2]</sup>              | CLKA: 12, 24, 48, 60, 62.5, 106.25, 125<br>See D/S     | N  | N    |
| CY22800-013A                        | Clock multiplier for consumer & communication applications | 27 <sup>[2]</sup>              | CLKA: 33.33, 66.66, 50, 75, 80, 100, 133.33<br>See D/S | N  | N    |
| CY22800-014A                        | Clock multiplier for consumer & communication applications | 27 <sup>[2]</sup>              | CLKA: 12, 24, 48, 60, 62.5, 106.25, 125<br>See D/S     | N  | N    |

**Note**

2. Fixed CLKIN/Xtal frequency. Refer to the one page data sheet corresponding to the Code # for detailed input and output ranges.

**CY22800 Configurations** *(continued)*

| Code #       | Code name   | Input Freq. (MHz)                    | Output Freq. (MHz)  | SS | VCXO |
|--------------|---|--------------------------------------|---|----|------|
| CY22800-015A | Spread spectrum for consumer and communication applications   | CLKIN: 25.0–100.0<br>XTAL: 25.0–30.0 | CLKA: REF (spread $\pm 0.25\%$ or off)<br>CLKB: REF or REF/2 (spread $\pm 0.25\%$ or off) | Y  | N    |
| CY22800-016A | Spread spectrum for consumer and communication applications   | CLKIN: 25.0–100.0<br>XTAL: 25.0–30.1 | CLKA: REF (spread $\pm 0.5\%$ or off)<br>CLKB: REF or REF/2 (spread $\pm 0.5\%$ or off)   | Y  | N    |
| CY22800-017A | Spread spectrum for consumer and communication applications   | CLKIN: 25.0–100.0<br>XTAL: 25.0–30.0 | CLKA: REF (spread $\pm 0.75\%$ or off)<br>CLKB: REF or REF/2 (spread $\pm 0.75\%$ or off) | Y  | N    |
| CY22800-018A | Spread spectrum for consumer and communication applications   | CLKIN: 25.0–100.0<br>XTAL: 25.0–30.3 | CLKA: REF (spread $\pm 1.0\%$ or off)<br>CLKB: REF or REF/2 (spread $\pm 1.0\%$ or off)   | Y  | N    |
| CY22800-019A | Spread spectrum for consumer and communication applications   | CLKIN: 25.0–100.0<br>XTAL: 25.0–30.0 | CLKA: REF (spread $\pm 1.25\%$ or off)<br>CLKB: REF or REF/2 (spread $\pm 1.25\%$ or off) | Y  | N    |
| CY22800-020A | Spread spectrum for consumer and communication applications   | CLKIN: 25.0–100.0<br>XTAL: 25.0–30.0 | CLKA: REF (spread $\pm 1.5\%$ or off)<br>CLKB: REF or REF/2 (spread $\pm 1.5\%$ or off)   | Y  | N    |
| CY22800-021A | Spread spectrum for consumer and communication applications   | CLKIN: 25.0–100.0<br>XTAL: 25.0–30.1 | CLKA: REF (spread $\pm 1.75\%$ or off)<br>CLKB: REF or REF/2 (spread $\pm 1.75\%$ or off) | Y  | N    |
| CY22800-022A | Spread spectrum for consumer and communication applications   | CLKIN: 25.0–100.0<br>XTAL: 25.0–30.0 | CLKA: REF (spread $\pm 2.0\%$ or off)<br>CLKB: REF or REF/2 (spread $\pm 2.0\%$ or off)   | Y  | N    |
| CY22800-023A | MPEG-2 clock generator for DTV and STB w/ VCXO                | XTAL: 13.5                           | CLKA: 27<br>CLKB: 54<br>CLKC: 27  | N  | Y    |
| CY22800-024A | MPEG-2 clock generator for DTV and STB w/ VCXO                | XTAL: 13.5                           | CLKA: 13.5<br>CLKB: 54<br>CLKC: 27  | N  | Y    |
| CY22800-025A | MPEG-2 clock generator for DTV and STB w/ VCXO                | XTAL: 13.5/27.0 (Selectable)         | CLKB: 27, 27  | N  | Y    |
| CY22800-026A | MPEG-2 clock generator for DTV and STB w/ VCXO                | XTAL: 13.5/27.0 (Selectable)         | CLKB: 27, 27<br>CLKC: 27, 27  | N  | Y    |
| CY22800-027A | MPEG-2 clock generator for DTV and STB w/ VCXO                | XTAL: 27                             | CLKB: 27, 27<br>CLKC: 27, 27.027 (–1 ppm)   | N  | Y    |
| CY22800-028A | MPEG-2 clock generator for DTV and STB w/ VCXO                | XTAL: 27                             | CLKB: 27, 27<br>CLKC: 27, 27.027 (0 ppm)  | N  | Y    |
| CY22800-029A | HDTV, STB clock generator (USB/Ethernet/iLink clock)          | XTAL/CLKIN: 27                       | CLKA: 24.576, 25, 20, 48<br>CLKB: 27  | N  | N    |
| CY22800-030A | HDTV, STB clock generator (Ethernet/PCI/Microprocessor clock) | XTAL/CLKIN: 27                       | CLKA: 25, 20<br>CLKB: 27<br>CLKC: 33.33, 66.66  | N  | N    |
| CY22800-031A | HDTV, STB clock generator (PCI/Microprocessor clock)          | XTAL/CLKIN: 48                       | CLKA: 33.33, 66.66, 100, 133.33<br>CLKB: 48   | N  | N    |
| CY22800-032A | HDTV, STB clock generator (pixel clocks)                      | XTAL/CLKIN: 27                       | CLKA: 74.25, 74.175824, 148.5, 148.351648<br>CLKB: 27                                     | N  | N    |
| CY22800-033A | Audio clock generator for HDTV & STB (256fs)                  | XTAL/CLKIN: 27                       | CLKA: (32K, 44.1K, 48K) $\times$ 256<br>CLKB: 27  | N  | N    |

**CY22800 Configurations** *(continued)*

| Code #       | Code name  | Input Freq. (MHz)                 | Output Freq. (MHz)                                    | SS | VCXO |
|--------------|--|-----------------------------------|---|----|------|
| CY22800-034A | Audio clock generator for HDTV & STB (384fs)                   | XTAL/CLKIN: 27                    | CLKA: (32K, 44.1K, 48K) × 384<br>CLKB: 27             | N  | N    |
| CY22800-035A | Audio clock generator for HDTV & STB (512fs)                   | XTAL/CLKIN: 27                    | CLKA: (32K, 44.1K, 48K) × 512<br>CLKB: 27             | N  | N    |
| CY22800-036A | Audio clock generator for HDTV & STB (768fs)                   | XTAL/CLKIN: 27                    | CLKA: (32K, 44.1K, 48K) × 768<br>CLKB: 27             | N  | N    |
| CY22800-037A | Spread spectrum clock generator for PCI and ASIC               | XTAL/CLKIN: 14.31818              | CLKA: 33.33, 66.66, 100, 133.33<br>(-0.5% or off)     | Y  | N    |
| CY22800-038A | Spread spectrum clock generator for PCI and ASIC               | XTAL/CLKIN: 14.31818              | CLKA: 33.33, 66.66, 100, 133.33<br>(-1.0% or off)     | Y  | N    |
| CY22800-039A | Spread spectrum clock generator for PCI and ASIC               | XTAL/CLKIN: 14.31818              | CLKA: 33.33, 66.66, 100, 133.33<br>(±0.25% or off)    | Y  | N    |
| CY22800-040A | Spread spectrum clock generator for PCI and ASIC               | XTAL/CLKIN: 14.31818              | CLKA: 33.33, 66.66, 100, 133.33<br>(±0.5% or off)     | Y  | N    |
| CY22800-041A | Spread spectrum clock generator for Audio / Video Applications | XTAL/CLKIN: 27                    | CLKA: 33, 66 (spread -0.5% or off)<br>CLKB: 27        | Y  | N    |
| CY22800-042A | Spread spectrum clock generator for Audio / Video Applications | XTAL/CLKIN: 27                    | CLKA: 33, 66 (spread -1.0% or off)<br>CLKB: 27        | Y  | N    |
| CY22800-043A | Spread spectrum clock generator for Audio / Video Applications | XTAL/CLKIN: 27                    | CLKA: 33, 66 (spread ±0.25% or off)<br>CLKB: 27       | Y  | N    |
| CY22800-044A | Spread spectrum clock generator for Audio / Video Applications | XTAL/CLKIN: 27                    | CLKA: 33, 66 (spread ±0.5% or off)<br>CLKB: 27        | Y  | N    |
| CY22800-045A | Spread spectrum clock generator with Multiplier option         | CLKIN: 35–100                     | CLKA: ×1, ×2, ×4 or /2 (spread -0.5%)<br>CLKB: REFOUT | Y  | N    |
| CY22800-046A | Spread spectrum clock generator with Multiplier option         | CLKIN: 35–100                     | CLKA: ×1, ×2, ×4 or /2 (spread -1.0%)<br>CLKB: REFOUT | Y  | N    |
| CY22800-047A | Spread spectrum clock generator with Multiplier option         | CLKIN: 35–100                     | CLKA: ×1, ×2, ×4 or /2 (spread -1.5%)<br>CLKB: REFOUT | Y  | N    |
| CY22800-048A | Spread spectrum clock generator with Multiplier option         | CLKIN: 35–100                     | CLKA: ×1, ×2, ×4 or /2 (spread -2.0%)<br>CLKB: REFOUT | Y  | N    |
| CY22800-049A | Spread spectrum clock generator with Multiplier option         | CLKIN: 35–100                     | CLKA: ×1, ×2, ×4 or /2 (spread -2.5%)<br>CLKB: REFOUT | Y  | N    |
| CY22800-050A | Spread spectrum clock generator for PCI and ASIC               | XTAL/CLKIN: 14.31818              | CLKA: 33.33, 66.66, 100, 133.33<br>(-1.5% or off)     | Y  | N    |
| CY22800-051A | ×10 Multiplier   | CLKIN: 0.5–20<br>XTAL: 8–20       | CLKA: 5–200<br>CLKB: REFOUT                           | N  | N    |
| CY22800-052A | ×12 Multiplier   | CLKIN: 0.5–16.66<br>XTAL: 8–16.66 | CLKA: 6–200.0<br>CLKB: REFOUT                         | N  | N    |
| CY22800-053A | ×15 Multiplier   | CLKIN: 0.5–13.33<br>XTAL: 8–13.33 | CLKA: 7.5–200<br>CLKB: REFOUT                         | N  | N    |
| CY22800-054A | ×20 Multiplier   | CLKIN: 0.5–10<br>XTAL: 8–10       | CLKA: 10–200<br>CLKB: REFOUT                          | N  | N    |
| CY22800-055A | ×25 Multiplier   | CLKIN: 0.5–8<br>XTAL: 8           | CLKA: 12.5–200<br>CLKB: REFOUT                        | N  | N    |

**CY22800 Configurations** *(continued)*

| Code #       | Code name  | Input Freq. (MHz)            | Output Freq. (MHz)                                   | SS | VCXO |
|--------------|--|------------------------------|--|----|------|
| CY22800-056A | 2/3 Multiplier   | CLKIN: 2.5–133<br>XTAL: 8–30 | CLKA: 1.67–88.67<br>CLKB: REFOUT                     | N  | N    |
| CY22800-057A | 4/3 Multiplier   | CLKIN: 2–100<br>XTAL: 8–30   | CLKA: 2.66–133.33<br>CLKB: REFOUT                    | N  | N    |
| CY22800-058A | 3/4 Multiplier   | CLKIN: 3.5–133<br>XTAL: 8–30 | CLKA: 2.625–99.75<br>CLKB: REFOUT                    | N  | N    |
| CY22800-059A | 3/2 Multiplier   | CLKIN: 1.5–133<br>XTAL: 8–30 | CLKA: 2.25–199.5<br>CLKB: REFOUT                     | N  | N    |
| CY22800-060A | 2/5 Multiplier   | CLKIN: 5–133<br>XTAL: 8–30   | CLKA: 2–53.2<br>CLKB: REFOUT                         | N  | N    |
| CY22800-061A | 3/5 Multiplier   | CLKIN: 3.5–133<br>XTAL: 8–30 | CLKA: 2.1–80<br>CLKB: REFOUT                         | N  | N    |
| CY22800-062A | 5/6 Multiplier   | CLKIN: 3–80<br>XTAL: 8–30    | CLKA: 2.5–66.67<br>CLKB: REFOUT                      | N  | N    |
| CY22800-063A | 6/5 Multiplier   | CLKIN: 2–66.67<br>XTAL: 8–30 | CLKA: 2.4–80<br>CLKB: REFOUT                         | N  | N    |
| CY22800-064A | 5/8 Multiplier   | CLKIN: 2.5–80<br>XTAL: 8–30  | CLKA: 1.56–50<br>CLKB: REFOUT                        | N  | N    |
| CY22800-065A | 8/5 Multiplier   | CLKIN: 2–50<br>XTAL: 8–30    | CLKA: 3.2–80<br>CLKB: REFOUT                         | N  | N    |
| CY22800-066A | Spread spectrum clock generator for Audio / Video Applications | XTAL/CLKIN: 27               | CLKA: 33, 66 (spread –1.5% or off)<br>CLKB: 27       | Y  | N    |
| CY22800-067A | 5/4 Multiplier   | CLKIN: 5–133<br>XTAL: 8–30   | CLKA: 6–166<br>CLKB: REFOUT                          | N  | N    |
| CY22800-068A | 4/5 Multiplier   | CLKIN: 5–33<br>XTAL: 8–30    | CLKA: 4–106<br>CLKB: REFOUT                          | N  | N    |
| CY22800-069A | 66/64 Multiplier   | CLKIN: 5–133<br>XTAL: 8–30   | CLKA: 5–137<br>CLKB: REFOUT                          | N  | N    |
| CY22800-070A | 64/66 Multiplier   | CLKIN: 5–133<br>XTAL: 8–30   | CLKA: 5–129<br>CLKB: REFOUT                          | N  | N    |
| CY22800-071A | 255/238 Multiplier   | CLKIN: 5–133<br>XTAL: 8–30   | CLKA: 5–142<br>CLKB: REFOUT                          | N  | N    |
| CY22800-072A | 238/255 Multiplier   | CLKIN: 5–133<br>XTAL: 8–30   | CLKA: 5–124<br>CLKB: REFOUT                          | N  | N    |
| CY22800-073A | 3-Output Fanout Buffer   | CLKIN: 1–133<br>XTAL: 8–30   | CLKA = CLKB = CLKC: REFOUT                           | N  | N    |
| CY22800-074A | X2 Multiplier with Fanout and REFOUT                           | CLKIN: 9–100<br>XTAL: 9–30   | CLKA = CLKC: 18–200<br>CLKB: REFOUT                  | N  | N    |
| CY22800-075A | X3 Multiplier with Fanout and REFOUT                           | CLKIN: 6–66<br>XTAL: 8–30    | CLKA = CLKC: 18–200<br>CLKB: REFOUT                  | N  | N    |
| CY22800-076A | X4 Multiplier with Fanout and REFOUT                           | CLKIN: 5–50<br>XTAL: 8–30    | CLKA = CLKC: 20–200<br>CLKB: REFOUT                  | N  | N    |
| CY22800-077A | /2 Clock Divider   | CLKIN: 0.5–133<br>XTAL: 8–30 | CLKA: 0.25–66.5<br>CLKB = CLKC: 0.25–66.5 or off     | N  | N    |
| CY22800-078A | /3 Clock Divider   | CLKIN: 0.5–133<br>XTAL: 8–30 | CLKA: 0.17–44.3<br>CLKB = CLKC: 0.17–44.3 or off     | N  | N    |
| CY22800-079A | /4 Clock Divider   | CLKIN: 0.5–133<br>XTAL: 8–30 | CLKA: 0.125–33.25<br>CLKB = CLKC: 0.125–33.25 or off | N  | N    |
| CY22800-080A | /5 Clock Divider   | CLKIN: 0.5–133<br>XTAL: 8–30 | CLKA: 0.1–26.6<br>CLKB = CLKC: 0.1–26.6 or off       | N  | N    |



**CY22800 Configurations** *(continued)*

| Code #                              | Code name   | Input Freq. (MHz)                 | Output Freq. (MHz)  | SS | VCXO |
|-------------------------------------|---|-----------------------------------|---|----|------|
| CY22800-081A                        | /6 Clock Divider  | CLKIN: 0.5–133<br>XTAL: 8–30      | CLKA: 0.083–22.2<br>CLKB = CLKC: 0.083–22.2 or off  | N  | N    |
| CY22800-082A                        | /7 Clock Divider  | CLKIN: 0.5–133<br>XTAL: 8–30      | CLKA: 0.071–19<br>CLKB = CLKC: 0.071–19 or off  | N  | N    |
| CY22800-083A                        | /8 Clock Divider  | CLKIN: 0.5–133<br>XTAL: 8–30      | CLKA: 0.063–16.6<br>CLKB = CLKC: 0.063–v16.6 or off                                       | N  | N    |
| CY22800-084A                        | /9 Clock Divider  | CLKIN: 0.5–133<br>XTAL: 8–30      | CLKA: 0.056–14.8<br>CLKB = CLKC: 0.056–14.8 or off  | N  | N    |
| CY22800-085A                        | /10 Clock Divider   | CLKIN: 0.5–133<br>XTAL: 8–30      | CLKA: 0.05–13.3<br>CLKB = CLKC: 0.05–13.3 or off  | N  | N    |
| <b>Industrial Temperature Range</b> |   |                                   |   |    |      |
| CY22800-115A                        | Spread spectrum for consumer and communication applications | CLKIN: 25– 82.5<br>XTAL: 25–30    | CLKA: REF (spread $\pm 0.25\%$ or off)<br>CLKB: REF or REF/2 (spread $\pm 0.25\%$ or off) | Y  | N    |
| CY22800-116A                        | Spread spectrum for consumer and communication applications | CLKIN: 25–82.5<br>XTAL: 25–30     | CLKA: REF (spread $\pm 0.5\%$ or off)<br>CLKB: REF or REF/2 (spread $\pm 0.5\%$ or off)   | Y  | N    |
| CY22800-117A                        | Spread spectrum for consumer and communication applications | CLKIN: 25–82.5<br>XTAL: 25 - 30   | CLKA: REF (spread $\pm 0.75\%$ or off)<br>CLKB: REF or REF/2 (spread $\pm 0.75\%$ or off) | Y  | N    |
| CY22800-118A                        | Spread spectrum for consumer and communication applications | CLKIN: 25–82.5<br>XTAL: 25–30     | CLKA: REF (spread $\pm 1.0\%$ or off)<br>CLKB: REF or REF/2 (spread $\pm 1.0\%$ or off)   | Y  | N    |
| CY22800-119A                        | Spread spectrum for consumer and communication applications | CLKIN: 25–82.5<br>XTAL: 25–30     | CLKA: REF (spread $\pm 1.25\%$ or off)<br>CLKB: REF or REF/2 (spread $\pm 1.25\%$ or off) | Y  | N    |
| CY22800-120A                        | Spread spectrum for consumer and communication applications | CLKIN: 25–82.5<br>XTAL: 25–30     | CLKA: REF (spread $\pm 1.5\%$ or off)<br>CLKB: REF or REF/2 (spread $\pm 1.5\%$ or off)   | Y  | N    |
| CY22800-121A                        | Spread spectrum for consumer and communication applications | CLKIN: 25–82.5<br>XTAL: 25–30     | CLKA: REF (spread $\pm 1.75\%$ or off)<br>CLKB: REF or REF/2 (spread $\pm 1.75\%$ or off) | Y  | N    |
| CY22800-145A                        | Spread spectrum clock generator with Multiplier option      | CLKIN: 35–82.5                    | CLKA: $\times 1, \times 2, \times 4$ or /2 (spread $-0.5\%$ )<br>CLKB: REFOUT             | Y  | N    |
| CY22800-146A                        | Spread spectrum clock generator with Multiplier option      | CLKIN: 35–82.5                    | CLKA: $\times 1, \times 2, \times 4$ or /2 (spread $-1.0\%$ )<br>CLKB: REFOUT             | Y  | N    |
| CY22800-147A                        | Spread spectrum clock generator with Multiplier option      | CLKIN: 35–82.5                    | CLKA: $\times 1, \times 2, \times 4$ or /2 (spread $-1.5\%$ )<br>CLKB: REFOUT             | Y  | N    |
| CY22800-148A                        | Spread spectrum clock generator with Multiplier option      | CLKIN: 35–82.5                    | CLKA: $\times 1, \times 2, \times 4$ or /2 (spread $-2.0\%$ )<br>CLKB: REFOUT             | Y  | N    |
| CY22800-151A                        | $\times 10$ Multiplier                                      | CLKIN: 0.5–16.5<br>XTAL: 8–16.5   | CLKA: 5–165<br>CLKB: REFOUT   | N  | N    |
| CY22800-152A                        | $\times 12$ Multiplier                                      | CLKIN: 0.5–13.75<br>XTAL: 8–13.75 | CLKA: 6–165<br>CLKB: REFOUT   | N  | N    |
| CY22800-153A                        | $\times 15$ Multiplier                                      | CLKIN: 0.5–11<br>XTAL: 8–11       | CLKA: 7.5–165<br>CLKB: REFOUT   | N  | N    |

**CY22800 Configurations** (continued)

| Code #       | Code name      | Input Freq. (MHz)               | Output Freq. (MHz)               | SS | VCXO |
|--------------|----------------|---------------------------------|----------------------------------|----|------|
| CY22800-154A | x20 Multiplier | CLKIN: 0.5–8.25<br>XTAL: 8–8.25 | CLKA: 10–165<br>CLKB: REFOUT     | N  | N    |
| CY22800-155A | x25 Multiplier | CLKIN: 0.5–6.6<br>XTAL: 8–6.6   | CLKA: 12.5–165<br>CLKB: REFOUT   | N  | N    |
| CY22800-156A | 2/3 Multiplier | CLKIN: 2.5–82.5<br>XTAL: 8–30   | CLKA: 1.67–55<br>CLKB: REFOUT    | N  | N    |
| CY22800-157A | 4/3 Multiplier | CLKIN: 1.5–82.5<br>XTAL: 8–27.5 | CLKA: 2–110<br>CLKB: REFOUT      | N  | N    |
| CY22800-158A | 3/4 Multiplier | CLKIN: 3.5–110<br>XTAL: 8–30    | CLKA: 2.625–82.5<br>CLKB: REFOUT | N  | N    |
| CY22800-159A | 3/2 Multiplier | CLKIN: 1.5–110<br>XTAL: 8–27.5  | CLKA: 2.25–165<br>CLKB: REFOUT   | N  | N    |
| CY22800-160A | 2/5 Multiplier | CLKIN: 5–133<br>XTAL: 8–30      | CLKA: 2–53.2<br>CLKB: REFOUT     | N  | N    |
| CY22800-161A | 3/5 Multiplier | CLKIN: 3.5–110<br>XTAL: 8–30    | CLKA: 2.1–66<br>CLKB: REFOUT     | N  | N    |
| CY22800-162A | 5/6 Multiplier | CLKIN: 3–66<br>XTAL: 8–30       | CLKA: 2.5–55<br>CLKB: REFOUT     | N  | N    |
| CY22800-163A | 6/5 Multiplier | CLKIN: 2–55<br>XTAL: 8–30       | CLKA: 2.4–66<br>CLKB: REFOUT     | N  | N    |
| CY22800-164A | 5/8 Multiplier | CLKIN: 2.5–80<br>XTAL: 8–30     | CLKA: 1.56–50<br>CLKB: REFOUT    | N  | N    |
| CY22800-165A | 8/5 Multiplier | CLKIN: 2–41.25<br>XTAL: 8–30    | CLKA: 3.2–66<br>CLKB: REFOUT     | N  | N    |

Cypress offers a wide range of programmable clock synthesizers that can be used to generate any other frequencies not covered by the CY22800. [Cypress Programmable Clocks](#) summarizes all Cypress programmable devices including CY22800.

**Cypress Programmable Clocks**

| Part # <sup>[3]</sup> | No. of PLL | Input Freq. | Output Freq. | Package                                       | No. of Outputs | Spread Spectrum | VCXO | I <sup>2</sup> C |
|-----------------------|------------|-------------|--------------|---|----------------|-----------------|------|------------------|
| CY22800               | 1          | 0.5–100     | up to 200    | 8-pin SOIC                                    | up to 3        | Yes             | Yes  | No               |
| CY22801               | 1          | 0.5–133     | up to 200    | 8-pin SOIC                                    | up to 3        | No              | No   | No               |
| CY22050               | 1          | 1–133       | 0.08–200     | 16-pin TSSOP                                  | up to 6        | No              | No   | No               |
| CY22150               | 1          | 1–133       | 0.08–200     | 16-pin TSSOP                                  | up to 6        | No              | No   | Yes              |
| CY25100               | 1          | 8–166       | 3–200        | 8-pin SOIC /<br>8-pin TSSOP                   | up to 2        | Yes             | No   | No               |
| CY25200               | 1          | 3–166       | 3–200        | 16-pin TSSOP                                  | up to 6        | Yes             | No   | No               |
| CY241V08              | 1          | 27/13.5     | 27/13.5      | 8-pin SOIC                                    | up to 2        | No              | Yes  | No               |
| CY22392               | 3          | 1–166       | up to 200    | 16-pin TSSOP                                  | up to 6        | No              | No   | No               |
| CY22381               | 3          | 1–166       | up to 200    | 8-pin SOIC                                    | up to 3        | No              | No   | No               |
| CY22393               | 3          | 1–166       | up to 200    | 16-pin TSSOP                                  | up to 6        | No              | No   | Yes              |
| CY22394/5             | 3          | 1–166       | up to 200    | 16-pin TSSOP                                  | up to 5        | No              | No   | No               |
| CY22388/89/91         | 4          | 1–100       | 1–166        | 16-pin TSSOP /<br>20-pin TSSOP,<br>32-pin QFN | up to 8        | No              | Yes  | No               |

**Note**

3. CY3672 can be used to program the clock devices listed in [Cypress Programmable Clocks](#).

### Absolute Maximum Conditions

| Parameter       | Description                                 | Min                   | Max                   | Unit |
|-----------------|---|-----------------------|-----------------------|------|
| V <sub>DD</sub> | Supply voltage                              | -0.5                  | 4.6                   | V    |
| T <sub>S</sub>  | Storage temperature                         | -65                   | 125                   | °C   |
| T <sub>J</sub>  | Junction temperature                        | -                     | 125                   | °C   |
|                 | Digital inputs                              | V <sub>SS</sub> - 0.3 | V <sub>DD</sub> + 0.3 | V    |
|                 | Digital outputs referred to V <sub>DD</sub> | V <sub>SS</sub> - 0.3 | V <sub>DD</sub> + 0.3 | V    |
|                 | Electro-static discharge                    | 2                     | -                     | kV   |

### Recommended Operating Conditions

| Parameter                       | Description   | Min  | Typ | Max  | Unit |
|---------------------------------|---|------|-----|------|------|
| V <sub>DD</sub>                 | Operating voltage   | 3.14 | 3.3 | 3.47 | V    |
| T <sub>A</sub>                  | Ambient temperature, commercial grade   | 0    | -   | 70   | °C   |
|                                 | Ambient temperature, industrial grade   | -40  | -   | 85   | °C   |
| C <sub>LOAD</sub>               | Max. load capacitance on the CLK output   | -    | -   | 15   | pF   |
| f <sub>REF</sub> <sup>[4]</sup> | Reference frequency   | 0.5  | -   | 100  | MHz  |
| t <sub>PU</sub>                 | Power up time for all V <sub>DDs</sub> to reach minimum specified voltage (power ramps must be monotonic) | 0.05 | -   | 500  | ms   |

### Pullable Crystal Specifications for VCXO Application Only

| Parameter                      | Name   | Min  | Typ | Max  | Unit |
|--------------------------------|--|------|-----|------|------|
| C <sub>LNOM</sub>              | Crystal load capacitance   | -    | 14  | -    | pF   |
| R <sub>1</sub>                 | Equivalent series resistance   | -    | -   | 25   | Ω    |
| R <sub>3</sub> /R <sub>1</sub> | Ratio of third overtone mode ESR to Fundamental Mode ESR. Ratio used because typical R <sub>1</sub> values are much less than the maximum spec | 3    | -   | -    | -    |
| DL                             | Crystal drive level. No external series resistor assumed   | -    | 0.5 | 2    | mW   |
| F <sub>3SEPHI</sub>            | Third overtone separation from 3 × F <sub>NOM</sub> (High Side)  | 300  | -   | -    | ppm  |
| F <sub>3SEPLO</sub>            | Third overtone separation from 3 × F <sub>NOM</sub> (Low Side)   | -    | -   | -150 | ppm  |
| C <sub>0</sub>                 | Crystal shunt capacitance  | -    | -   | 7    | pF   |
| C <sub>0</sub> /C <sub>1</sub> | Ratio of Shunt to motional capacitance   | 180  | -   | 250  |      |
| C <sub>1</sub>                 | Crystal motional capacitance   | 14.4 | 18  | 21.6 | fF   |

**Note**

4. Configuration dependent, see the one-page documents.

**Recommended Crystal Specifications for All other Applications**

| Parameter         | Name                               | Description                                      | Min | Typ | Max | Unit |
|-------------------|------------------------------------|--|-----|-----|-----|------|
| F <sub>NOM</sub>  | Nominal crystal frequency          | Parallel resonance, fundamental mode, and AT cut | 8   | –   | 30  | MHz  |
| C <sub>LNOM</sub> | Nominal load capacitance           |  | –   | 12  | –   | pF   |
| R <sub>1</sub>    | Equivalent series resistance (ESR) | Fundamental mode                                 | –   | 35  | 50  | Ω    |
| DL                | Crystal drive level                | No external series resistor assumed              | –   | 0.5 | 2   | mW   |

**DC Electrical Specifications**

| Parameter         | Name                   | Description  | Min  | Typ | Max             | Unit            |
|-------------------|------------------------|--|------|-----|-----------------|-----------------|
| I <sub>OH</sub>   | Output high current    | V <sub>OH</sub> = V <sub>DD</sub> – 0.5 V,<br>V <sub>DD</sub> = 3.3 V (source) | 12   | 24  | –               | mA              |
| I <sub>OL</sub>   | Output low current     | V <sub>OL</sub> = 0.5 V, V <sub>DD</sub> = 3.3 V (sink)                        | 12   | 24  | –               | mA              |
| C <sub>IN1</sub>  | Input capacitance      | All input pins except XIN and XOUT   | –    | –   | 7               | pF              |
| C <sub>IN2</sub>  | Input capacitance      | XIN and XOUT pins for non-VCXO applications                                    | –    | 24  | –               | pF              |
| I <sub>IH</sub>   | Input high current     | V <sub>IH</sub> = V <sub>DD</sub>  | –    | 5   | 10              | μA              |
| I <sub>IL</sub>   | Input low current      | V <sub>IL</sub> = 0 V  | –    | –   | 50              | μA              |
| f <sub>ΔXO</sub>  | VCXO pullability range |  | ±150 | –   | –               | ppm             |
| V <sub>VCXO</sub> | VCXO input range       |  | 0    | –   | V <sub>DD</sub> | V               |
| V <sub>IH</sub>   | Input high voltage     | CMOS levels, 70% of V <sub>DD</sub>  | 0.7  | –   | –               | V <sub>DD</sub> |
| V <sub>IL</sub>   | Input low voltage      | CMOS levels, 30% of V <sub>DD</sub>  | –    | –   | 0.3             | V <sub>DD</sub> |

**AC Electrical Characteristics (V<sub>DD</sub> = 3.3 V)**

| Parameter       | Name                   | Description  | Min | Typ | Max | Unit |
|-----------------|------------------------|--|-----|-----|-----|------|
| DC              | Output duty cycle      | Duty cycle is defined in <a href="#">Figure 4</a> , 50% of V <sub>DD</sub> | 45  | 50  | 55  | %    |
| t <sub>3</sub>  | Rising edge slew rate  | Output clock rise time, 20%–80% of V <sub>DD</sub>                         | 0.8 | 1.4 | –   | V/ns |
| t <sub>4</sub>  | Falling edge slew rate | Output clock fall time, 80%–20% of V <sub>DD</sub>                         | 0.8 | 1.4 | –   | V/ns |
| t <sub>10</sub> | PLL Lock Time          |  | –   | –   | 3   | ms   |

**Test Circuit**

**Figure 3. Test Circuit Diagram**

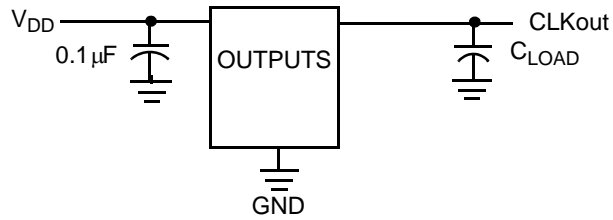

**Timing Definitions**

**Figure 4. Duty Cycle Definition;  $DC = t2/t1$**

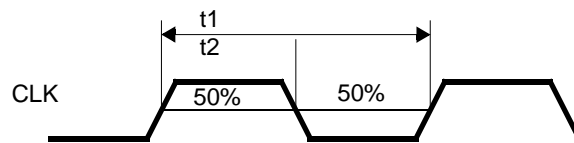

**Figure 5. Rise and Fall Time Definitions**

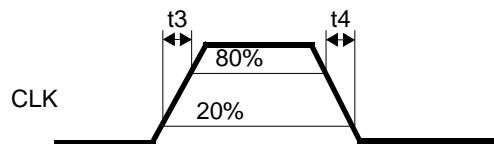

**Ordering Information**

| Ordering Code | Package Type               | Operating Range | Operating Voltage |
|---------------|----------------------------|-----------------|-------------------|
| CY22800KFXC   | 8-pin SOIC                 | Commercial      | 3.3 V             |
| CY22800KFXCT  | 8-pin SOIC – Tape and Reel | Commercial      | 3.3 V             |
| CY22800KFXI   | 8-pin SOIC                 | Industrial      | 3.3 V             |
| CY22800KFXIT  | 8-pin SOIC – Tape and Reel | Industrial      | 3.3 V             |

**Ordering Code Definitions**

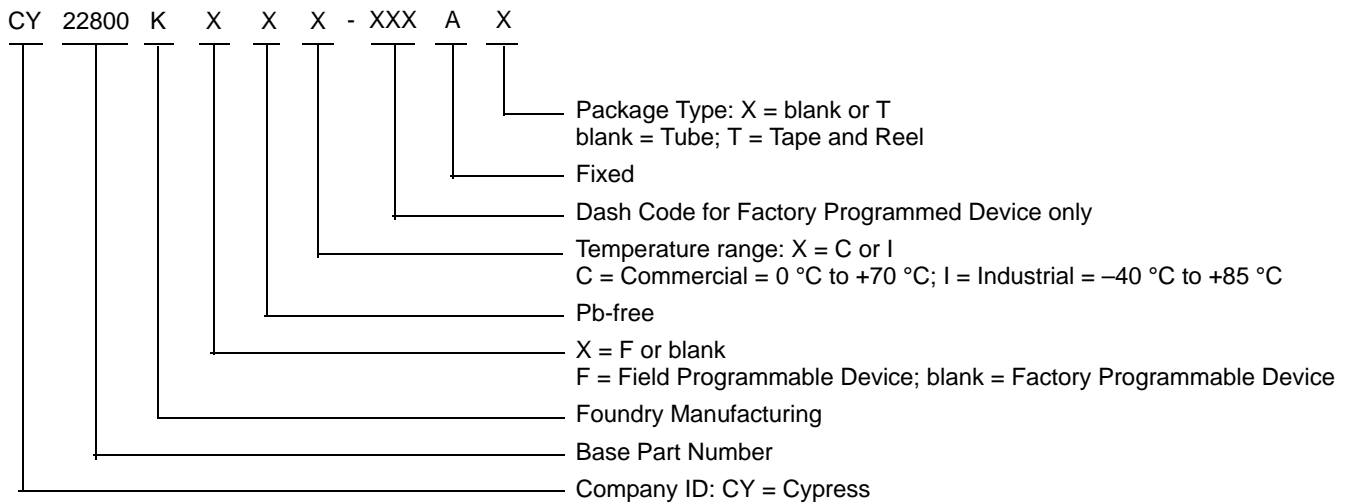

Package Diagram

Figure 6. 8-pin SOIC (150 Mils) S08.15/SZ08.15 Package Outline, 51-85066

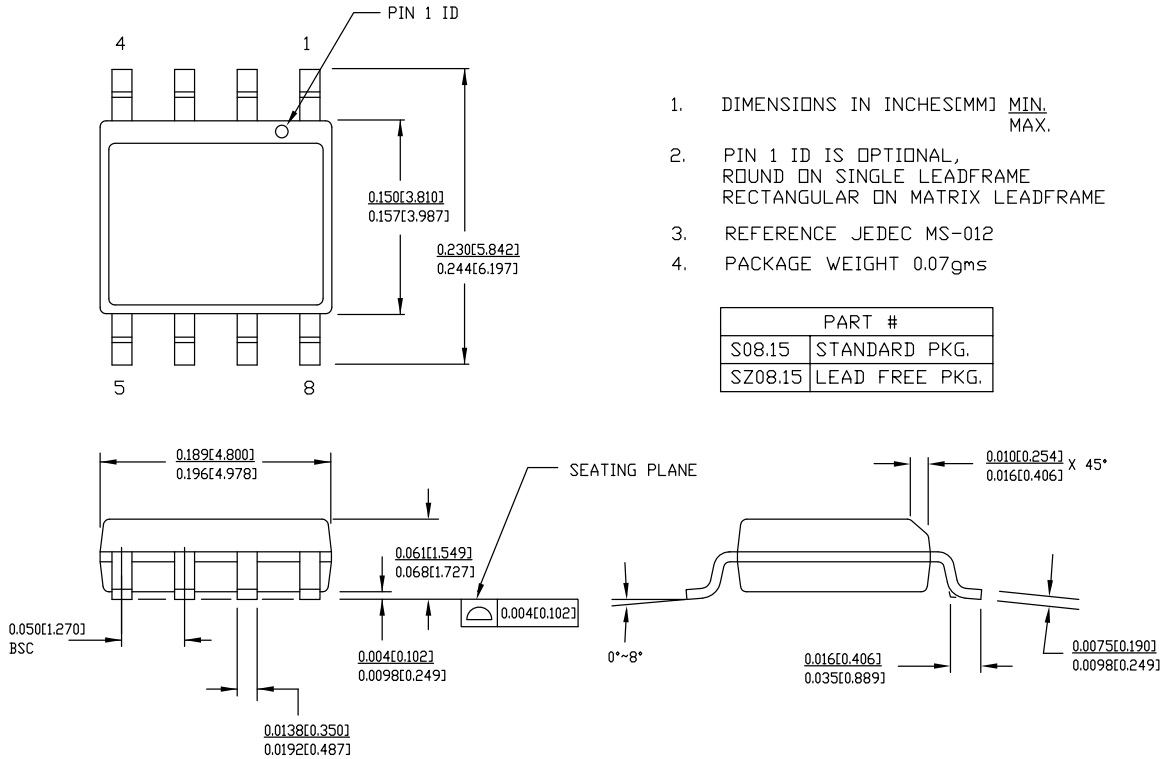

1. DIMENSIONS IN INCHES[MM] MIN. MAX.
2. PIN 1 ID IS OPTIONAL, ROUND ON SINGLE LEADFRAME RECTANGULAR ON MATRIX LEADFRAME
3. REFERENCE JEDEC MS-012
4. PACKAGE WEIGHT 0.07gms

| PART #  |                |
|---------|----------------|
| S08.15  | STANDARD PKG.  |
| SZ08.15 | LEAD FREE PKG. |

51-85066 \*F

## Acronyms

Table 1. Acronyms used in this Document

| Acronym | Description                             |
|---------|---|
| ASIC    | application-specific integrated circuit |
| CMOS    | complementary metal oxide semiconductor |
| DTV     | digital television                      |
| EMC     | electromagnetic compatibility           |
| EMI     | electromagnetic interference            |
| ESR     | equivalent series resistance            |
| HDTV    | high-definition television              |
| PCI     | peripheral component interface          |
| PLL     | phase-locked loop                       |
| QFN     | quad flat no-lead                       |
| SOIC    | small outline integrated circuit        |
| SSC     | supervisory system call                 |
| SSCG    | spread spectrum clock generator         |
| STB     | set-top box                             |
| TSSOP   | thin-shrink small outline package       |
| UPCG    | universal programmable clock generator  |
| VCXO    | voltage controlled crystal oscillator   |

## Document Conventions

### Units of Measure

Table 2. Units of Measure

| Symbol | Unit of Measure   |
|--------|-------------------|
| °C     | degree Celsius    |
| fF     | femtofarad        |
| kV     | kilovolt          |
| MHz    | megahertz         |
| μA     | microampere       |
| μF     | microfarad        |
| mA     | milliampere       |
| ms     | millisecond       |
| mW     | milliwatt         |
| ns     | nanosecond        |
| Ω      | ohm               |
| ppm    | parts per million |
| %      | percent           |
| pF     | picofarad         |
| V      | volt              |



Document History Page

| Document Title: CY22800, Universal Programmable Clock Generator (UPCG) |         |                 |                 |  |
|--|---------|-----------------|-----------------|--|
| Document Number: 001-07704   |         |                 |                 |  |
| Rev.   | ECN No. | Orig. of Change | Submission Date | Description of Change  |
| **   | 478688  | KKVTMP          | 07/10/2006      | New data sheet   |
| *A   | 1063800 | KKVTMP          | 05/20/2007      | Updated <a href="#">Features</a> (Added Industrial Temperature information).<br>Updated <a href="#">Functional Description</a> (Updated the sentence to read as “The CY22800 is a reprogrammable device that can be programmed up to 100 times.”).<br>Updated <a href="#">CY22800 Configurations</a> (Added Industrial Temperature information and also some more codes and their respective details).<br>Updated <a href="#">Cypress Programmable Clocks</a> (Added CY22801 and its details).<br>Updated <a href="#">Recommended Operating Conditions</a> (Added Industrial Temperature information).<br>Updated <a href="#">Pullable Crystal Specifications for VCXO Application ONLY</a> (Changed unit for C <sub>1</sub> parameter from pF to fF).<br>Updated <a href="#">Ordering Information</a> (Added Industrial Temperature information). |
| *B   | 2440628 | AESA            | 05/25/2008      | Updated Note 3.<br>Added part numbers CY22800FXCT, CY22800FXIT, CY22800KFXC, CY22800KFXCT, CY22800KFXI, and CY22800KFXIT in <a href="#">Ordering Information</a> .<br>Added Note “Not recommended for new designs.” below <a href="#">Ordering Information</a> .<br>Updated template.  |
| *C   | 2897294 | KVM             | 03/22/2010      | Removed part numbers CY22800FXC, CY22800FXCT, CY22800FXI and CY22800FXIT from the <a href="#">Ordering Information</a> .<br>Removed Note “Not recommended for new designs.” below <a href="#">Ordering Information</a> .<br>Updated <a href="#">Package Diagram</a> .<br>Updated copyright section.  |
| *D   | 3349379 | PURU            | 08/26/2011      | Removed Benefits section on page 1.<br>Updated <a href="#">Package Diagram</a> .<br>Added <a href="#">Ordering Code Definitions</a> .<br>Added <a href="#">Acronyms</a> and <a href="#">Units of Measure</a> .   |
| *E   | 3471796 | PURU            | 12/21/2011      | Replaced all instances of CYTRA-102004-00 with CY22800 across the document.  |
| *F   | 4491759 | XHT             | 9/8/2014        | Sunset review,<br>updated package revision   |
| *G   | 4576237 | XHT             | 11/21/2014      | Added related documentation hyperlink in page 1.<br>Updated the Output Frequency for the following parts in <a href="#">Cypress Programmable Clocks</a> table: CY22800, CY22801, CY22392, CY22381, CY22393, CY22394/5, and CY22388/89/91.  |

## Sales, Solutions, and Legal Information

### Worldwide Sales and Design Support

Cypress maintains a worldwide network of offices, solution centers, manufacturer's representatives, and distributors. To find the office closest to you, visit us at [Cypress Locations](#).

### Products

|  |  |
|--|--|
| <a href="#">Automotive</a>                   | <a href="http://cypress.com/go/automotive">cypress.com/go/automotive</a>   |
| <a href="#">Clocks &amp; Buffers</a>         | <a href="http://cypress.com/go/clocks">cypress.com/go/clocks</a>   |
| <a href="#">Interface</a>                    | <a href="http://cypress.com/go/interface">cypress.com/go/interface</a>   |
| <a href="#">Lighting &amp; Power Control</a> | <a href="http://cypress.com/go/powerpsoc">cypress.com/go/powerpsoc</a><br><a href="http://cypress.com/go/plc">cypress.com/go/plc</a> |
| <a href="#">Memory</a>                       | <a href="http://cypress.com/go/memory">cypress.com/go/memory</a>   |
| <a href="#">Optical &amp; Image Sensing</a>  | <a href="http://cypress.com/go/image">cypress.com/go/image</a>   |
| <a href="#">PSoC</a>                         | <a href="http://cypress.com/go/psoc">cypress.com/go/psoc</a>   |
| <a href="#">Touch Sensing</a>                | <a href="http://cypress.com/go/touch">cypress.com/go/touch</a>   |
| <a href="#">USB Controllers</a>              | <a href="http://cypress.com/go/USB">cypress.com/go/USB</a>   |
| <a href="#">Wireless/RF</a>                  | <a href="http://cypress.com/go/wireless">cypress.com/go/wireless</a>   |

### PSoC Solutions

[psoc.cypress.com/solutions](http://psoc.cypress.com/solutions)  
PSoC 1 | PSoC 3 | PSoC 5

---

© Cypress Semiconductor Corporation, 2006-2014. The information contained herein is subject to change without notice. Cypress Semiconductor Corporation assumes no responsibility for the use of any circuitry other than circuitry embodied in a Cypress product. Nor does it convey or imply any license under patent or other rights. Cypress products are not warranted nor intended to be used for medical, life support, life saving, critical control or safety applications, unless pursuant to an express written agreement with Cypress. Furthermore, Cypress does not authorize its products for use as critical components in life-support systems where a malfunction or failure may reasonably be expected to result in significant injury to the user. The inclusion of Cypress products in life-support systems application implies that the manufacturer assumes all risk of such use and in doing so indemnifies Cypress against all charges.

Any Source Code (software and/or firmware) is owned by Cypress Semiconductor Corporation (Cypress) and is protected by and subject to worldwide patent protection (United States and foreign), United States copyright laws and international treaty provisions. Cypress hereby grants to licensee a personal, non-exclusive, non-transferable license to copy, use, modify, create derivative works of, and compile the Cypress Source Code and derivative works for the sole purpose of creating custom software and or firmware in support of licensee product to be used only in conjunction with a Cypress integrated circuit as specified in the applicable agreement. Any reproduction, modification, translation, compilation, or representation of this Source Code except as specified above is prohibited without the express written permission of Cypress.

Disclaimer: CYPRESS MAKES NO WARRANTY OF ANY KIND, EXPRESS OR IMPLIED, WITH REGARD TO THIS MATERIAL, INCLUDING, BUT NOT LIMITED TO, THE IMPLIED WARRANTIES OF MERCHANTABILITY AND FITNESS FOR A PARTICULAR PURPOSE. Cypress reserves the right to make changes without further notice to the materials described herein. Cypress does not assume any liability arising out of the application or use of any product or circuit described herein. Cypress does not authorize its products for use as critical components in life-support systems where a malfunction or failure may reasonably be expected to result in significant injury to the user. The inclusion of Cypress' product in a life-support systems application implies that the manufacturer assumes all risk of such use and in doing so indemnifies Cypress against all charges.

Use may be limited by and subject to the applicable Cypress software license agreement.

Компания «Life Electronics» занимается поставками электронных компонентов импортного и отечественного производства от производителей и со складов крупных дистрибьюторов Европы, Америки и Азии.

С конца 2013 года компания активно расширяет линейку поставок компонентов по направлению коаксиальный кабель, кварцевые генераторы и конденсаторы (керамические, пленочные, электролитические), за счёт заключения дистрибьюторских договоров

Мы предлагаем:

- Конкурентоспособные цены и скидки постоянным клиентам.
- Специальные условия для постоянных клиентов.
- Подбор аналогов.
- Поставку компонентов в любых объемах, удовлетворяющих вашим потребностям.
- Приемлемые сроки поставки, возможна ускоренная поставка.
- Доставку товара в любую точку России и стран СНГ.
- Комплексную поставку.
- Работу по проектам и поставку образцов.
- Формирование склада под заказчика.
- Сертификаты соответствия на поставляемую продукцию (по желанию клиента).
- Тестирование поставляемой продукции.
- Поставку компонентов, требующих военную и космическую приемку.
- Входной контроль качества.
- Наличие сертификата ISO.

В составе нашей компании организован Конструкторский отдел, призванный помогать разработчикам, и инженерам.

Конструкторский отдел помогает осуществить:

- Регистрацию проекта у производителя компонентов.
- Техническую поддержку проекта.
- Защиту от снятия компонента с производства.
- Оценку стоимости проекта по компонентам.
- Изготовление тестовой платы монтаж и пусконаладочные работы.



Тел: +7 (812) 336 43 04 (многоканальный)

Email: [org@lifeelectronics.ru](mailto:org@lifeelectronics.ru)