

Contact Detail:
520-P.C. Tail .025x.024(0.64x0.61) - Tail LG.=.215(5.46)

THIS IS A C.A.D. GENERATED DRAWING
 DO NOT MAKE MANUAL REVISIONS TO MASTER.



ISSUE NUMBER

ORIGINAL

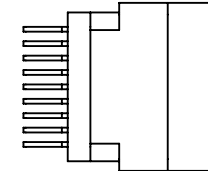
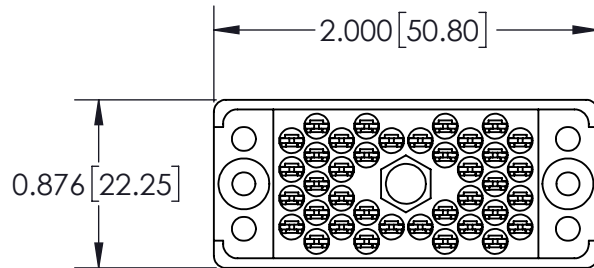

Features

- UL Recognized
- .150 (3.81) Contact Spacing x .130 (3.30) or .150 (3.81) Row Spacing with Staggered Grid
- Plug and Receptacle in 20, 38, 56, 90 or 120 Contact Sizes
- Edacon Hermaphroditic Contact Mating Design
- Contact Termination Options Include: Crimp, P.C. Tail, Wire Hole and Wire Wrap
- Mating and Unmating Simplified with use of Actuating Screws
- Optional Covers with Side or Top Entry Cable Clamp in Plastic or Metal Material Available for All Connector Sizes
- Versatile Metal Cover Design Permits Assembly and Disassembly after Cabling is Complete plus Cable Entry Style Flexibility
- Actuating Screws, Locknuts, Polarizing Hardware, Covers and Contacts Suitable for either Plug or Receptacle
- Polarizing Hardware Adjustable for 288 Mating Combinations
- Tools Available for Contact Installation, Removal and Crimping and Polarizing Changes

Specifications

- Insulator Material: Diallyl Phthalate or Thermo plastic Polyester, UL94V-0, Colour: Green, or Polycarbonate, Colour: Grey
- Contact Material: Phosphor Bronze Alloy CA-510
- Contact Plating: Gold over Nickel for Entire Contact
- Cover Material: Polycarbonate, Colour: Green, or Die-Cast Zinc, Finished with Grey Enamel Paint
- Current Rating: 8.5 Amperes
- Contact Resistance: 10 Milliohms Maximum
- Dielectric Withstanding Voltage: 2000 V AC rms at Sea Level
- Insulation Resistance: 5000 Megohms Minimum
- Operating Temperature: -65 to +125 Degrees C
- Insertion and Withdrawal Force: 2 to 16 oz (0.56 to 4.45 N) per Contact Position

See Accompanying Pages for:
 - PC Tail Layout
 - Cutout Panel Details
 - Cover Details

516 Assembly Part Number: 516-038-520-100		ACAD REFERENCE NO. 516 Assembly	
		DRAWN: J.LEE	DATE: JUNE 18, 2009
 EDAC INC TORONTO, ONTARIO CANADA YOUR CONNECTION TO QUALITY & SERVICE		CHECKED:	DATE:
		SCALE: 1:1	SHEET 1 OF 4
THESE DRAWINGS AND SPECIFICATIONS ARE THE PROPERTY OF EDAC INC. AND SHALL NOT BE REPRODUCED, OR COPIED OR USED AS THE BASIS FOR THE MANUFACTURE OR SALE OF APPARATUS WITHOUT WRITTEN PERMISSION.		DRAWING NUMBER	ISSUE
		516 Assembly	1

THIS IS A C.A.D. GENERATED DRAWING
DO NOT MAKE MANUAL REVISIONS TO MASTER.



ISSUE NUMBER

ORIGINAL

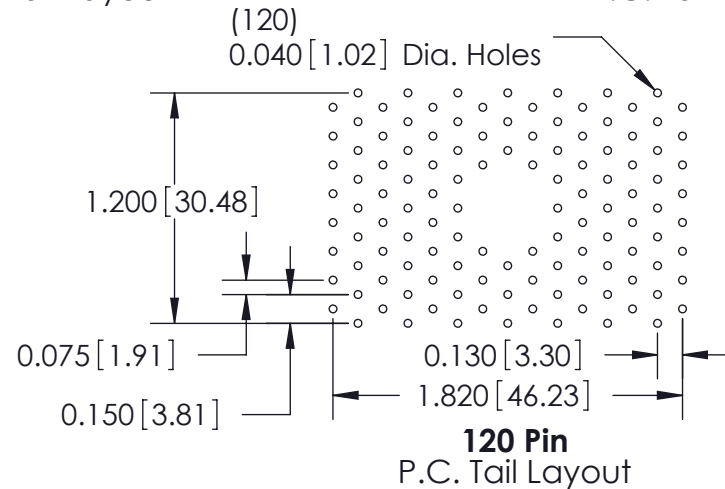
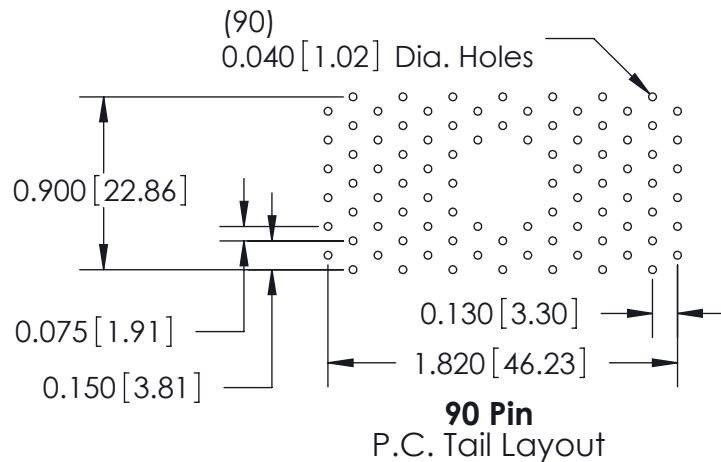
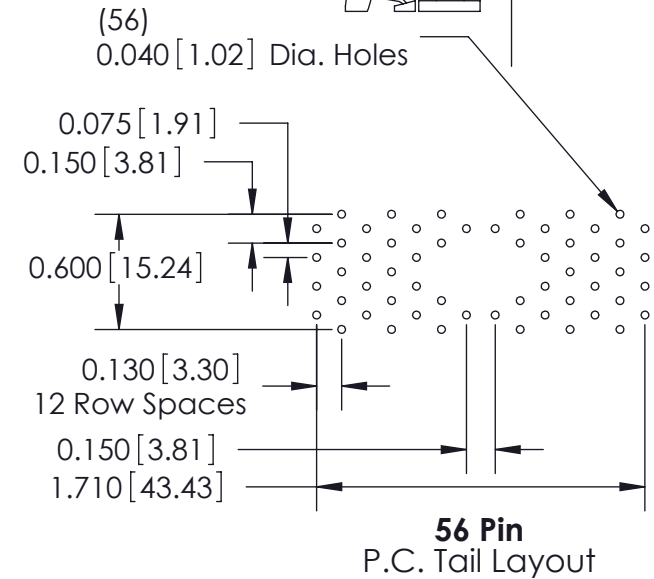
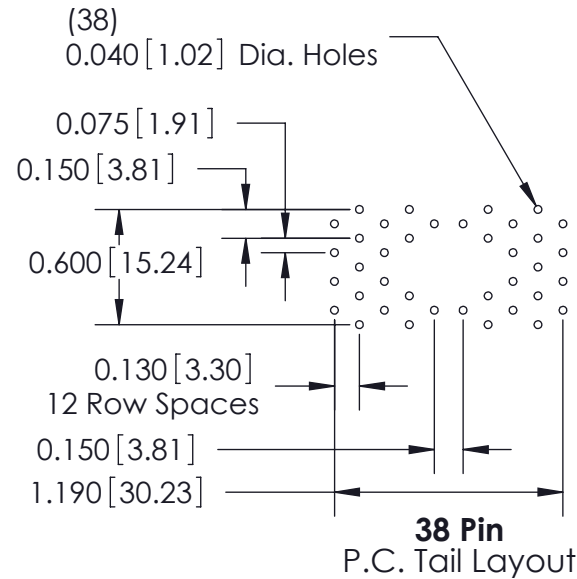
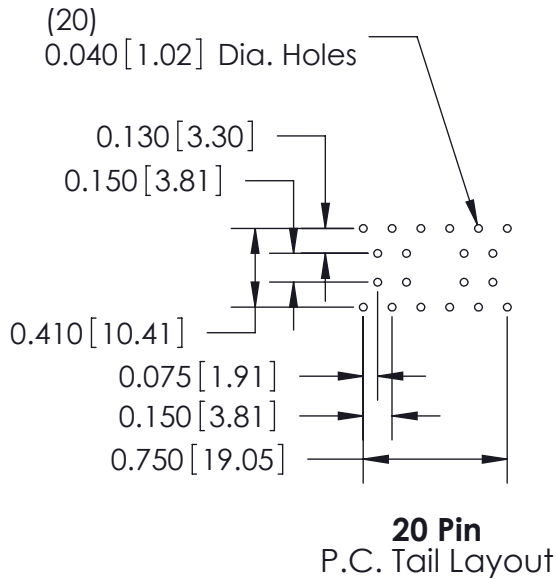

516 Assembly
P.C. Tail Layout Details



EDAC INC
TORONTO, ONTARIO
CANADA

YOUR CONNECTION TO QUALITY & SERVICE

THESE DRAWINGS AND SPECIFICATIONS
ARE THE PROPERTY OF EDAC INC. AND
SHALL NOT BE REPRODUCED, OR COPIED
OR USED AS THE BASIS FOR THE
MANUFACTURE OR SALE OF APPARATUS
WITHOUT WRITTEN PERMISSION.

ACAD REFERENCE NO. 516 Assembly

DRAWN: J.LEE DATE: JUNE 18, 2009

CHECKED: DATE:

SCALE: 1:1 SHEET 2 OF 4

DRAWING NUMBER

516 Assembly

ISSUE

1

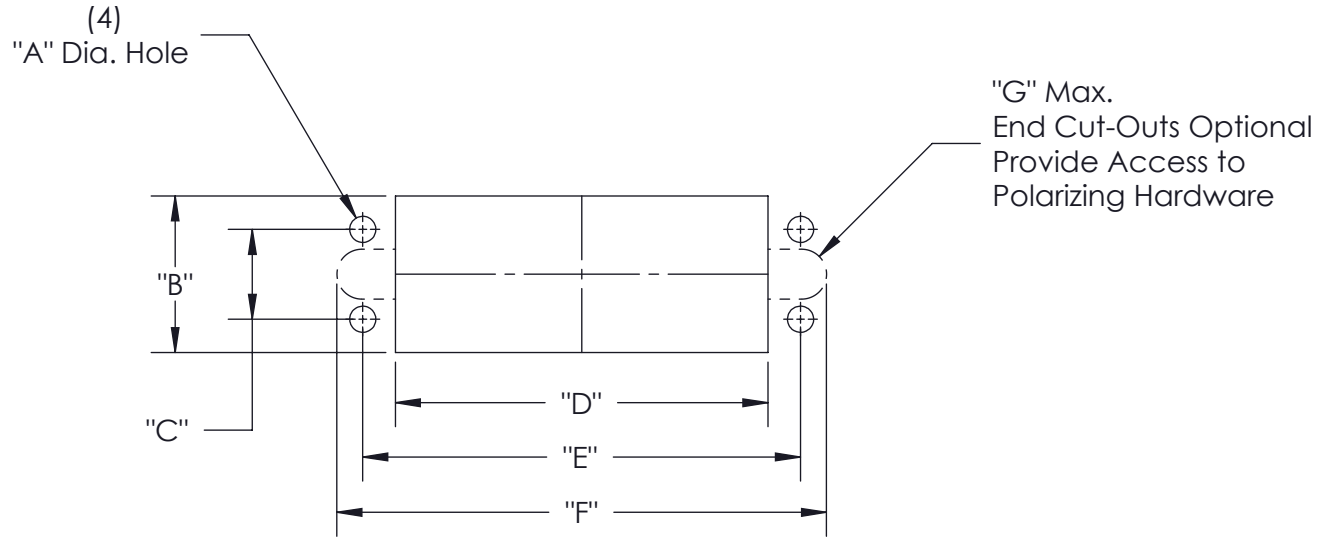

	Dimension A	Dimension B	Dimension C	Dimension D	Dimension E	Dimension F	Dimension G
20 Pin	0.104 [2.64]	0.640 [16.26]	0.410 [10.41]	0.960 [24.38]	1.126 [28.60]	1.270 [32.26]	R0.130 [R3.30]
38 Pin	0.136 [3.45]	0.816 [20.73]	0.468 [11.89]	1.420 [36.07]	1.688 [42.88]	1.958 [49.73]	R0.130 [R3.30]
56 Pin	0.136 [3.45]	0.816 [20.73]	0.468 [11.89]	1.940 [49.28]	2.280 [57.91]	2.550 [64.77]	R0.130 [R3.30]
90 Pin	0.136 [3.45]	1.120 [28.45]	0.765 [19.43]	2.050 [52.07]	2.282 [57.96]	2.675 [67.95]	R0.130 [R3.30]
120 Pin	0.136 [3.45]	1.420 [36.07]	0.875 [22.23]	2.050 [52.07]	2.375 [60.33]	2.675 [67.95]	R0.130 [R3.30]

516 Assembly Cut-Out Panel Detail		ACAD REFERENCE NO. 516 Assembly	
		DRAWN: J.LEE	DATE: JUNE 18, 2009
 EDAC INC TORONTO, ONTARIO CANADA YOUR CONNECTION TO QUALITY & SERVICE		CHECKED:	DATE:
		SCALE:	SHEET 3 OF 4
		DRAWING NUMBER 516 Assembly	ISSUE 1

THESE DRAWINGS AND SPECIFICATIONS ARE THE PROPERTY OF EDAC INC. AND SHALL NOT BE REPRODUCED, OR COPIED OR USED AS THE BASIS FOR THE MANUFACTURE OR SALE OF APPARATUS WITHOUT WRITTEN PERMISSION.

THIS IS A C.A.D. GENERATED DRAWING
DO NOT MAKE MANUAL REVISIONS TO MASTER.



ISSUE NUMBER

ORIGINAL

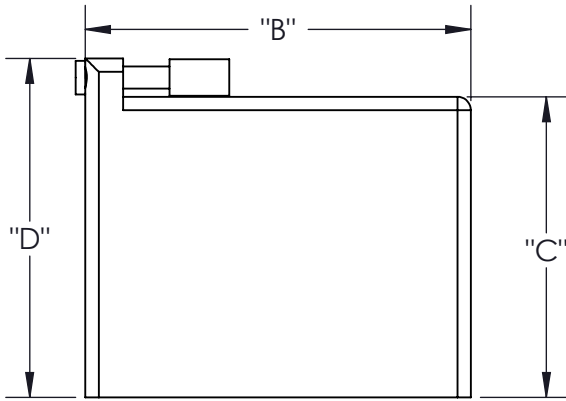

Top Entry

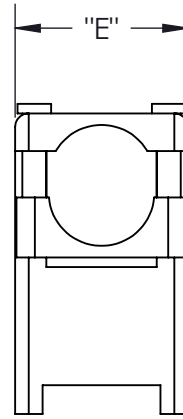

Side Entry

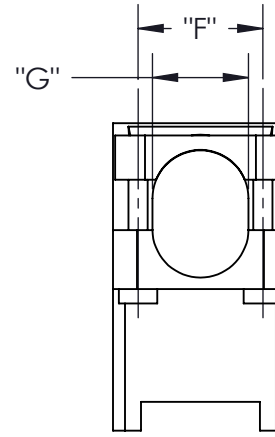

Standard Clamp

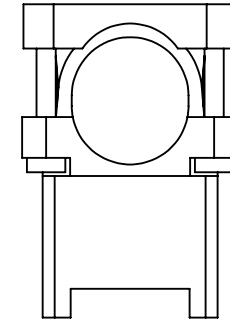

Large Clamp

Cover for Connector	Cover Material	Clamp Size	"A"	"B"	"C"	"D"	"E"	"F"	"G"
20 Pin	Plastic	Standard	1.605 (40.77)	1.325 (33.66)	0.906 (23.01)	1.190 (30.23)	0.715 (18.16)	0.450 (11.43)	0.450 (11.43)
20 Pin	Metal	Standard	1.539 (39.09)	1.325 (33.66)	0.906 (23.01)	1.120 (28.45)	0.686 (17.42)	0.446 (11.33)	0.490 (12.45)
38 Pin	Plastic	Standard	2.460 (62.48)	2.010 (51.05)	1.530 (38.86)	1.985 (50.42)	0.910 (23.11)	0.650 (16.51)	0.500 (12.70)
38 Pin	Plastic	Large	2.460 (62.48)	2.010 (51.05)	1.530 (38.86)	1.985 (50.42)	1.110 (28.19)	0.650 (16.51)	0.608 (15.44)
38 Pin	Metal	Standard	2.206 (56.03)	2.006 (50.95)	1.566 (39.78)	1.766 (44.86)	0.875 (22.23)	0.720 (18.29)	0.575 (14.61)
56 Pin	Plastic	Standard	2.602 (66.09)	2.602 (66.09)	1.530 (38.86)	1.985 (50.42)	0.910 (23.11)	0.650 (16.51)	0.500 (12.70)
56 Pin	Plastic	Large	2.602 (66.09)	2.602 (66.09)	1.530 (38.86)	1.985 (50.42)	1.110 (28.19)	0.650 (16.51)	0.608 (15.44)
56 Pin	Metal	Standard	2.602 (66.09)	2.602 (66.09)	1.566 (39.78)	1.766 (44.86)	0.875 (22.23)	0.720 (18.29)	0.575 (14.61)
90 Pin	Plastic	Standard	2.718 (69.04)	2.718 (69.04)	1.775 (45.09)	2.181 (55.40)	1.250 (31.75)	0.800 (20.32)	0.800 (20.32)
90 Pin	Metal	Standard	2.718 (69.04)	2.718 (69.04)	1.775 (45.09)	2.175 (55.25)	1.234 (31.34)	0.880 (22.35)	0.900 (22.86)
120 Pin	Plastic	Standard	2.750 (69.85)	2.750 (69.85)	2.020 (51.31)	2.426 (61.62)	1.530 (38.86)	0.800 (20.32)	1.080 (27.43)
120 Pin	Metal	Standard	2.750 (69.85)	2.750 (69.85)	2.020 (51.31)	2.445 (62.10)	1.531 (38.89)	0.890 (22.61)	1.080 (27.43)

516 Assembly
Cut-Out Panel Detail



EDAC INC
TORONTO, ONTARIO
CANADA
YOUR CONNECTION TO QUALITY & SERVICE

THESE DRAWINGS AND SPECIFICATIONS ARE THE PROPERTY OF EDAC INC. AND SHALL NOT BE REPRODUCED, OR COPIED OR USED AS THE BASIS FOR THE MANUFACTURE OR SALE OF APPARATUS WITHOUT WRITTEN PERMISSION.

ACAD REFERENCE NO. 516 Assembly

DRAWN: J.LEE DATE: JUNE 18, 2009

CHECKED: DATE:

SCALE: SHEET 4 OF 4

DRAWING NUMBER ISSUE

516 Assembly

1

Компания «Life Electronics» занимается поставками электронных компонентов импортного и отечественного производства от производителей и со складов крупных дистрибьюторов Европы, Америки и Азии.

С конца 2013 года компания активно расширяет линейку поставок компонентов по направлению коаксиальный кабель, кварцевые генераторы и конденсаторы (керамические, пленочные, электролитические), за счёт заключения дистрибьюторских договоров

Мы предлагаем:

- Конкуренеспособные цены и скидки постоянным клиентам.
- Специальные условия для постоянных клиентов.
- Подбор аналогов.
- Поставку компонентов в любых объемах, удовлетворяющих вашим потребностям.
- Приемлемые сроки поставки, возможна ускоренная поставка.
- Доставку товара в любую точку России и стран СНГ.
- Комплексную поставку.
- Работу по проектам и поставку образцов.
- Формирование склада под заказчика.
- Сертификаты соответствия на поставляемую продукцию (по желанию клиента).
- Тестирование поставляемой продукции.
- Поставку компонентов, требующих военную и космическую приемку.
- Входной контроль качества.
- Наличие сертификата ISO.

В составе нашей компании организован Конструкторский отдел, призванный помогать разработчикам, и инженерам.

Конструкторский отдел помогает осуществить:

- Регистрацию проекта у производителя компонентов.
- Техническую поддержку проекта.
- Защиту от снятия компонента с производства.
- Оценку стоимости проекта по компонентам.
- Изготовление тестовой платы монтаж и пусконаладочные работы.



Тел: +7 (812) 336 43 04 (многоканальный)
Email: org@lifeelectronics.ru