

MAX2680/MAX2681/ MAX2682

400MHz to 2.5GHz, Low-Noise, SiGe Downconverter Mixers

General Description

The MAX2680/MAX2681/MAX2682 miniature, low-cost, low-noise downconverter mixers are designed for low-voltage operation and are ideal for use in portable communications equipment. Signals at the RF input port are mixed with signals at the local oscillator (LO) port using a double-balanced mixer. These downconverter mixers operate with RF input frequencies between 400MHz and 2500MHz, and downconvert to IF output frequencies between 10MHz and 500MHz.

The MAX2680/MAX2681/MAX2682 operate from a single +2.7V to +5.5V supply, allowing them to be powered directly from a 3-cell NiCd or a 1-cell Lithium battery. These devices offer a wide range of supply currents and input intercept (IIP3) levels to optimize system performance. Additionally, each device features a low-power shutdown mode in which it typically draws less than 0.1µA of supply current. Consult the *Selector Guide* for various combinations of IIP3 and supply current.

The MAX2680/MAX2681/MAX2682 are manufactured on a high-frequency, low-noise, advanced silicon-germanium process and are offered in the space-saving 6-pin SOT23 package.

Applications

- 400MHz/900MHz/2.4GHz ISM-Band Radios
- Personal Communications Systems (PCS)
- Cellular and Cordless Phones
- Wireless Local Loop
- IEEE-802.11 and Wireless Data

Features

- 400MHz to 2.5GHz Operation
- +2.7V to +5.5V Single-Supply Operation
- Low Noise Figure: 6.3dB at 900MHz (MAX2680)
- High Input Third-Order Intercept Point (IIP3 at 2450MHz)
 - -6.9dBm at 5.0mA (MAX2680)
 - +1.0dBm at 8.7mA (MAX2681)
 - +3.2dBm at 15.0mA (MAX2682)
- < 0.1µA Low-Power Shutdown Mode
- Ultra-Small Surface-Mount Packaging

Ordering Information

PART	TEMP RANGE	PIN-PACKAGE	SOT TOP MARK
MAX2680EUT-T	-40°C to +85°C	6 SOT23	AAAR
MAX2681EUT-T	-40°C to +85°C	6 SOT23	AAAS
MAX2682EUT-T	-40°C to +85°C	6 SOT23	AAAT

Selector Guide

PART	I _{CC} (mA)	FREQUENCY								
		900MHz			1950MHz			2450MHz		
		IIP3 (dBm)	NF (dB)	GAIN (dB)	IIP3 (dBm)	NF (dB)	GAIN (dB)	IIP3 (dBm)	NF (dB)	GAIN (dB)
MAX2680	5.0	-12.9	6.3	11.6	-8.2	8.3	7.6	-6.9	11.7	7.0
MAX2681	8.7	-6.1	7.0	14.2	+0.5	11.1	8.4	+1.0	12.7	7.7
MAX2682	15.0	-1.8	6.5	14.7	+4.4	10.2	10.4	+3.2	13.4	7.9

Typical Operating Circuit appears at end of data sheet.

MAX2680/MAX2681/ MAX2682

400MHz to 2.5GHz, Low-Noise, SiGe Downconverter Mixers

Absolute Maximum Ratings

V _{CC} to GND	-0.3V to +6.0V
RFIN Input Power (50Ω source).....	+10dBm
LO Input Power (50Ω source)	+10dBm
SHDN, IFOUT, RFIN to GND	-0.3V to (V _{CC} + 0.3V)
LO to GND.....	(V _{CC} - 1V) to (V _{CC} + 0.3V)

Continuous Power Dissipation (T _A = +70°C)	
SOT23 (derate 8.7mW/°C above +70°C).....	696mW
Operating Temperature Range.....	-40°C to +85°C
Junction Temperature.....	+150°C
Storage Temperature Range.....	-65°C to +160°C
Lead Temperature (soldering, 10s)	+300°C

Stresses beyond those listed under "Absolute Maximum Ratings" may cause permanent damage to the device. These are stress ratings only, and functional operation of the device at these or any other conditions beyond those indicated in the operational sections of the specifications is not implied. Exposure to absolute maximum rating conditions for extended periods may affect device reliability.



CAUTION! ESD SENSITIVE DEVICE

DC Electrical Characteristics

(V_{CC} = +2.7V to +5.5V, SHDN = +2V, T_A = T_{MIN} to T_{MAX} unless otherwise noted. Typical values are at V_{CC} = +3V and T_A = +25°C. Minimum and maximum values are guaranteed over temperature by design and characterization.)

PARAMETER	SYMBOL	CONDITIONS	MIN	TYP	MAX	UNITS
Operating Supply Current	I _{CC}	MAX2680		5.0	7.7	mA
		MAX2681		8.7	12.7	
		MAX2682		15.0	21.8	
Shutdown Supply Current	I _{CC}	SHDN = 0.5V		0.05		μA
Shutdown Input Voltage High	V _{IH}		2.0			V
Shutdown Input Voltage Low	V _{IL}				0.5	V
Shutdown Input Bias Current	I _{SHDN}	0 < SHDN < V _{CC}		0.2		μA

AC Electrical Characteristics

(MAX2680/1/2 EV Kit, V_{CC} = SHDN = +3.0V, T_A = +25°C, unless otherwise noted. RFIN and IFOUT matched to 50Ω. P_{LO} = -5dBm, P_{RFIN} = -25dBm.)

PARAMETER	CONDITIONS	MIN	TYP	MAX	UNITS
MAX2680					
RF Frequency Range	(Notes 1, 2)	400		2500	MHz
LO Frequency Range	(Notes 1, 2)	400		2500	MHz
IF Frequency Range	(Notes 1, 2)	10		500	MHz
Conversion Power Gain	f _{RF} = 400MHz, f _{LO} = 445MHz, f _{IF} = 45MHz		7.3		dB
	f _{RF} = 900MHz, f _{LO} = 970MHz, f _{IF} = 70MHz		11.6		
	f _{RF} = 1950MHz, f _{LO} = 1880MHz, f _{IF} = 70MHz (Note 1)	5.7	7.6	8.6	
	f _{RF} = 2450MHz, f _{LO} = 2210MHz, f _{IF} = 240MHz		7.0		
Gain Variation Over Temperature	f _{RF} = 1950MHz, f _{LO} = 1880MHz, f _{IF} = 70MHz, T _A = T _{MIN} to T _{MAX} (Note 1)		1.9	2.4	dB
Input Third-Order Intercept Point (Note 3)	f _{RF} = 900MHz, 901MHz, f _{LO} = 970MHz, f _{IF} = 70MHz		-12.9		dBm
	f _{RF} = 1950MHz, 1951MHz, f _{LO} = 1880MHz, f _{IF} = 70MHz		-8.2		
	f _{RF} = 2450MHz, 2451MHz, f _{LO} = 2210MHz, f _{IF} = 240MHz		-6.9		
Noise Figure (Single Sideband)	f _{RF} = 900MHz, f _{LO} = 970MHz, f _{IF} = 70MHz		6.3		dB
	f _{RF} = 1950MHz, f _{LO} = 2020MHz, f _{IF} = 70MHz		8.3		
	f _{RF} = 2450MHz, f _{LO} = 2210MHz, f _{IF} = 240MHz		11.7		
LO Input VSWR	50Ω source impedance		1.5:1		
LO Leakage at IFOUT Port	f _{LO} = 1880MHz		-22		dBm

AC Electrical Characteristics (continued)

(MAX2680/1/2 EV Kit, $V_{CC} = \overline{SHDN} = +3.0V$, $T_A = +25^\circ C$, unless otherwise noted. RFIN and IFOUT matched to 50Ω. $P_{LO} = -5dBm$, $P_{RFIN} = -25dBm$.)

PARAMETER	CONDITIONS	MIN	TYP	MAX	UNITS
LO Leakage at RFIN Port	$f_{LO} = 1880MHz$		-26		dBm
IF/2 Spurious Response	$f_{RF} = 1915MHz$, $f_{LO} = 1880MHz$, $f_{IF} = 70MHz$ (Note 4)		-51		dBm
MAX2681					
RF Frequency Range	(Notes 1, 2)	400		2500	MHz
LO Frequency Range	(Notes 1, 2)	400		2500	MHz
IF Frequency Range	(Notes 1, 2)	10		500	MHz
Conversion Power Gain	$f_{RF} = 400MHz$, $f_{LO} = 445MHz$, $f_{IF} = 45MHz$		11.0		dB
	$f_{RF} = 900MHz$, $f_{LO} = 970MHz$, $f_{IF} = 70MHz$		14.2		
	$f_{RF} = 1950MHz$, $f_{LO} = 1880MHz$, $f_{IF} = 70MHz$ (Note 1)	6.7	8.4	9.4	
	$f_{RF} = 2450MHz$, $f_{LO} = 2210MHz$, $f_{IF} = 240MHz$		7.7		
Gain Variation Over Temperature	$f_{RF} = 1950MHz$, $f_{LO} = 1880MHz$, $f_{IF} = 70MHz$, $T_A = T_{MIN}$ to T_{MAX} (Note 1)		1.7	2.3	dB
Input Third-Order Intercept Point (Note 3)	$f_{RF} = 900MHz$, $901MHz$, $f_{LO} = 970MHz$, $f_{IF} = 70MHz$		-6.1		dBm
	$f_{RF} = 1950MHz$, $1951MHz$, $f_{LO} = 1880MHz$, $f_{IF} = 70MHz$		+0.5		
	$f_{RF} = 2450MHz$, $2451MHz$, $f_{LO} = 2210MHz$, $f_{IF} = 240MHz$		+1.0		
Noise Figure (Single Sideband)	$f_{RF} = 900MHz$, $f_{LO} = 970MHz$, $f_{IF} = 70MHz$		7.0		dB
	$f_{RF} = 1950MHz$, $f_{LO} = 2020MHz$, $f_{IF} = 70MHz$		11.1		
	$f_{RF} = 2450MHz$, $f_{LO} = 2210MHz$, $f_{IF} = 240MHz$		12.7		
LO Input VSWR	50Ω source impedance		1.5:1		
LO Leakage at IFOUT Port	$f_{LO} = 1880MHz$		-23		dBm
LO Leakage at RFIN Port	$f_{LO} = 1880MHz$		-27		dBm
IF/2 Spurious Response	$f_{RF} = 1915MHz$, $f_{LO} = 1880MHz$, $f_{IF} = 70MHz$ (Note 4)		-65		dBm
MAX2682					
RF Frequency Range	(Notes 1, 2)	400		2500	MHz
LO Frequency Range	(Notes 1, 2)	400		2500	MHz
IF Frequency Range	(Notes 1, 2)	10		500	MHz
Conversion Power Gain	$f_{RF} = 400MHz$, $f_{LO} = 445MHz$, $f_{IF} = 45MHz$		13.4		dB
	$f_{RF} = 900MHz$, $f_{LO} = 970MHz$, $f_{IF} = 70MHz$		14.7		
	$f_{RF} = 1950MHz$, $f_{LO} = 1880MHz$, $f_{IF} = 70MHz$ (Note 1)	8.7	10.4	11.7	
	$f_{RF} = 2450MHz$, $f_{LO} = 2210MHz$, $f_{IF} = 240MHz$		7.9		
Gain Variation Over Temperature	$f_{RF} = 1950MHz$, $f_{LO} = 1880MHz$, $f_{IF} = 70MHz$, $T_A = T_{MIN}$ to T_{MAX} (Note 1)		2.1	3.2	dB
Input Third-Order Intercept Point (Note 3)	$f_{RF} = 900MHz$, $901MHz$, $f_{LO} = 970MHz$, $f_{IF} = 70MHz$		-1.8		dBm
	$f_{RF} = 1950MHz$, $1951MHz$, $f_{LO} = 1880MHz$, $f_{IF} = 70MHz$		+4.4		
	$f_{RF} = 2450MHz$, $2451MHz$, $f_{LO} = 2210MHz$, $f_{IF} = 240MHz$		+3.2		
Noise Figure (Single Sideband)	$f_{RF} = 900MHz$, $f_{LO} = 970MHz$, $f_{IF} = 70MHz$		6.5		dB
	$f_{RF} = 1950MHz$, $f_{LO} = 2020MHz$, $f_{IF} = 70MHz$		10.2		
	$f_{RF} = 2450MHz$, $f_{LO} = 2210MHz$, $f_{IF} = 240MHz$		13.4		

AC Electrical Characteristics (continued)

(MAX2680/1/2 EV Kit, $V_{CC} = \overline{\text{SHDN}} = +3.0\text{V}$, $T_A = +25^\circ\text{C}$, unless otherwise noted. RFIN and IFOUT matched to 50Ω . $P_{LO} = -5\text{dBm}$, $P_{\text{RFIN}} = -25\text{dBm}$.)

PARAMETER	CONDITIONS	MIN	TYP	MAX	UNITS
LO Input VSWR	50Ω source impedance		1.5:1		
LO Leakage at IFOUT Port	$f_{LO} = 1880\text{MHz}$		-23		dBm
LO Leakage at RFIN Port	$f_{LO} = 1880\text{MHz}$		-27		dBm
IF/2 Spurious Response	$f_{\text{RF}} = 1915\text{MHz}$, $f_{LO} = 1880\text{MHz}$, $f_{\text{IF}} = 70\text{MHz}$ (Note 4)		-61		dBm

Note 1: Guaranteed by design and characterization.

Note 2: Operation outside of this specification is possible, but performance is not characterized and is not guaranteed.

Note 3: Two input tones at -25dBm per tone.

Note 4: This spurious response is caused by a higher-order mixing product (2×2). Specified RF frequency is applied and IF output power is observed at the desired IF frequency (70MHz).

Typical Operating Characteristics

(Typical Operating Circuit, $V_{CC} = \overline{\text{SHDN}} = +3.0\text{V}$, $P_{\text{RFIN}} = -25\text{dBm}$, $P_{LO} = -5\text{dBm}$, $T_A = +25^\circ\text{C}$, unless otherwise noted.)

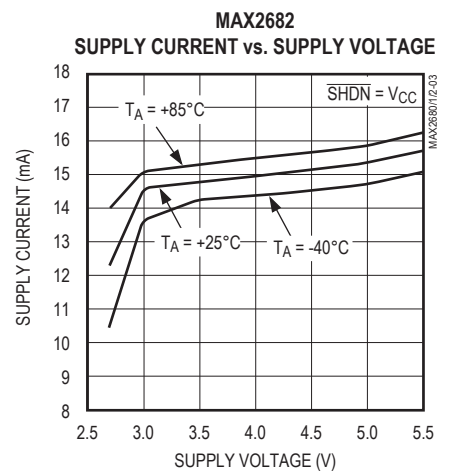
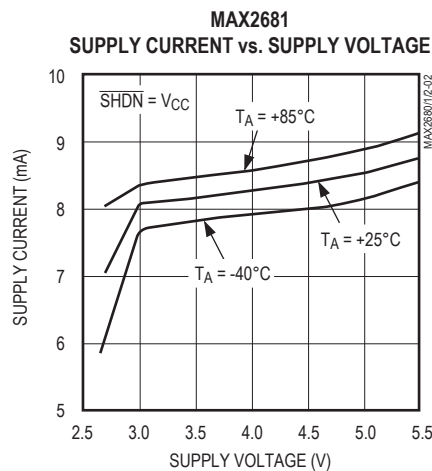
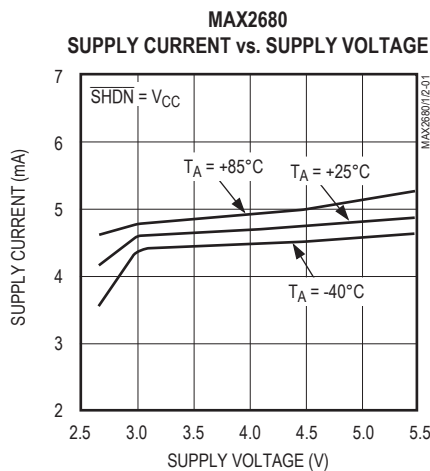

Typical Operating Characteristics (continued)

(Typical Operating Circuit, $V_{CC} = \overline{\text{SHDN}} = +3.0\text{V}$, $P_{\text{RFIN}} = -25\text{dBm}$, $P_{\text{LO}} = -5\text{dBm}$, $T_A = +25^\circ\text{C}$, unless otherwise noted.)

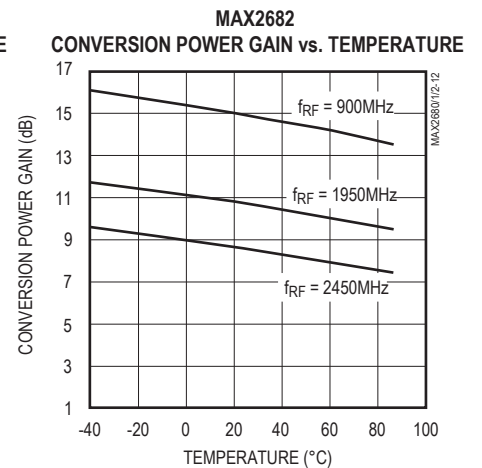
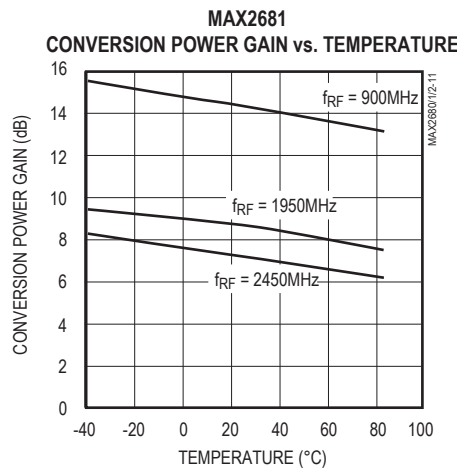
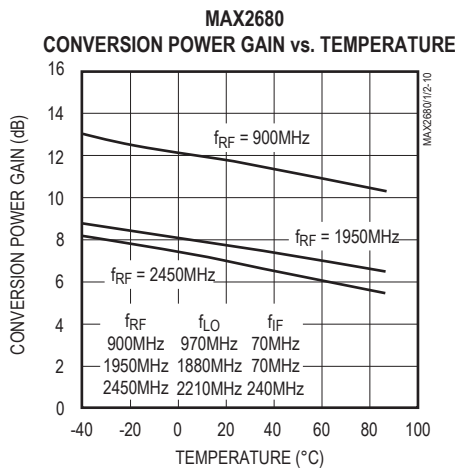
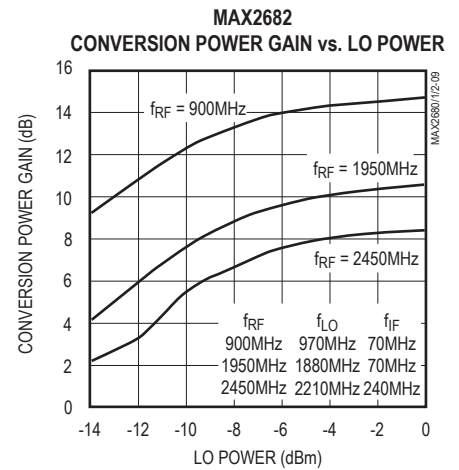
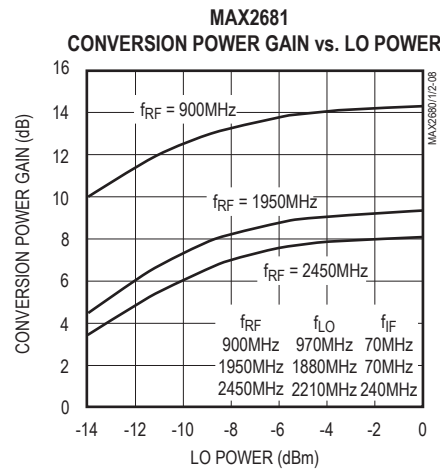
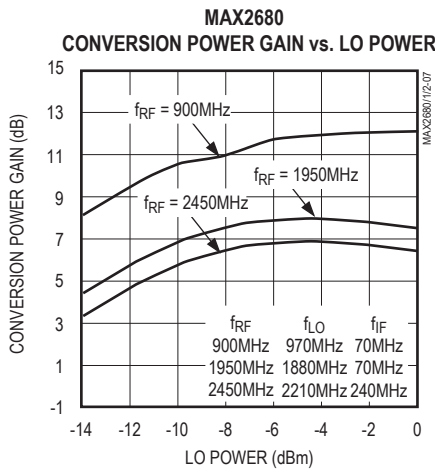
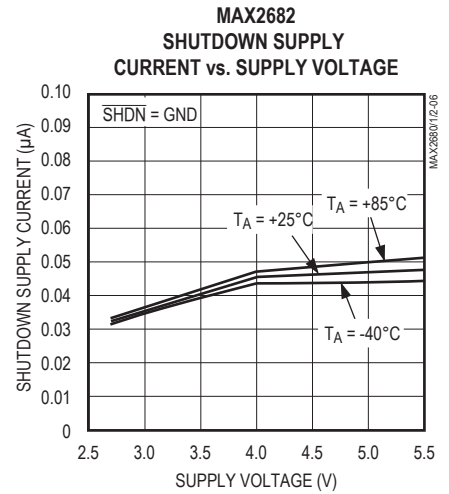
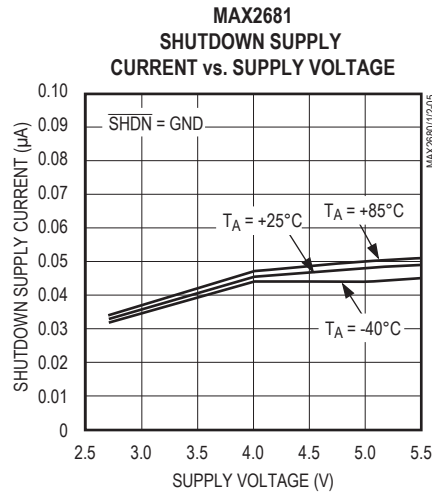
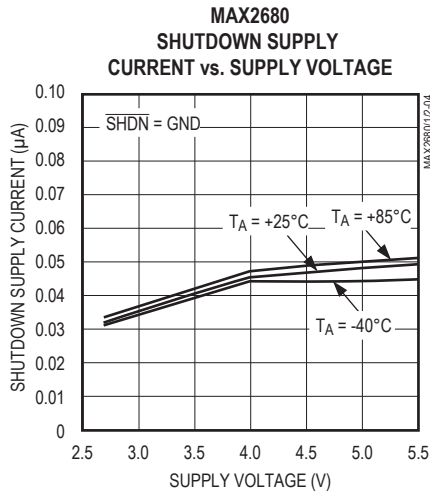

Typical Operating Characteristics (continued)

(Typical Operating Circuit, $V_{CC} = \overline{\text{SHDN}} = +3.0\text{V}$, $P_{\text{RFIN}} = -25\text{dBm}$, $P_{\text{LO}} = -5\text{dBm}$, $T_A = +25^\circ\text{C}$, unless otherwise noted.)

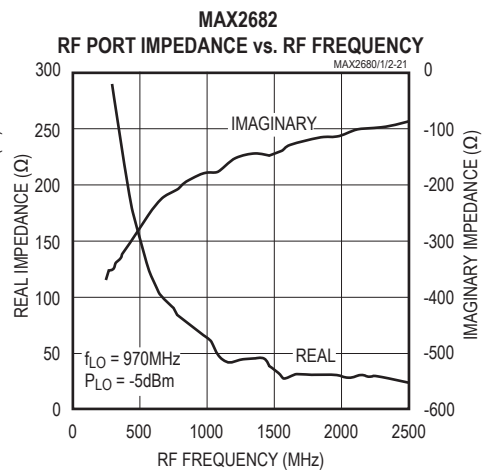
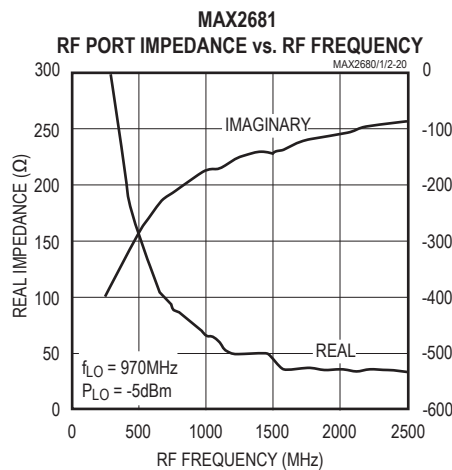
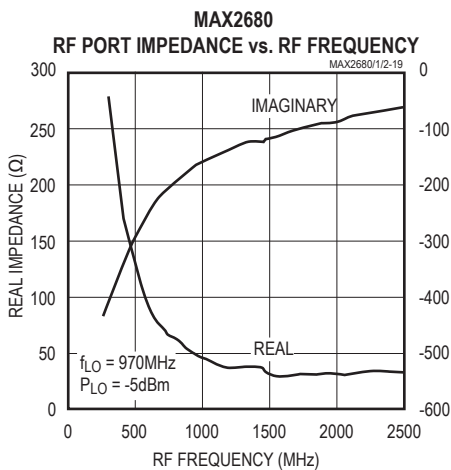
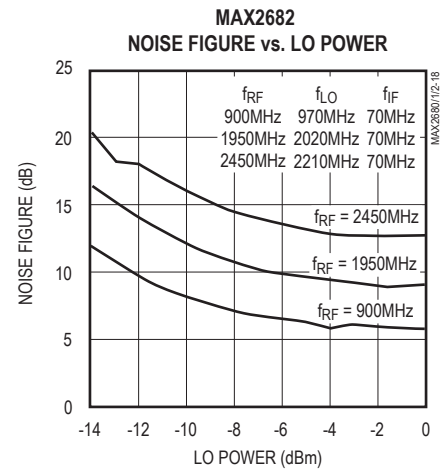
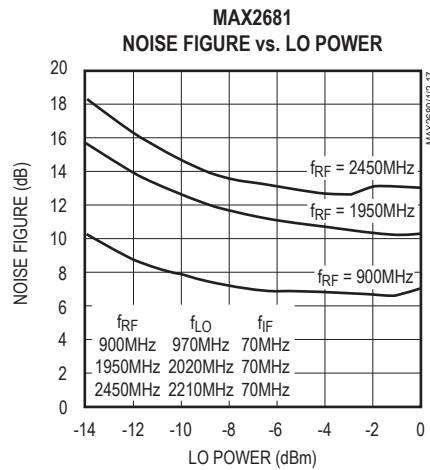
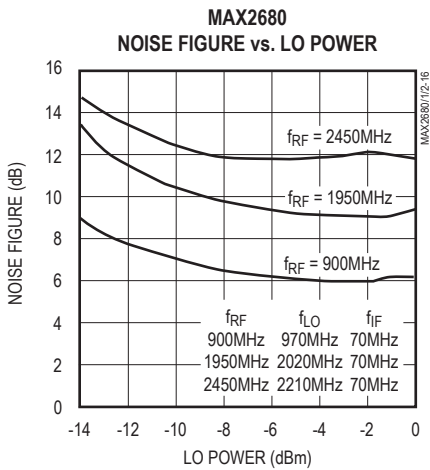
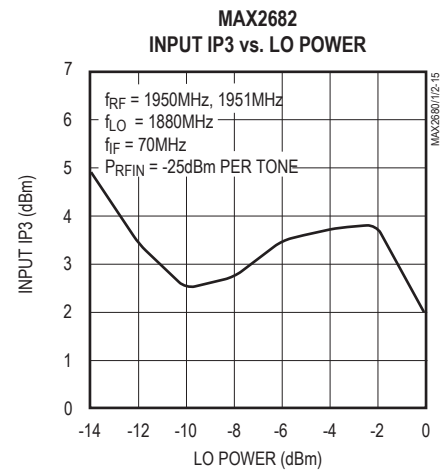
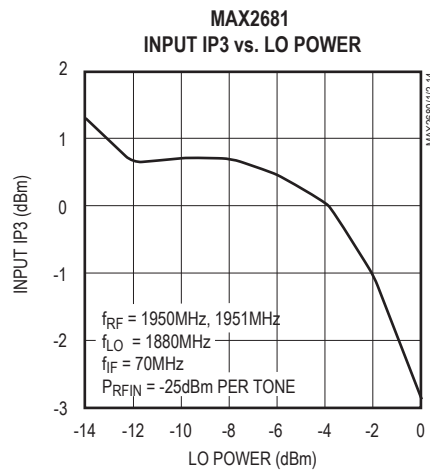
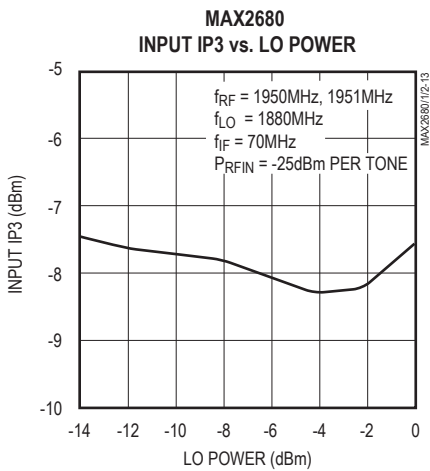

Typical Operating Characteristics (continued)

(Typical Operating Circuit, $V_{CC} = \overline{\text{SHDN}} = +3.0\text{V}$, $P_{\text{RFIN}} = -25\text{dBm}$, $P_{\text{LO}} = -5\text{dBm}$, $T_A = +25^\circ\text{C}$, unless otherwise noted.)

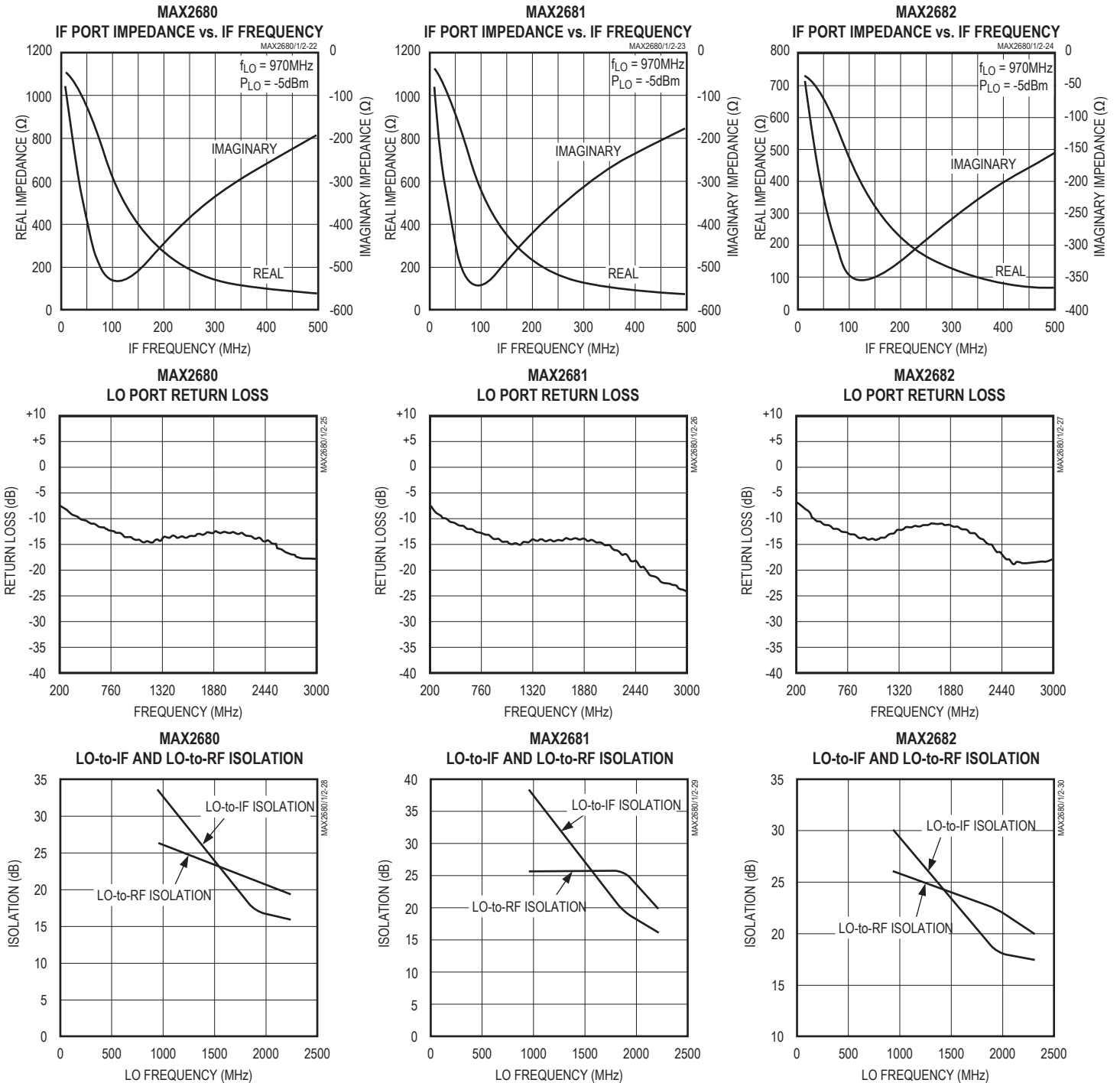

Typical Operating Characteristics (continued)

(Typical Operating Circuit, $V_{CC} = \overline{\text{SHDN}} = +3.0\text{V}$, $P_{\text{RFIN}} = -25\text{dBm}$, $P_{\text{LO}} = -5\text{dBm}$, $T_A = +25^\circ\text{C}$, unless otherwise noted.)

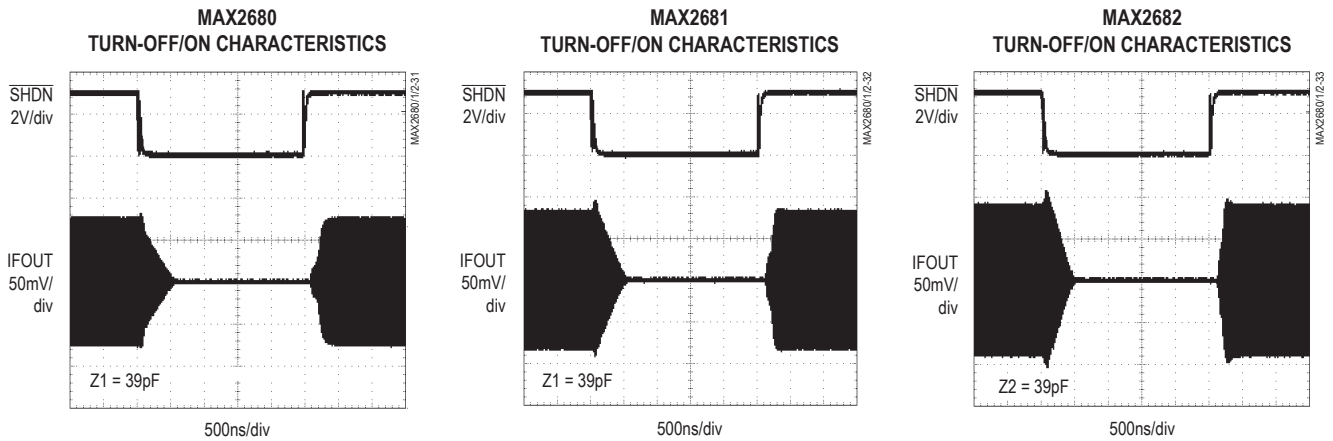

Pin Configuration

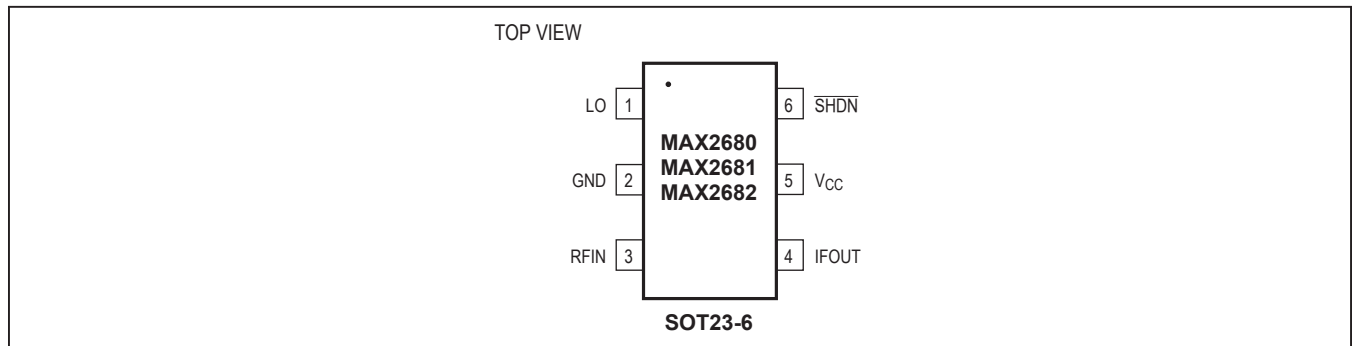

Pin Description

PIN	NAME	FUNCTION
1	LO	Local-Oscillator Input. Apply a local-oscillator signal with an amplitude of -10dBm to 0 (50Ω source). AC-couple this pin to the oscillator with a DC-blocking capacitor. Nominal DC voltage is $V_{CC} - 0.4\text{V}$.
2	GND	Mixer Ground. Connect to the ground plane with a low-inductance connection.
3	RFIN	Radio Frequency Input. AC-couple to this pin with a DC-blocking capacitor. Nominal DC voltage is 1.5V. See the <i>Applications Information</i> section for details on impedance matching.
4	IFOUT	Intermediate Frequency Output. Open-collector output requires an inductor to V_{CC} . AC-couple to this pin with a DC-blocking capacitor. See the <i>Applications Information</i> section for details on impedance matching.
5	V_{CC}	Supply Voltage Input, +2.7V to +5.5V. Bypass with a capacitor to the ground plane. Capacitor value depends upon desired operating frequency.
6	$\overline{\text{SHDN}}$	Active-Low Shutdown. Drive low to disable all device functions and reduce the supply current to less than 5μA. For normal operation, drive high or connect to V_{CC} .

Detailed Description

The MAX2680/MAX2681/MAX2682 are 400MHz to 2.5GHz, silicon-germanium, double-balanced downconverter mixers. They are designed to provide optimum linearity performance for a specified supply current. They consist of a double-balanced Gilbert-cell mixer with single-ended RF, LO, and IF port connections. An on-chip bias cell provides a low-power shutdown feature. Consult the [Selector Guide](#) for device features and comparison.

Applications Information

Local-Oscillator (LO) Input

The LO input is a single-ended broadband port with a typical input VSWR of better than 2.0:1 from 400MHz to 2.5GHz. The LO signal is mixed with the RF input signal, and the resulting downconverted output appears at IFOUT. AC-couple LO with a capacitor. Drive the LO port with a signal ranging from -10dBm to 0 (50Ω source).

RF Input

The RF input frequency range is 400MHz to 2.5GHz. The RF input requires an impedance-matching network as well as a DC-blocking capacitor that can be part of the matching network. Consult Tables 1 and 2, as well as the RF Port Impedance vs. RF Frequency graph in the [Typical Operating Characteristics](#) section for information on matching.

Table 1. RFIN Port Impedance

PART	FREQUENCY			
	400MHz	900MHz	1950MHz	2450MHz
MAX2680	179-j356	54-j179	32-j94	33-j73
MAX2681	209-j332	75-j188	34-j108	33-j86
MAX2682	206-j306	78-j182	34-j106	29-j86

Table 2. RF Input Impedance-Matching Component Values

MATCHING COMPONENTS	FREQUENCY											
	MAX2680				MAX2681				MAX2682			
	400 MHz	900 MHz	1950 MHz	2450 MHz	400 MHz	900 MHz	1950 MHz	2450 MHz	400 MHz	900 MHz	1950 MHz	2450 MHz
Z1	86nH	270pF	1.5pF	Short	68nH	270pF	1.5pF	Short	68nH	1.5pF	Short	Short
Z2	270pF	22nH	270pF	270pF	270pF	18nH	270pF	270pF	270pF	270pF	270pF	270pF
Z3	Open	Open	1.8nH	1.8nH	0.5pF	Open	1.8nH	2.2nH	0.5pF	10nH	2.2nH	1.2nH

Note: Z1, Z2, and Z3 are found in the *Typical Operating Circuit*.

IF Output

The IF output frequency range extends from 10MHz to 500MHz. IFOUT is a high-impedance, open-collector output that requires an external inductor to V_{CC} for proper biasing. For optimum performance, the IF port requires an impedance-matching network. The configuration and values for the matching network is dependent upon the frequency and desired output impedance. For assistance in choosing components for optimal performance, see [Table 3](#) and [Table 4](#) as well as the IF Port Impedance vs. IF Frequency graph in the [Typical Operating Characteristics](#) section.

Power-Supply and SHDN Bypassing

Proper attention to voltage supply bypassing is essential for high-frequency RF circuit stability. Bypass V_{CC} with a 10μF capacitor in parallel with a 1000pF capacitor. Use separate vias to the ground plane for each of the bypass capacitors and minimize trace length to reduce inductance. Use separate vias to the ground plane for each ground pin. Use low-inductance ground connections.

Decouple SHDN with a 1000pF capacitor to ground to minimize noise on the internal bias cell. Use a series resistor (typically 100Ω) to reduce coupling of high-frequency signals into the SHDN pin.

Layout Issues

A well-designed PC board is an essential part of an RF circuit. For best performance, pay attention to power-supply issues as well as to the layout of the RFIN and IFOUT impedance-matching network.

Table 3. IFOUT Port Impedance

PART	FREQUENCY		
	45MHz	70MHz	240MHz
MAX2680	960-j372	803-j785	186-j397
MAX2681	934-j373	746-j526	161-j375
MAX2682	670-j216	578-j299	175-j296

Table 4. IF Output Impedance-Matching Components

MATCHING COMPONENT	FREQUENCY		
	45MHz	70MHz	240MHz
L1	390nH	330nH	82nH
C2	39pF	15pF	3pF
R1	250Ω	Open	Open

Power-Supply Layout

To minimize coupling between different sections of the IC, the ideal power-supply layout is a star configuration with a large decoupling capacitor at a central V_{CC} node. The V_{CC} traces branch out from this central node, each going to a separate V_{CC} node on the PC board. At the end of each trace is a bypass capacitor that has low ESR at the RF frequency of operation. This arrangement provides local decoupling at the V_{CC} pin. At high frequencies, any signal leaking out of one supply pin sees a relatively high impedance (formed by the V_{CC} trace inductance) to the central V_{CC} node, and an even higher impedance to any other supply pin, as well as a low impedance to ground through the bypass capacitor.

Impedance-Matching Network Layout

The RFIN and IFOUT impedance-matching networks are very sensitive to layout-related parasitics. To minimize parasitic inductance, keep all traces short and place components as close as possible to the chip. To minimize parasitic capacitance, use cutouts in the ground plane (and any other plane) below the matching network components. However, avoid cutouts that are larger than necessary since they act as aperture antennas.

Typical Operating Circuit

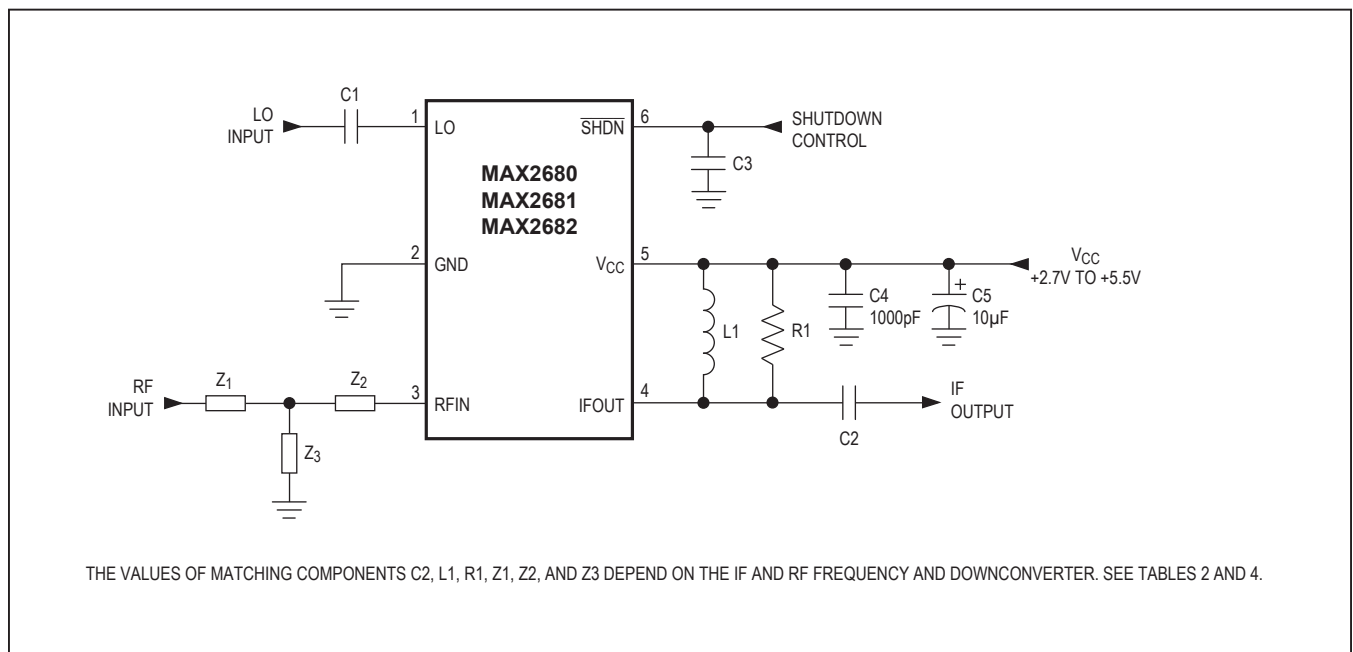

Package Information

For the latest package outline information and land patterns (footprints), go to www.maximintegrated.com/packages. Note that a "+", "#", or "-" in the package code indicates RoHS status only. Package drawings may show a different suffix character, but the drawing pertains to the package regardless of RoHS status.

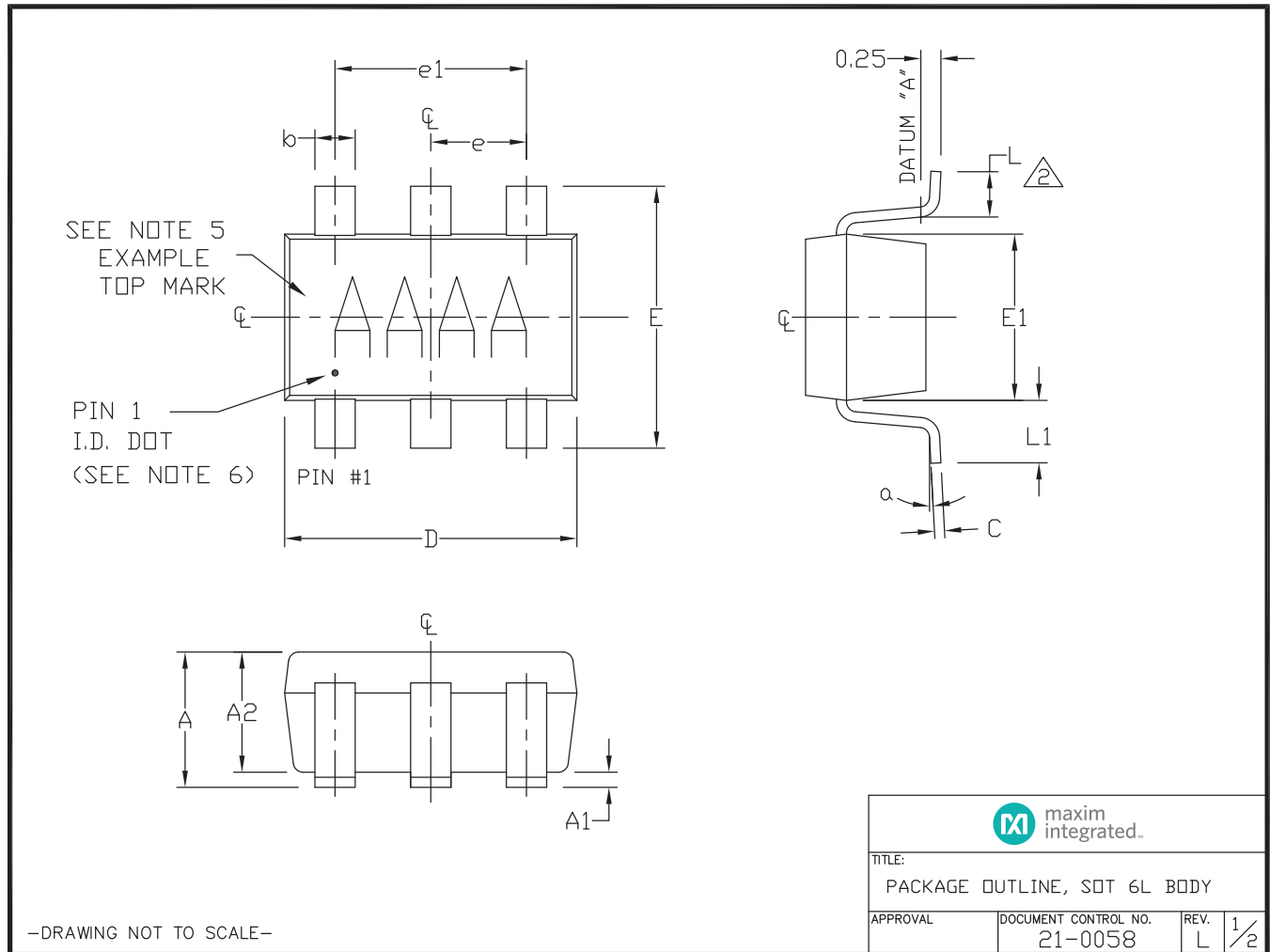

Package Information (continued)

For the latest package outline information and land patterns (footprints), go to www.maximintegrated.com/packages. Note that a "+", "#", or "-" in the package code indicates RoHS status only. Package drawings may show a different suffix character, but the drawing pertains to the package regardless of RoHS status.

NOTES:

1. ALL DIMENSIONS ARE IN MILLIMETERS.
2.  FOOT LENGTH MEASURED AT INTERCEPT POINT BETWEEN DATUM A & LEAD SURFACE.
3. PACKAGE OUTLINE EXCLUSIVE OF MOLD FLASH & METAL BURR. MOLD FLASH, PROTRUSION OR METAL BURR SHOULD NOT EXCEED 0.25mm.
4. PACKAGE OUTLINE INCLUSIVE OF SOLDER PLATING.
5. PIN 1 IS LOWER LEFT PIN WHEN READING TOP MARK FROM LEFT TO RIGHT. (SEE EXAMPLE TOP MARK)
6. PIN 1 I.D. DOT IS 0.3mm Ø MIN. LOCATED ABOVE PIN 1.
7. MEETS JEDEC MO178, VARIATION AB.
8. SOLDER THICKNESS MEASURED AT FLAT SECTION OF LEAD BETWEEN 0.08mm AND 0.15mm FROM LEAD TIP.
9. LEAD TO BE COPLANAR WITHIN 0.1mm.
10. NUMBER OF LEADS SHOWN ARE FOR REFERENCE ONLY.
11. MARKING IS FOR PACKAGE ORIENTATION REFERENCE ONLY.
12. ALL DIMENSIONS APPLY TO BOTH LEADED (-) AND PbFREE (+) PKG. CODES.

SYMBOL	MIN	NOMINAL	MAX
A	0.90	1.25	1.45
A1	0.00	0.05	0.15
A2	0.90	1.10	1.30
b	0.35	0.40	0.50
C	0.08	0.15	0.20
D	2.80	2.90	3.00
E	2.60	2.80	3.00
E1	1.50	1.625	1.75
L	0.35	0.45	0.60
L1	0.60 REF.		
e1	1.90 BSC.		
e	0.95 BSC.		
α	0°	2.5°	10°

PKG CODES:
U6-1, U6-2, U6-4, U6CN-2,
U6SN-1, U6F-6, U6FH-6; U6FH-7

** U6FH-7 TO BE USED FOR NP42 PARTS ONLY.

-DRAWING NOT TO SCALE-

 maxim integrated.			
TITLE: PACKAGE OUTLINE, SOT 6L BODY			
APPROVAL	DOCUMENT CONTROL NO. 21-0058	REV. L	2/2

For pricing, delivery, and ordering information, please contact Maxim Direct at 1-888-629-4642, or visit Maxim Integrated's website at www.maximintegrated.com.

Maxim Integrated cannot assume responsibility for use of any circuitry other than circuitry entirely embodied in a Maxim Integrated product. No circuit patent licenses are implied. Maxim Integrated reserves the right to change the circuitry and specifications without notice at any time. The parametric values (min and max limits) shown in the Electrical Characteristics table are guaranteed. Other parametric values quoted in this data sheet are provided for guidance.

Компания «Life Electronics» занимается поставками электронных компонентов импортного и отечественного производства от производителей и со складов крупных дистрибьюторов Европы, Америки и Азии.

С конца 2013 года компания активно расширяет линейку поставок компонентов по направлению коаксиальный кабель, кварцевые генераторы и конденсаторы (керамические, пленочные, электролитические), за счёт заключения дистрибьюторских договоров

Мы предлагаем:

- Конкурентоспособные цены и скидки постоянным клиентам.
- Специальные условия для постоянных клиентов.
- Подбор аналогов.
- Поставку компонентов в любых объемах, удовлетворяющих вашим потребностям.
- Приемлемые сроки поставки, возможна ускоренная поставка.
- Доставку товара в любую точку России и стран СНГ.
- Комплексную поставку.
- Работу по проектам и поставку образцов.
- Формирование склада под заказчика.
- Сертификаты соответствия на поставляемую продукцию (по желанию клиента).
- Тестирование поставляемой продукции.
- Поставку компонентов, требующих военную и космическую приемку.
- Входной контроль качества.
- Наличие сертификата ISO.

В составе нашей компании организован Конструкторский отдел, призванный помогать разработчикам, и инженерам.

Конструкторский отдел помогает осуществить:

- Регистрацию проекта у производителя компонентов.
- Техническую поддержку проекта.
- Защиту от снятия компонента с производства.
- Оценку стоимости проекта по компонентам.
- Изготовление тестовой платы монтаж и пусконаладочные работы.



Тел: +7 (812) 336 43 04 (многоканальный)

Email: org@lifeelectronics.ru