



**DP3T - SPDT Coaxial Switches DC to 6 GHz, DC to 20 GHz, DC to 26.5 GHz**

Radiall's PLATINUM SERIES switches are optimised to perform at a high level over an extended life span. With outstanding RF performances, and a guaranteed Insertion Loss repeatability of 0.03 dB over a life span of 10 million switching cycles. PLATINUM SERIES switches are perfect for automated test and measurement equipment, as well as signal monitoring devices.

**PART NUMBER SELECTION**

**R 595** . . . . .

**RF Connectors :**  
3 : SMA up to 6 GHz  
4 : SMA up to 20 GHz  
F : SMA up to 26.5 GHz

**Type :**  
3 : Latching  
4 : Latching + Indicators  
5 : Latching + Self Cut-Off  
6 : Latching + Self Cut-Off + Indicators

**Actuator Voltage :**  
3 : 24 Vdc  
7 : 15 Vdc

**Documentation :**  
- : Certificate Of Conformity  
C : Calibration certificate  
R : Calibration certificate + RF curves

**Actuator Terminal :**  
0 : Solder pins  
5 : D-Sub connector

**Options :**  
1 : Without option (Positive common)  
2 : Compatible TTL driver (high level)

**Switch model :**  
1 : Non terminated SPDT switch  
2 : Terminated SPDT switch  
3 : Terminated 4 port bypass switch  
4 : Non terminated 5 port DP3T switch

**PICTURE**

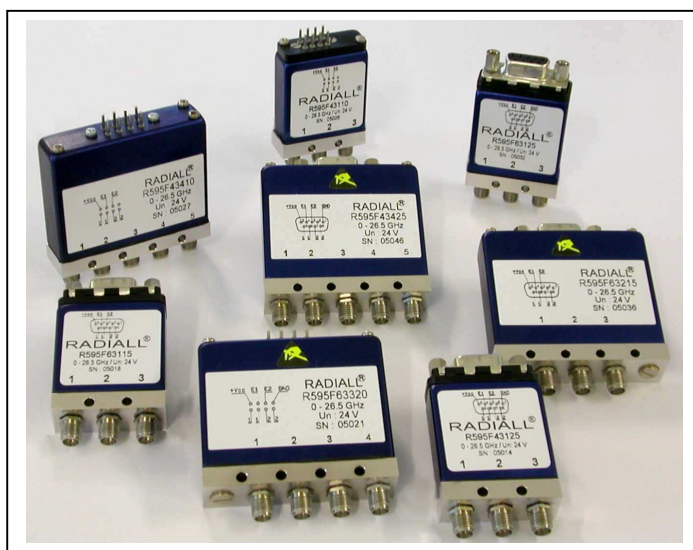

**RF PERFORMANCES**

PART NUMBER	R5953-----	R5954-----	R595F-----
Frequency Range GHz	DC to 6	DC to 20	DC to 26.5
Impedance Ohms	50		
Insertion Loss dB (Maximum)	0.20 + (0.45 / 26.5) x frequency (GHz)		
Isolation dB (Minimum)	85	DC to 6 GHz : 85 6 to 12.4 GHz : 75 12.4 to 20 GHz : 65	DC to 6 GHz : 85 6 to 12.4 GHz : 75 12.4 to 20 GHz : 65 20 to 26.5 GHz : 60
V.S.W.R. (Maximum)	1.15	DC to 6 GHz : 1.15 6 to 12.4 GHz : 1.25 12.4 to 18 GHz : 1.30 18 to 20 GHz : 1.60	DC to 6 GHz : 1.15 6 to 12.4 GHz : 1.25 12.4 to 18 GHz : 1.30 18 to 26.5 GHz : 1.60
Repeatability (Up to 10 million cycles measured at 25°C)	0.03 dB maximum	0.03 dB maximum	0.03 dB maximum

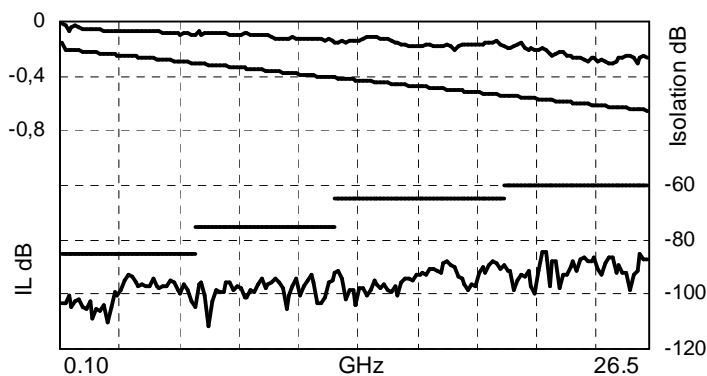
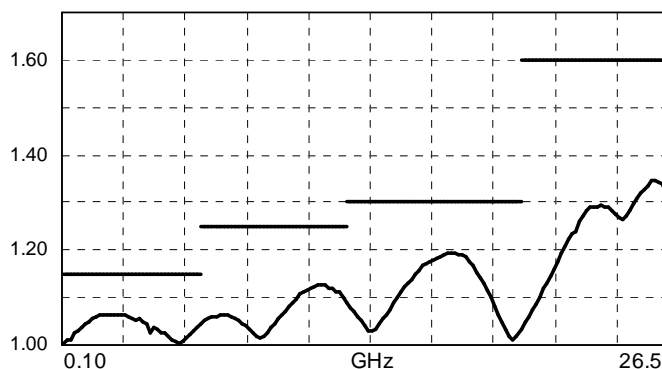
**TYPICAL RF PERFORMANCES****Insertion Loss and Isolation****V.S.W.R.**

**ADDITIONAL SPECIFICATIONS**

Operating mode		Latching	
Nominal operating voltage (across operating temperature) Vdc			24 (20 / 32)      15 (12 / 20)
Coil resistance (+/-10%)	Ohms	SPDT	350      120
		Terminated SPDT, DP3T, Bypass	175      60
Nominal operating current at 23°C	mA	SPDT	68      125
		Terminated SPDT, DP3T, Bypass	140      250
Average power		RF path    Cold switching : see Power Rating Chart on page 12 Hot switching : 1 Watt CW	
		Internal terminations    1 Watt average into 50 Ω	
TTL input	High Level	3 to 7 V	800 μA max at 7 V
	Low Level	0 to 0.8 V	20 μA max at 0.8V
Switching time (max)	ms	15	
Life (min)		10 million cycles	
Connectors		SMA	
Actuator terminals		D-Sub 9 pin female Solder pins	
Weight (max)	g	SPDT	< 60
		Terminated SPDT, DP3T, Bypass	< 100

**ENVIRONMENTAL SPECIFICATIONS**

Operating temperature range	°C	-25 to +75
Storage temperature range	°C	-55 to +85
Temperature cycling (MIL-STD-202F , Method 107D , Cond.A)	°C	-55 to +85 (10 cycles)
Sine vibration operating (MIL STD 202 , Method 204D , Cond.D)		10-2000 Hz, 20g
Random vibration operating		16.91g (rms) 50-2000 Hz 3min/axis
Shock operating (MIL STD 202 , Method 213B , Cond.G)		50g / 11 ms, sawtooth
Humidity operating		15 to 95% relative humidity
Humidity storage (MIL STD 202 , Method 106E , Cond.E)		65°C, 95% RH, 10 days
Altitude operating		15,000 feet (4,600 meters)
Altitude storage (MIL STD 202 , Method 105C , Cond.B)		50,000 feet (15,240 meters)





**HIGH PERFORMANCE DP3T - SPDT SWITCHES**

**SWITCH MODEL 1 : NON TERMINATED SPDT SWITCH**

The non terminated SPDT switch is a single pole double throw switch. This switch is "break before make".

**RF SCHEMATIC DIAGRAM**

**POSITION E1**

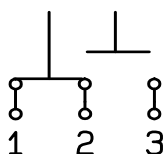

**POSITION E2**

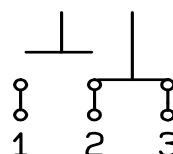

**POSITION INDICATORS**

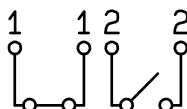

**STATE "11"**

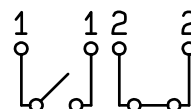

**STATE "22"**

**Standard drive option "1" (Positive common):**

- Connect pin +Vcc to supply.
- Select desired RF path by applying ground to the corresponding "close" pin (Ex: ground pin E1 to switch to position E1. RF path 1-2 closed and RF path 2-3 open).
- To open desired path and close the new RF path, connect ground to the corresponding "close" pin (Ex: ground pin E2 to open RF path 1-2 and close RF path 2-3).

**TTL drive option "2"**

- Connect pin GND to ground.
- Connect pin +Vcc to supply
- Select (close) desired RF path by applying TTL "High" to the corresponding "drive" pin (Ex: apply TTL "High" to pin E1 to switch to position E1. RF path 1-2 closed and RF path 2-3 open).
- To open desired path and close the new RF path, apply TTL "High" to the "drive" pin which corresponds to the desired RF path. (Ex: apply TTL "High" to pin E2 to open RF path 1-2 and close RF path 2-3).

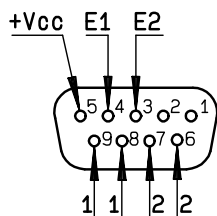

**D-Sub connector**

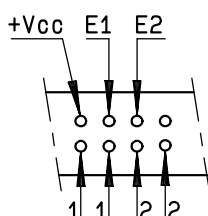

**Solder pins**

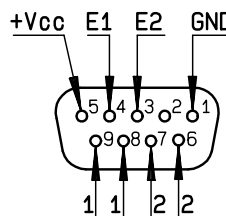

**D-Sub connector**

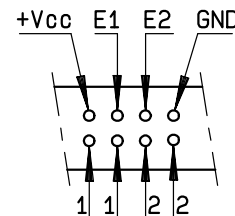

**Solder pins**



All dimensions are in inches/millimetres.

With D-Sub connector

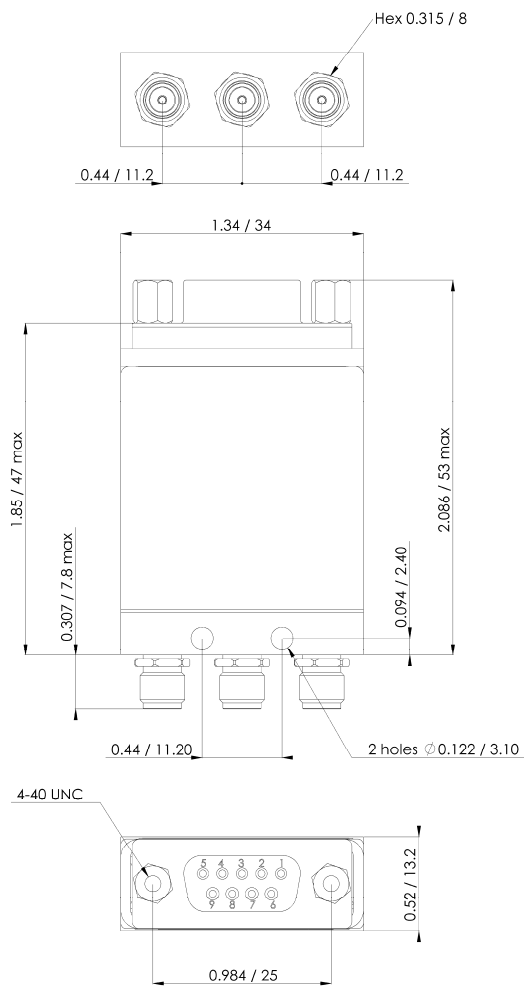

With solder pins

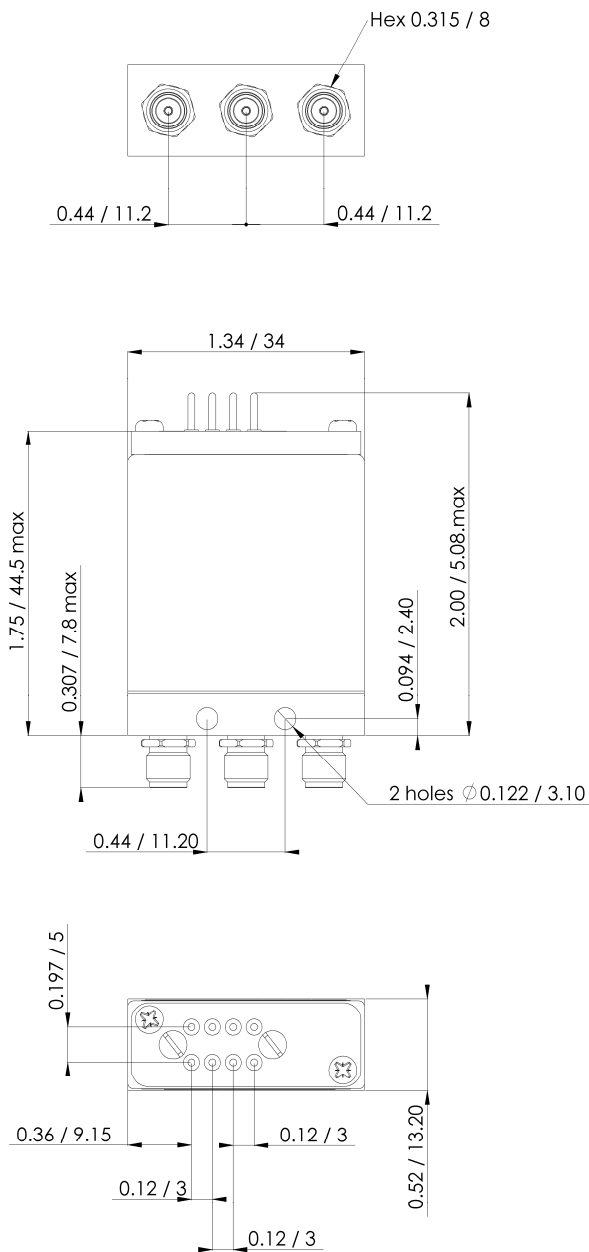



**SWITCH MODEL 2 : TERMINATED SPDT SWITCH**

The terminated SPDT switch is a single pole double throw switch. The unused ports are terminated into 50 ohms. This switch is "break before make".

**RF SCHEMATIC DIAGRAM**



**POSITION INDICATORS**

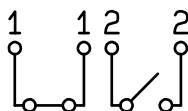

**STATE "11"**

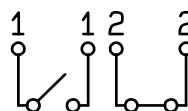

**STATE "22"**

**Standard drive option "1" (Positive common):**

- Connect pin +Vcc to supply.
- Select desired RF path by applying ground to the corresponding "close" pin (Ex: ground pin E1 to switch to position E1. RF path 1-2 closed and RF path 2-3 open).
- To open desired path and close the new RF path, connect ground to the corresponding "close" pin (Ex: ground pin E2 to open RF path 1-2 and close RF path 2-3).

**TTL drive option "2"**

- Connect pin GND to ground.
- Connect pin +Vcc to supply
- Select (close) desired RF path by applying TTL "High" to the corresponding "drive" pin (Ex: apply TTL "High" to pin E1 to switch to position E1. RF path 1-2 closed and RF path 2-3 open).
- To open desired path and close the new RF path, apply TTL "High" to the "drive" pin which corresponds to the desired RF path. (Ex: apply TTL "High" to pin E2 to open RF path 1-2 and close RF path 2-3).

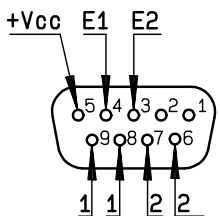

**D-Sub connector**

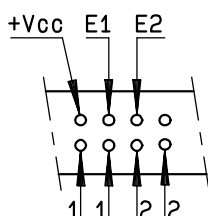

**Solder pins**

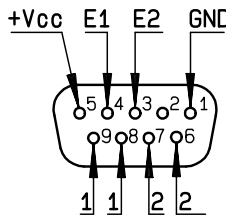

**D-Sub connector**

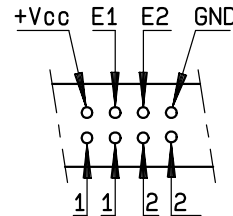

**Solder pins**





All dimensions are in inches/millimetres.

With D-Sub connector

With solder pins

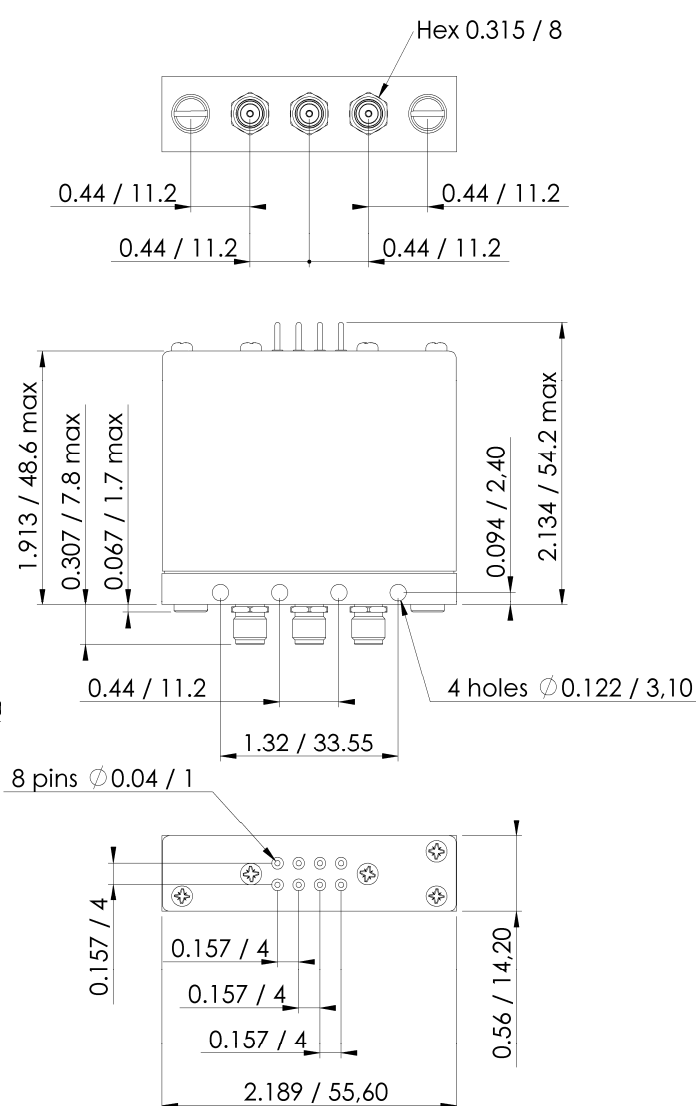
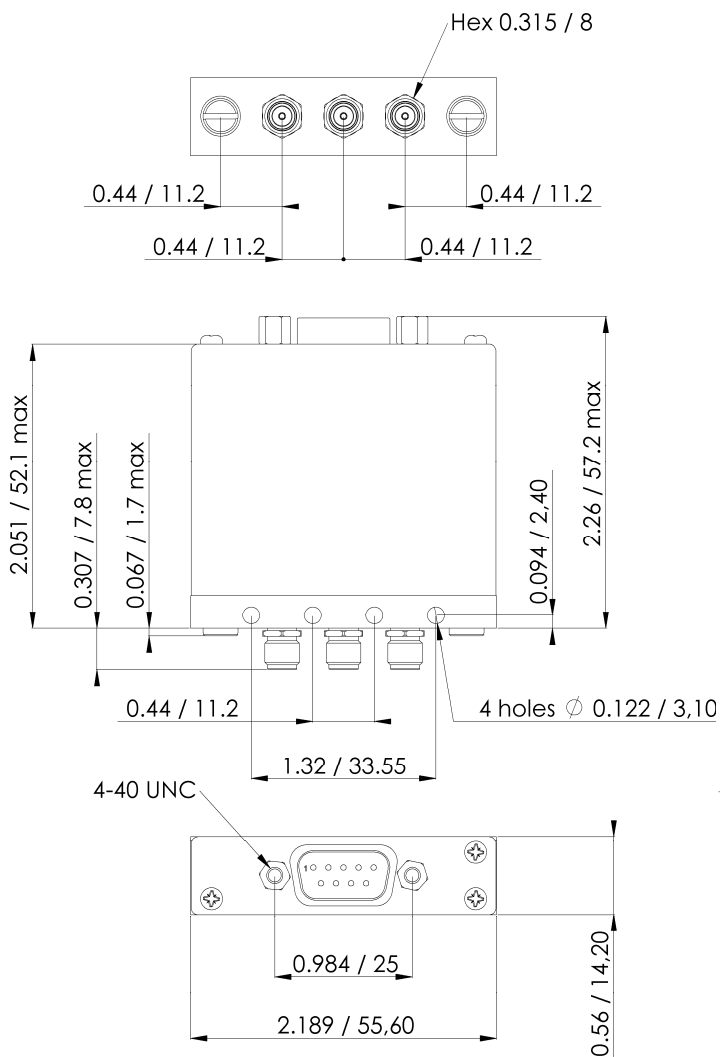



**HIGH PERFORMANCE DP3T - SPDT SWITCHES**

**SWITCH MODEL 3 : TERMINATED 4 PORT BYPASS SWITCH**

The terminated 4 port bypass switch can terminate into 50 ohms the device under test. These switches are "break before make".

**RF SCHEMATIC DIAGRAM**



**POSITION INDICATORS**

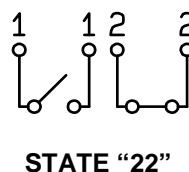
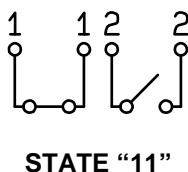

**Standard drive option "1" (Positive common):**

- Connect pin +Vcc to supply.
- Select desired RF path by applying ground to the corresponding "close" pin (Ex: ground pin E1 to switch to position E1. RF path 1-2 and RF path 3-4 closed and RF path 2-3 open).
- To open desired path and close the new RF path, connect ground to the corresponding "close" pin (Ex: ground pin E2 to open RF path 1-2 and 3-4 and close RF path 2-3).

**TTL drive option "2"**

- Connect pin GND to ground.
- Connect pin +Vcc to supply.
- Select (close) desired RF path by applying TTL "High" to the corresponding "drive" pin (Ex: apply TTL "High" to pin E1 to switch to position E1. RF path 1-2 and 3-4 closed and RF path 2-3 open).
- To open desired path and close the new RF path, apply TTL "High" to the "drive" pin which corresponds to the desired RF path. (Ex: apply TTL "High" to pin E2 to open RF path 1-2 and 3-4 and close RF path 2-3).

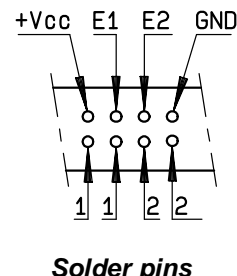
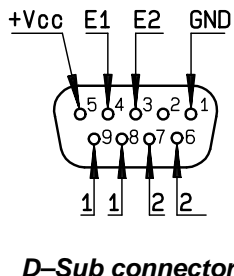
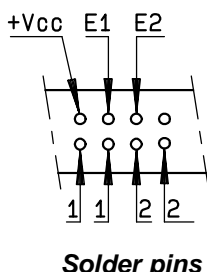
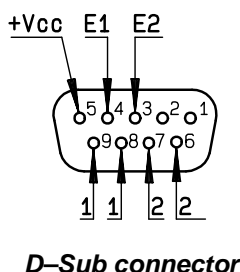





All dimensions are in inches/millimetres.

With D-Sub connector

With solder pins

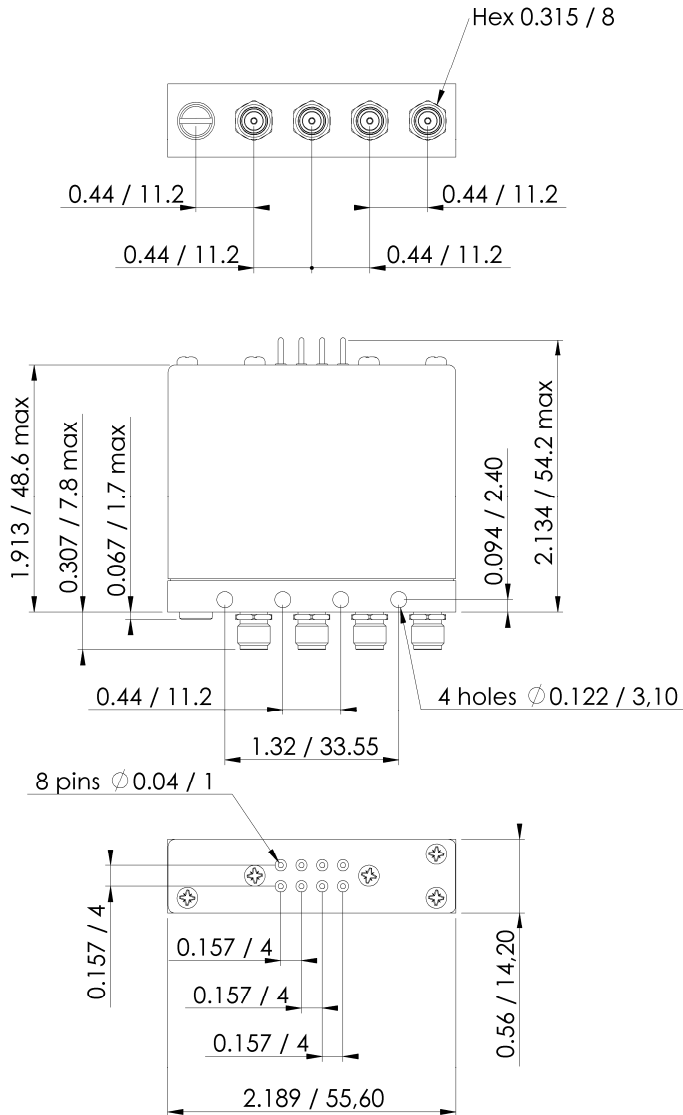
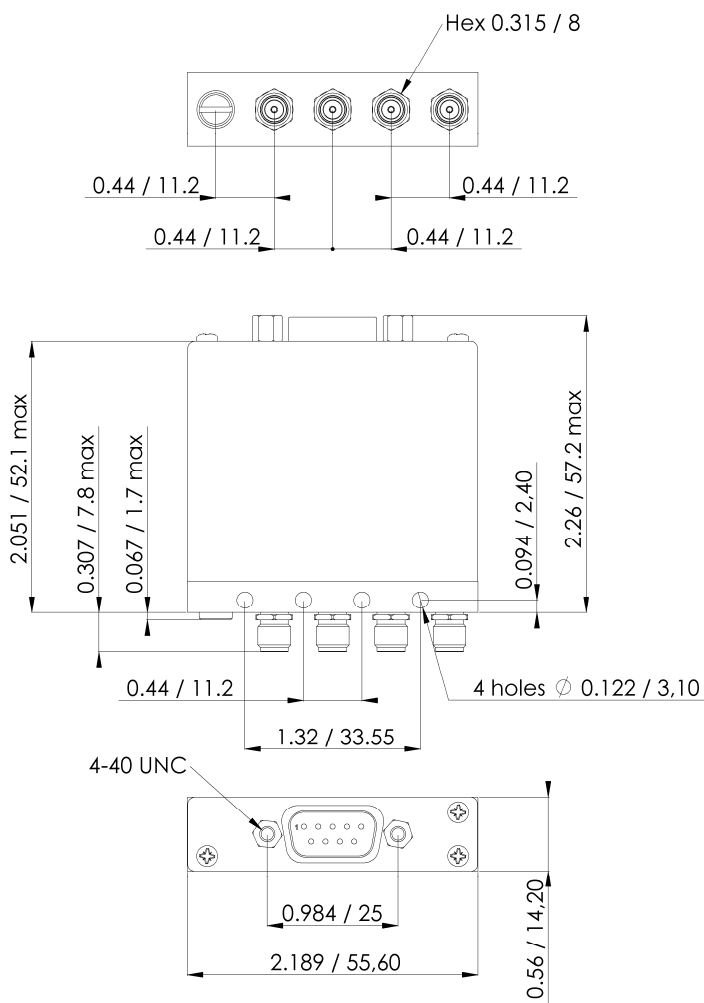



**SWITCH MODEL 4 : NON TERMINATED 5 PORT DP3T SWITCH**

The non terminated 5 port DP3T switch can used as SPDT with high power terminations, as a bypass switch. In this application, the fifth port can be terminated externally with a high power termination. These switches are "break before make".

**RF SCHEMATIC DIAGRAM**

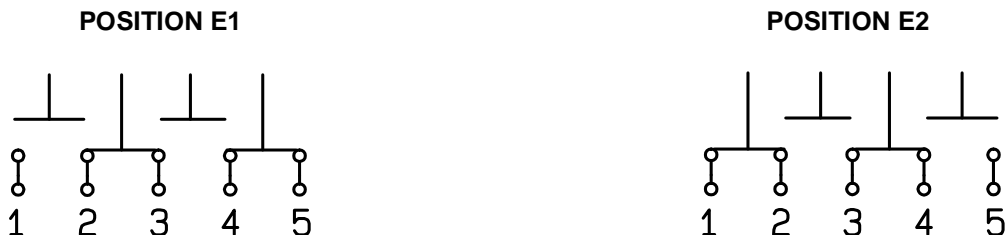

**POSITION INDICATORS**

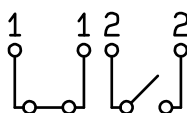

**STATE "11"**

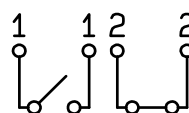

**STATE "22"**

**Standard drive option "1" (Positive common):**

- Connect pin +Vcc to supply.
- Select desired RF path by applying ground to the corresponding "close" pin (Ex: ground pin E1 to switch to position E1. RF path 2-3 and RF path 4-5 closed and RF path 1-2 and RF path 3-4 open).
- To open desired path and close the new RF path, connect ground to the corresponding "close" pin (Ex: ground pin E2 to open RF path 2-3 and 4-5 and close RF path 1-2 and 3-4).

**TTL drive option "2"**

- Connect pin GND to ground.
- Connect pin +Vcc to supply.
- Select (close) desired RF path by applying TTL "High" to the corresponding "drive" pin (Ex: apply TTL "High" to pin E1 to switch to position E1. RF path 2-3 and RF path 4-5 closed and RF path 1-2 and 3-4 open).
- To open desired path and close the new RF path, apply TTL "High" to the "drive" pin which corresponds to the desired RF path. (Ex: apply TTL "High" to pin E2 to open RF path 2-3 and 4-5 and close RF path 1-2 and 3-4).

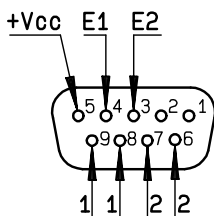

**D-Sub connector**

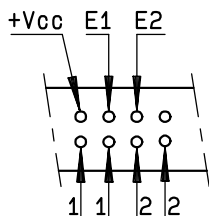

**Solder pins**

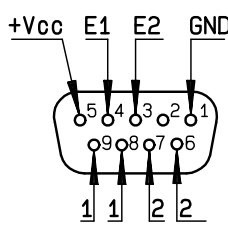

**D-Sub connector**

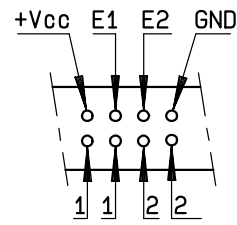

**Solder pins**





All dimensions are in inches/millimetres.

With D-Sub connector

With solder pins

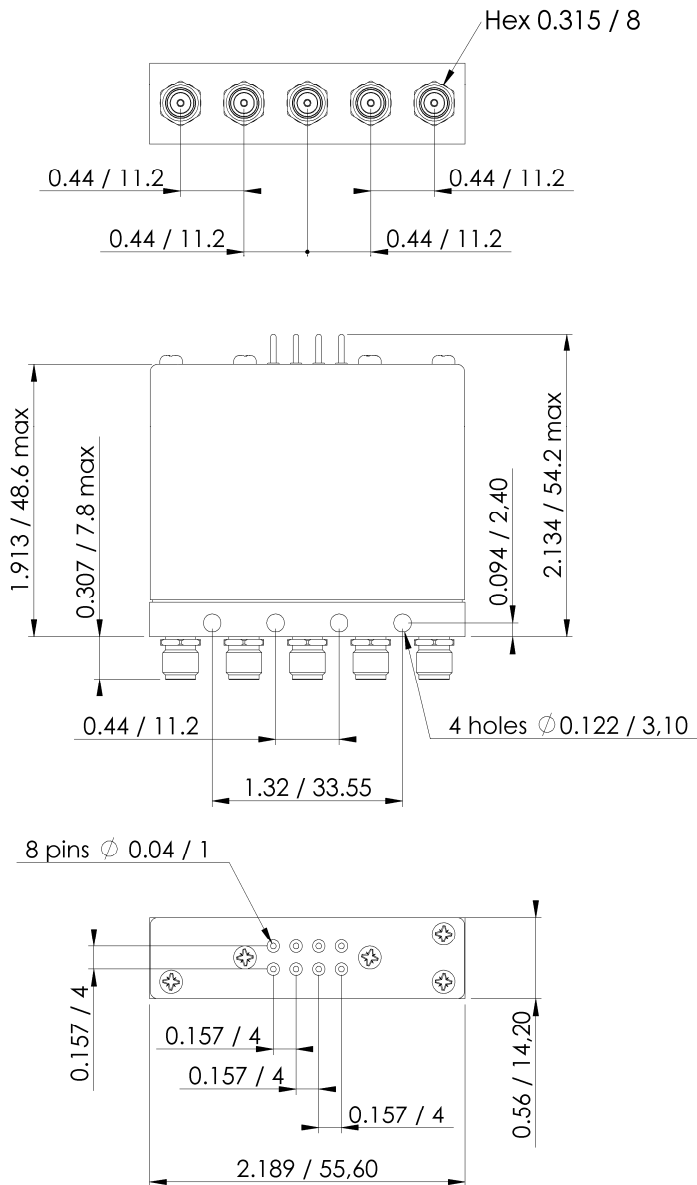
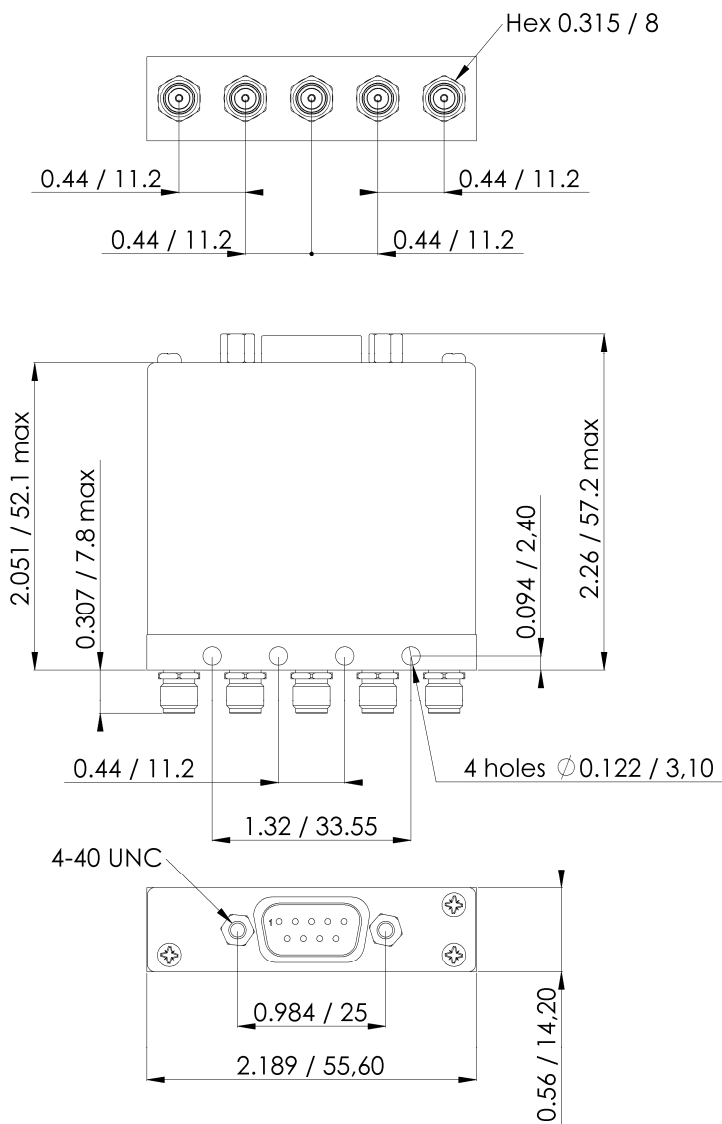



**POWER RATING CHART**

This graph is based on the following conditions :

- Ambient temperature : + 25°C
- Sea level
- V.S.W.R. : 1 and cold switching

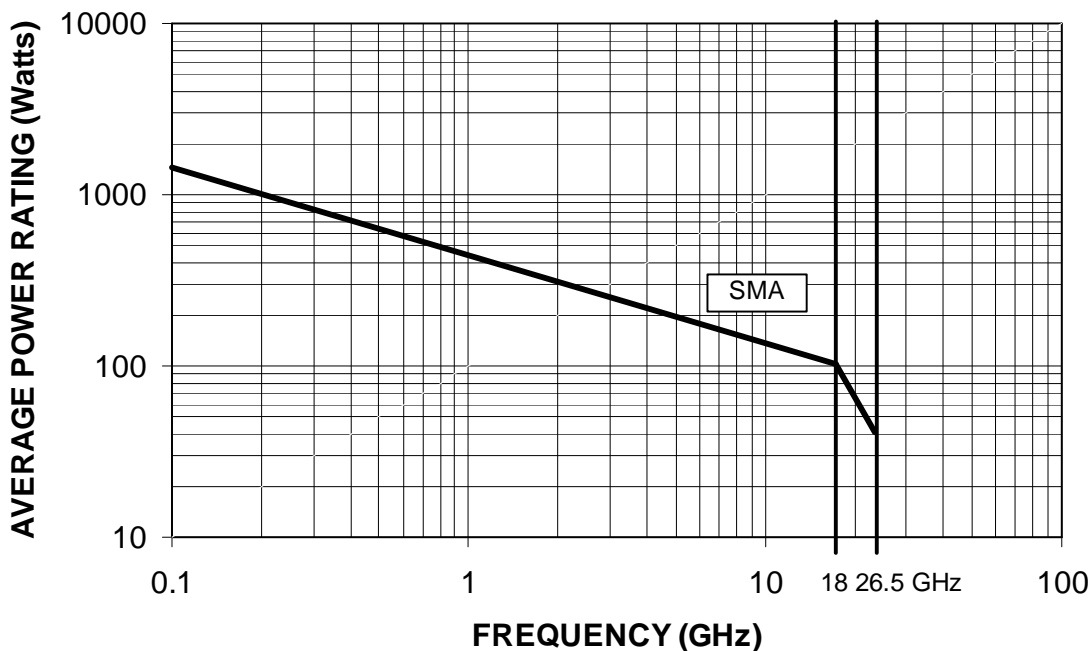

The average power input must be reduced for load V.S.W.R. above 1.

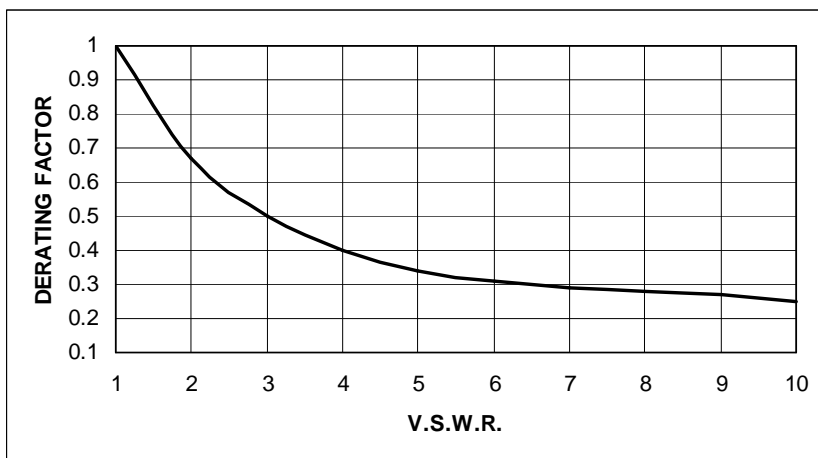

Компания «Life Electronics» занимается поставками электронных компонентов импортного и отечественного производства от производителей и со складов крупных дистрибьюторов Европы, Америки и Азии.

С конца 2013 года компания активно расширяет линейку поставок компонентов по направлению коаксиальный кабель, кварцевые генераторы и конденсаторы (керамические, пленочные, электролитические), за счёт заключения дистрибьюторских договоров

Мы предлагаем:

- Конкурентоспособные цены и скидки постоянным клиентам.
- Специальные условия для постоянных клиентов.
- Подбор аналогов.
- Поставку компонентов в любых объемах, удовлетворяющих вашим потребностям.
- Приемлемые сроки поставки, возможна ускоренная поставка.
- Доставку товара в любую точку России и стран СНГ.
- Комплексную поставку.
- Работу по проектам и поставку образцов.
- Формирование склада под заказчика.
- Сертификаты соответствия на поставляемую продукцию (по желанию клиента).
- Тестирование поставляемой продукции.
- Поставку компонентов, требующих военную и космическую приемку.
- Входной контроль качества.
- Наличие сертификата ISO.

В составе нашей компании организован Конструкторский отдел, призванный помогать разработчикам, и инженерам.

Конструкторский отдел помогает осуществить:

- Регистрацию проекта у производителя компонентов.
- Техническую поддержку проекта.
- Защиту от снятия компонента с производства.
- Оценку стоимости проекта по компонентам.
- Изготовление тестовой платы монтаж и пусконаладочные работы.



Тел: +7 (812) 336 43 04 (многоканальный)

Email: [org@lifeelectronics.ru](mailto:org@lifeelectronics.ru)