



DP3T - SPDT Coaxial Switches DC to 6 GHz, DC to 20 GHz, DC to 26.5 GHz

Radiall's PLATINUM SERIES switches are optimised to perform at a high level over an extended life span. With outstanding RF performances, and a guaranteed Insertion Loss repeatability of 0.03 dB over a life span of 10 million switching cycles. PLATINUM SERIES switches are perfect for automated test and measurement equipment, as well as signal monitoring devices.

PART NUMBER SELECTION

R 595

RF Connectors :
3 : SMA up to 6 GHz
4 : SMA up to 20 GHz
F : SMA up to 26.5 GHz

Type :
3 : Latching
4 : Latching + Indicators
5 : Latching + Self Cut-Off
6 : Latching + Self Cut-Off + Indicators

Actuator Voltage :
3 : 24 Vdc
7 : 15 Vdc

Documentation :
- : Certificate Of Conformity
C : Calibration certificate
R : Calibration certificate + RF curves

Actuator Terminal :
0 : Solder pins
5 : D-Sub connector

Options :
1 : Without option (Positive common)
2 : Compatible TTL driver (high level)

Switch model :
1 : Non terminated SPDT switch
2 : Terminated SPDT switch
3 : Terminated 4 port bypass switch
4 : Non terminated 5 port DP3T switch

PICTURE



**RF PERFORMANCES**

PART NUMBER	R5953-----	R5954-----	R595F-----
Frequency Range GHz	DC to 6	DC to 20	DC to 26.5
Impedance Ohms	50		
Insertion Loss dB (Maximum)	0.20 + (0.45 / 26.5) x frequency (GHz)		
Isolation dB (Minimum)	85	DC to 6 GHz : 85 6 to 12.4 GHz : 75 12.4 to 20 GHz : 65	DC to 6 GHz : 85 6 to 12.4 GHz : 75 12.4 to 20 GHz : 65 20 to 26.5 GHz : 60
V.S.W.R. (Maximum)	1.15	DC to 6 GHz : 1.15 6 to 12.4 GHz : 1.25 12.4 to 18 GHz : 1.30 18 to 20 GHz : 1.60	DC to 6 GHz : 1.15 6 to 12.4 GHz : 1.25 12.4 to 18 GHz : 1.30 18 to 26.5 GHz : 1.60
Repeatability (Up to 10 million cycles measured at 25°C)	0.03 dB maximum	0.03 dB maximum	0.03 dB maximum

TYPICAL RF PERFORMANCES**Insertion Loss and Isolation****V.S.W.R.**

**ADDITIONAL SPECIFICATIONS**

Operating mode		Latching	
Nominal operating voltage (across operating temperature) Vdc			24 (20 / 32) 15 (12 / 20)
Coil resistance (+/-10%)	Ohms	SPDT	350 120
		Terminated SPDT, DP3T, Bypass	175 60
Nominal operating current at 23°C	mA	SPDT	68 125
		Terminated SPDT, DP3T, Bypass	140 250
Average power		RF path Cold switching : see Power Rating Chart on page 12 Hot switching : 1 Watt CW	
		Internal terminations 1 Watt average into 50 Ω	
TTL input	High Level	3 to 7 V	800 μA max at 7 V
	Low Level	0 to 0.8 V	20 μA max at 0.8V
Switching time (max)	ms	15	
Life (min)		10 million cycles	
Connectors		SMA	
Actuator terminals		D-Sub 9 pin female Solder pins	
Weight (max)	g	SPDT	< 60
		Terminated SPDT, DP3T, Bypass	< 100

ENVIRONMENTAL SPECIFICATIONS

Operating temperature range	°C	-25 to +75
Storage temperature range	°C	-55 to +85
Temperature cycling (MIL-STD-202F , Method 107D , Cond.A)	°C	-55 to +85 (10 cycles)
Sine vibration operating (MIL STD 202 , Method 204D , Cond.D)		10-2000 Hz, 20g
Random vibration operating		16.91g (rms) 50-2000 Hz 3min/axis
Shock operating (MIL STD 202 , Method 213B , Cond.G)		50g / 11 ms, sawtooth
Humidity operating		15 to 95% relative humidity
Humidity storage (MIL STD 202 , Method 106E , Cond.E)		65°C, 95% RH, 10 days
Altitude operating		15,000 feet (4,600 meters)
Altitude storage (MIL STD 202 , Method 105C , Cond.B)		50,000 feet (15,240 meters)





SWITCH MODEL 1 : NON TERMINATED SPDT SWITCH

The non terminated SPDT switch is a single pole double throw switch. This switch is "break before make".

RF SCHEMATIC DIAGRAM

POSITION E1

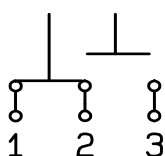

POSITION E2

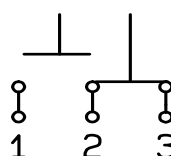

POSITION INDICATORS

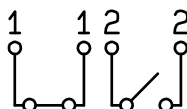

STATE "11"



STATE "22"

Standard drive option "1" (Positive common):

- Connect pin +Vcc to supply.
- Select desired RF path by applying ground to the corresponding "close" pin (Ex: ground pin E1 to switch to position E1. RF path 1-2 closed and RF path 2-3 open).
- To open desired path and close the new RF path, connect ground to the corresponding "close" pin (Ex: ground pin E2 to open RF path 1-2 and close RF path 2-3).

TTL drive option "2"

- Connect pin GND to ground.
- Connect pin +Vcc to supply
- Select (close) desired RF path by applying TTL "High" to the corresponding "drive" pin (Ex: apply TTL "High" to pin E1 to switch to position E1. RF path 1-2 closed and RF path 2-3 open).
- To open desired path and close the new RF path, apply TTL "High" to the "drive" pin which corresponds to the desired RF path. (Ex: apply TTL "High" to pin E2 to open RF path 1-2 and close RF path 2-3).



D-Sub connector



Solder pins

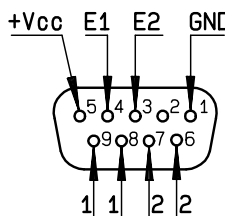

D-Sub connector



Solder pins



All dimensions are in inches/millimetres.

With D-Sub connector



With solder pins

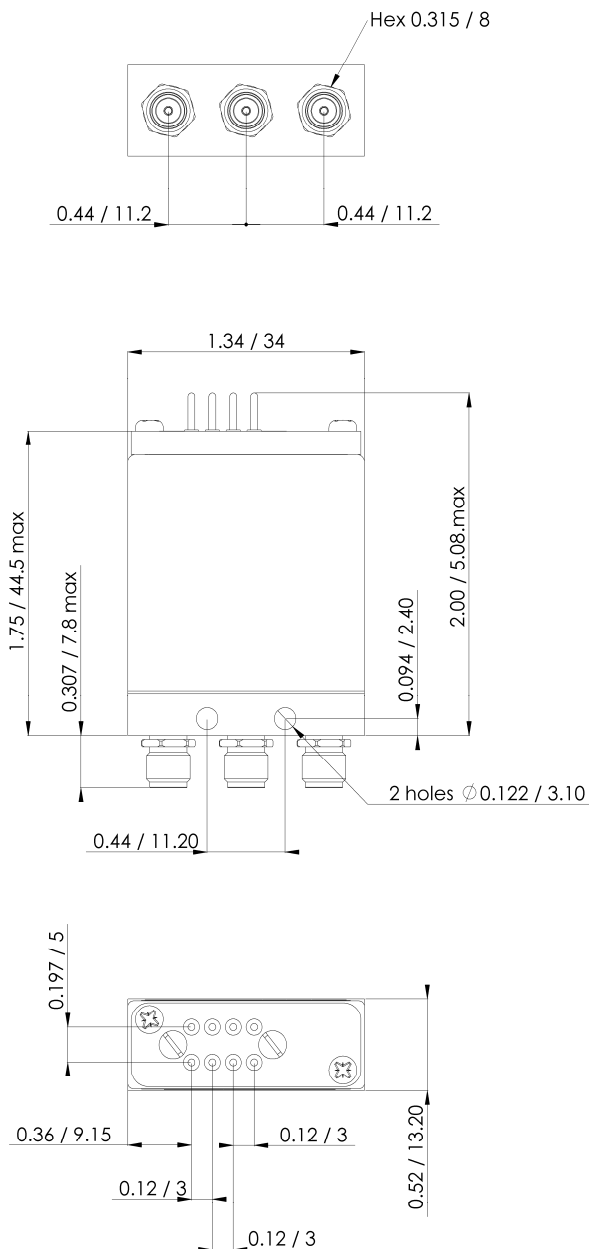



SWITCH MODEL 2 : TERMINATED SPDT SWITCH

The terminated SPDT switch is a single pole double throw switch. The unused ports are terminated into 50 ohms. This switch is "break before make".

RF SCHEMATIC DIAGRAM



POSITION INDICATORS



STATE "11"



STATE "22"

Standard drive option "1" (Positive common):

- Connect pin +Vcc to supply.
- Select desired RF path by applying ground to the corresponding "close" pin (Ex: ground pin E1 to switch to position E1. RF path 1-2 closed and RF path 2-3 open).
- To open desired path and close the new RF path, connect ground to the corresponding "close" pin (Ex: ground pin E2 to open RF path 1-2 and close RF path 2-3).

TTL drive option "2"

- Connect pin GND to ground.
- Connect pin +Vcc to supply
- Select (close) desired RF path by applying TTL "High" to the corresponding "drive" pin (Ex: apply TTL "High" to pin E1 to switch to position E1. RF path 1-2 closed and RF path 2-3 open).
- To open desired path and close the new RF path, apply TTL "High" to the "drive" pin which corresponds to the desired RF path. (Ex: apply TTL "High" to pin E2 to open RF path 1-2 and close RF path 2-3).



D-Sub connector



Solder pins

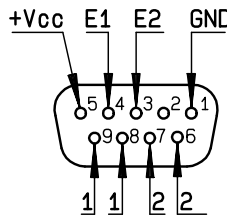

D-Sub connector



Solder pins



All dimensions are in inches/millimetres.

With D-Sub connector

With solder pins





SWITCH MODEL 3 : TERMINATED 4 PORT BYPASS SWITCH

The terminated 4 port bypass switch can terminate into 50 ohms the device under test. These switches are "break before make".

RF SCHEMATIC DIAGRAM



POSITION INDICATORS



Standard drive option "1" (Positive common):

- Connect pin +Vcc to supply.
- Select desired RF path by applying ground to the corresponding "close" pin (Ex: ground pin E1 to switch to position E1. RF path 1-2 and RF path 3-4 closed and RF path 2-3 open).
- To open desired path and close the new RF path, connect ground to the corresponding "close" pin (Ex: ground pin E2 to open RF path 1-2 and 3-4 and close RF path 2-3).

TTL drive option "2"

- Connect pin GND to ground.
- Connect pin +Vcc to supply.
- Select (close) desired RF path by applying TTL "High" to the corresponding "drive" pin (Ex: apply TTL "High" to pin E1 to switch to position E1. RF path 1-2 and 3-4 closed and RF path 2-3 open).
- To open desired path and close the new RF path, apply TTL "High" to the "drive" pin which corresponds to the desired RF path. (Ex: apply TTL "High" to pin E2 to open RF path 1-2 and 3-4 and close RF path 2-3).

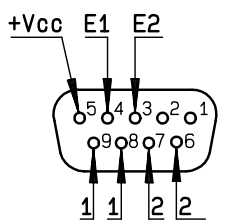

D-Sub connector

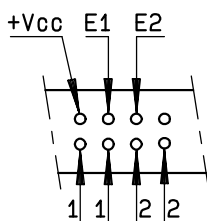

Solder pins

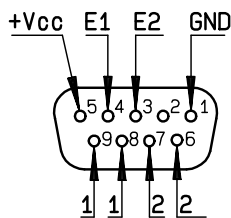

D-Sub connector

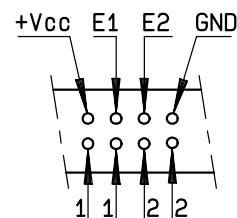

Solder pins



All dimensions are in inches/millimetres.

With D-Sub connector

With solder pins





SWITCH MODEL 4 : NON TERMINATED 5 PORT DP3T SWITCH

The non terminated 5 port DP3T switch can used as SPDT with high power terminations, as a bypass switch. In this application, the fifth port can be terminated externally with a high power termination. These switches are "break before make".

RF SCHEMATIC DIAGRAM



POSITION INDICATORS

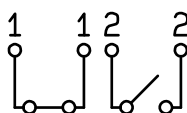

STATE "11"



STATE "22"

Standard drive option "1" (Positive common):

- Connect pin +Vcc to supply.
- Select desired RF path by applying ground to the corresponding "close" pin (Ex: ground pin E1 to switch to position E1. RF path 2-3 and RF path 4-5 closed and RF path 1-2 and RF path 3-4 open).
- To open desired path and close the new RF path, connect ground to the corresponding "close" pin (Ex: ground pin E2 to open RF path 2-3 and 4-5 and close RF path 1-2 and 3-4).

TTL drive option "2"

- Connect pin GND to ground.
- Connect pin +Vcc to supply.
- Select (close) desired RF path by applying TTL "High" to the corresponding "drive" pin (Ex: apply TTL "High" to pin E1 to switch to position E1. RF path 2-3 and RF path 4-5 closed and RF path 1-2 and 3-4 open).
- To open desired path and close the new RF path, apply TTL "High" to the "drive" pin which corresponds to the desired RF path. (Ex: apply TTL "High" to pin E2 to open RF path 2-3 and 4-5 and close RF path 1-2 and 3-4).

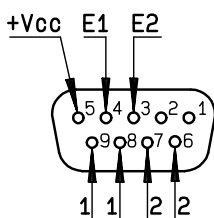

D-Sub connector



Solder pins

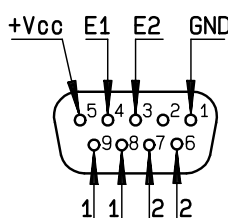

D-Sub connector

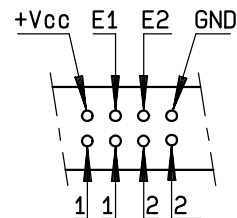

Solder pins





All dimensions are in inches/millimetres.

With D-Sub connector

With solder pins

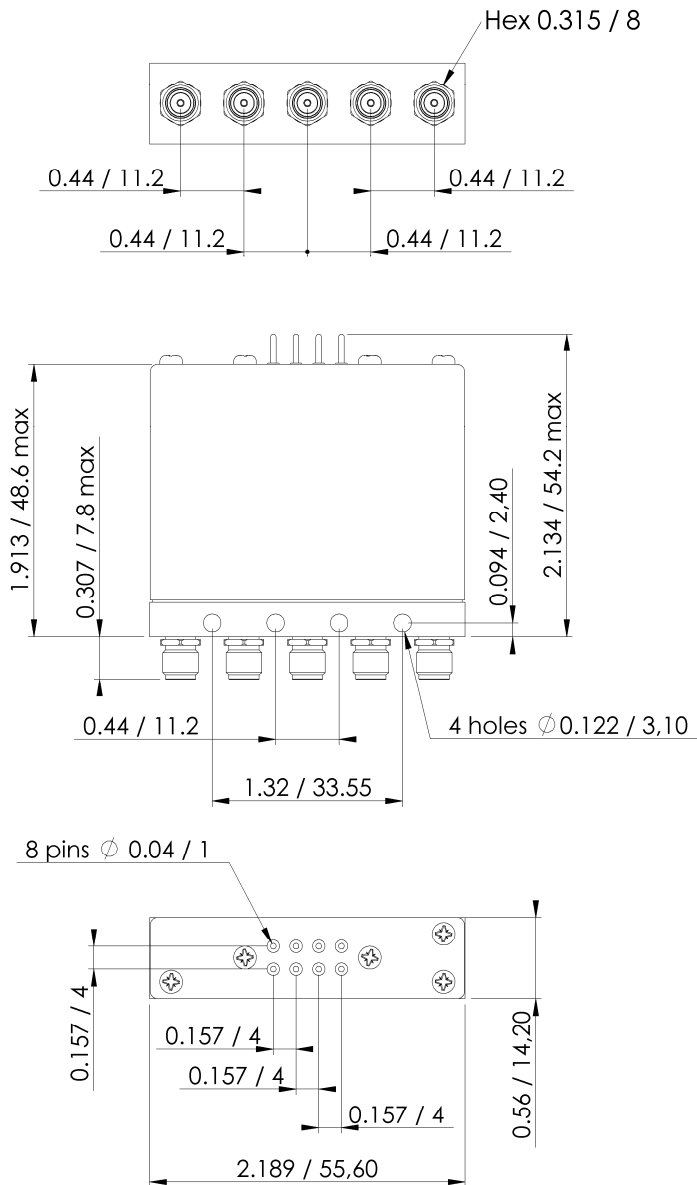



POWER RATING CHART

This graph is based on the following conditions :

- Ambient temperature : + 25°C
- Sea level
- V.S.W.R. : 1 and cold switching



The average power input must be reduced for load V.S.W.R. above 1.



Компания «Life Electronics» занимается поставками электронных компонентов импортного и отечественного производства от производителей и со складов крупных дистрибьюторов Европы, Америки и Азии.

С конца 2013 года компания активно расширяет линейку поставок компонентов по направлению коаксиальный кабель, кварцевые генераторы и конденсаторы (керамические, пленочные, электролитические), за счёт заключения дистрибьюторских договоров

Мы предлагаем:

- Конкуренспособные цены и скидки постоянным клиентам.
- Специальные условия для постоянных клиентов.
- Подбор аналогов.
- Поставку компонентов в любых объемах, удовлетворяющих вашим потребностям.
- Приемлемые сроки поставки, возможна ускоренная поставка.
- Доставку товара в любую точку России и стран СНГ.
- Комплексную поставку.
- Работу по проектам и поставку образцов.
- Формирование склада под заказчика.
- Сертификаты соответствия на поставляемую продукцию (по желанию клиента).
- Тестирование поставляемой продукции.
- Поставку компонентов, требующих военную и космическую приемку.
- Входной контроль качества.
- Наличие сертификата ISO.

В составе нашей компании организован Конструкторский отдел, призванный помогать разработчикам, и инженерам.

Конструкторский отдел помогает осуществить:

- Регистрацию проекта у производителя компонентов.
- Техническую поддержку проекта.
- Защиту от снятия компонента с производства.
- Оценку стоимости проекта по компонентам.
- Изготовление тестовой платы монтаж и пусконаладочные работы.



Тел: +7 (812) 336 43 04 (многоканальный)

Email: org@lifeelectronics.ru