



Is Now Part of



**ON Semiconductor®**

To learn more about ON Semiconductor, please visit our website at  
[www.onsemi.com](http://www.onsemi.com)

Please note: As part of the Fairchild Semiconductor integration, some of the Fairchild orderable part numbers will need to change in order to meet ON Semiconductor's system requirements. Since the ON Semiconductor product management systems do not have the ability to manage part nomenclature that utilizes an underscore (\_), the underscore (\_) in the Fairchild part numbers will be changed to a dash (-). This document may contain device numbers with an underscore (\_). Please check the ON Semiconductor website to verify the updated device numbers. The most current and up-to-date ordering information can be found at [www.onsemi.com](http://www.onsemi.com). Please email any questions regarding the system integration to [Fairchild\\_questions@onsemi.com](mailto:Fairchild_questions@onsemi.com).

ON Semiconductor and the ON Semiconductor logo are trademarks of Semiconductor Components Industries, LLC dba ON Semiconductor or its subsidiaries in the United States and/or other countries. ON Semiconductor owns the rights to a number of patents, trademarks, copyrights, trade secrets, and other intellectual property. A listing of ON Semiconductor's product/patent coverage may be accessed at [www.onsemi.com/site/pdf/Patent-Marking.pdf](http://www.onsemi.com/site/pdf/Patent-Marking.pdf). ON Semiconductor reserves the right to make changes without further notice to any products herein. ON Semiconductor makes no warranty, representation or guarantee regarding the suitability of its products for any particular purpose, nor does ON Semiconductor assume any liability arising out of the application or use of any product or circuit, and specifically disclaims any and all liability, including without limitation special, consequential or incidental damages. Buyer is responsible for its products and applications using ON Semiconductor products, including compliance with all laws, regulations and safety requirements or standards, regardless of any support or applications information provided by ON Semiconductor. "Typical" parameters which may be provided in ON Semiconductor data sheets and/or specifications can and do vary in different applications and actual performance may vary over time. All operating parameters, including "Typicals" must be validated for each customer application by customer's technical experts. ON Semiconductor does not convey any license under its patent rights nor the rights of others. ON Semiconductor products are not designed, intended, or authorized for use as a critical component in life support systems or any FDA Class 3 medical devices or medical devices with a same or similar classification in a foreign jurisdiction or any devices intended for implantation in the human body. Should Buyer purchase or use ON Semiconductor products for any such unintended or unauthorized application, Buyer shall indemnify and hold ON Semiconductor and its officers, employees, subsidiaries, affiliates, and distributors harmless against all claims, costs, damages, and expenses, and reasonable attorney fees arising out of, directly or indirectly, any claim of personal injury or death associated with such unintended or unauthorized use, even if such claim alleges that ON Semiconductor was negligent regarding the design or manufacture of the part. ON Semiconductor is an Equal Opportunity/Affirmative Action Employer. This literature is subject to all applicable copyright laws and is not for resale in any manner.



# FPF1007-FPF1009 IntelliMAX™ Advanced Load Products

## Features

- 1.2 to 5.5 V Input Voltage Range
- Typical  $R_{ON} = 30\text{ m}\Omega$  at  $V_{IN} = 5.5\text{ V}$
- Typical  $R_{ON} = 40\text{ m}\Omega$  at  $V_{IN} = 3.3\text{ V}$
- Fixed Three Different Turn-on Rise Time  $10\text{ }\mu\text{s} / 80\text{ }\mu\text{s} / 1\text{ ms}$
- Low  $< 10\text{ }\mu\text{A}$  at  $V_{IN} = 3.3\text{ V}$  Quiescent Current
- Internal ON Pin Pull Down
- Output Discharge Function
- ESD Protection above 8000 V HBM and 2000 V CDM
- RoHS Compliant

## Applications

- PDAs
- Cell Phones
- GPS Devices
- MP3 Players
- Digital Cameras
- Peripheral Ports
- Hot-Swap Supplies
- Notebook Computers



## General Description

The FPF1007/8/9 are low  $R_{DS}$  P-Channel MOSFET load switches offered in a selection of  $10\text{ }\mu\text{s}$ ,  $80\text{ }\mu\text{s}$ , and  $1\text{ ms}$  slew rate turn-on options for transient / in-rush current control. To support trends in mobile application requirements, the minimum operating input voltage has been reduced down to  $1.2\text{ V}$ , the input current leakage has been minimized to extend battery life, and the ESD-protection has been designed to withstand a minimum of  $8\text{ kV}$  (HBM) and  $2\text{ kV}$  (CDM).

The switch is controlled by an active-high logic input (ON pin), allowing direct interface with a low-voltage control signal. An internal ON pin pull-down resistor protects against unintentional device turn-on in the initial state. An on-chip pull-down resistor on the output is enabled when the switch is turned-off and provides quick, robust discharge of the output load.



## Ordering Information

Part	Switch $R_{ON}$ at 5.5 V [Typ.]	Rise Time [Typ.]	Output Discharge [Typ.]	ON Pin Activity
FPF1007	$30\text{ m}\Omega$ , PMOS	$10\text{ }\mu\text{s}$	$60\text{ }\Omega$	Active HIGH
FPF1008	$30\text{ m}\Omega$ , PMOS	$80\text{ }\mu\text{s}$	$60\text{ }\Omega$	Active HIGH
FPF1009	$30\text{ m}\Omega$ , PMOS	$1\text{ ms}$	$60\text{ }\Omega$	Active HIGH

### Typical Application Circuit

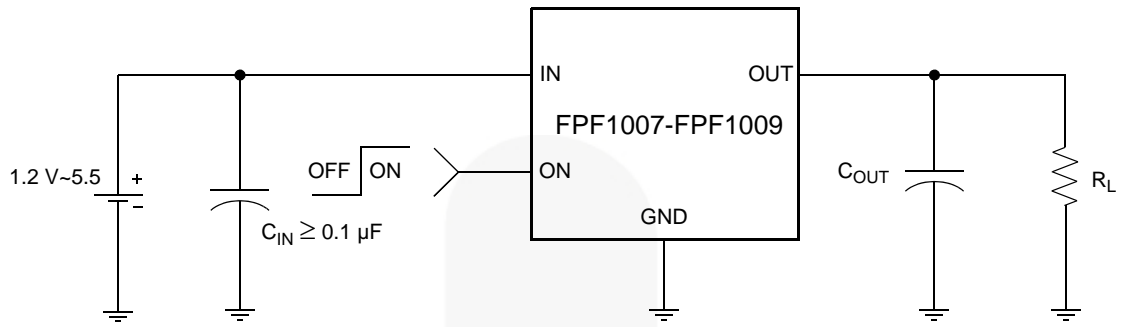

### Functional Block Diagram

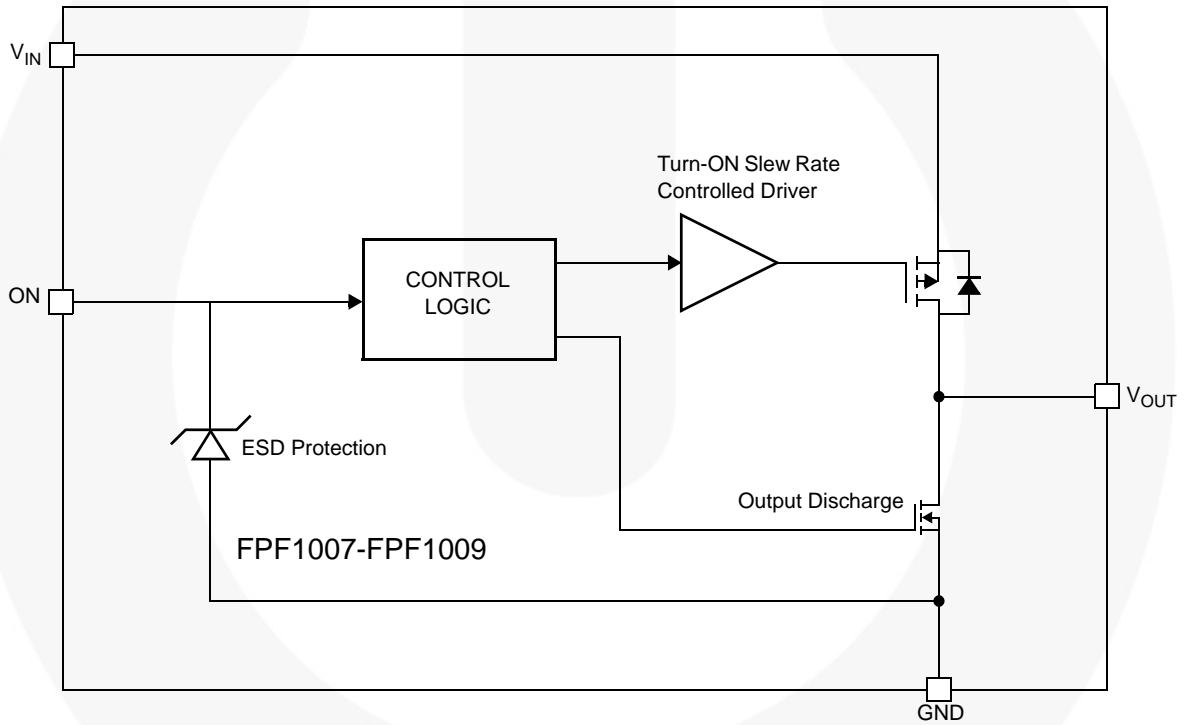

## Pin Configuration

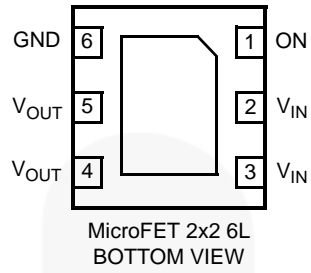

## Pin Description

Pin	Name	Function
4, 5	$V_{OUT}$	Switch Output: Output of the power switch
2, 3	$V_{IN}$	Supply Input: Input to the power switch and the supply voltage for the IC
6	GND	Ground
1	ON	ON/OFF Control Input

## Absolute Maximum Ratings

Parameter	Min.	Max.	Unit
$V_{IN}$ , $V_{OUT}$ , ON to GND	-0.3	6.0	V
Maximum Continuous Switch Current		1.5	A
Power Dissipation at $T_A = 25^\circ\text{C}^{(1)}$		1.2	W
Storage Junction Temperature	-65	+150	$^\circ\text{C}$
Operating Temperature Range	-40	+85	$^\circ\text{C}$
Thermal Resistance, Junction to Ambient		86	$^\circ\text{C/W}$
Electrostatic Discharge Protection	HBM	8000	V
	CDM	2000	V

**Note:**

Package power dissipation on 1-square inch pad, 2 oz. copper board.

## Recommended Operating Range

Parameter	Min.	Max.	Unit
$V_{IN}$	1.2	5.5	V
Ambient Operating Temperature, $T_A$	-40	+85	$^\circ\text{C}$

## Electrical Characteristics

$V_{IN} = 1.2\text{ V to } 5.5\text{ V}$ ,  $T_A = -40\text{ to } +85^\circ\text{C}$  unless otherwise noted. Typical values are at  $V_{IN} = 3.3\text{ V}$  and  $T_A = 25^\circ\text{C}$ .

Parameter	Symbol	Conditions	Min.	Typ.	Max.	Units
<b>Basic Operation</b>						
Operating Voltage	$V_{IN}$		1.2		5.5	V
Quiescent Current	$I_Q$	$I_{OUT} = 0\text{ mA}$ , $V_{IN} = 3.3\text{ V}$ , $V_{ON} = \text{Enabled}$		8		$\mu\text{A}$
		$I_{OUT} = 0\text{ mA}$ , $V_{IN} = 5.5\text{ V}$ , $V_{ON} = \text{Enabled}$			15	
Off Supply Current	$I_{Q(\text{off})}$	$V_{ON} = \text{GND}$ , $V_{OUT} = \text{OPEN}$			1	$\mu\text{A}$
Off Switch Current	$I_{SD(\text{off})}$	$V_{ON} = \text{GND}$ , $V_{OUT} = \text{GND}$		0.1	1.0	$\mu\text{A}$
On-Resistance	$R_{ON}$	$V_{IN} = 5.5\text{ V}$ , $I_{OUT} = 200\text{ mA}$ , $T_A = 25^\circ\text{C}$		30	40	$\text{m}\Omega$
		$V_{IN} = 3.3\text{ V}$ , $I_{OUT} = 200\text{ mA}$ , $T_A = 25^\circ\text{C}$		40	55	
		$V_{IN} = 1.5\text{ V}$ , $I_{OUT} = 200\text{ mA}$ , $T_A = 25^\circ\text{C}$		100	130	
		$V_{IN} = 1.2\text{ V}$ , $I_{OUT} = 200\text{ mA}$ , $T_A = 25^\circ\text{C}$		175	250	
		$V_{IN} = 3.3\text{ V}$ , $I_{OUT} = 200\text{ mA}$ , $T_A = -40^\circ\text{C to } +85^\circ\text{C}$	20		65	
Output Pull Down Resistance	$R_{PD}$	$V_{IN} = 3.3\text{ V}$ , $V_{ON} = 0\text{ V}$ , $T_A = 25^\circ\text{C}$		60		$\Omega$
ON Input Logic Low Voltage	$V_{IL}$	$V_{IN} = 1.2\text{ V to } 5.5\text{ V}$			0.4	V
ON Input Logic High Voltage	$V_{IH}$	$V_{IN} = 1.2\text{ V to } 5.5\text{ V}$	1			V
ON Input Leakage (On)		$V_{ON} = V_{IN} = 5.5\text{ V}$			10	$\mu\text{A}$
ON Input Leakage (Off)		$V_{ON} = \text{GND}$			1	$\mu\text{A}$
<b>Dynamic</b>						
<b>FPF1007</b>						
Turn On	$t_{ON}$	$V_{IN} = 3.3\text{ V}$ , $R_L = 500\ \Omega$ , $R_{L\_CHIP} = 60\ \Omega$ , $C_{OUT} = 0.1\ \mu\text{F}$ , $T_A = 25^\circ\text{C}$		12		$\mu\text{s}$
Rise Time	$t_R$			10		$\mu\text{s}$
Turn Off	$t_{OFF}$			40		$\mu\text{s}$
Fall Time	$t_F$			15		$\mu\text{s}$
<b>FPF1008</b>						
Turn On	$t_{ON}$	$V_{IN} = 3.3\text{ V}$ , $R_L = 500\ \Omega$ , $R_{L\_CHIP} = 60\ \Omega$ , $C_{OUT} = 0.1\ \mu\text{F}$ , $T_A = 25^\circ\text{C}$		125		$\mu\text{s}$
Rise Time	$t_R$			80		$\mu\text{s}$
Turn Off	$t_{OFF}$			40		$\mu\text{s}$
Fall Time	$t_F$			15		$\mu\text{s}$
<b>FPF1009</b>						
Turn On	$t_{ON}$	$V_{IN} = 3.3\text{ V}$ , $R_L = 500\ \Omega$ , $R_{L\_CHIP} = 60\ \Omega$ , $C_{OUT} = 0.1\ \mu\text{F}$ , $T_A = 25^\circ\text{C}$		2		ms
Rise Time	$t_R$			1		ms
Turn Off	$t_{OFF}$			40		$\mu\text{s}$
Fall Time	$t_F$			15		$\mu\text{s}$

## Typical Characteristics

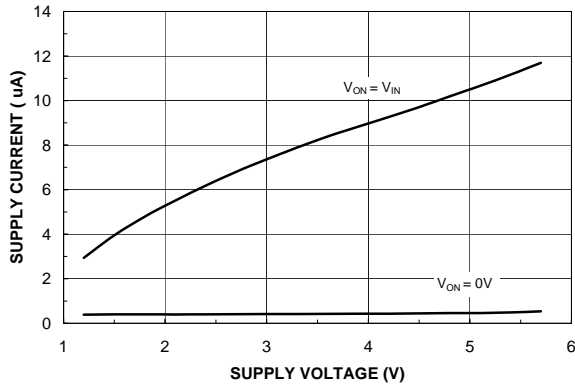

Figure 1. Quiescent Current vs. Input Voltage

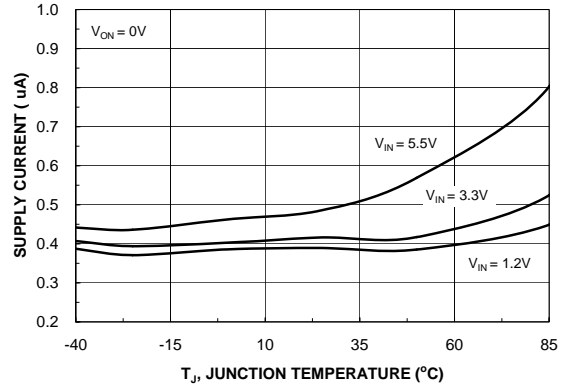

Figure 2. Quiescent Current vs. Temperature

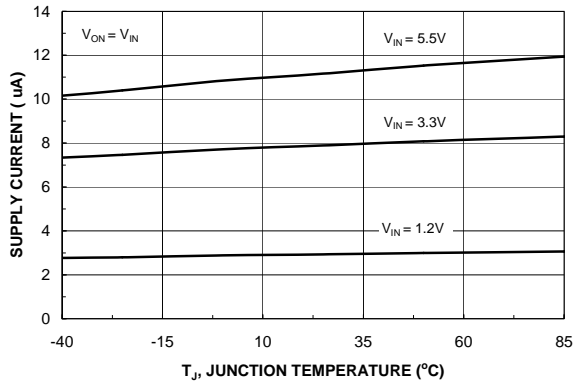

Figure 3. Quiescent Current vs. Temperature

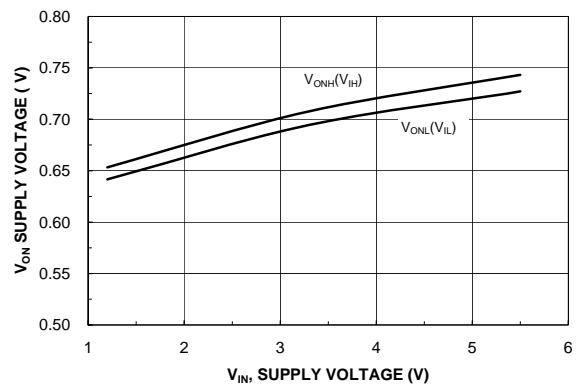

Figure 4.  $V_{ON}$  Voltage vs. Input Voltage

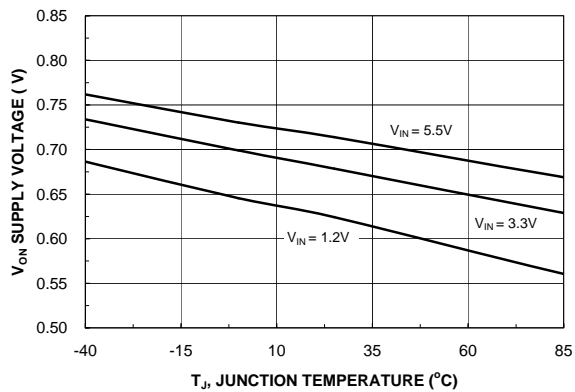

Figure 5.  $V_{ON}$  Low Voltage vs. Temperature

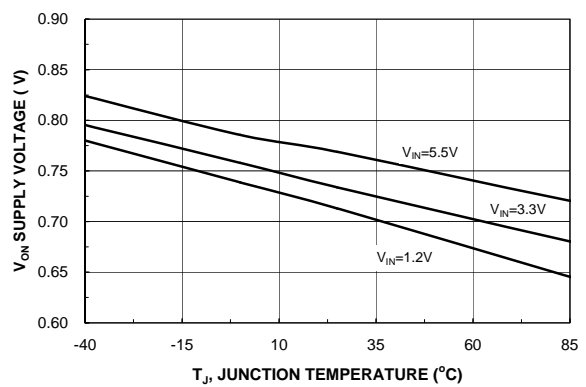

Figure 6.  $V_{ON}$  High Voltage vs. Temperature

## Typical Characteristics

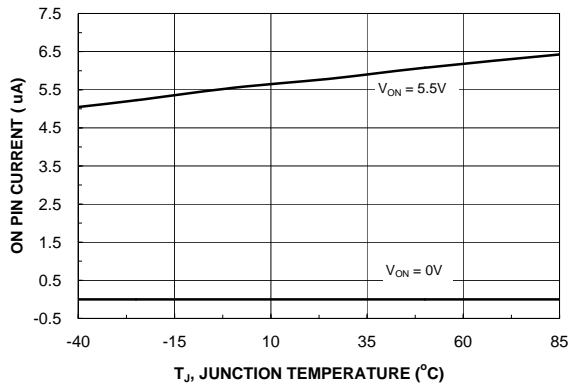

Figure 7. On Pin Current vs. Temperature

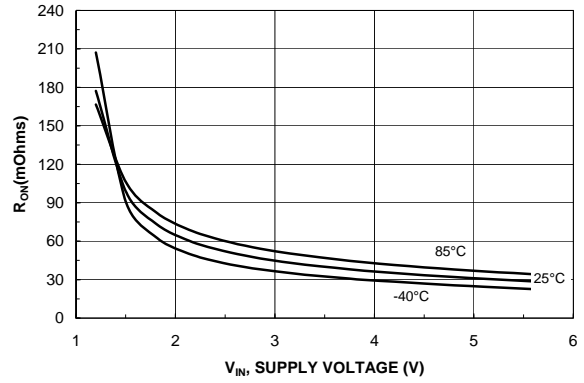

Figure 8.  $R_{ON}$  vs.  $V_{IN}$

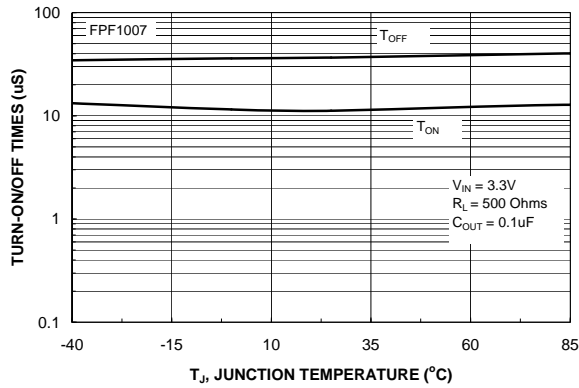

Figure 9. FPF1007  $t_{ON}$  /  $t_{OFF}$  vs. Temperature

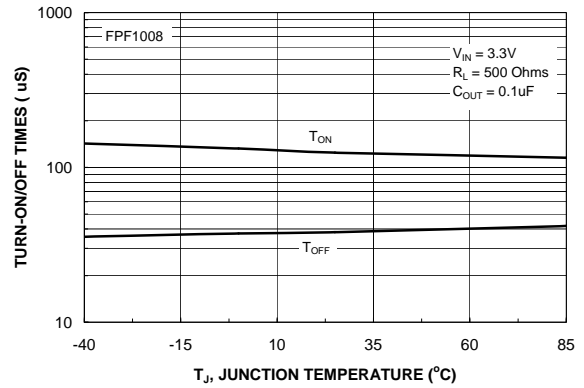

Figure 10. FPF1008  $t_{ON}$  /  $t_{OFF}$  vs. Temperature

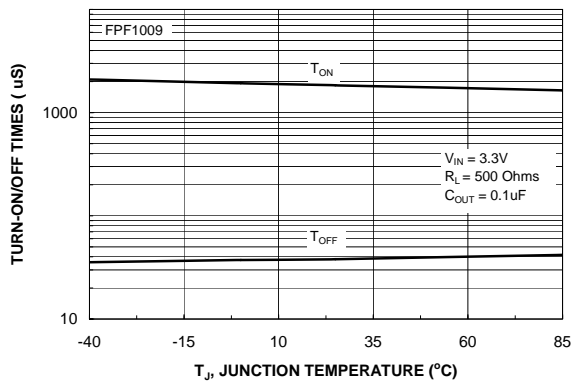

Figure 11. FPF1009  $t_{ON}$  /  $t_{OFF}$  vs. Temperature

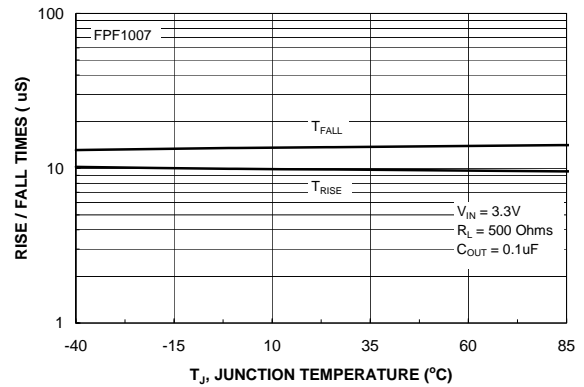

Figure 12. FPF1007  $t_{RISE}$  /  $t_{FALL}$  vs. Temperature



## Typical Characteristics

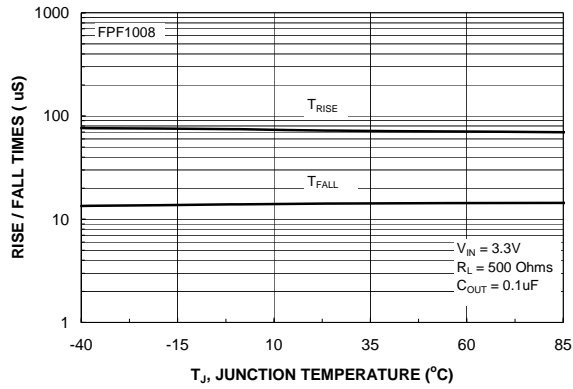

Figure 13. FPF1008  $t_{RISE}$  /  $t_{FALL}$  vs. Temperature

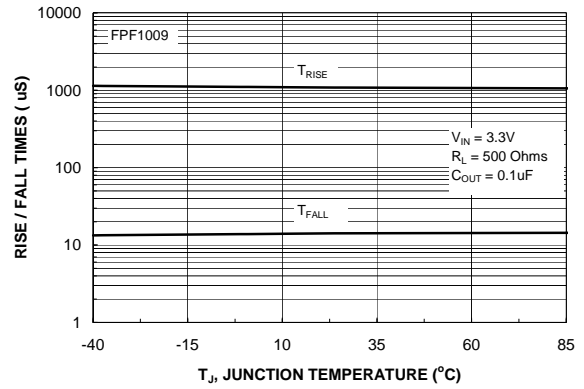

Figure 14. FPF1009  $t_{RISE}$  /  $t_{FALL}$  vs. Temperature

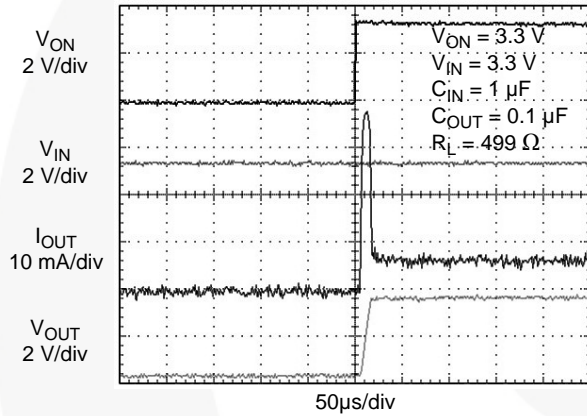

Figure 15. FPF1007 Turn-On Response

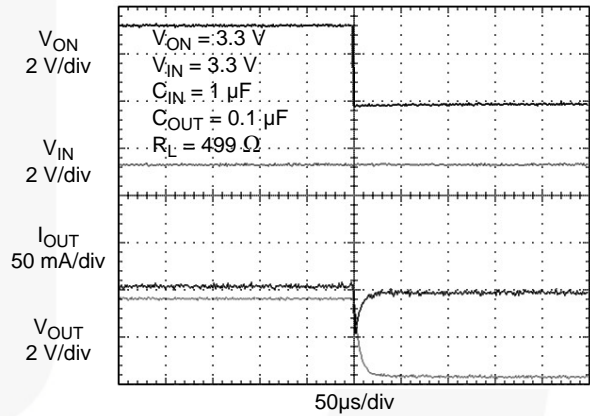

Figure 16. FPF1007 Turn-Off Response  
Load current discharged through on-chip output discharge resistor

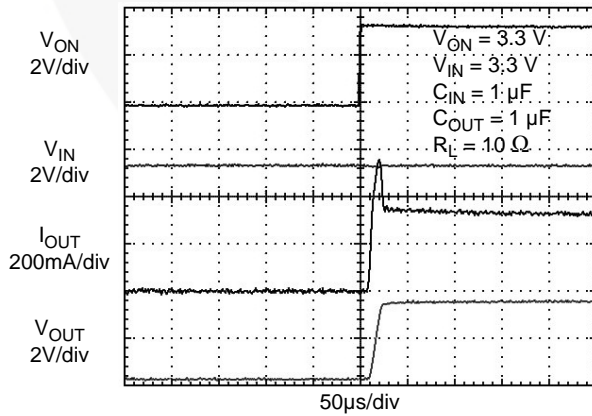

Figure 17. FPF1007 Turn-On Response ( $C_{OUT} = 1 \mu F$ )

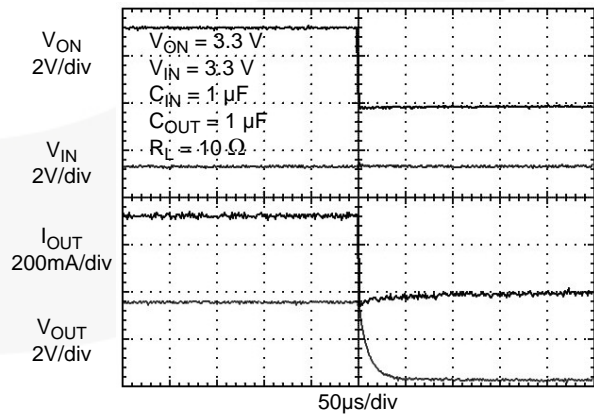

Figure 18. FPF1007 Turn-Off Response

## Typical Characteristics

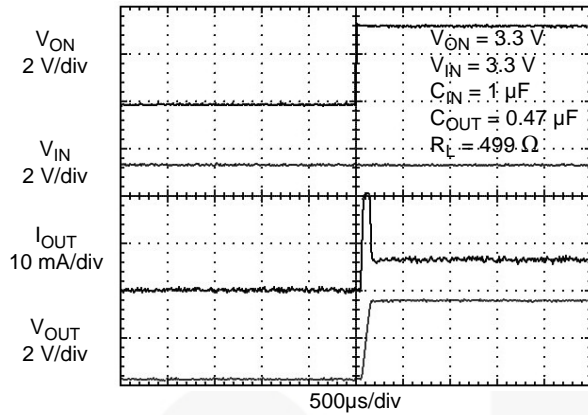

Figure 19. FPF1008 Turn-On Response

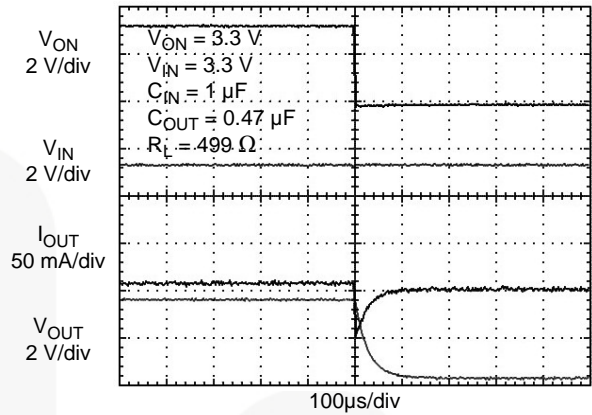

Figure 20. FPF1008 Turn-Off Response  
Load current discharged through on-chip output discharge resistor

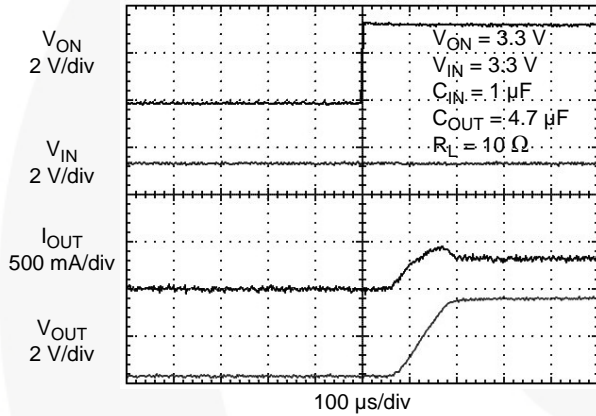

Figure 21. FPF1008 Turn-On Response ( $C_{OUT} = 4.7\text{ }\mu\text{F}$ )

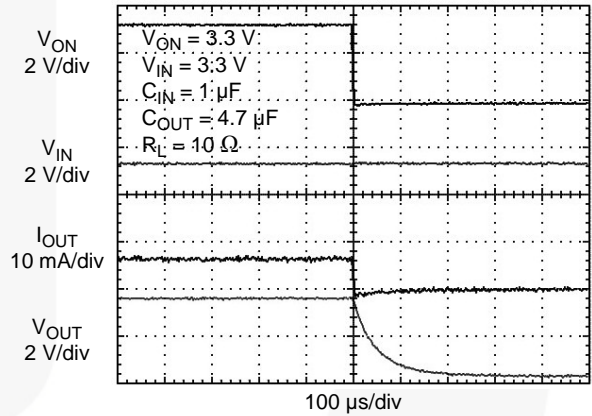

Figure 22. FPF1008 Turn-Off Response

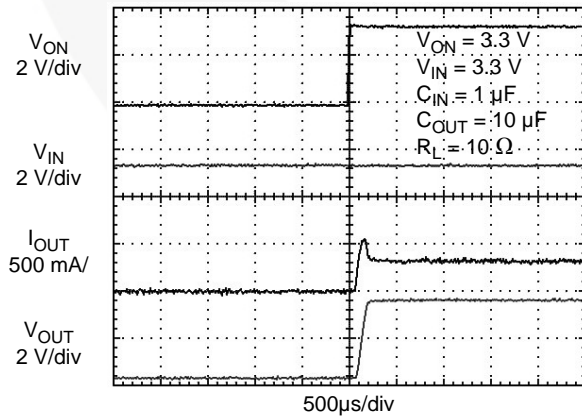

Figure 23. FPF1008 Turn-On Response ( $C_{OUT} = 10\text{ }\mu\text{F}$ )

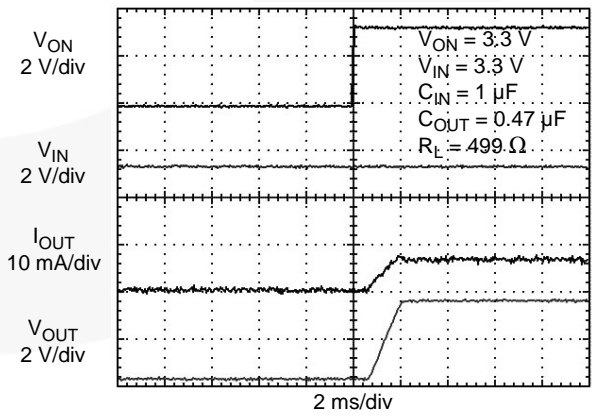

Figure 24. FPF1009 Turn-On Response

## Typical Characteristics

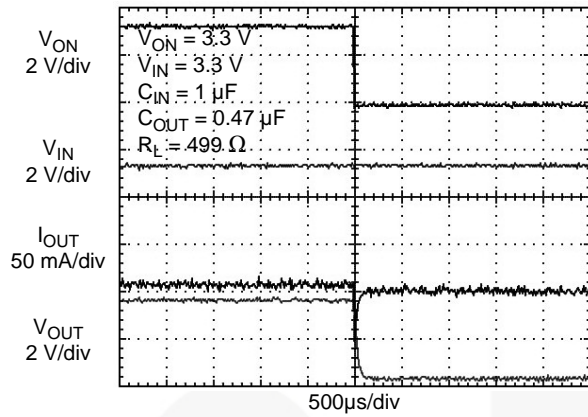

Figure 25. FPF1009 Turn-Off Response  
Load current discharged through on-chip output discharge resistor

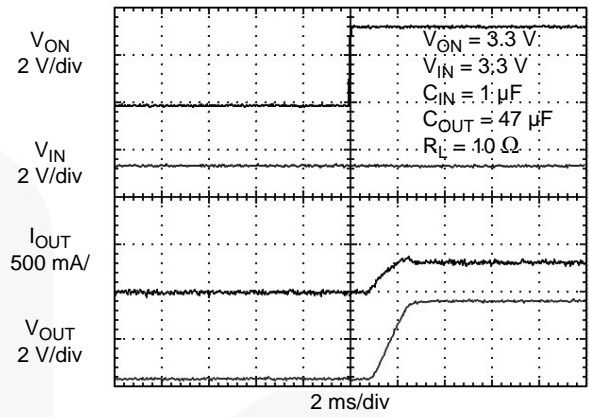

Figure 26. FPF1009 Turn-On Response ( $C_{OUT} = 47 \mu\text{F}$ )

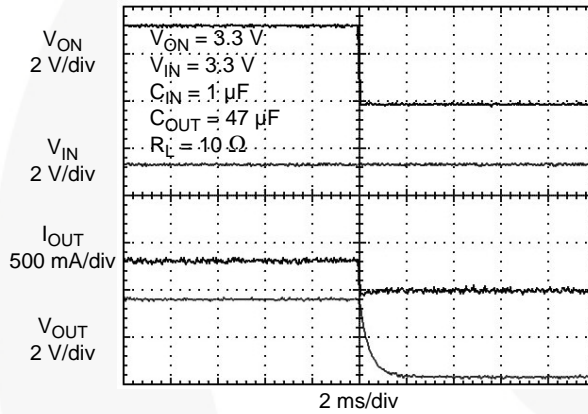

Figure 27. FPF1009 Turn-Off Response

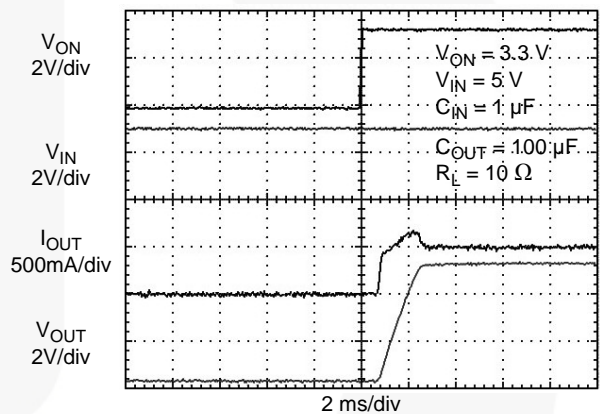
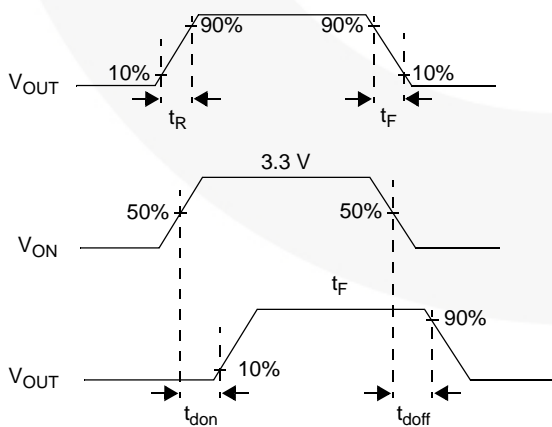

Figure 28. FPF1009 Turn-On Response  
( $C_{OUT} = 100 \mu\text{F}$ ,  $V_{IN} = 5\text{V}$ )

## Timing Diagram



where:

- $t_{ON}$  = Turn-On Time
- $t_{OFF}$  = Turn-Off Time
- $t_{don}$  = Turn-On Delay Time
- $t_{doff}$  = Turn-Off Delay Time
- $t_R$  = Rise Time
- $t_F$  =  $V_{OUT}$  Fall Time
- $t_{ON} = t_R + t_{don}$
- $t_{OFF} = t_F + t_{doff}$



ON Semiconductor and  are trademarks of Semiconductor Components Industries, LLC dba ON Semiconductor or its subsidiaries in the United States and/or other countries. ON Semiconductor owns the rights to a number of patents, trademarks, copyrights, trade secrets, and other intellectual property. A listing of ON Semiconductor's product/patent coverage may be accessed at [www.onsemi.com/site/pdf/Patent-Marking.pdf](http://www.onsemi.com/site/pdf/Patent-Marking.pdf). ON Semiconductor reserves the right to make changes without further notice to any products herein. ON Semiconductor makes no warranty, representation or guarantee regarding the suitability of its products for any particular purpose, nor does ON Semiconductor assume any liability arising out of the application or use of any product or circuit, and specifically disclaims any and all liability, including without limitation special, consequential or incidental damages. Buyer is responsible for its products and applications using ON Semiconductor products, including compliance with all laws, regulations and safety requirements or standards, regardless of any support or applications information provided by ON Semiconductor. "Typical" parameters which may be provided in ON Semiconductor data sheets and/or specifications can and do vary in different applications and actual performance may vary over time. All operating parameters, including "Typicals" must be validated for each customer application by customer's technical experts. ON Semiconductor does not convey any license under its patent rights nor the rights of others. ON Semiconductor products are not designed, intended, or authorized for use as a critical component in life support systems or any FDA Class 3 medical devices or medical devices with a same or similar classification in a foreign jurisdiction or any devices intended for implantation in the human body. Should Buyer purchase or use ON Semiconductor products for any such unintended or unauthorized application, Buyer shall indemnify and hold ON Semiconductor and its officers, employees, subsidiaries, affiliates, and distributors harmless against all claims, costs, damages, and expenses, and reasonable attorney fees arising out of, directly or indirectly, any claim of personal injury or death associated with such unintended or unauthorized use, even if such claim alleges that ON Semiconductor was negligent regarding the design or manufacture of the part. ON Semiconductor is an Equal Opportunity/Affirmative Action Employer. This literature is subject to all applicable copyright laws and is not for resale in any manner.

## PUBLICATION ORDERING INFORMATION

### LITERATURE FULFILLMENT:

Literature Distribution Center for ON Semiconductor  
19521 E. 32nd Pkwy, Aurora, Colorado 80011 USA  
**Phone:** 303-675-2175 or 800-344-3860 Toll Free USA/Canada  
**Fax:** 303-675-2176 or 800-344-3867 Toll Free USA/Canada  
**Email:** [orderlit@onsemi.com](mailto:orderlit@onsemi.com)

**N. American Technical Support:** 800-282-9855 Toll Free  
USA/Canada  
**Europe, Middle East and Africa Technical Support:**  
Phone: 421 33 790 2910  
**Japan Customer Focus Center**  
Phone: 81-3-5817-1050

**ON Semiconductor Website:** [www.onsemi.com](http://www.onsemi.com)  
**Order Literature:** <http://www.onsemi.com/orderlit>  
For additional information, please contact your local  
Sales Representative

# Mouser Electronics

Authorized Distributor

Click to View Pricing, Inventory, Delivery & Lifecycle Information:

[ON Semiconductor:](#)

[FPF1009](#)

Компания «Life Electronics» занимается поставками электронных компонентов импортного и отечественного производства от производителей и со складов крупных дистрибьюторов Европы, Америки и Азии.

С конца 2013 года компания активно расширяет линейку поставок компонентов по направлению коаксиальный кабель, кварцевые генераторы и конденсаторы (керамические, пленочные, электролитические), за счёт заключения дистрибьюторских договоров

Мы предлагаем:

- Конкурентоспособные цены и скидки постоянным клиентам.
- Специальные условия для постоянных клиентов.
- Подбор аналогов.
- Поставку компонентов в любых объемах, удовлетворяющих вашим потребностям.
- Приемлемые сроки поставки, возможна ускоренная поставка.
- Доставку товара в любую точку России и стран СНГ.
- Комплексную поставку.
- Работу по проектам и поставку образцов.
- Формирование склада под заказчика.
- Сертификаты соответствия на поставляемую продукцию (по желанию клиента).
- Тестирование поставляемой продукции.
- Поставку компонентов, требующих военную и космическую приемку.
- Входной контроль качества.
- Наличие сертификата ISO.

В составе нашей компании организован Конструкторский отдел, призванный помогать разработчикам, и инженерам.

Конструкторский отдел помогает осуществить:

- Регистрацию проекта у производителя компонентов.
- Техническую поддержку проекта.
- Защиту от снятия компонента с производства.
- Оценку стоимости проекта по компонентам.
- Изготовление тестовой платы монтаж и пусконаладочные работы.



Тел: +7 (812) 336 43 04 (многоканальный)

Email: [org@lifeelectronics.ru](mailto:org@lifeelectronics.ru)