

FRACTIONAL-N PLL WITH INTEGRATED VCO, 1285 - 1415 MHz



Features

- RF Bandwidth: 1285 to 1415 MHz
- Ultra Low Phase Noise
-108 dBc/Hz in Band Typ.
- Figure of Merit (FOM) -227 dBc
- 24-bit Step Size, Resolution 3 Hz typ
- < 180 fs RMS Jitter
- Exact Frequency Mode
- Built-in Digital Self Test
- 40 Lead 6x6mm SMT Package: 36mm²

Typical Applications

- Cellular/4G Infrastructure
- Repeaters and Femtocells
- Communications Test Equipment
- CATV Equipment
- Phased Array Applications
- DDS Replacement
- Very High Data Rate Radios

Functional Diagram

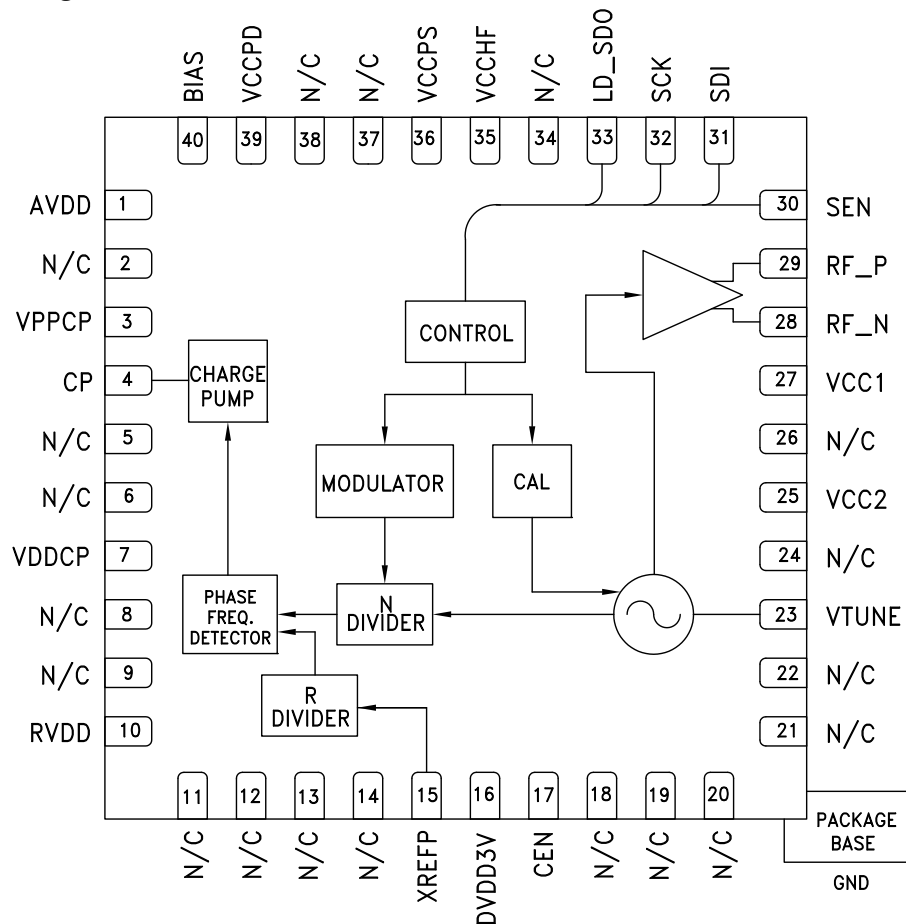

Information furnished by Analog Devices is believed to be accurate and reliable. However, no responsibility is assumed by Analog Devices for its use, nor for any infringements of patents or other rights of third parties that may result from its use. Specifications subject to change without notice. No license is granted by implication or otherwise under any patent or patent rights of Analog Devices. Trademarks and registered trademarks are the property of their respective owners.

For price, delivery, and to place orders: Analog Devices, Inc., One Technology Way, P.O. Box 9106, Norwood, MA 02062-9106 Phone: 781-329-4700 • Order online at www.analog.com Application Support: Phone: 1-800-ANALOG-D



FRACTIONAL-N PLL WITH INTEGRATED VCO, 1285 - 1415 MHz

General Description

The HMC828LP6CE is a fully functioned Fractional-N Phase-Locked-Loop (PLL) with an Integrated Voltage Controlled Oscillator (VCO). The PLL consists of an integrated low noise VCO with divide-by-2 output, an autocalibration subsystem for low voltage VCO tuning, a very low noise digital Phase Detector (PD), a precision controlled charge pump, a low noise reference path divider and a fractional divider.

The fractional PLL features an advanced delta-sigma modulator design that allows both ultra-fine step sizes and low spurious products. The phase detector (PD) features cycle slip prevention (CSP) technology to allow faster frequency hopping times. Ultra low in-close phase noise and low spurious also allows wider loop bandwidths for faster frequency hopping and low micro-phonics.

For theory of operation and register map refer to the “PLLs with Integrated VCOs - RF VCOs Operating Guide”. To view the Operating Guide, please visit www.hittite.com and choose HMC828LP6CE from the “Search by Part Number” pull down menu.

Electrical Specifications, $T_A = +25^\circ\text{C}$

VPPCP, VDDCP, VCC1, VCC2 = 5V ±4%; RVDD, AVDD, DVDD3V, VCCPD, VCCHF, VCCPS = 3.3V ±6% GNDCP = GNDLS = Ground Paddle = 0V

Parameter	Condition	Min.	Typ.	Max.	Units
RF Output Characteristics					
VCO Frequency at PLL Input		1285		1415	MHz
RF Output Frequency at f_{VCO}		1285		1415	MHz
RF Output Power at f_{VCO}		7	10	13	dBm
VCO Tuning Sensitivity	Measured at 2 GHz, 2V		15		MHz/V
VCO Supply Pushing	Measured at 2 GHz, 2V	-2		1.5	MHz/V
RF Output 2nd Harmonic			-25		dBc
RF Output 3rd Harmonic			-23		dBc
RF Output 4th Harmonic			-31		dBc
RF Divider Characteristics					
19-Bit N-Divider Range (Integer)	Max = $2^{19} - 1$	16		524,287	
19-Bit N-Divider Range (Fractional)	Fractional nominal divide ratio varies (-3 / +4) dynamically max	20		524,283	
REF Input Characteristics					
Max Ref Input Frequency	Synthesizer phase noise can degrade by about 5 dB when operating with a reference frequency near the low end of this range.	10	50	200	MHz
Ref Input Range	AC Coupled	1.5	2	3.3	Vpp
Ref Input Capacitance				5	pF
14-Bit R-Divider Range		1		16,383	
Phase Detector (PD)					
PD Frequency Fractional Feedback Mode	[1]	0.1		100	MHz
PD Frequency Fractional Feedforward Mode (and Register 6 [17:16] = 10)		0.1		80	MHz
PD Frequency Integer Mode	[1]	0.1		125	MHz

Note 1: This maximum phase detector frequency can only be achieved if the minimum N value is respected. eg. In the case of fractional feedback mode, the maximum PFD rate = $f_{vco}/20$ or 100 MHz, whichever is less.



FRACTIONAL-N PLL WITH INTEGRATED VCO, 1285 - 1415 MHz

Electrical Specifications (Continued)

Parameter	Condition	Min.	Typ.	Max.	Units
Charge Pump					
Max Output Current		0.02		2.54	mA
Charge Pump Gain Step Size (5-Bits)			20		μA
PD/Charge Pump SSB Phase Noise	50 MHz Ref, Input Referred				
1 kHz			-141		dBc/Hz
10 kHz	Add 1 dB for Fractional		-149		dBc/Hz
100 kHz	Add 3 dB for Fractional		-153		dBc/Hz
Logic Inputs					
VIH Input High Voltage		DVDD3V-0.4		DVDD3V	V
VIL Input Low Voltage		0		0.4	V
Logic Outputs					
VOH Output High Voltage		DVDD3V-0.4		DVDD3V	V
VOL Output Low Voltage		0		0.4	V
Power Supply Voltages					
Analog 3.3V Supplies	AVDD, VCCHF, VCCPS, VCCPD, RVDD	3.0	3.3	3.5	V
Digital Supply	DVDD3V	3.0	3.3	3.5	V
Analog 5V Supplies	VPPCP, VDDCP, VCC1, VCC2	4.8	5	5.2	V
Power Supply Currents					
+5V Analog Charge Pump	VPPCP, VDDCP		5.3		mA
+5V VCO Core and PLL Buffer	VCC2		56		mA
+5V VCO Divider and RF Buffer	VCC1		36		mA
+3.3V Analog	AVDD, VCCHF, VCCPS, VCCPD, RVDD		45		mA
+3.3V Digital	DVDD3V		6.5		mA
Power Down - Crystal Off	Reg 01h=0, Crystal Not Clocked		10		μA
Power Down - Crystal On, 100 MHz	Reg 01h=0, Crystal Clocked 100 MHz		10	200	μA
Power on Reset					
Typical Reset Voltage on DVDD			700		mV
Min DVDD Voltage for No Reset		1.5			V
Power on Reset Delay			250		μs
VCO Open Loop Phase Noise at fo					
10 kHz Offset			-88		dBc/Hz
100 kHz Offset			-118		dBc/Hz
1 MHz Offset			-143	-141	dBc/Hz
10 MHz Offset			-162		dBc/Hz
100 MHz Offset			-168		dBc/Hz
Closed Loop Phase Noise PLL + VCO at fo					
Integer, 50 MHz PFD	1 kHz Offset		-105		dBc/Hz
Integer, 50 MHz PFD	10 kHz Offset		-112		dBc/Hz
Integer, 50 MHz PFD	100 kHz Offset		-120		dBc/Hz

Information furnished by Analog Devices is believed to be accurate and reliable. However, no responsibility is assumed by Analog Devices for its use, nor for any infringements of patents or other rights of third parties that may result from its use. Specifications subject to change without notice. No license is granted by implication or otherwise under any patent or patent rights of Analog Devices. Trademarks and registered trademarks are the property of their respective owners.

For price, delivery, and to place orders: Analog Devices, Inc., One Technology Way, P.O. Box 9106, Norwood, MA 02062-9106
 Phone: 781-329-4700 • Order online at www.analog.com
 Application Support: Phone: 1-800-ANALOG-D



FRACTIONAL-N PLL WITH INTEGRATED VCO, 1285 - 1415 MHz

Electrical Specifications (Continued)

Parameter	Condition	Min.	Typ.	Max.	Units
Fractional, 50 MHz PFD	1 kHz Offset		-103		dBc/Hz
Fractional, 50 MHz PFD	10 kHz Offset		-107		dBc/Hz
Fractional, 50 MHz PFD	100 kHz Offset		-112		dBc/Hz
Figure of Merit	Normalized 1 Hz				
Integer Mode	Measured w/ 50 MHz PD at 30 kHz Offset		-229		dBc/Hz
Fractional Mode	Measured w/ 50 MHz PD at 30 kHz Offset		-227		dBc/Hz

Closed Loop Integer Phase Noise

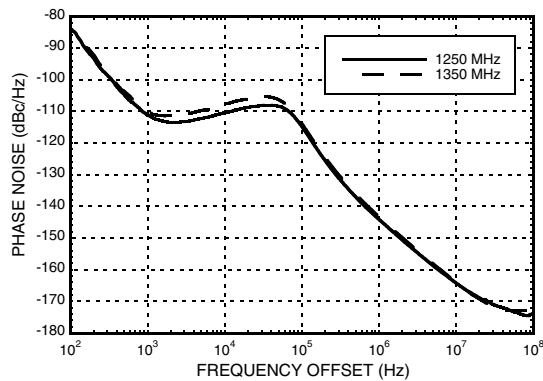

Typical Closed Loop Fractional Phase Noise [1]

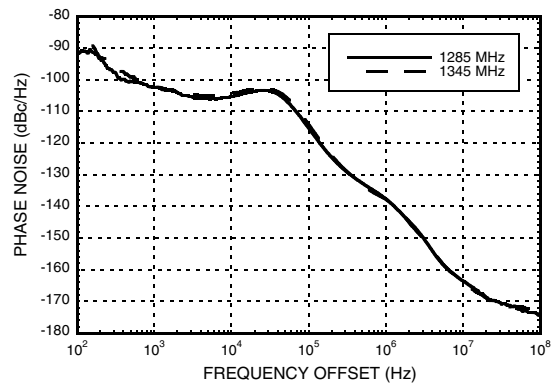

VCO Free Running Phase Noise

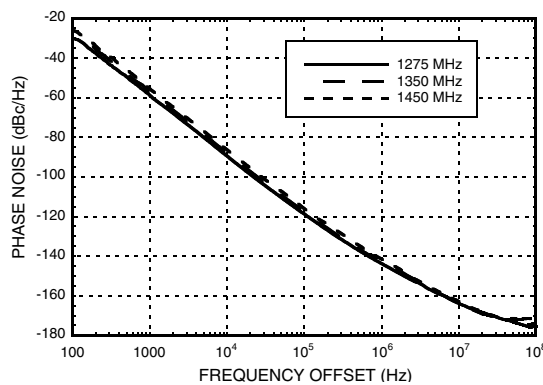

Typical VCO Tuning Curves vs. Switch Position

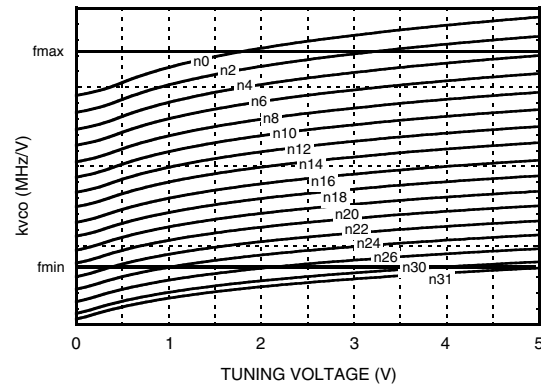

[1] Fractional Mode, 50 MHz Crystal, R=1, ~80 kHz Loop BW, (Loop filter values: Contact factory for component values) 2mA Charge Pump, -385µA Offset.



FRACTIONAL-N PLL WITH INTEGRATED VCO, 1285 - 1415 MHz

Free Running VCO Phase Noise (V_{TUNE} Set by AutoCal)

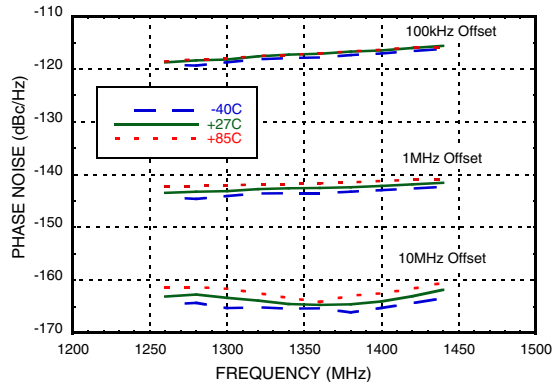

Typical VCO Tuning Voltage After Calibration

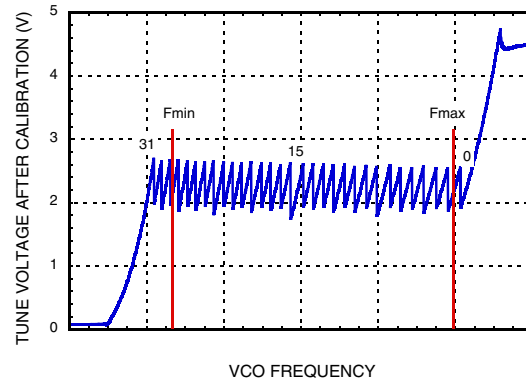

Typical VCO Sensitivity vs. Cap @ Fo Voltage

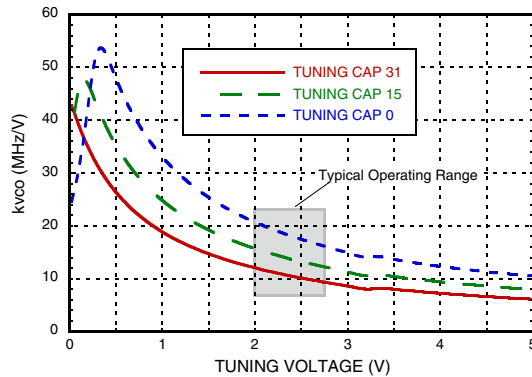

Typical Output Power - Narrow Band Match

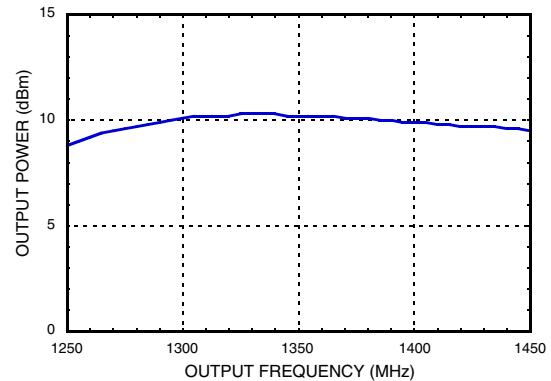
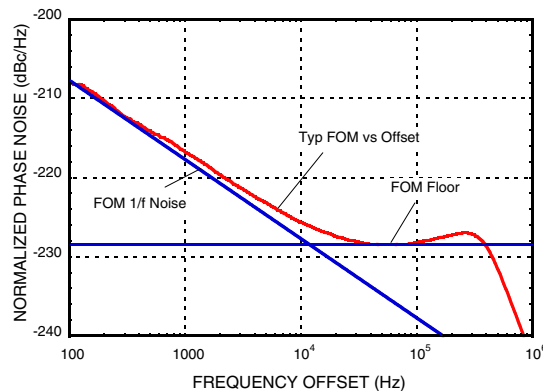

Figure of Merit



[1] Fractional Mode, 50 MHz Crystal, R=1, ~80 kHz Loop BW, (Loop filter values: Contact factory for component values) 2mA Charge Pump, -385µA Offset.

Information furnished by Analog Devices is believed to be accurate and reliable. However, no responsibility is assumed by Analog Devices for its use, nor for any infringements of patents or other rights of third parties that may result from its use. Specifications subject to change without notice. No license is granted by implication or otherwise under any patent or patent rights of Analog Devices. Trademarks and registered trademarks are the property of their respective owners.

For price, delivery, and to place orders: Analog Devices, Inc., One Technology Way, P.O. Box 9106, Norwood, MA 02062-9106 Phone: 781-329-4700 • Order online at www.analog.com Application Support: Phone: 1-800-ANALOG-D

**FRACTIONAL-N PLL WITH
INTEGRATED VCO, 1285 - 1415 MHz**
Pin Descriptions

Pin Number	Function	Description
1	AVDD	DC Power Supply for analog circuitry.
2, 5, 6, 8, 9, 11 - 14, 18 - 22, 24, 26, 34, 37, 38	N/C	The pins are not connected internally; however, all data shown herein was measured with these pins connected to RF/DC ground externally.
3	VPPCP	Power Supply for charge pump analog section
4	CP	Charge Pump Output
7	VDDCP	Power Supply for the charge pump digital section
10	RVDD	Reference Supply
15	XREFP	Reference Oscillator Input
16	DVDD3V	DC Power Supply for Digital (CMOS) Circuitry
17	CEN	Chip Enable. Connect to logic high for normal operation.
23	VTUNE	VCO Varactor. Tuning Port Input.
25	VCC2	VCO Analog Supply 2
27	VCC1	VCO Analog Supply 1
28	RF_N	VCO Divide by 2 RF Positive Output
29	RF_P	VCO Divide by 2 RF Negative Output
30	SEN	PLL Serial Port Enable (CMOS) Logic Input
31	SDI	PLL Serial Port Data (CMOS) Logic Input
32	SCK	PLL Serial Port Clock (CMOS) Logic Input
33	LD_SDO	Lock Detect, or Serial Data, or General Purpose (CMOS) Logic Output (GPO)
35	VCCHF	DC Power Supply for Analog Circuitry
36	VCCPS	DC Power Supply for Analog Prescaler
39	VCCPD	DC Power Supply for Phase Detector
40	BIAS	External bypass decoupling for precision bias circuits. Note: 1.920V \pm 20mV reference voltage (BIAS) is generated internally and cannot drive an external load. Must be measured with 10G Ω meter such as Agilent 34410A, normal 10M Ω DVM will read erroneously.



FRACTIONAL-N PLL WITH INTEGRATED VCO, 1285 - 1415 MHz

Absolute Maximum Ratings

AVDD, RVDD, DVDD3V, VCCPD, VCCHF, VCCPS	-0.3V to +3.6V
VPPCP, VDDCP, VCC1	-0.3V to +5.8V
VCC2	-0.3V to +5.5V
Operating Temperature	-40°C to +85°C
Storage Temperature	-65°C to 125°C
Maximum Junction Temperature	125 °C
Thermal Resistance (R _{TH}) (junction to ground paddle)	20 °C/W
Reflow Soldering	
Peak Temperature	260°C
Time at Peak Temperature	40 sec
ESD Sensitivity (HBM)	Class 1B

Stresses above those listed under Absolute Maximum Ratings may cause permanent damage to the device. This is a stress rating only; functional operation of the device at these or any other conditions above those indicated in the operational section of this specification is not implied. Exposure to absolute maximum rating conditions for extended periods may affect device reliability.

Outline Drawing

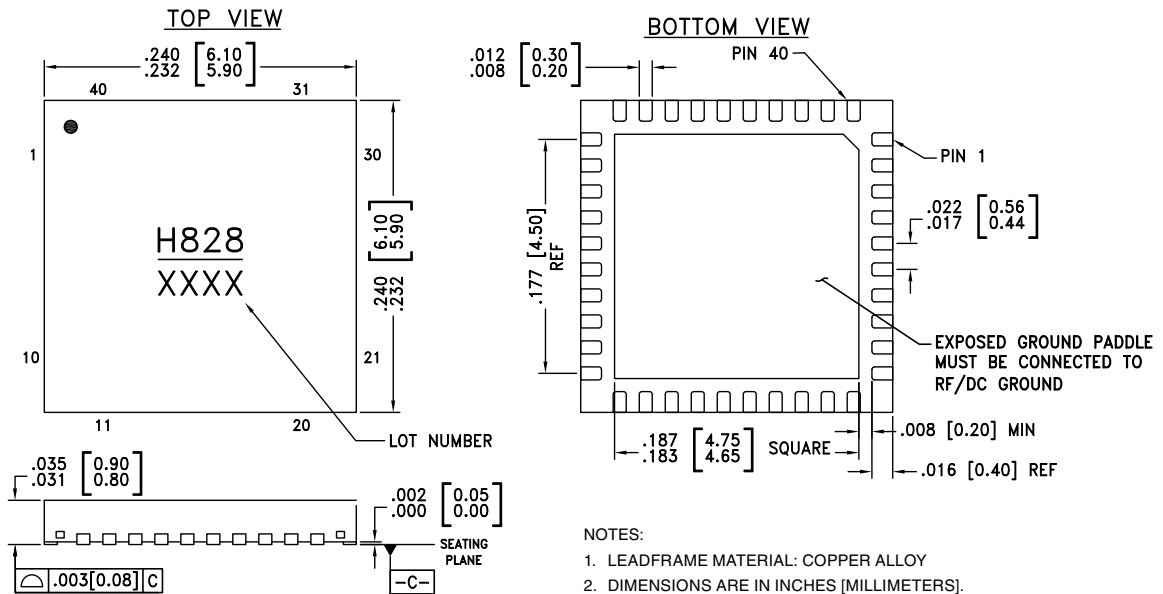

Package Information

Part Number	Package Body Material	Lead Finish	MSL Rating	Package Marking ^[1]
HMC828LP6CE	RoHS-compliant Low Stress Injection Molded Plastic	100% matte Sn	MSL1	H828 XXXX

[1] 4-Digit lot number XXXX



**FRACTIONAL-N PLL WITH
INTEGRATED VCO, 1285 - 1415 MHz**

Evaluation PCB

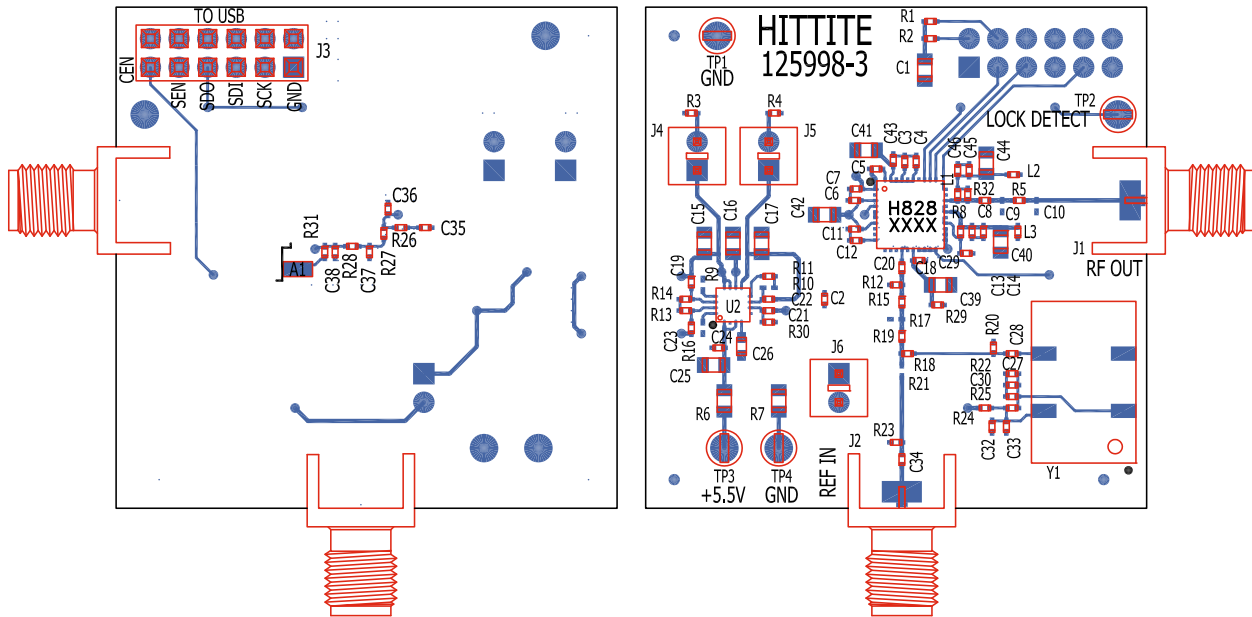

The circuit board used in the application should use RF circuit design techniques. Signal lines should have 50 Ohm impedance while the package ground leads and exposed paddle should be connected directly to the ground plane similar to that shown. A sufficient number of via holes should be used to connect the top and bottom ground planes. The evaluation circuit board shown is available from Hittite upon request.

Evaluation PCB Schematic

To view this [Evaluation PCB Schematic](http://www.hittite.com) please visit www.hittite.com and choose HMC828LP6CE from the "Search by Part Number" pull down menu to view the product splash page.

Information furnished by Analog Devices is believed to be accurate and reliable. However, no responsibility is assumed by Analog Devices for its use, nor for any infringements of patents or other rights of third parties that may result from its use. Specifications subject to change without notice. No license is granted by implication or otherwise under any patent or patent rights of Analog Devices. Trademarks and registered trademarks are the property of their respective owners.

For price, delivery, and to place orders: Analog Devices, Inc., One Technology Way, P.O. Box 9106, Norwood, MA 02062-9106 Phone: 781-329-4700 • Order online at www.analog.com Application Support: Phone: 1-800-ANALOG-D

**FRACTIONAL-N PLL WITH
INTEGRATED VCO, 1285 - 1415 MHz**
List of Materials for Evaluation PCB 127830 [1]

Item	Description
J1, J2	PCB Mount SMA RF Connector
J3	Dual Row Terminal Strip
J4 - J6	Connector Header
C1, C15 - C17, C25	10 μ F Capacitor, 0805 Pkg.
C2, C3, C6, C7, C11, C12, C14, C18, C27, C43, C45	0.47 μ F Capacitor, 0402 Pkg.
C4, C13	22 pF Capacitor, 0402 Pkg.
C5, C33	1000 pF Capacitor, 0402 Pkg.
C8	2.2 pF Capacitor, 0402 Pkg.
C19 - C24, C28, C30, C32, C34	0.1 μ F Capacitor, 0402 Pkg.
C26	1.0 μ F Capacitor, 0603 Pkg.
C29	47 pF Capacitor, 0402 Pkg.
C35	3300 pF Capacitor, 0402 Pkg.
C36	270 pF Capacitor, 0402 Pkg.
C37, C38	68 pF Capacitor, 0402 Pkg.
C39 - C42, C44	4.7 μ F Tantalum Capacitor, 0805 Pkg
R1, R2, R5, R11, R15, R18, R19, R21, R24	0 Ohm Resistor, 0402 Pkg.
R3, R4	1 Ohm Resistor, 0402 Pkg.
R6, R7	0 Ohm Resistor, 0805 Pkg.
R8	22 Ohm Resistor, 0402 Pkg.
R12, R20, R29	51 Ohm Resistor, 0402 Pkg.
R22, R25	20 kOhm Resistor, 0402 Pkg.
R26 - R28	1k Ohm Resistor, 0402 Pkg.
L1	6.8 nH Inductor, 0402 Pkg.
TP3, TP4	Test Point PC Compact SMT
U1	HMC828LP6CE PLL with Integrated VCO
U2	HMC860LP3E Low Noise Quad Linear Regulator
Y1	3.3V, 50 MHz VCXO Crystal Oscillator
PCB [2]	125998 Evaluation Board

[1] Reference this number when ordering complete evaluation PCB

[2] Circuit Board Material: Rogers 4350 or Arlon 25FR and FR4

**FRACTIONAL-N PLL WITH
INTEGRATED VCO, 1285 - 1415 MHz****Notes:**

Компания «Life Electronics» занимается поставками электронных компонентов импортного и отечественного производства от производителей и со складов крупных дистрибьюторов Европы, Америки и Азии.

С конца 2013 года компания активно расширяет линейку поставок компонентов по направлению коаксиальный кабель, кварцевые генераторы и конденсаторы (керамические, пленочные, электролитические), за счёт заключения дистрибьюторских договоров

Мы предлагаем:

- Конкурентоспособные цены и скидки постоянным клиентам.
- Специальные условия для постоянных клиентов.
- Подбор аналогов.
- Поставку компонентов в любых объемах, удовлетворяющих вашим потребностям.
- Приемлемые сроки поставки, возможна ускоренная поставка.
- Доставку товара в любую точку России и стран СНГ.
- Комплексную поставку.
- Работу по проектам и поставку образцов.
- Формирование склада под заказчика.
- Сертификаты соответствия на поставляемую продукцию (по желанию клиента).
- Тестирование поставляемой продукции.
- Поставку компонентов, требующих военную и космическую приемку.
- Входной контроль качества.
- Наличие сертификата ISO.

В составе нашей компании организован Конструкторский отдел, призванный помогать разработчикам, и инженерам.

Конструкторский отдел помогает осуществить:

- Регистрацию проекта у производителя компонентов.
- Техническую поддержку проекта.
- Защиту от снятия компонента с производства.
- Оценку стоимости проекта по компонентам.
- Изготовление тестовой платы монтаж и пусконаладочные работы.



Тел: +7 (812) 336 43 04 (многоканальный)

Email: org@lifeelectronics.ru