

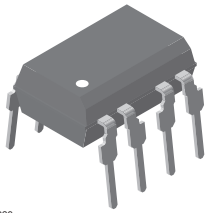

# High Speed Optocoupler, Dual Channel, 1 MBd, Transistor Output

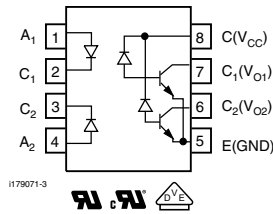

i179026



## FEATURES

- Isolation test voltage, 5300 V<sub>RMS</sub>
- TTL compatible
- Bit rates: 1 MBit/s
- High common mode transient immunity
- Bandwidth 2 MHz
- Open collector output
- Compliant to RoHS Directive 2002/95/EC and in accordance to WEEE 2002/96/EC



RoHS COMPLIANT

## DESCRIPTION

The SFH6325 and SFH6326 are dual channel optocouplers with a GaAlAs infrared emitting diode, optically coupled with an integrated photo detector which consists of a photo diode and a high-speed transistor in a DIP-8 plastic package. Signals can be transmitted between two electrically separated circuits up to frequencies of 2 MHz. The potential difference between the circuits to be coupled should not exceed the maximum permissible reference voltages.

## AGENCY APPROVALS

- UL1577, file no. E52744 system code H double protection
- cUL tested to CSA 22.2 bulletin 5A
- DIN EN 60747-5-2 (VDE0884)/DIN EN 60747-5-5 (pending), available with option 1

## ORDERING INFORMATION

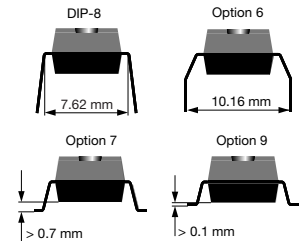
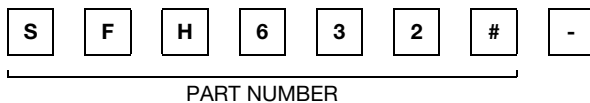

AGENCY CERTIFIED/PACKAGE	CTR (%)	
	≥ 7	≥ 19
UL, cUL		
DIP-8	SFH6325	SFH6326
DIP-8, 400 mil, option 6	-	SFH6326-X006
SMD-8, option 7	-	SFH6326-X007T <sup>(1)</sup>
SMD-8, option 9	SFH6325-X009T <sup>(1)</sup>	SFH6326-X009T <sup>(1)</sup>
VDE, UL, cUL		
DIP-8	-	SFH6326-X001
SMD-8, option 7	SFH6325-X017T	SFH6326-X017T <sup>(1)</sup>

### Note

- Additional options may be possible, please contact sales office.
- <sup>(1)</sup> Also available in tubes; do not add T to end.

## ABSOLUTE MAXIMUM RATINGS (T<sub>amb</sub> = 25 °C, unless otherwise specified)

PARAMETER	TEST CONDITION	SYMBOL	VALUE	UNIT
<b>INPUT</b>				
Reverse voltage		V <sub>R</sub>	4.5	V
Forward continuous current		I <sub>F</sub>	25	mA
Peak forward current	t = 1 ms, duty cycle 50 %	I <sub>FM</sub>	50	mA
Maximum surge forward current	t ≤ 1 μs, 300 pulses/s	I <sub>FSM</sub>	1	A
Derate linearly from 25 °C			0.6	mW/°C
Power dissipation	T <sub>amb</sub> ≤ 70 °C	P <sub>diss</sub>	50	mW



ABSOLUTE MAXIMUM RATINGS ( $T_{amb} = 25\text{ }^{\circ}\text{C}$ , unless otherwise specified)				
PARAMETER	TEST CONDITION	SYMBOL	VALUE	UNIT
<b>OUTPUT</b>				
Supply voltage		$V_S$	- 0.5 to 30	V
Output voltage		$V_O$	- 0.5 to 25	V
Collector output current		$I_{CO}$	8	mA
Derate linearly from 25 °C			1.33	mW/°C
Power dissipation	$T_{amb} \leq 70\text{ }^{\circ}\text{C}$	$P_{diss}$	50	mW
<b>COUPLER</b>				
Isolation test voltage	$t = 1\text{ s}$	$V_{ISO}$	5300	$V_{RMS}$
Pollution degree (DIN VDE0109)			2	
Creepage distance			$\geq 7$	mm
Clearance distance			$\geq 7$	mm
Derate linearly from 25 °C			1.93	mW/°C
Total package dissipation		$P_{tot}$	145	mW
Comparative tracking index per DIN IEC112/VDE0303 part 1, group IIIa per DIN VDE6110			175	
Isolation resistance	$V_{IO} = 500\text{ V}, T_{amb} = 25\text{ }^{\circ}\text{C}$	$R_{IO}$	$\geq 10^{12}$	$\Omega$
	$V_{IO} = 500\text{ V}, T_{amb} = 100\text{ }^{\circ}\text{C}$	$R_{IO}$	$\geq 10^{11}$	$\Omega$
Storage temperature range		$T_{stg}$	- 55 to + 125	°C
Ambient temperature range		$T_{amb}$	- 55 to +100	°C
Soldering temperature <sup>(1)</sup>	max. 10 s, dip soldering distance to seating plane $\geq 1.5\text{ mm}$	$T_{slid}$	260	°C

**Notes**

- Stresses in excess of the absolute maximum ratings can cause permanent damage to the device. Functional operation of the device is not implied at these or any other conditions in excess of those given in the operational sections of this document. Exposure to absolute maximum ratings for extended periods of the time can adversely affect reliability.

<sup>(1)</sup> Refer to reflow profile for soldering conditions for surface mounted devices (SMD). Refer to wave profile for soldering conditions for through hole devices (DIP).

ELECTRICAL CHARACTERISTICS ( $T_{amb} = 25\text{ }^{\circ}\text{C}$ , unless otherwise specified)							
PARAMETER	TEST CONDITION	PART	SYMBOL	MIN.	TYP.	MAX.	UNIT
<b>INPUT <sup>(1)</sup></b>							
Forward voltage	$I_F = 16\text{ mA}$		$V_F$		1.33	1.9	V
Breakdown voltage	$I_R = 10\text{ }\mu\text{A}$		$V_{BR}$	4.5			V
Reverse current	$V_R = 4.5\text{ V}$		$I_R$		0.5	10	$\mu\text{A}$
Capacitance	$V_R = 0\text{ V}, f = 1\text{ MHz}$		$C_O$		30		pF
Temperature coefficient of forward voltage	$I_F = 16\text{ mA}$		$\Delta V_F/\Delta T_{amb}$		- 1.7		mV/°C
<b>OUTPUT</b>							
Logic low supply current	$I_F = 16\text{ mA}, V_O = \text{open}, V_{CC} = 4.5\text{ V}$		$I_{CCL}$		100	200	$\mu\text{A}$
Supply current, logic high	$I_F = 0\text{ mA}, V_O = \text{open}, V_{CC} = 15\text{ V}$		$I_{CCH}$		0.01	4	$\mu\text{A}$
Logic low output voltage	$I_F = 16\text{ mA}, V_{CC} = 4.5\text{ V}, I_O = 1.1\text{ mA}$	SFH6325	$V_{OL}$		0.1	0.5	V
	$I_F = 16\text{ mA}, V_{CC} = 4.5\text{ V}, I_O = 3\text{ mA}$	SFH6326	$V_{OL}$		0.1	0.5	V
Logic high output current	$I_F = 0\text{ mA}, V_O = V_{CC} = 5.5\text{ V}$		$I_{OH}$		3	500	nA
	$I_F = 0\text{ mA}, V_O = V_{CC} = 15\text{ V}$		$I_{OH}$			50	$\mu\text{A}$
Channel to channel <sup>(2)</sup> crosstalk	$I_F = 16\text{ mA}, V_O = V_{CC} = 5.5\text{ V}$		$I_{OH-XT}$			500	nA
<b>COUPLER</b>							
Capacitance (input to output)	$f = 1\text{ MHz}$		$C_{IO}$		0.6		pF

**Notes**

- Minimum and maximum values are testing requirements. Typical values are characteristics of the device and are the result of engineering evaluation. Typical values are for information only and are not part of the testing requirements.

<sup>(1)</sup>  $T_{amb} = 0\text{ }^{\circ}\text{C}$  to  $70\text{ }^{\circ}\text{C}$ , unless otherwise specified.

<sup>(2)</sup> To measure crosstalk, turn on the LED for channel 1 and the output current for channel 2 in logic high. Repeat for channel 2.

<b>CURRENT TRANSFER RATIO</b> ( $T_{amb} = 25\text{ }^{\circ}\text{C}$ , unless otherwise specified)							
PARAMETER	TEST CONDITION	PART	SYMBOL	MIN.	TYP.	MAX.	UNIT
Current transfer ratio	$I_F = 16\text{ mA}$ , $V_{CC} = 4.5\text{ V}$ , $V_O = 0.4\text{ V}$ , $T_{amb} = 25\text{ }^{\circ}\text{C}$	SFH6325	CTR	7	16		%
		SFH6326	CTR	19	35		%
	$I_F = 16\text{ mA}$ , $V_{CC} = 4.5\text{ V}$ , $V_O = 0.5\text{ V}$ , $T_{amb} = 0\text{ }^{\circ}\text{C}$ to $70\text{ }^{\circ}\text{C}$	SFH6325	CTR	5			%
		SFH6326	CTR	15			%

<b>SWITCHING CHARACTERISTICS</b> ( $T_{amb} = 25\text{ }^{\circ}\text{C}$ , unless otherwise specified)							
PARAMETER	TEST CONDITION	PART	SYMBOL	MIN.	TYP.	MAX.	UNIT
High to low	$I_F = 16\text{ mA}$ , $V_{CC} = 5\text{ V}$ , $R_L = 4.1\text{ k}\Omega$	SFH6325	$t_{PHL}$		0.3	1.5	$\mu\text{s}$
	$I_F = 16\text{ mA}$ , $V_{CC} = 5\text{ V}$ , $R_L = 1.9\text{ k}\Omega$	SFH6326	$t_{PHL}$		0.2	0.8	$\mu\text{s}$
Low to high	$I_F = 16\text{ mA}$ , $V_{CC} = 5\text{ V}$ , $R_L = 4.1\text{ k}\Omega$	SFH6325	$t_{PLH}$		0.6	1.5	$\mu\text{s}$
	$I_F = 16\text{ mA}$ , $V_{CC} = 5\text{ V}$ , $R_L = 1.9\text{ k}\Omega$	SFH6326	$t_{PLH}$		0.5	0.8	$\mu\text{s}$

<b>COMMON MODE TRANSIENT IMMUNITY</b> ( $T_{amb} = 25\text{ }^{\circ}\text{C}$ , unless otherwise specified)							
PARAMETER	TEST CONDITION	PART	SYMBOL	MIN.	TYP.	MAX.	UNIT
CMTI at logic high level output	$I_F = 0\text{ mA}$ , $C_{CM} = 10\text{ V}_{P-P}$ , $V_{CC} = 5\text{ V}$ , $R_L = 4.1\text{ k}\Omega$	SFH6325	$CM_H$		1000		$\text{V}/\mu\text{s}$
	$I_F = 0\text{ mA}$ , $C_{CM} = 10\text{ V}_{P-P}$ , $V_{CC} = 5\text{ V}$ , $R_L = 1.9\text{ k}\Omega$	SFH6326	$CM_H$		1000		$\text{V}/\mu\text{s}$
CMTI at logic low level output	$I_F = 16\text{ mA}$ , $C_{CM} = 10\text{ V}_{P-P}$ , $V_{CC} = 5\text{ V}$ , $R_L = 4.1\text{ k}\Omega$	SFH6325	$CM_L$		1000		$\text{V}/\mu\text{s}$
	$I_F = 16\text{ mA}$ , $C_{CM} = 10\text{ V}_{P-P}$ , $V_{CC} = 5\text{ V}$ , $R_L = 1.9\text{ k}\Omega$	SFH6326	$CM_L$		1000		$\text{V}/\mu\text{s}$

**TYPICAL CHARACTERISTICS** ( $T_{amb} = 25\text{ }^{\circ}\text{C}$ , unless otherwise specified)

Fig. 1 - LED Forward Current vs. Forward Voltage

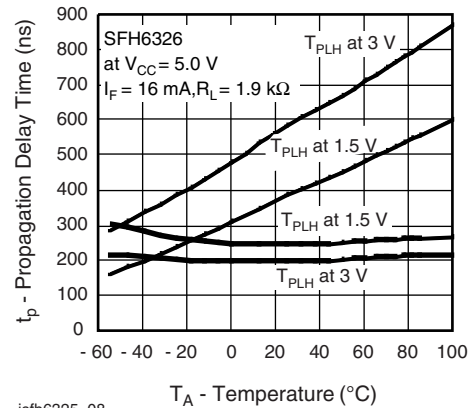

Fig. 2 - Permissible Forward LED Current vs. Temperature



isfh6325\_05

Fig. 3 - Permissible Power Dissipation vs. Temperature



isfh6325\_08

Fig. 6 - Propagation Delay vs. Ambient Temperature



isfh6325\_06

Fig. 4 - Output Current vs. Output Voltage



isfh6325\_09

Fig. 7 - Propagation Delay vs. Ambient Temperature



isfh6325\_07

Fig. 5 - Output Current vs. Temperature

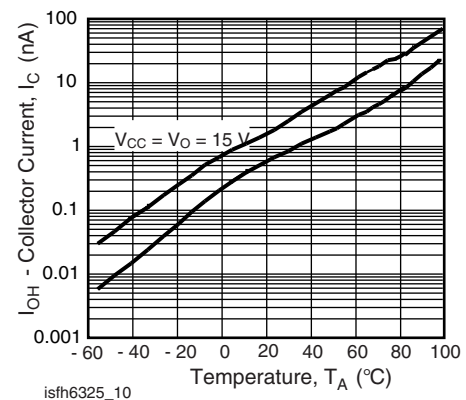

isfh6325\_10

Fig. 8 - Logic High Output Current vs. Temperature



Fig. 9 - Small Signal Current Transfer Ratio vs. Input Current

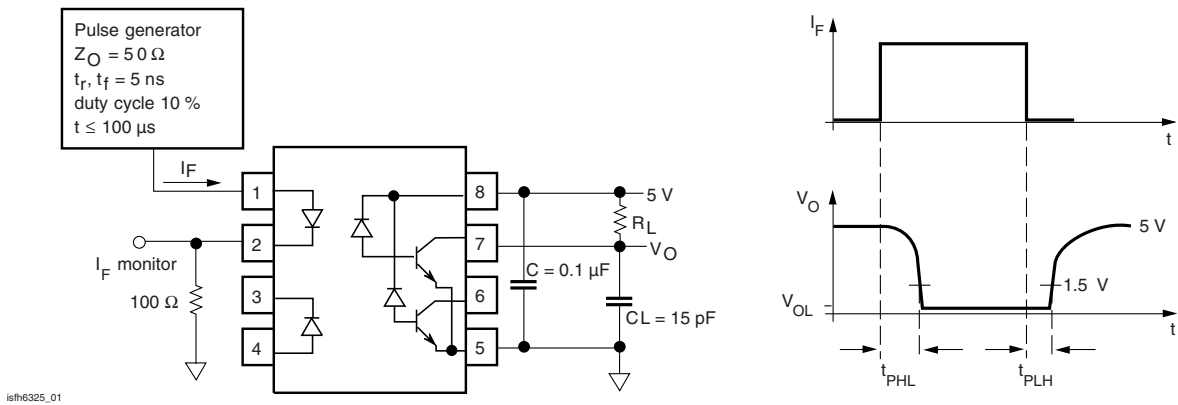

Fig. 10 - Switching Time and Test Circuit



Fig. 11 - Waveform and Test Circuit for Common Mode Transient Immunity

## PACKAGE DIMENSIONS in millimeters



i178006



18450

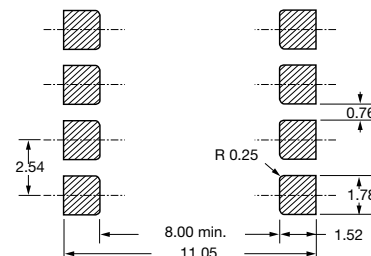

## PACKAGE MARKING



21764-69

### Notes

- Only options 1 and 7 are reflected in the package marking.
- The VDE Logo is only marked on option1 parts.
- Tape and reel suffix (T) is not part of the package marking.



## Disclaimer

ALL PRODUCT, PRODUCT SPECIFICATIONS AND DATA ARE SUBJECT TO CHANGE WITHOUT NOTICE TO IMPROVE RELIABILITY, FUNCTION OR DESIGN OR OTHERWISE.

Vishay Intertechnology, Inc., its affiliates, agents, and employees, and all persons acting on its or their behalf (collectively, "Vishay"), disclaim any and all liability for any errors, inaccuracies or incompleteness contained in any datasheet or in any other disclosure relating to any product.

Vishay makes no warranty, representation or guarantee regarding the suitability of the products for any particular purpose or the continuing production of any product. To the maximum extent permitted by applicable law, Vishay disclaims (i) any and all liability arising out of the application or use of any product, (ii) any and all liability, including without limitation special, consequential or incidental damages, and (iii) any and all implied warranties, including warranties of fitness for particular purpose, non-infringement and merchantability.

Statements regarding the suitability of products for certain types of applications are based on Vishay's knowledge of typical requirements that are often placed on Vishay products in generic applications. Such statements are not binding statements about the suitability of products for a particular application. It is the customer's responsibility to validate that a particular product with the properties described in the product specification is suitable for use in a particular application. Parameters provided in datasheets and/or specifications may vary in different applications and performance may vary over time. All operating parameters, including typical parameters, must be validated for each customer application by the customer's technical experts. Product specifications do not expand or otherwise modify Vishay's terms and conditions of purchase, including but not limited to the warranty expressed therein.

Except as expressly indicated in writing, Vishay products are not designed for use in medical, life-saving, or life-sustaining applications or for any other application in which the failure of the Vishay product could result in personal injury or death. Customers using or selling Vishay products not expressly indicated for use in such applications do so at their own risk. Please contact authorized Vishay personnel to obtain written terms and conditions regarding products designed for such applications.

No license, express or implied, by estoppel or otherwise, to any intellectual property rights is granted by this document or by any conduct of Vishay. Product names and markings noted herein may be trademarks of their respective owners.

## Material Category Policy

**Vishay Intertechnology, Inc. hereby certifies that all its products that are identified as RoHS-Compliant fulfill the definitions and restrictions defined under Directive 2011/65/EU of The European Parliament and of the Council of June 8, 2011 on the restriction of the use of certain hazardous substances in electrical and electronic equipment (EEE) - recast, unless otherwise specified as non-compliant.**

**Please note that some Vishay documentation may still make reference to RoHS Directive 2002/95/EC. We confirm that all the products identified as being compliant to Directive 2002/95/EC conform to Directive 2011/65/EU.**

**Vishay Intertechnology, Inc. hereby certifies that all its products that are identified as Halogen-Free follow Halogen-Free requirements as per JEDEC JS709A standards. Please note that some Vishay documentation may still make reference to the IEC 61249-2-21 definition. We confirm that all the products identified as being compliant to IEC 61249-2-21 conform to JEDEC JS709A standards.**

Компания «Life Electronics» занимается поставками электронных компонентов импортного и отечественного производства от производителей и со складов крупных дистрибьюторов Европы, Америки и Азии.

С конца 2013 года компания активно расширяет линейку поставок компонентов по направлению коаксиальный кабель, кварцевые генераторы и конденсаторы (керамические, пленочные, электролитические), за счёт заключения дистрибьюторских договоров

Мы предлагаем:

- Конкурентоспособные цены и скидки постоянным клиентам.
- Специальные условия для постоянных клиентов.
- Подбор аналогов.
- Поставку компонентов в любых объемах, удовлетворяющих вашим потребностям.
- Приемлемые сроки поставки, возможна ускоренная поставка.
- Доставку товара в любую точку России и стран СНГ.
- Комплексную поставку.
- Работу по проектам и поставку образцов.
- Формирование склада под заказчика.
- Сертификаты соответствия на поставляемую продукцию (по желанию клиента).
- Тестирование поставляемой продукции.
- Поставку компонентов, требующих военную и космическую приемку.
- Входной контроль качества.
- Наличие сертификата ISO.

В составе нашей компании организован Конструкторский отдел, призванный помогать разработчикам, и инженерам.

Конструкторский отдел помогает осуществить:

- Регистрацию проекта у производителя компонентов.
- Техническую поддержку проекта.
- Защиту от снятия компонента с производства.
- Оценку стоимости проекта по компонентам.
- Изготовление тестовой платы монтаж и пусконаладочные работы.



Тел: +7 (812) 336 43 04 (многоканальный)

Email: [org@lifeelectronics.ru](mailto:org@lifeelectronics.ru)