

ADJUSTABLE PRECISION ZENER SHUNT REGULATOR

ISSUE 4 – SEPTEMBER 2000

ZR431

DEVICE DESCRIPTION

The ZR431 is a three terminal adjustable shunt regulator offering excellent temperature stability and output current handling capability up to 100mA. The output voltage may be set to any chosen voltage between 2.5 and 20 volts by selection of two external divider resistors.

The devices can be used as a replacement for zener diodes in many applications requiring an improvement in zener performance.

FEATURES

- Surface mount SO8, SOT223 and SOT23 packages
- TO92 package
- 2%, 1 % and 0.5% tolerance
- Max. temperature coefficient 55 ppm/°C
- Temperature compensated for operation over the full temperature range
- Programmable output voltage
- 50 μ A to 100mA current sink capability
- Low output noise

APPLICATIONS

- Shunt regulator
- Series regulator
- Voltage monitor
- Over voltage/ under voltage protection
- Switch mode power supplies

SCHEMATIC DIAGRAM

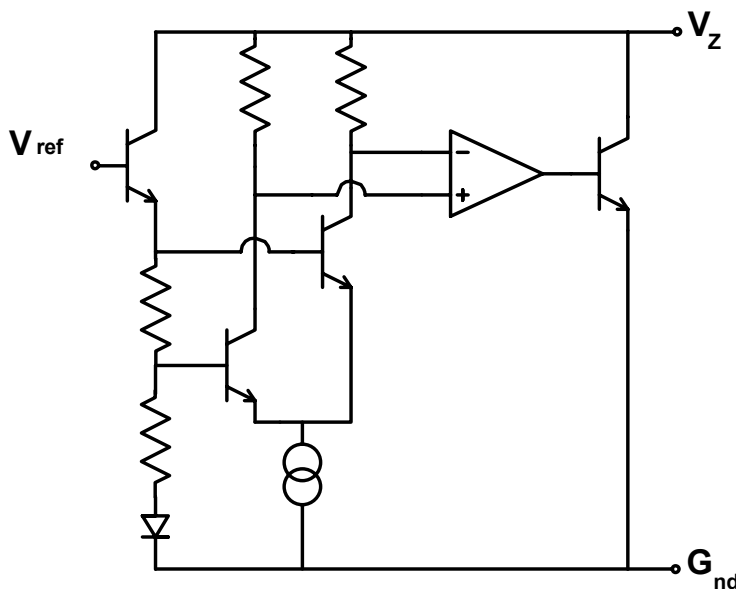

ZR431

ABSOLUTE MAXIMUM RATING

Cathode Voltage (V_Z)	20V
Cathode Current	150mA
Operating Temperature	-40 to 85°C
Storage Temperature	-55 to 125°C

Power Dissipation ($T_{amb}=25^\circ\text{C}, T_{jmax}=150^\circ\text{C}$)

SOT23	330mW
TO92	780mW
SOT223	2W
SO8	780mW

Recommended Operating Conditions

	Min	Max
Cathode Voltage	V_{ref}	20V
Cathode Current	50 μA	100mA

ELECTRICAL CHARACTERISTICS TEST CONDITIONS (Unless otherwise stated): $T_{amb}=25^\circ\text{C}$

PARAMETER	SYMBOL	VALUE			UNITS	CONDITIONS
		MIN	TYP	MAX		
Reference Voltage	2% 1% (¹)0.5% V_{ref}	2.45	2.50	2.55	V	$I_L=10\text{mA}$ (Fig1), $V_Z=V_{ref}$
		2.475	2.50	2.525		
		2.489	2.50	2.513		
Deviation of Reference Input Voltage over Temperature	V_{dev}		8.0	17	mV	$I_L=10\text{mA}$, $V_Z=V_{ref}$ $T_a=\text{full range}$ (Fig1)
Ratio of the change in Reference Voltage to the Change in Cathode Voltage	$\frac{\Delta V_{ref}}{\Delta V_Z}$		-1.85	-2.7	mV/V	V_Z from V_{ref} to 10V $I_Z=10\text{mA}$ (Fig2)
			-1.0	-2.0	mV/V	V_Z from 10V to 20V $I_Z=10\text{mA}$ (Fig2)
Reference Input Current	I_{ref}		0.12	1.0	μA	$R1=10\text{k}$, $R2=O/C$, $I_L=10\text{mA}$ (Fig2)
Deviation of Reference Input Current over Temperature	ΔI_{ref}		0.04	0.2	μA	$R1=10\text{k}$, $R2=O/C$, $I_L=10\text{mA}$ $T_a=\text{full range}$ (Fig2)
Minimum Cathode Current for Regulation	I_{Zmin}		35	50	μA	$V_Z=V_{ref}$ (Fig1)
Off-state Current	I_{Zoff}			0.1	μA	$V_Z=20\text{V}$, $V_{ref}=0\text{V}$ (Fig3)
Dynamic Output Impedance	R_Z			0.75	Ω	$V_Z=V_{ref}$ (Fig1), $f=0\text{Hz}$

(¹) 0.5% SOT23 only.

For definitions of reference voltage temperature coefficient and dynamic output impedance see NOTES following DC TEST CIRCUITS



ZR431

TYPICAL CHARACTERISTICS

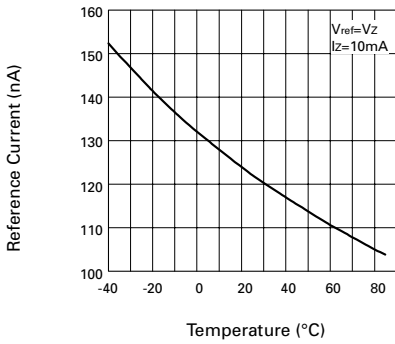

Reference Current v Temperature

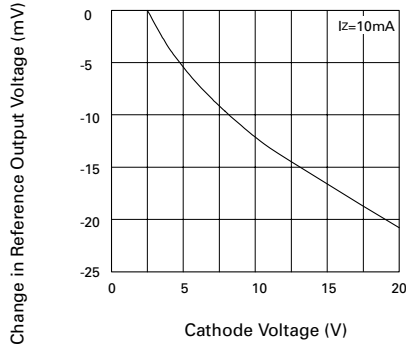

Change in Vref v Cathode Voltage

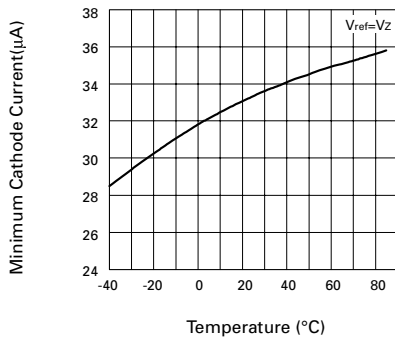

Cathode Current v Temperature

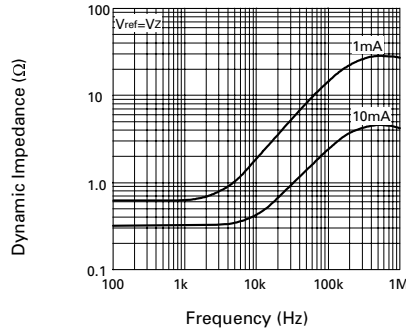

Dynamic Impedance v Frequency

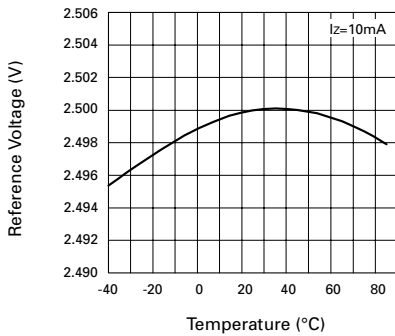

Reference Voltage v Temperature

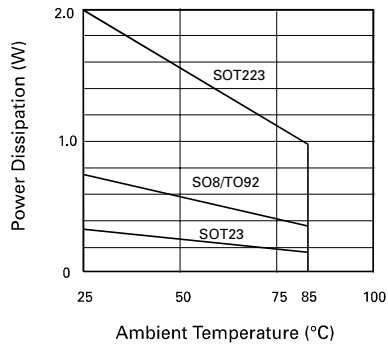

Power Dissipation Derating

ZR431

TYPICAL CHARACTERISTICS

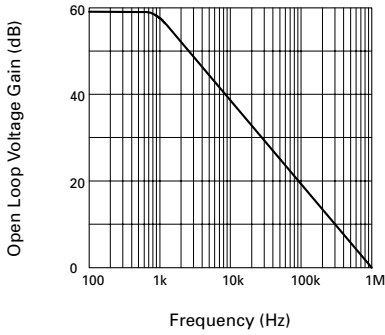

Gain v Frequency

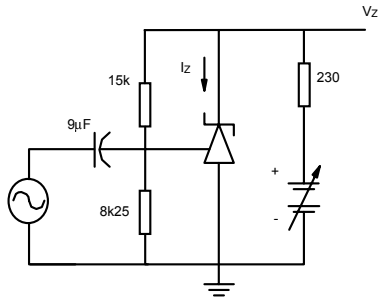

Test Circuit for Open Loop Voltage Gain

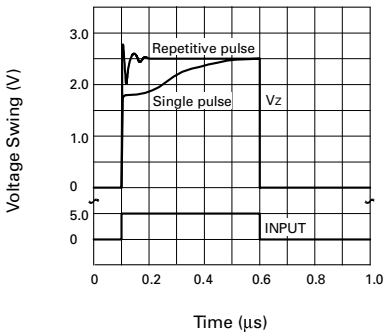

Pulse Response

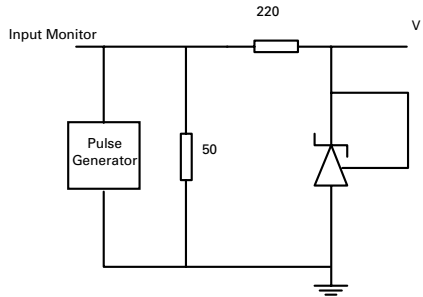

Test Circuit for Pulse Response

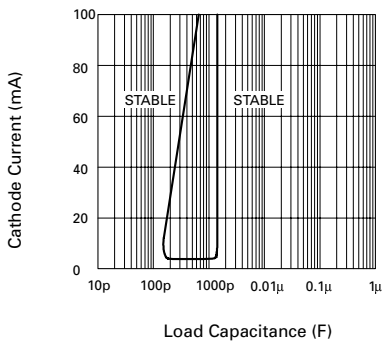

Stability Boundary Conditions

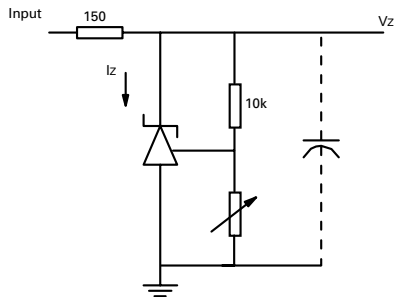

Test Circuit for Stability Boundary Conditions

ZR431

APPLICATION CIRCUITS

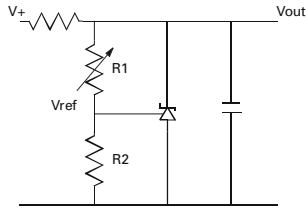

$$V_{out} = \left(1 + \frac{R1}{R2}\right) V_{ref}$$

SHUNT REGULATOR

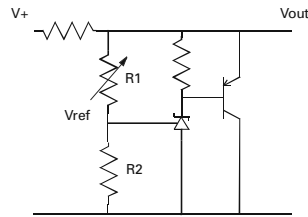

$$V_{out} = \left(1 + \frac{R1}{R2}\right) V_{ref}$$

HIGHER CURRENT SHUNT REGULATOR

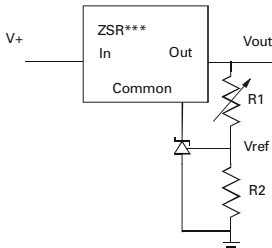

$$V_{out,MIN} = V_{ref} + V_{reg}$$

$$V_{out} = \left(1 + \frac{R1}{R2}\right) V_{ref}$$

OUTPUT CONTROL OF A THREE TERMINAL FIXED REGULATOR

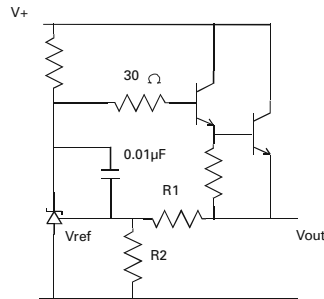

$$V_{out} = \left(1 + \frac{R1}{R2}\right) V_{ref}$$

SERIES REGULATOR

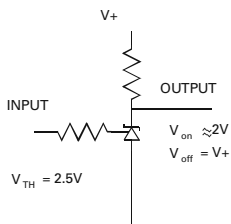

SINGLE SUPPLY COMPARETOR WITH TEMPERATURE COMPENSATED THRESHOLD

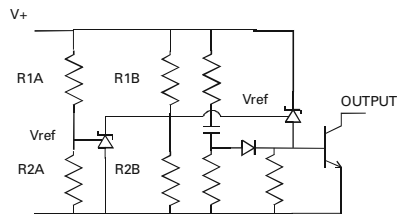

$$\text{Low limit} = \left(1 + \frac{R1B}{R2B}\right) V_{ref}$$

$$\text{High limit} = \left(1 + \frac{R1A}{R2A}\right) V_{ref}$$

OVER VOLTAGE / UNDER VOLTAGE PROTECTION CIRCUIT

ZR431

DC TEST CIRCUITS

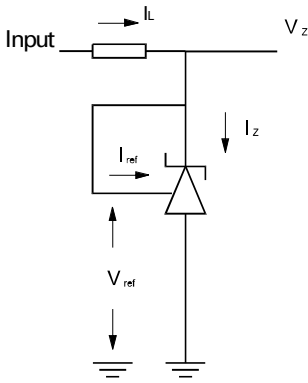

Fig 1 – Test Circuit for $V_z=V_{ref}$

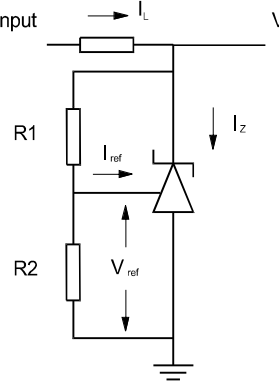

Fig 2 – Test Circuit for $V_z>V_{ref}$

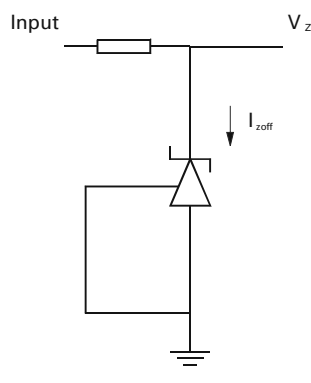
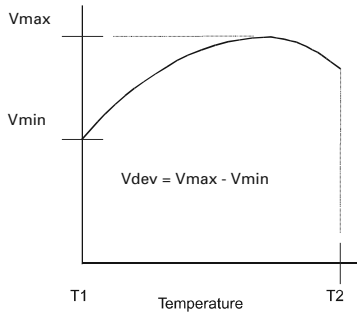

Fig 3 – Test Circuit for Off State current

NOTES

Deviation of reference input voltage, V_{dev} , is defined as the maximum variation of the reference input voltage over the full temperature range.

The average temperature coefficient of the reference input voltage, V_{ref} is defined as:



$$V_{ref} (ppm/^{\circ}C) = \frac{V_{dev} \times 1000000}{V_{ref} (T1 - T2)}$$

The dynamic output impedance, R_z , is defined as:

$$R_z = \frac{\Delta V_z}{\Delta I_z}$$

When the device is programmed with two external resistors, R_1 and R_2 , (fig 2), the dynamic output impedance of the overall circuit, R' , is defined as:

$$R' = R_z \left(1 + \frac{R_1}{R_2}\right)$$

ZR431

CONNECTION DIAGRAMS

SO8 Package Suffix - N8

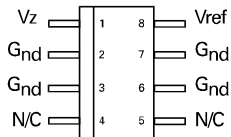

Top View

SOT223 Package Suffix - G

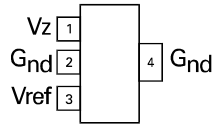

Top View -
Pin 4 floating or connected to pin 2

SOT23 Package Suffix - F

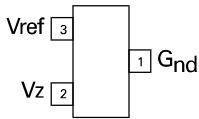

Top View

TO92 Package Suffix - C

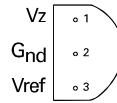

Bottom View

ORDERING INFORMATION

Part Number	Package	Tol. %	Part Mark
ZR431C01	TO92	1.0	ZR43101
ZR431C	TO92	2.0	ZR431
ZR431G01	SOT223	1.0	ZR43101
ZR431G	SOT223	2.0	ZR431
ZR431F005	SOT23	0.5	43R
ZR431F01	SOT23	1.0	43B
ZR431F	SOT23	2.0	43A
ZR431N801	SO8	1.0	ZR43101
ZR431N8	SO8	2.0	ZR431

Компания «Life Electronics» занимается поставками электронных компонентов импортного и отечественного производства от производителей и со складов крупных дистрибьюторов Европы, Америки и Азии.

С конца 2013 года компания активно расширяет линейку поставок компонентов по направлению коаксиальный кабель, кварцевые генераторы и конденсаторы (керамические, пленочные, электролитические), за счёт заключения дистрибьюторских договоров

Мы предлагаем:

- Конкурентоспособные цены и скидки постоянным клиентам.
- Специальные условия для постоянных клиентов.
- Подбор аналогов.
- Поставку компонентов в любых объемах, удовлетворяющих вашим потребностям.
- Приемлемые сроки поставки, возможна ускоренная поставка.
- Доставку товара в любую точку России и стран СНГ.
- Комплексную поставку.
- Работу по проектам и поставку образцов.
- Формирование склада под заказчика.
- Сертификаты соответствия на поставляемую продукцию (по желанию клиента).
- Тестирование поставляемой продукции.
- Поставку компонентов, требующих военную и космическую приемку.
- Входной контроль качества.
- Наличие сертификата ISO.

В составе нашей компании организован Конструкторский отдел, призванный помогать разработчикам, и инженерам.

Конструкторский отдел помогает осуществить:

- Регистрацию проекта у производителя компонентов.
- Техническую поддержку проекта.
- Защиту от снятия компонента с производства.
- Оценку стоимости проекта по компонентам.
- Изготовление тестовой платы монтаж и пусконаладочные работы.



Тел: +7 (812) 336 43 04 (многоканальный)

Email: org@lifeelectronics.ru